



**DoctorAbad**  
سرزمین علوم پزشکی کشور

# ژنتیک امری

✓ موضوع: ژنتیک

✓ نویسنده: Peter D. Turnpenny

✓ تک جلدی

✓ نسخه ۲۰۱۷

✓ ویرایش پانزدهم

✓ ۴۱۰ صفحه

✓ زبان: لاتین

[www.DoctorAbad.com](http://www.DoctorAbad.com)





Emery's  
**ELEMENTS** *of*  
**MEDICAL GENETICS**

edition  
**15**

Peter Turnpenny • Sian Ellard

ELSEVIER



# Emery's ELEMENTS OF MEDICAL GENETICS

edition  
**15**

**Peter D. Turnpenny** BSc MB ChB FRCP FRCPCH FRCPath FHEA

Consultant Clinical Geneticist,  
Royal Devon and Exeter NHS Foundation Trust,  
*and*  
Honorary Clinical Professor,  
University of Exeter Medical School

**Sian Ellard** BSc PhD FRCPath

Consultant Clinical Molecular Geneticist,  
Royal Devon and Exeter NHS Foundation Trust,  
*and*  
Professor of Molecular Genetics and Genomic Medicine,  
University of Exeter Medical School

For additional online content visit

[StudentConsult.com](http://StudentConsult.com)

ELSEVIER

ELSEVIER

© 2017, 2012, 2007, 2005, 2001, 1998, 1995, 1992, 1988, 1983, 1979, 1975, 1974, 1971, 1968, Elsevier Limited. All rights reserved.

The right of Peter D. Turnpenney and Sian Ellard to be identified as authors of this work has been asserted by them in accordance with the Copyright, Designs, and Patents Act 1988.

No part of this publication may be reproduced or transmitted in any form or by any means, electronic or mechanical, including photocopying, recording, or any information storage and retrieval system, without permission in writing from the publisher. Details on how to seek permission, further information about the Publisher's permissions policies and our arrangements with organizations such as the Copyright Clearance Center and the Copyright Licensing Agency, can be found at our website: [www.elsevier.com/permissions](http://www.elsevier.com/permissions).

This book and the individual contributions contained in it are protected under copyright by the Publisher (other than as may be noted herein).

#### Notices

Knowledge and best practice in this field are constantly changing. As new research and experience broaden our understanding, changes in research methods, professional practices, or medical treatment may become necessary.

Practitioners and researchers must always rely on their own experience and knowledge in evaluating and using any information, methods, compounds, or experiments described herein. In using such information or methods they should be mindful of their own safety and the safety of others, including parties for whom they have a professional responsibility.

With respect to any drug or pharmaceutical products identified, readers are advised to check the most current information provided (i) on procedures featured or (ii) by the manufacturer of each product to be administered, to verify the recommended dose or formula, the method and duration of administration, and contraindications. It is the responsibility of practitioners, relying on their own experience and knowledge of their patients, to make diagnoses, to determine dosages and the best treatment for each individual patient, and to take all appropriate safety precautions.

To the fullest extent of the law, neither the Publisher nor the authors, contributors, or editors, assume any liability for any injury and/or damage to persons or property as a matter of products liability, negligence or otherwise, or from any use or operation of any methods, products, instructions, or ideas contained in the material herein.

ISBN: 978-0-7020-6685-6

Content Strategist: Pauline Graham  
Content Development Specialist: Alexandra Mortimer  
Project Manager: Anne Collett  
Design: Christian Billbow  
Illustration Manager: Karen Giacomucci  
Illustrator: Robert Britton  
Marketing Manager: Melissa Darling

Printed in China

Last digit is the print number: 9 8 7 6 5 4 3 2 1



# Contents

Preface	viii
Acknowledgments	ix
Dedication	x

<b>1 The History and Impact of Genetics in Medicine</b>	<b>1</b>
Gregor Mendel and the Laws of Inheritance	1
DNA as the Basis of Inheritance	3
The Fruit Fly	4
The Origins of Medical Genetics	4
The Impact of Genetic Disease	6
Major New Developments	6
The Societal Impact of Advances in Genetics	8

## SECTION A THE SCIENTIFIC BASIS OF HUMAN GENETICS

<b>2 The Cellular and Molecular Basis of Inheritance</b>	<b>9</b>
The Cell	9
DNA: The Hereditary Material	9
Chromosome Structure	10
Types of DNA Sequence	11
Transcription	14
Translation	15
The Genetic Code	16
Regulation of Gene Expression	16
RNA-Directed DNA Synthesis	17
Mutations	17
Mutations and Mutagenesis	21
<b>3 Chromosomes and Cell Division</b>	<b>24</b>
Human Chromosomes	24
Methods of Chromosome Analysis	26
Molecular Cytogenetics	27
Chromosome Nomenclature	28
Cell Division	29
Gametogenesis	32
Chromosome Abnormalities	33
<b>4 Finding the Cause of Monogenic Disorders by Identifying Disease Genes</b>	<b>42</b>
Position-Independent Identification of Human Disease Genes	42
Positional Cloning	43

The Human Genome Project	44
Identifying the Genetic Etiology of Monogenic Disorders by Next-Generation Sequencing	47

<b>5 Laboratory Techniques for Diagnosis of Monogenic Disorders</b>	<b>50</b>
PCR (Polymerase Chain Reaction)	50
Application of DNA Sequence Polymorphisms	50
Nucleic Acid Hybridization Techniques	52
Mutation Detection	54
Sequencing-Based Methods	57
Dosage Analysis	60
Towards Genome Sequencing as a Clinical Diagnostic Test	64
<b>6 Patterns of Inheritance</b>	<b>66</b>
Family Studies	66
Mendelian Inheritance	66
Multiple Alleles and Complex Traits	75
Anticipation	75
Mosaicism	76
Uniparental Disomy	77
Genomic Imprinting	77
Mitochondrial Inheritance	80
<b>7 Population and Mathematical Genetics</b>	<b>83</b>
Allele Frequencies in Populations	83
Genetic Polymorphism	88
Segregation Analysis	88
Genetic Linkage	89
Medical and Societal Intervention	92
Conclusion	93
<b>8 Risk Calculation</b>	<b>94</b>
Probability Theory	94
Autosomal Dominant Inheritance	95
Autosomal Recessive Inheritance	97
Sex-Linked Recessive Inheritance	98
The Use of Linked Markers	99
Bayes' Theorem and Prenatal Screening	99
Empiric Risks	100
<b>9 Developmental Genetics</b>	<b>102</b>
Fertilization and Gastrulation	102
Developmental Gene Families	103
The Pharyngeal Arches	114
The Role of Cilia in Developmental Abnormalities	115

- The Limb as a Developmental Model 115
- Developmental Genes and Cancer 119
- Positional Effects and Developmental Genes 121
- Hydatidiform Moles 121
- Epigenetics and Development 121
- Sex Determination and Disorders of Sex Development 123
- Twinning 127

## SECTION B GENETICS IN MEDICINE AND GENOMIC MEDICINE

- 10 Common Disease, Polygenic and Multifactorial Genetics 130**
  - Types and Mechanisms of Genetic Susceptibility 130
  - Approaches to Demonstrating Genetic Susceptibility to Common Diseases 131
  - Polygenic Inheritance and the Normal Distribution 132
  - Multifactorial Inheritance—the Liability/Threshold Model 133
  - Identifying Genes That Cause Multifactorial Disorders 134
  - Disease Models for Multifactorial Inheritance 137
- 11 Screening for Genetic Disease 144**
  - Screening Those at High Risk 144
  - Carrier Testing for Autosomal Recessive and X-Linked Disorders 144
  - Presymptomatic Diagnosis of Autosomal Dominant Disorders 145
  - Ethical Considerations in Carrier Detection and Predictive Testing 147
  - Population Screening 147
  - Criteria for a Screening Program 148
  - Prenatal and Postnatal Screening 149
  - Population Carrier Screening 151
  - Genetic Registers 152
- 12 Hemoglobin and the Hemoglobinopathies 154**
  - Structure of Hb 154
  - Developmental Expression of Hemoglobin 154
  - Globin Chain Structure 155
  - Synthesis and Control of Hemoglobin Expression 156
  - Disorders of Hemoglobin 156
  - Clinical Variation of the Hemoglobinopathies 161
  - Antenatal and Newborn Hemoglobinopathy Screening 162
- 13 Immunogenetics 164**
  - Immunity 164
  - Innate Immunity 164
  - Specific Acquired Immunity 166
  - Inherited Immunodeficiency Disorders 171
  - Blood Groups 174

- 14 The Genetics of Cancer...and Cancer Genetics 177**
  - Differentiation Between Genetic and Environmental Factors in Cancer 177
  - Oncogenes 179
  - Tumor Suppressor Genes 182
  - Epigenetics and Cancer 185
  - Genetics of Common Cancers 186
  - DNA Tumor Profiling and Mutation Signatures 188
  - Genetic Counseling in Familial Cancer 193
- 15 Pharmacogenetics, Personalized Medicine and the Treatment of Genetic Disease 200**
  - Pharmacogenetics 200
  - Drug Metabolism 200
  - Genetic Variations Revealed by the Effects of Drugs 201
  - Personalized Medicine 202
  - Treatment of Genetic Disease 204
  - Therapeutic Applications of Recombinant DNA Technology 206
  - Gene Therapy 207
  - RNA Modification 210
  - Targeted Gene Correction 210
  - Stem Cell Therapy 210

## SECTION C CLINICAL GENETICS, COUNSELING, AND ETHICS

- 16 Congenital Abnormalities, Dysmorphic Syndromes, and Learning Disability 215**
  - Incidence 215
  - Definition and Classification of Birth Defects 216
  - Genetic Causes of Malformations 219
  - Environmental Agents (Teratogens) 225
  - Malformations of Unknown Cause 228
  - Counseling 229
  - Learning Disability 229
- 17 Chromosome Disorders 236**
  - Incidence of Chromosome Abnormalities 236
  - Disorders of the Sex Chromosomes 239
  - ‘Classic’ Chromosome Deletion Syndromes 243
  - Microarray-CGH 245
  - Chromosome Disorders and Behavioral Phenotypes 250
  - Chromosomal Breakage Syndromes 250
  - Indications for Chromosomal/Microarray-CGH Analysis 253
- 18 Inborn Errors of Metabolism 255**
  - Disorders of Amino Acid and Peptide Metabolism 255
  - Disorders of Carbohydrate Metabolism 260
  - Disorders of Steroid Metabolism 261
  - Disorders of Lipid and Lipoprotein Metabolism 262

- Lysosomal Storage Disorders 263
- Disorders in the Metabolism of Purines, Pyrimidines, and Nucleotides 265
- Disorders of Porphyrin and Heme Metabolism 266
- Disorders in the Metabolism of Trace Elements and Metals 266
- Peroxisomal Disorders 268
- Disorders of Fatty Acid and Ketone Body Metabolism 269
- Disorders of Energy Metabolism 269
- Prenatal Diagnosis of Inborn Errors of Metabolism 271
- 19 Mainstream Monogenic Disorders 273**
  - Neurological Disorders 273
  - The Hereditary Ataxias 274
  - Inherited Peripheral Neuropathies 275
  - Motor Neurone Disease (MND) 278
  - Neurocutaneous Disorders 278
  - Muscular Dystrophies 281
  - Respiratory Disorders 286
  - Inherited Cardiac Conditions (ICCs) 289
  - Connective Tissue Disorders 291
  - Renal Disorders 296
  - Blood Disorders 298
- 20 Prenatal Testing and Reproductive Genetics 303**
  - Techniques Used in Prenatal Diagnosis 303
  - Prenatal Screening 306
  - Indications for Prenatal Testing 309
  - Special Problems in Prenatal Diagnosis 311
  - Termination of Pregnancy 312
  - Preimplantation Genetic Diagnosis 313
- Assisted Conception and Implications for Genetic Disease 313
- Non-Invasive Prenatal Testing (NIPT) 314
- Prenatal Treatment 315
- 21 Genetic Counseling 317**
  - Definition 317
  - Establishing the Diagnosis 317
  - Calculating and Presenting the Risk 318
  - Discussing the Options 319
  - Communication and Support 319
  - Genetic Counseling—Directive or Non-Directive? 319
  - Outcomes in Genetic Counseling 319
  - Special Issues in Genetic Counseling 320
- 22 Ethical and Legal Issues in Medical Genetics 323**
  - General Principles 323
  - Ethical Dilemmas in the Genetics Clinic 325
  - Ethical Dilemmas and the Public Interest 327
  - Conclusion 330
- Glossary 332**
- Appendix: Websites and Clinical Databases 349**
- Multiple-Choice Questions 351**
- Case-Based Questions 360**
- Multiple-Choice Answers 365**
- Case-Based Answers 375**
- Index 382**

# Preface

*“Reading maketh a full man; conference a ready man; and writing an exact man.”*

**Francis Bacon (1561–1626)**

It is more than five years since we last updated *Emery's Elements* and the task of producing a new edition has seemed bigger and more daunting than ever. For the last edition we mentioned the incoming technology of *next generation sequencing* and the impact it was beginning to have on solving long-standing diagnostic conundrums, especially in a research environment. Already, just a few years later, we owe so much to the scientists and bioinformaticians who make the technology work for patients and families affected by genetic disease. Gene discovery for rare disease has risen exponentially as a result, and we now routinely request ‘panel’ tests for different phenotypes—whether for conditions of the RAS-MAPK pathway or inherited eye disease—anything from 20 to 200 genes. So, next generation sequencing is now very much a clinical and service tool as well, yielding a higher rate of diagnoses, and often at a price that is not much more than the cost of testing one gene in the past.

Whole exome or whole genome sequencing has given birth to a huge field of ethical debate within and beyond the professions concerning ‘what to do’ with *secondary* or *incidental findings* that have health implications. Europe and North America are not always aligned in their views and practice in these difficult areas, so the issues will continue to be discussed and contested at length.

To these developments can be added the rapidly developing applications of non-invasive prenatal testing and screening, as well as nuclear cell transfer with mitochondrial donation to treat some families devastated by mitochondrial disease. Advances in the use of genetic technologies for assisted reproduction always provoke debate and controversy with entrenched, polarized views frequently pitted against each other in the media. As we write this, the most recent advance to feature in this way is the use of *gene editing*, or *CRISPR*, technology in the treatment of genetic disease. Together with other novel approaches, there is more expectation than ever before that families affected by genetic disease will in due course benefit from treatment strategies judiciously applied.

We have made some major changes to this edition in our efforts to bring it up to date. We have re-ordered the chapters to a format that we believe is more logical and appropriate, referred repeatedly to the use of new technologies, and added much new clinical material to broaden its appeal as a basic text. As before, we hope this will prove useful to undergraduates and postgraduates alike, and help them swim rather than sink when tackling the mysteries of medical genetics.

**Peter Turnpenny and Sian Ellard**  
Exeter, United Kingdom



## Acknowledgments

As always, we feel privileged to be working in an area of healthcare science and service that continues to be exciting and captivating as the technologies and knowledge move forward so inexorably. We work within teams and networks of very talented colleagues who are similarly inspired and, even though unaware, they contribute to this volume through their knowledge, professional companionship and encouragement. For this edition we particularly thank Dr Anna Murray (University of

Exeter Medical School) who helped with the merger of chapters into the new 'Common disease, Polygenic and Multifactorial Genetics'. This edition includes a large number of new clinical images, for which we must once again thank our patients who have been so willing to share themselves in this way. We are grateful to Elsevier, especially Alexandra Mortimer, for her guidance and patience, particularly as several deadlines came and went!

## Dedication

To Alan Emery, a friend, mentor, and constant source of inspiration and encouragement.



Alan E. H. Emery (c. 1983), Emeritus Professor of Human Genetics & Honorary Fellow, University of Edinburgh, who first established the *Elements of Medical Genetics* in 1968.

“The book was first conceived and published by the University of California Press in 1968 as *Heredity, Disease, and Man: Genetics in Medicine*. However, when appointed Professor of Human Genetics at Edinburgh in 1968 I decided I should prefer the book to be published by Churchill Livingstone under the title *Elements of Medical Genetics*, and made more accessible to UK students with a cheaper paperback edition. This was all achieved and has retained this format ever since. The current 15<sup>th</sup> edition illustrates very clearly how the subject has advanced so much over the intervening years.”

**Alan Emery**

## The History and Impact of Genetics in Medicine

Presenting historical truth is at least as challenging as the pursuit of scientific truth and our view of human endeavors down the ages is heavily biased in favor of winners—those who have conquered on military, political, or, indeed, scientific battlefields. The history of genetics in relation to medicine is one of breathtaking discovery from which patients and families have benefited hugely, but success will be measured by ongoing progress in translating discoveries into both treatment and prevention of disease, and we are privileged to be witnessing such developments at the beginning of what promises to be a dramatic and exciting era. But it is always inspiring to look back with awe at what our forebears achieved with scarce resources and sheer determination, sometimes aided by serendipity, in order to lay the foundations of this dynamic science. A holistic approach to science can be compared with driving a car: without your eyes on the road ahead, you will crash and make no progress; however, it is also essential to check the rear and side mirrors regularly.

### Gregor Mendel and the Laws of Inheritance

#### Early Beginnings

Developments in genetics during the 20th century have been truly spectacular. In 1900 Mendel's principles were awaiting rediscovery, chromosomes were barely visible, and the science of molecular genetics did not exist. As we write this in 2016, the published sequence of the entire human genome (2004) already feels like a piece of history, chromosomes can be rapidly analyzed to an extraordinary level of sophistication by microarray techniques, and next generation sequencing is transforming gene discovery and genetic testing in a clinical setting. The number of phenotypes with a known molecular basis is almost 5500 and the number of genes with a phenotype causing mutation is almost 3400.

Genetics is relevant and important to almost every medical discipline. Recent discoveries impinge not just on rare genetic diseases and syndromes but also on many of the common disorders of adult life that may be predisposed by genetic variation, such as cardiovascular disease, psychiatric illness, and cancer, not to mention influences on obesity, athletic performance, musical ability, longevity, and a host of physiological variations and tolerances. Clearly, a fundamental grounding in genetics should be part of any undergraduate medical curriculum.

We start with an overview of some of the most notable milestones in the history of genetics and medical genetics, followed by reviewing the overall impact of genetic factors in causing disease. Finally, we mention some new developments of major importance.

It is not known precisely when *Homo sapiens* first appeared on this planet, but current estimates, based on the finding of

*It's just a little trick, but there is a long story connected with it which it would take too long to tell.*

GREGOR MENDEL, IN CONVERSATION

WITH C.W. EICHLING

*It has not escaped our notice that the specific pairing we have postulated immediately suggests a possible copying mechanism for the genetic material.*

WATSON & CRICK (APRIL 1953)

fossilized human bones in Ethiopia, suggest man was roaming East Africa approximately 200,000 years ago. It is reasonable to suppose that our early ancestors were as curious as ourselves about matters of inheritance and, just as today, they would have experienced the birth of babies with all manner of physical defects. Engravings in Chaldea in Babylonia (modern-day Iraq) dating back at least 6000 years show pedigrees documenting the transmission of certain characteristics of the horse's mane. However, any early attempts to unravel the mysteries of genetics would have been severely hampered by a total lack of knowledge and understanding of basic processes such as conception and reproduction.

Early Greek philosophers and physicians such as Aristotle and Hippocrates concluded, not without a little prejudice, that important human characteristics were determined by semen, using menstrual blood as a culture medium and the uterus as an incubator. Semen was thought to be produced by the whole body; hence bald-headed fathers would beget bald-headed sons. These ideas prevailed until the 17th century, when Dutch scientists such as Leeuwenhoek and de Graaf recognized the existence of sperm and ova, thus explaining how the female could also transmit characteristics to her offspring.

The blossoming scientific revolution of the 18th and 19th centuries saw a revival of interest in heredity by scientists and physicians, among whom two names stand out. Pierre de Maupertuis, a French naturalist, studied hereditary traits such as extra digits (polydactyly) and lack of pigmentation (albinism), and showed from pedigree studies that these two conditions were inherited in different ways. Joseph Adams (1756–1818), a British doctor, also recognized that different mechanisms of inheritance existed and published *A Treatise on the Supposed Hereditary Properties of Diseases*, which was intended as a basis for genetic counseling. Also worthy of mention is the English physician Edward Meryon (1809–1880), who in 1851 was the first to provide a systematic clinicopathological study of three boys with the muscular disorder



FIGURE 1.1 Gregor Mendel. (Reproduced with permission from BMJ Books.)

later eponymously attributed to the Frenchman, Guillaume Duchenne (1806–1875), who described a larger series in 1868.

The modern scientific era really begins with the work of the Austrian monk Gregor Mendel (1822–1884; Figure 1.1) who, in 1865, presented the results of his breeding experiments on garden peas to the Natural History Society of Brünn in Bohemia (now Brno in the Czech Republic). Shortly after, Mendel's observations were published by that association in the Transactions of the Society, where they remained largely unnoticed until 1900, some 16 years after his death, when their importance was first recognized. In essence, Mendel's work can be considered as the discovery of genes and how they are inherited. The term **gene** was first coined in 1909 by a Danish botanist, Johannsen, and was derived from the term 'pangen', introduced by De Vries. This term was itself a derivative of the word 'pangenes', coined by Darwin in 1868. In recognition of Mendel's foundational work, the term **mendelian** is now part of scientific vocabulary, applied both to the different patterns of inheritance and to disorders found to be the result of defects in a single gene.

In his breeding experiments, Mendel studied contrasting characters in the garden pea, using for each experiment varieties that differed in only one characteristic. For example, he noted that when strains bred for a feature such as tallness were crossed with plants bred to be short all of the offspring in the first filial or F1 generation were tall. If plants in this F1 generation were interbred, this led to both tall and short plants in a ratio of 3 : 1 (Figure 1.2). Characteristics that were manifest in the F1 hybrids were referred to as **dominant**, whereas those that reappeared in the F2 generation were described as being **recessive**. On reanalysis it has been suggested that Mendel's results were 'too good to be true' in that the segregation ratios he derived were suspiciously closer to the value of 3 : 1 than the laws of statistics would predict. One possible explanation is that he may have published only those results that best agreed with his preconceived single-gene hypothesis. Whatever the case, events have shown that Mendel's interpretation of his results was entirely correct.

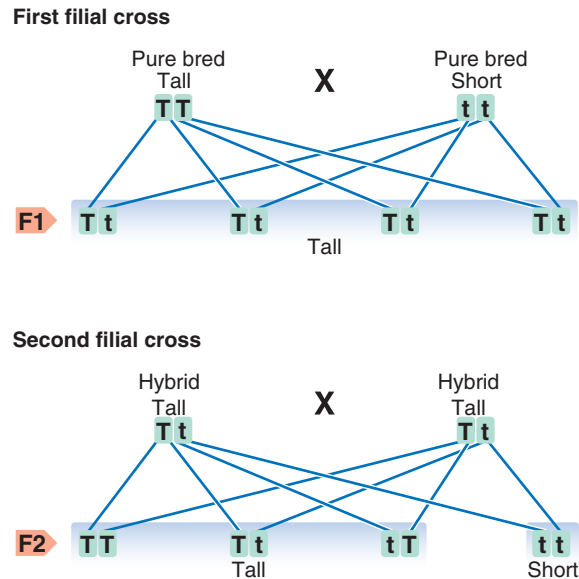


FIGURE 1.2 An illustration of one of Mendel's breeding experiments and how he correctly interpreted the results.

Mendel's proposal was that the plant characteristics being studied were each controlled by a pair of factors, one of which was inherited from each parent. The pure-bred plants, with two identical genes, used in the initial cross would now be referred to as **homozygous**. The hybrid F1 plants, each of which has one gene for tallness and one for shortness, would be referred to as **heterozygous**. The genes responsible for these contrasting characteristics are referred to as **allelomorphs**, or **alleles** for short.

An alternative method for determining **genotypes** in offspring involves the construction of what is known as a Punnett square (Figure 1.3). This is used further in Chapter 7 when considering how genes segregate in large populations.

On the basis of Mendel's plant experiments, three main principles were established. These are known as the laws of uniformity, segregation, and independent assortment.

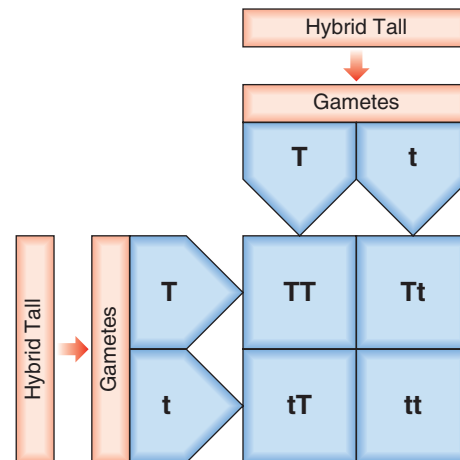


FIGURE 1.3 A Punnett square showing the different ways in which genes can segregate and combine in the second filial cross from Figure 1.2. Construction of a Punnett square provides a simple method for showing the possible gamete combinations in different matings.

### The Law of Uniformity

The *law of uniformity* refers to the fact that when two homozygotes with different alleles are crossed, all of the offspring in the F1 generation are identical and heterozygous. In other words, the characteristics do not blend, as had been believed previously, and can reappear in later generations.

### The Law of Segregation

The *law of segregation* refers to the observation that each person possesses two genes for a particular characteristic, only one of which can be transmitted at any one time. Rare exceptions to this rule can occur when two allelic genes fail to separate because of chromosome nondisjunction at the first meiotic division (p. 30).

### The Law of Independent Assortment

The *law of independent assortment* refers to the fact that members of different gene pairs segregate to offspring independently of one another. In reality, this is not always true, as genes that are close together on the same chromosome tend to be inherited together, because they are 'linked' (p. 89). There are a number of other ways by which the laws of mendelian inheritance are breached but, overall, they remain foundational to our understanding of the science.

### The Chromosomal Basis of Inheritance

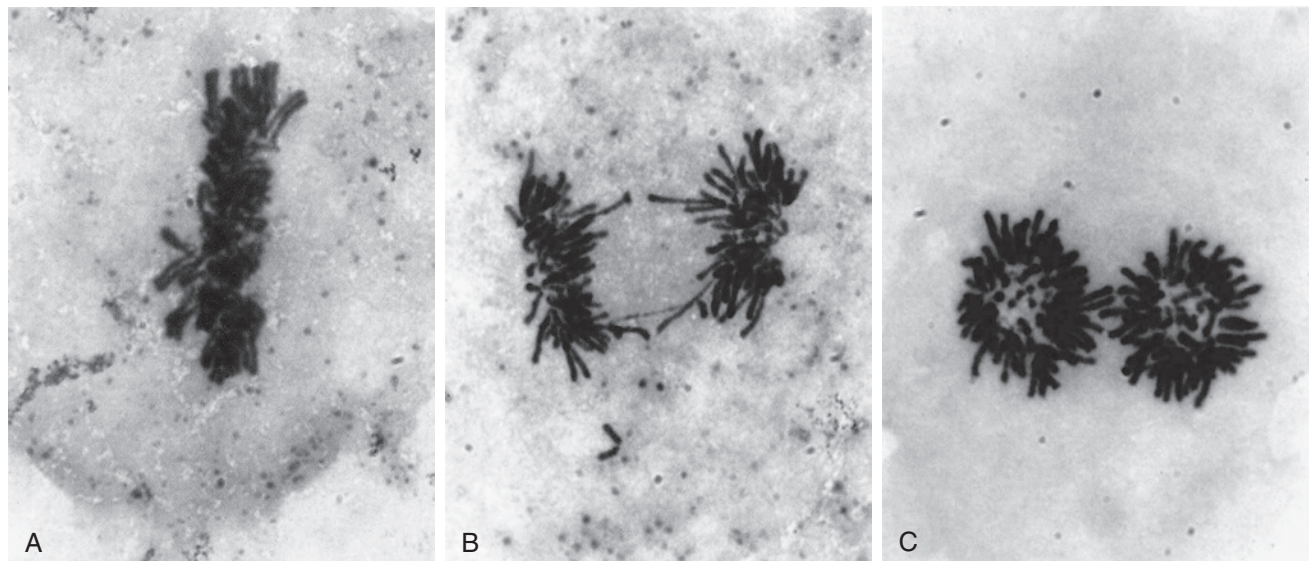
As interest in mendelian inheritance grew, there was much speculation as to how it actually occurred. At that time it was also known that each cell contains a nucleus within which there are several threadlike structures known as **chromosomes**, so called because of their affinity for certain stains (*chroma* = color, *soma* = body). These chromosomes had been observed since the second half of the 19th century after development of cytologic staining techniques. Human mitotic figures were observed from the late 1880s, and it was in 1902 that Walter Sutton, an American medical student, and Theodor Boveri, a German biologist, independently proposed that chromosomes could be the bearers of heredity (Figure 1.4). Subsequently,

Thomas Morgan transformed Sutton's chromosome theory into the theory of the gene, and Alfons Janssens observed the formation of chiasmata between homologous chromosomes at meiosis. During the late 1920s and 1930s, Cyril Darlington helped to clarify chromosome mechanics by the use of tulips collected on expeditions to Persia. It was during the 1920s that the term **genome** entered the scientific vocabulary, being the fusion of *genom* (German for 'gene') and *ome* from 'chromosome'.

When the connection between mendelian inheritance and chromosomes was first made, it was thought that the normal chromosome number in humans might be 48, although various papers had come up with a range of figures. Key to the number 48 was a paper in 1921 from Theophilus Painter, an American cytologist who had been a student of Boveri. In fact, Painter had some preparations clearly showing 46 chromosomes, even though he finally settled on 48. These discrepancies were probably from the poor quality of the material at that time; even into the early 1950s, cytologists were counting 48 chromosomes. It was not until 1956 that the correct number of 46 was established by Tjio and Levan, 3 years after the correct structure of DNA had been proposed. Within a few years, it was shown that some disorders in humans could be caused by loss or gain of a whole chromosome as well as by an abnormality in a single gene. Chromosome disorders are discussed at length in Chapter 17. Some chromosome aberrations, such as translocations, can run in families (p. 35), and are sometimes said to be segregating in a mendelian fashion.

### DNA as the Basis of Inheritance

Whilst James Watson and Francis Crick are justifiably credited with discovering the structure of DNA in 1953, they were attracted to working on it only because of its key role as the genetic material, as established in the 1940s. Formerly many believed that hereditary characteristics were transmitted by proteins, until it was appreciated that their molecular structure was far too cumbersome. Nucleic acids were actually discovered in 1849. In 1928 Fred Griffith, working on two strains of



**FIGURE 1.4** Chromosomes dividing into two daughter cells at different stages of cell division. **A**, Metaphase; **B**, anaphase; **C**, telophase. The behavior of chromosomes in cell division (mitosis) is described at length in Chapter 3. (Photographs courtesy Dr. K. Ocraft, City Hospital, Nottingham.)

*Streptococcus*, realized that characteristics of one strain could be conferred on the other by something that he called the **transforming principle**. In 1944, at the Rockefeller Institute in New York, Oswald Avery, Maclyn McCarty, and Colin MacLeod identified DNA as the genetic material while working on *Streptococcus pneumoniae*. Even then, many in the scientific community were sceptical; DNA was only a simple molecule with lots of repetition of four nucleic acids—very boring! The genius of Watson and Crick, at Cambridge, was to hit on a structure for DNA, the elegant double helix, that would explain the very essence of biological reproduction. Crucial to their discovery were the x-ray crystallography images captured by the often-overlooked graduate technician Raymond Gosling, working under the supervision of Maurice Wilkins and Rosalind Franklin in John Randall's laboratory at King's College, London.

This was merely the beginning, for it was necessary to discover the process whereby DNA, in discrete units called genes, issues instructions for the precise assembly of proteins, the building blocks of tissues. The sequence of bases in DNA, and the sequence of amino acids in protein, the **genetic code**, was unravelled in some elegant biochemical experiments in the 1960s and it became possible to predict the base change in DNA that led to the amino-acid change in the protein. Further experiments, involving Francis Crick, Paul Zamecnik, and Mahlon Hoagland, identified the molecule transfer RNA (tRNA) (p. 15), which directs genetic instructions via amino acids to intracellular ribosomes, where protein chains are produced. Confirmation of these discoveries came with DNA sequencing methods and the advent of recombinant DNA techniques. Interestingly, however, the first genetic trait to be characterized at the molecular level had already been identified in 1957 by laborious sequencing of the purified proteins. This was sickle-cell anemia, in which the mutation affects the amino-acid sequence of the blood protein hemoglobin.

## The Fruit Fly

Before returning to historical developments in human genetics, it is worth a brief diversion to consider the merits of an unlikely creature that has proved to be of great value in genetic research. The fruit fly, *Drosophila*, possesses several distinct advantages for the study of genetics:

1. It can be bred easily in a laboratory.
2. It reproduces rapidly and prolifically at a rate of 20 to 25 generations per annum.
3. It has a number of easily recognized characteristics, such as *curly wings* and a *yellow body*, which follow mendelian inheritance.
4. *Drosophila melanogaster*, the species studied most frequently, has only four pairs of chromosomes, each of which has a distinct appearance so that they can be identified easily.
5. The chromosomes in the salivary glands of *Drosophila* larvae are among the largest known in nature, being at least 100 times bigger than those in other body cells.

In view of these unique properties, fruit flies were used extensively in early breeding experiments, contributing enormously to developmental biology, where knowledge of gene homology throughout the animal kingdom has enabled scientists to identify families of genes that are important in human embryogenesis (see Chapter 9). The sequencing of the 180 million base pairs of the *Drosophila melanogaster* genome was completed in late 1999.

## The Origins of Medical Genetics

In addition to the previously mentioned Pierre de Maupertuis and Joseph Adams, whose curiosity was aroused by polydactyly and albinism, there were other pioneers. John Dalton, of atomic theory fame, observed that some conditions, notably color blindness and hemophilia, show what is now referred to as sex- or X-linked inheritance; color blindness is still occasionally referred to as **daltonism**.

In 1900 Mendel's work resurfaced. His papers were quoted almost simultaneously by three European botanists—De Vries (Holland), Correns (Germany), and Von Tschermak (Austria)—and this marked the real beginning of medical genetics, providing an enormous impetus for the study of inherited disease. Credit for the first recognition of a single-gene trait is shared by William Bateson and Archibald Garrod, who together proposed that alkaptonuria was a rare recessive disorder. In this relatively benign condition, urine turns dark on standing or on exposure to alkali because of the patient's inability to metabolize homogentisic acid (p. 258). Young children show skin discoloration in the napkin (diaper) area and affected adults may develop arthritis in large joints. Realizing that this was an inherited disorder involving a chemical process, Garrod coined the term **inborn error of metabolism** in 1908, though his work was largely ignored until the mid-20th century when electrophoresis and chromatography revolutionized biochemistry. Several hundred such disorders have now been identified, giving rise to the field of **biochemical genetics** (see Chapter 18).

During the course of the 20th century, it gradually became clear that hereditary factors were implicated in many conditions and that different genetic mechanisms were involved. Traditionally, hereditary conditions have been considered under the headings of **single gene**, **chromosomal**, and **multifactorial**. Increasingly, it is becoming clear that the interplay of different genes (**polygenic inheritance**) is important in disease, and that a further category—**acquired somatic genetic disease**—should also be included.

## Single-Gene Disorders

In addition to alkaptonuria, Garrod suggested that albinism and cystinuria could also be recessive. Soon other examples followed, leading to an explosion in knowledge and disease delineation. By 1966 almost 1500 single-gene disorders or traits had been identified, prompting the publication by an American physician, Victor McKusick (Figure 1.5), of a catalog of all known single-gene conditions. By 1998, when the 12th edition of the catalog was published, it contained more than 8500 entries. The growth of 'McKusick's Catalog' was exponential and became the electronic *Online Mendelian Inheritance in Man* (OMIM) (see Appendix) in 1987. By August 2016, OMIM contained more than 23,600 entries.

## Chromosome Abnormalities

Improved techniques for studying chromosomes led to the demonstration in 1959 that the presence of an additional number 21 chromosome (*trisomy 21*) results in Down syndrome. Other similar discoveries followed rapidly—Klinefelter and Turner syndromes—also in 1959. The identification of chromosome abnormalities was further aided by the development of banding techniques in 1970 (p. 26). These enabled reliable identification of individual chromosomes and helped confirm that loss or gain of even a very small segment of a



**FIGURE 1.5** Victor McKusick in 1994, whose studies and catalogs have been so important to medical genetics.

chromosome can have devastating effects on human development (see [Chapter 17](#)).

Later it was shown that several rare conditions featuring learning difficulties and abnormal physical features are due to loss of such a tiny amount of chromosome material that no abnormality can be detected using even the most high-powered light microscope. These conditions are referred to as microdeletion syndromes ([p. 245](#)) and can be diagnosed using a technique known as **FISH (fluorescent *in situ* hybridization)**, which combines conventional chromosome analysis (**cytogenetics**) with newer DNA diagnostic technology (**molecular genetics**) (see [Chapter 5](#)). Today, the technique of microarray **CGH (comparative genomic hybridization)** has revolutionized clinical investigation through the detection of subtle genomic imbalances ([p. 54](#)) and, where it is available, become the first-line test of choice.

### Multifactorial Disorders

Francis Galton, a cousin of Charles Darwin, had a long-standing interest in human characteristics such as stature, physique, and intelligence. Much of his research was based on the study of identical twins, in whom it was realized that differences in these parameters must be largely the result of environmental influences. Galton introduced to genetics the concept of the **regression coefficient** as a means of estimating the degree of resemblance between various relatives. This concept was later extended to incorporate Mendel's discovery of genes, to try to explain how parameters such as height and skin color could be determined by the interaction of many genes, each exerting a small additive effect. This is in contrast to single-gene characteristics in which the action of one gene is exerted independently, in a nonadditive fashion.

This model of **quantitative inheritance** is now widely accepted and has been adapted to explain the pattern of inheritance observed for many relatively common conditions (see [Chapter 10](#)). These include congenital malformations such as cleft lip and palate, and late-onset conditions such as hypertension, diabetes mellitus, and Alzheimer disease. The

prevailing view is that genes at several loci interact to generate a susceptibility to the effects of adverse environmental trigger factors. Recent research has confirmed that many genes are involved in most of these adult-onset disorders, although progress in identifying specific susceptibility loci has been disappointingly slow. It has also emerged that in some conditions, such as type I diabetes mellitus, different genes can exert major or minor effects in determining susceptibility ([p. 130](#)). Overall, **multifactorial** or **polygenic** conditions are now known to make a major contribution to chronic illness in adult life (see [Chapter 10](#)).

### Acquired Somatic Genetic Disease

Not all genetic errors are present from conception. Many billions of cell divisions (**mitoses**) occur in the course of an average human lifetime. During each mitosis, there is an opportunity for both single-gene mutations to occur, because of DNA copy errors, and for numerical chromosome abnormalities to arise as a result of errors in chromosome separation. Accumulating somatic mutations and chromosome abnormalities are now known to play a major role in causing cancer (see [Chapter 14](#)), and they probably also explain the rising incidence with age of many other serious illnesses, as well as the aging process itself. It is therefore necessary to appreciate that not all disease with a genetic basis is hereditary.

Before considering the impact of hereditary disease, it is helpful to introduce a few definitions.

#### Incidence

Incidence refers to the rate at which new cases occur. Thus, if the birth incidence of a particular condition equals 1 in 1000, then on average 1 in every 1000 newborn infants is affected.

#### Prevalence

This refers to the proportion of a population affected at any one time. The prevalence of a genetic disease is usually less than its birth incidence, either because life expectancy is reduced or because the condition shows a delayed age of onset.

#### Frequency

Frequency is a general term that lacks scientific specificity, although the word is often taken as being synonymous with incidence when calculating gene 'frequencies' (see [Chapter 7](#)).

#### Congenital

**Congenital** means that a condition is present at birth. Thus, cleft palate represents an example of a congenital **malformation**. Not all genetic disorders are congenital in terms of age of onset (e.g., Huntington disease), nor are all congenital abnormalities genetic in origin (e.g., fetal disruptions, as discussed in [Chapter 16](#)).

### DNA Sequencing

The ability to search for mutations in human DNA to identify the causes of genetic disease clearly depended on being able to sequence DNA, which initially was very laborious. The first really practical method was developed by Walter Gilbert, with sequencing based on a cleavage at specific bases after chemical modification of DNA. But it was Frederick Sanger's ([Figure 1.6](#)) ingenious technique (1975), based on dideoxynucleotide chain termination, that proved efficient, reliable and popular, not least because of low radioactivity. These techniques formed the basis for embarking on the Human Genome Project, though



**FIGURE 1.6** Frederick Sanger, who invented the most widely used method of DNA sequencing, and won two Nobel Prizes.

the first genome to be sequenced was that of a bacteriophage in 1977. Both men were awarded the Nobel Prize in 1980 for this achievement, which was Sanger's second—he was awarded the Chemistry Prize in 1958 for determining the amino acid sequence of insulin (he remains the only British scientist to have won two Nobel Prizes). 'Sanger sequencing' remains vital to human molecular genetics, and the term is as prominent in the language of genetics as 'mendelian inheritance' and 'McKusick's Catalog'.

### The Impact of Genetic Disease

During the 20th century, improvements in all areas of medicine, most notably public health and therapeutics, resulted in changing patterns of disease, with increasing recognition of the role of genetic factors at all ages. For some parameters, such as perinatal mortality, the actual numbers of cases with exclusively genetic causes have probably remained constant but their **relative** contribution to overall figures has increased as other causes, such as infection, have declined. For other conditions, such as the chronic diseases of adult life, the overall contribution of genetics has almost certainly increased as greater life expectancy has provided more opportunity for adverse genetic and environmental interaction to manifest itself, for example in Alzheimer disease, macular degeneration, cardiomyopathy, and diabetes mellitus. Today there is much debate about the relative contributions of genetic and environmental factors in the increasing prevalence of obesity in the developed world.

Consider the impact of genetic factors in disease at different ages from the following observations.

#### Spontaneous Miscarriages

A chromosome abnormality is present in 40% to 50% of all recognized first-trimester pregnancy loss. Approximately 1 in 4 of all pregnancies results in spontaneous miscarriage, so at

least 10% of all recognized conceptions are chromosomally abnormal (p. 236). This value would be much higher if unrecognized pregnancies could also be included, and it is likely that a significant proportion of miscarriages with normal chromosomes do in fact have catastrophic submicroscopic genetic errors.

#### Newborn Infants

Up to 3% of neonates have at least one major congenital abnormality, of which at least 50% are caused exclusively or partially by genetic factors (see Chapter 16), with the incidences of chromosome abnormalities and single-gene disorders in neonates being roughly 1 in 200 and 1 in 100, respectively.

#### Childhood

By school age roughly 12-14% of children show problems of developmental origin. Genetic disorders account for at least 50% of all childhood blindness, at least 50% of all childhood deafness, and at least 50% of all cases of severe learning difficulty. In developed countries, genetic disorders and congenital malformations together also account for 30% of all childhood hospital admissions and 40% to 50% of all childhood deaths.

#### Adult Life

Approximately 1% of all malignancies are primarily caused by single-gene inheritance, and between 5% and 10% of common cancers such as those of the breast, colon, and ovary have a strong hereditary component. By the age of 25 years, 5% of the population will have a disorder in which genetic factors play an important role. Taking into account the genetic contribution to cancer and cardiovascular diseases, such as coronary artery occlusion and hypertension, it has been estimated that more than 50% of the older adult population in developed countries will have a genetically determined medical problem.

### Major New Developments

The study of genetics and its role in causing human disease is now widely acknowledged as being among the most exciting and influential areas of medical research. Since 1962 when Francis Crick, James Watson, and Maurice Wilkins gained acclaim for their elucidation of the structure of DNA, the Nobel Prize for Medicine and/or Physiology has been won on 24 occasions, and the Chemistry Prize on six occasions, by scientists working in human and molecular genetics or related fields (Table 1.1). These pioneering studies have spawned a thriving molecular technology industry with applications as diverse as the development of genetically modified disease-resistant crops, the use of genetically engineered animals to produce therapeutic drugs, and the possible introduction of DNA-based vaccines for conditions such as malaria, not to mention the growing availability of affordable direct-to-consumer testing for disease susceptibility. Pharmaceutical companies are investing heavily in the DNA-based **pharmacogenomics**—drug therapy tailored to personal genetic makeup.

#### The Human Genome Project (HGP)

In 1988 a group of visionary scientists in the United States persuaded Congress to fund a coordinated international program to sequence the entire human genome. The program would run from 1990 to 2005 and US\$3 billion were initially allocated to the project. Some 5% of the budget was allocated to study the ethical and social implications of the new



**Table 1.1** Genetic Discoveries That Have Led to the Award of the Nobel Prize for Medicine or Physiology and/or Chemistry, 1962–2012

Year	Prize Winners	Discovery	Year	Prize Winners	Discovery
1962	Francis Crick James Watson Maurice Wilkins	The molecular structure of DNA	1995	Edward Lewis Christiane Nüsslein-Volhard Eric Wieschaus	Homeotic and other developmental genes
1965	François Jacob Jacques Monod André Lwoff	Genetic regulation	1997	Stanley Prusiner	Prions
1966	Peyton Rous	Oncogenic viruses	1999	Günter Blobel	Protein transport signaling
1968	Robert Holley Gobind Khorana Marshall Nireberg	Deciphering of the genetic code	2000	Arvid Carlsson Paul Greengard Eric Kandel	Signal transduction in the nervous system
1972	Christian B. Anfisen Stanford Moore William H. Stein	Ribonuclease	2001	Leland Hartwell Timothy Hunt Paul Nurse	Regulators of the cell cycle
1975	David Baltimore Renato Dulbecco Howard Temin	Interaction between tumor viruses and nuclear DNA	2002	Sydney Brenner Robert Horritz John Sulston	Genetic regulation in development and programmed cell death (apoptosis)
1978	Werner Arber Daniel Nathans Hamilton Smith	Restriction endonucleases	2006	Andrew Fire Craig Mello Roger D. Kornberg	RNA interference (Medicine) Eukaryotic transcription (Chemistry)
1980	Baruj Benacerraf Jean Dausset George Snell Paul Berg Walter Gilbert Frederick Sanger	Genetic control of immunologic responses (Medicine) Biochemistry of nucleic acids (Chemistry)	2007	Mario Capecchi Martin Evans Oliver Smithies	Gene modification by the use of embryonic stem cells
1983	Barbara McClintock	Mobile genes (transposons)	2009	Elizabeth Blackburn Carol Greider Jack Szostak	The role of telomerase in protecting chromosome telomeres (Medicine)
1985	Michael Brown Joseph Goldstein	Cell receptors in familial hypercholesterolemia		Venkatraman Ramakrishnan Thomas A. Steitz Ada E. Yonath	Structure and function of the ribosome (Chemistry)
1987	Susumu Tonegawa	Genetic aspects of antibodies	2010	Robert G. Edwards	In vitro fertilization
1989	Michael Bishop Harold Varmus Sidney Altman Thomas R. Cech	Study of oncogenes (Medicine) Catalytic properties of RNA (Chemistry)	2012	John B. Gurdon Shinya Yamanaka	Mature cells reprogrammed to become pluripotent cells (Medicine)
1993	Richard Roberts Phillip Sharp Kary B. Mullis Michael Smith	'Split genes' (Medicine) DNA-based chemistry, including the invention of PCR (Chemistry)		Robert J. Lefkowitz Brian K. Kobilka	G-protein coupled receptors (Chemistry)

knowledge in recognition of the enormous potential to influence public health policies, screening programs, and personal choice. The project was likened to the Apollo moon mission in terms of its complexity, although in practical terms the long-term benefits are likely to be much more tangible. The draft DNA sequence of 3 billion base pairs was completed successfully in 2000 and the complete sequence published ahead of schedule in October 2004. Before the closing stages of the project, it was thought that there might be approximately 100,000 coding genes that provide the blueprint for human life. It has come as a surprise to many that the number is much lower, and has been continually revised downwards with current estimates at around 20,000. However, we have learned that many genes have the capacity to perform multiple functions, thus challenging traditional concepts of disease classification. The HGP has now been succeeded by the **Human Variome Project**, aimed at compiling and sharing the enormous variation in human DNA sequence worldwide, all of which is potentially possible since **whole exome sequencing** (WES) and **whole genome sequencing** (WGS) are taking place on an

industrial scale in numerous population studies and, for the direct benefit of patients, projects such as Deciphering Developmental Disorders (DDD) based at the Sanger Centre, Cambridge, and 100,000 Genomes in the UK, and their equivalent elsewhere. Indeed, WES in particular has facilitated a huge surge in disease gene discovery since the last published edition of this book. This has led to the exciting growth area of **Bioinformatics**, the science where biology, computer science, and information technology merge into a single discipline that encompasses gene maps, DNA sequences, comparative and functional genomics, and a lot more. Familiarity with interlinking databases is essential for the molecular geneticist, and increasingly so for keen clinicians with an interest in genetics, who will find OMIM a good place to start.

### The Prospects for Treatment

Most genetic disease is resistant to conventional treatment so that the prospect of successfully modifying the genetic code in a patient's cells is extremely attractive. Despite major investment and extensive research, success in humans has so far been

limited to a few very rare immunologic disorders. For more common conditions, such as cystic fibrosis, major problems have been encountered, such as targeting the correct cell populations, overcoming the body's natural defense barriers, and identifying suitably nonimmunogenic vectors. However, the availability of mouse models for genetic disorders, such as cystic fibrosis (p. 286), Huntington disease (p. 273), and Duchenne muscular dystrophy (p. 281), has greatly enhanced research opportunities, particularly in unraveling the cell biology of these conditions. In recent years there has been increasing optimism for novel drug therapies and stem cell treatment (p. 210), besides the prospects for gene therapy itself (p. 207).

## The Societal Impact of Advances in Genetics

Each new advance in genetic technology has generated fresh ethical concerns about how the science will be applied and utilized in medicine, at the center of which is the recognition that a person's genetic make-up is fundamental to both their identity and possible disease susceptibility. These issues are explored in detail in Chapter 22. The most contentious field is prenatal genetics and reproductive choice, though national legal frameworks and cultural practices vary widely worldwide. The controversy surrounding the early ability to perform prenatal karyotyping for Down syndrome in the mid-1960s is mirrored today in the technology that will make it possible to perform detailed genetic screening of the unborn baby on cell-free fetal DNA in the maternal circulation, or on embryos created through *in vitro* fertilization. Great debate has taken place, and will continue, concerning the disclosure of unexpected but significant 'incidental findings' from WES or WGS carried out for specific clinical purposes, and the possibility of all newborns having their genome sequenced and screened is both technically feasible and has been seriously mooted at governmental level. Many of the questions raised do not have easy or straightforward answers, which means that there will be a great need for appropriately trained clinicians and counselors to meet the public demands for the foreseeable future.

### FURTHER READING

- Baird, P.A., Anderson, T.W., Newcombe, H.B., Lowry, R.B., 1988. Genetic disorders in children and young adults: a population study. *Am. J. Hum. Genet.* 42, 677–693.  
*A comprehensive study of the incidence of genetic disease in a large Western urban population.*  
*The first report of the complete sequencing of a human chromosome.*
- Emery, A.E.H., 1989. Portraits in medical genetics—Joseph Adams 1756–1818. *J. Med. Genet.* 26, 116–118.  
*An account of the life of a London doctor who made remarkable observations about hereditary disease in his patients.*
- Emery, A.E.H., Emery, M.L.H., 2011. The history of a genetic disease: Duchenne muscular dystrophy or Meryon's disease, second ed. Oxford University Press, Oxford, UK.  
*Describes the life and work of Edward Meryon, the first physician to describe Duchenne muscular dystrophy in detail.*

Garrod, A.E., 1902. The incidence of alkaptonuria: a study in chemical individuality. *Lancet* ii, 1916–1920.

*A landmark paper in which Garrod proposed that alkaptonuria could show mendelian inheritance and also noted that 'the mating of first cousins gives exactly the conditions most likely to enable a rare, and usually recessive, character to show itself'.*

Orel, V., 1995. Gregor Mendel: the first geneticist. Oxford University Press, Oxford.

*A detailed biography of the life and work of the Moravian monk who was described by his abbot as being 'very diligent in the study of the sciences but much less fitted for work as a parish priest'.*

Sanger, F., Coulson, A.R., 1975. A rapid method for determining sequences in DNA by primed synthesis with DNA polymerase. *J. Mol. Biol.* 94, 441–448.

Watson, J., 1968. The double helix. Atheneum, New York.

*The story of the discovery of the structure of DNA, through the eyes of Watson himself.*

### Databases

Online Mendelian Inheritance in Man:

<http://www.ncbi.nlm.nih.gov/omim>

For Literature:

<http://www.ncbi.nlm.nih.gov/PubMed/>

<http://scholar.google.com/>

Genome:

<http://www.ncbi.nlm.nih.gov/omim/GenBank>

<http://www.hgmd.cf.ac.uk> (human, Cardiff)

<http://www.ensembl.org> (human, comparative, European, Cambridge)

<http://genome.ucsc.edu> (American browser)

<http://www.humanvariomeproject.org/>

### ELEMENTS

- 1 A characteristic manifest in a hybrid (heterozygote) is dominant. A recessive characteristic is expressed only in an individual with two copies of the mutated gene (i.e., a homozygote).
- 2 Mendel proposed that each individual has two genes for each characteristic: one is inherited from each parent and one is transmitted to each child. Genes at different loci act and segregate independently.
- 3 Chromosome separation at cell division facilitates gene segregation.
- 4 Genetic disorders are present in at least 2% of all neonates, accounting for at least 50% of childhood blindness, deafness, learning difficulties and deaths.
- 5 From the rediscovery of Mendel's genetic research on peas, to the full sequencing of the human genome, almost exactly 100 years elapsed.
- 6 Molecular genetics and cell biology are at the forefront of medical research, combined with the discipline of bioinformatics, and hold the promise of novel forms of treatment for genetic diseases.

## SECTION A

### The Scientific Basis of Human Genetics

## Chapter 2

# The Cellular and Molecular Basis of Inheritance

The hereditary material is present in the nucleus of the cell, whereas protein synthesis takes place in the cytoplasm. What is the chain of events that leads from the gene to the final product?

This chapter covers basic cellular biology outlining the structure of DNA, the process of DNA replication, the types of DNA sequences, gene structure, the genetic code, the processes of transcription and translation, the various types of mutations, mutagenic agents, and DNA repair.

### The Cell

Within each cell of the body, visible with the light microscope, is the **cytoplasm** and a darkly staining body, the **nucleus**, the latter containing the hereditary material in the form of **chromosomes** (Figure 2.1). The phospholipid bilayer of the plasma membrane protects the interior of the cell but remains selectively permeable and has integral proteins involved in recognition and signaling between cells. The nucleus has a darkly staining area, the **nucleolus**. The nucleus is surrounded by a membrane, the **nuclear envelope**, which separates it from the cytoplasm but still allows communication through **nuclear pores**.

The cytoplasm contains the **cytosol**, which is semifluid in consistency, containing both soluble elements and cytoskeletal structural elements. In addition, in the cytoplasm there is a

*There is nothing, Sir, too little for so little a creature as man.*

*It is by studying little things that we attain the great art of having as little misery and as much happiness as possible.*

SAMUEL JOHNSON

complex arrangement of very fine, highly convoluted, interconnecting channels, the endoplasmic reticulum. The **endoplasmic reticulum**, in association with the **ribosomes**, is involved in the biosynthesis of proteins and lipids. Also situated within the cytoplasm are other even more minute cellular organelles that can be visualized only with an electron microscope. These include the Golgi apparatus, which is responsible for the secretion of cellular products, the **mitochondria**, which are involved in energy production through the oxidative phosphorylation metabolic pathways, and the **peroxisomes** (p. 268) and **lysosomes**, both of which are involved in the degradation and disposal of cellular waste material and toxic molecules.

### DNA: The Hereditary Material

#### Composition

Nucleic acid is composed of a long polymer of individual molecules called **nucleotides**. Each nucleotide is composed of a nitrogenous base, a sugar molecule, and a phosphate molecule. The nitrogenous bases fall into two types, **purines** and **pyrimidines**. The purines include adenine and guanine; the pyrimidines include cytosine, thymine, and uracil.

There are two different types of nucleic acid, **ribonucleic acid (RNA)**, which contains the five-carbon sugar ribose, and **deoxyribonucleic acid (DNA)**, in which the hydroxyl group at the 2 position of the ribose sugar is replaced by a hydrogen (i.e., an oxygen molecule is lost, hence 'deoxy'). DNA and RNA both contain the purine bases adenine and guanine and the pyrimidine cytosine, but thymine occurs only in DNA and uracil is found only in RNA.

RNA is present in the cytoplasm and in particularly high concentrations in the nucleolus of the nucleus. DNA, on the other hand, is found mainly in the chromosomes.

#### Structure

For genes to be composed of DNA, it is necessary that the latter should have a structure sufficiently versatile to account for the great variety of different genes and yet, at the same time, be

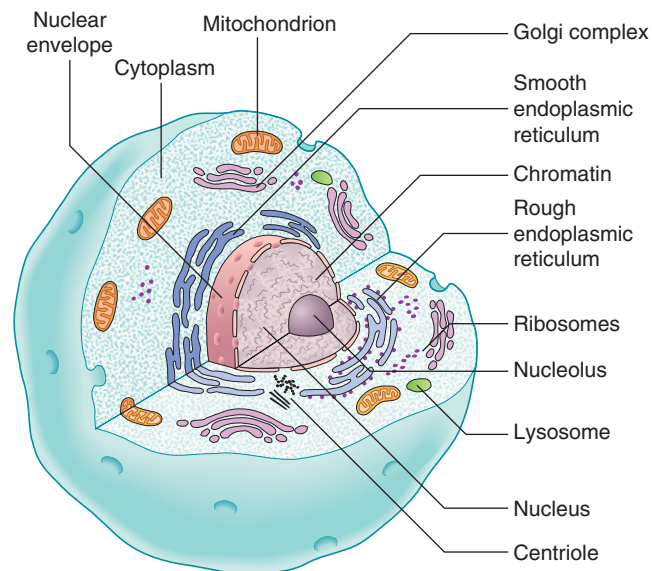


FIGURE 2.1 Diagrammatic representation of an animal cell.

able to reproduce itself in such a manner that an identical replica is formed at each cell division. In 1953, Watson and Crick, based on x-ray diffraction studies by themselves and others, proposed a structure for the DNA molecule that fulfilled all the essential requirements. They suggested that the DNA molecule is composed of two chains of nucleotides arranged in a double helix. The backbone of each chain is formed by phosphodiester bonds between the 3' and 5' carbons of adjacent sugars, the two chains being held together by hydrogen bonds between the nitrogenous bases, which point in toward the center of the helix. Each DNA chain has a polarity determined by the orientation of the sugar–phosphate backbone. The asymmetric ends of the DNA chains are called the 5' and 3' ends, with the 5' end having a terminal phosphate group and the 3' end a terminal hydroxyl group. In the DNA duplex, the 5' end of one strand is opposite the 3' end of the other, that is, they have opposite orientations and are said to be **antiparallel**.

The arrangement of the bases in the DNA molecule is not random. A purine in one chain always pairs with a pyrimidine in the other chain, with specific pairing of the base pairs: guanine in one chain always pairs with cytosine in the other chain, and adenine always pairs with thymine, so that this base pairing forms complementary strands (Figure 2.2). For their work Watson and Crick, along with Maurice Wilkins, were awarded the Nobel Prize for Medicine or Physiology in 1962 (p. 7).

## Replication

The process of **DNA replication** provides an answer to the question of how genetic information is transmitted from one generation to the next. During nuclear division the two strands of the DNA double helix separate through the action of enzyme

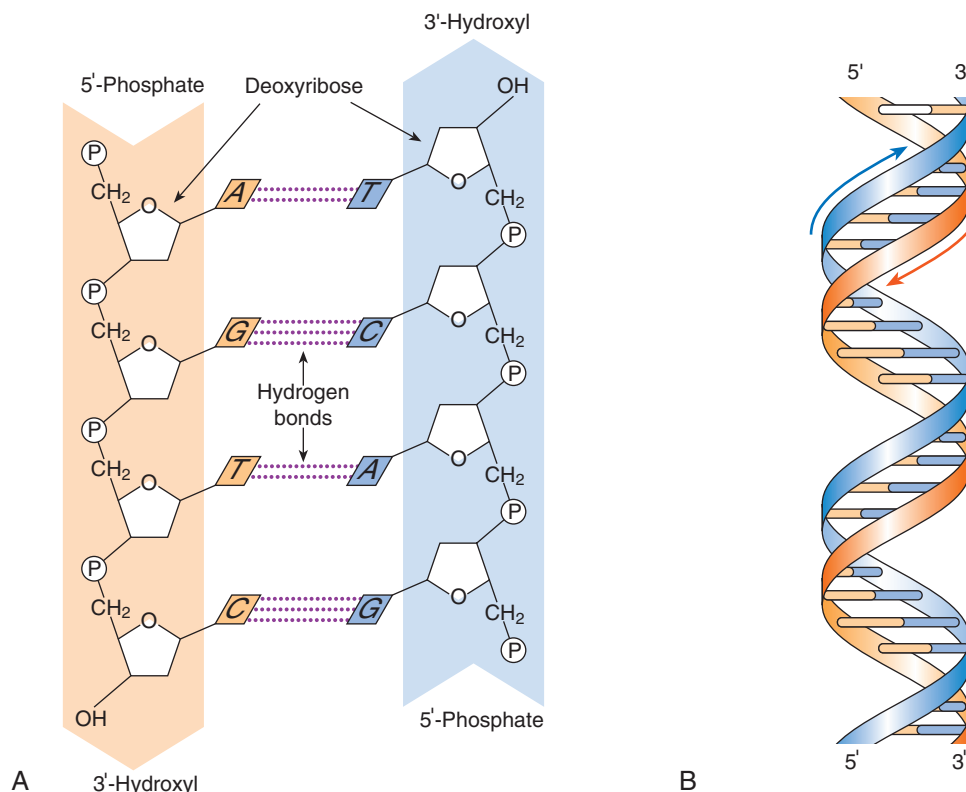
DNA helicase, each DNA strand directing the synthesis of a complementary DNA strand through specific base pairing, resulting in two daughter DNA duplexes that are identical to the original parent molecule. In this way, when cells divide, the genetic information is conserved and transmitted unchanged to each daughter cell. The process of DNA replication is termed **semiconservative**, because only one strand of each resultant daughter molecule is newly synthesized.

DNA replication, through the action of the enzyme DNA polymerase, takes place at multiple points known as **origins of replication**, forming bifurcated Y-shaped structures known as **replication forks**. The synthesis of both complementary antiparallel DNA strands occurs in the 5' to 3' direction. One strand, known as the **leading strand**, is synthesized as a continuous process. The other strand, known as the **lagging strand**, is synthesized in pieces called Okazaki fragments, which are then joined together as a continuous strand by the enzyme DNA ligase (Figure 2.3A).

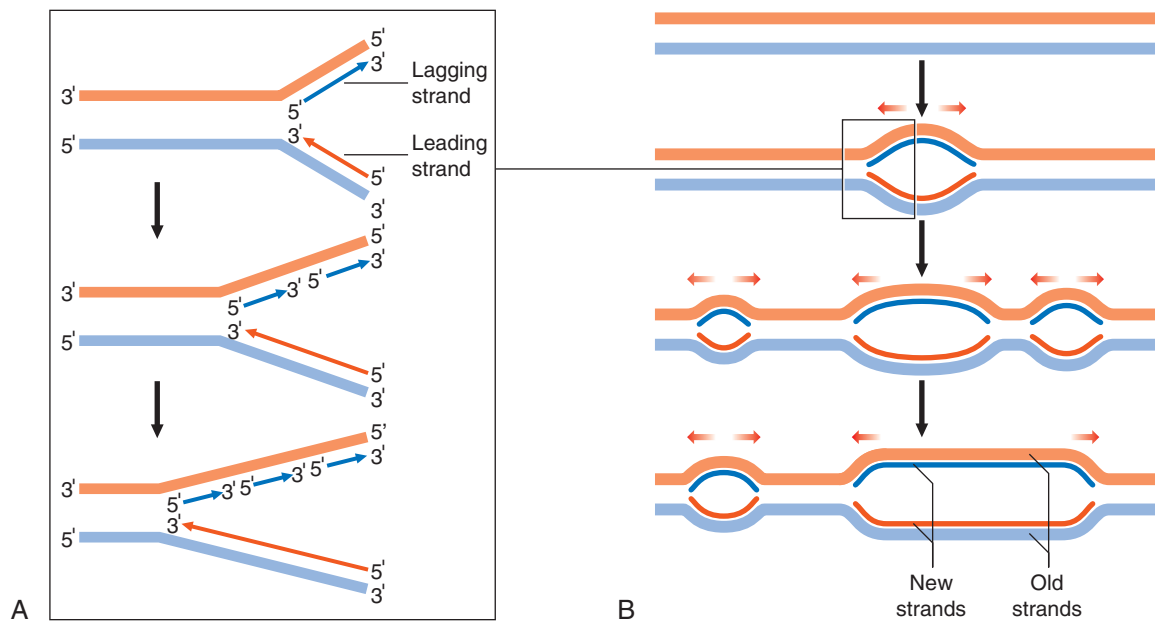
DNA replication progresses in both directions from these points of origin, forming bubble-shaped structures, or **replication bubbles** (see Figure 2.3B). Neighboring replication origins are approximately 50 to 300 kilobases (kb) apart and occur in clusters or **replication units** of 20 to 80 origins of replication. DNA replication in individual replication units takes place at different times in the S phase of the cell cycle (p. 30), adjacent replication units fusing until all the DNA is copied, forming two complete identical daughter molecules.

## Chromosome Structure

The idea that each chromosome is composed of a single DNA double helix is an oversimplification. A chromosome is very



**FIGURE 2.2** DNA double helix. **A**, Sugar-phosphate backbone and nucleotide pairing of the DNA double helix (*P*, phosphate; *A*, adenine; *T*, thymine; *G*, guanine; *C*, cytosine). **B**, Representation of the DNA double helix.



**FIGURE 2.3** DNA replication. **A**, Detailed diagram of DNA replication at the site of origin in the replication fork showing asymmetric strand synthesis with the continuous synthesis of the leading strand and the discontinuous synthesis of the lagging strand with ligation of the Okazaki fragments. **B**, Multiple points of origin and semiconservative mode of DNA replication.

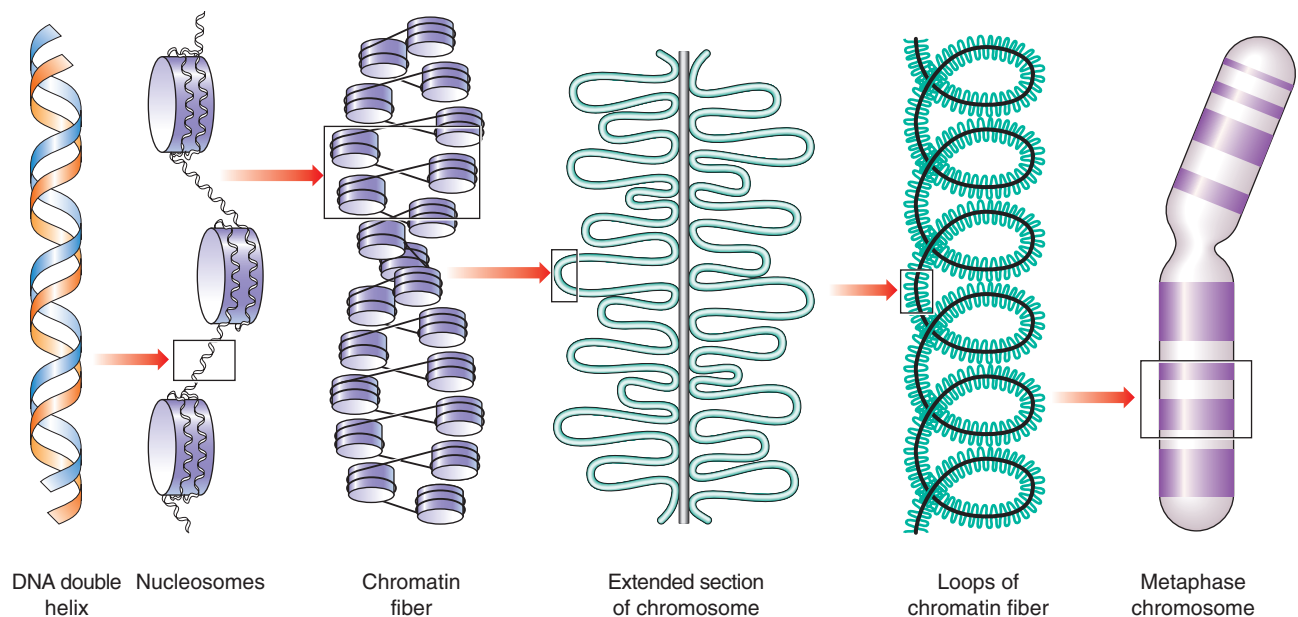
much wider than the diameter of a DNA double helix. In addition, the amount of DNA in the nucleus of each cell in humans means that the total length of DNA contained in the chromosomes, if fully extended, would be several meters long! In fact, the total length of the human chromosome complement is less than half a millimeter.

The packaging of DNA into chromosomes involves several orders of DNA coiling and folding. In addition to the primary coiling of the DNA double helix, there is secondary coiling around spherical **histone** 'beads', forming what are called **nucleosomes**. There is a tertiary coiling of the nucleosomes to form the **chromatin fibers** that form long loops on a scaffold of nonhistone acidic proteins, which are further wound in a

tight coil to make up the chromosome as visualized under the light microscope (**Figure 2.4**), the whole structure making up the so-called **solenoid model** of chromosome structure.

### Types of DNA Sequence

DNA, if denatured, will reassociate as a duplex at a rate that is dependent on the proportion of unique and repeat sequences present, the latter occurring more rapidly. Analysis of the results of the kinetics of the reassociation of human DNA have shown that approximately 60% to 70% of the human genome consists of single- or low-copy number DNA sequences. The remainder of the genome, 30% to 40%, consists of either



**FIGURE 2.4** Simplified diagram of proposed solenoid model of DNA coiling that leads to the visible structure of the chromosome.

**Box 2.1** Types of DNA Sequence**Nuclear (~3 × 10<sup>9</sup> bp)**

Genes (~20,000)  
 Unique single copy  
 Multigene families  
 Classic gene families  
 Gene superfamilies

**Extragenic DNA (unique/low copy number or moderate/highly repetitive)**

Tandem repeat  
 Satellite  
 Minisatellite  
 Telomeric  
 Hypervariable  
 Microsatellite  
 Interspersed  
 Short interspersed nuclear elements  
 Long interspersed nuclear elements

**Mitochondrial (16.6 kb, 37 genes)**

Two rRNA genes  
 22 tRNA genes

moderately or highly **repetitive** DNA sequences that are not transcribed. This latter portion consists of mainly satellite DNA and interspersed DNA sequences (Box 2.1).

**Nuclear Genes**

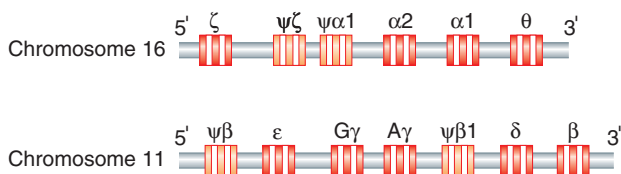
It is estimated that there are between 20,000 and 25,000 genes in the nuclear genome. The distribution of these genes varies greatly between chromosomal regions. For example, heterochromatic and centromeric (p. 25) regions are mostly noncoding, with the highest gene density observed in subtelomeric regions. Chromosomes 19 and 22 are gene rich, whereas 4 and 18 are relatively gene poor. The size of genes also shows great variability: from small genes with single exons to the *TTN* gene which encodes the largest known protein in the human body and has not only the largest number of exons (363) in any known gene, but also the single largest exon (17,106 bp).

**Unique Single-Copy Genes**

Most human genes are unique single-copy genes coding for polypeptides that are involved in or carry out a variety of cellular functions. These include enzymes, hormones, receptors, and structural and regulatory proteins.

**Multigene Families**

Many genes have similar functions, having arisen through gene duplication events with subsequent evolutionary divergence making up what are known as **multigene families**. Some are found physically close together in clusters; for example, the  $\alpha$ - and  $\beta$ -globin gene clusters on chromosomes 16 and 11 (Figure 2.5), whereas others are widely dispersed throughout



**FIGURE 2.5** Representation of the  $\alpha$ - and  $\beta$ -globin regions on chromosomes 16 and 11.

the genome occurring on different chromosomes, such as the *HOX* homeobox gene family (p. 107).

Multigene families can be split into two types, **classic gene families** that show a high degree of sequence homology and **gene superfamilies** that have limited sequence homology but are functionally related, having similar structural domains.

**Classic Gene Families**

Examples of classic gene families include the numerous copies of genes coding for the various ribosomal RNAs, which are clustered as tandem arrays at the nucleolar organizing regions on the short arms of the five acrocentric chromosomes (p. 25), and the different transfer RNA (p. 16) gene families, which are dispersed in numerous clusters throughout the human genome.

**Gene Superfamilies**

Examples of gene superfamilies include the HLA (human leukocyte antigen) genes on chromosome 6 (p. 170) and the T-cell receptor genes, which have structural homology with the immunoglobulin (Ig) genes (p. 170). It is thought that these are almost certainly derived from duplication of a precursor gene, with subsequent evolutionary divergence forming the Ig superfamily.

**Gene Structure**

The original concept of a gene as a continuous sequence of DNA coding for a protein was turned on its head in the early 1980s by detailed analysis of the structure of the human  $\beta$ -globin gene. It was revealed that the gene was much longer than necessary to code for the  $\beta$ -globin protein, containing noncoding intervening sequences, or introns, that separate the coding sequences or exons (Figure 2.6). Most human genes contain introns, but the number and size of both introns and exons is extremely variable. Individual introns can be far larger than the coding sequences and some have been found to contain coding sequences for other genes (i.e., genes occurring within genes). Genes in humans do not usually overlap, being separated from each other by an average of 30 kb, although some of the genes in the HLA complex (p. 170) have been shown to be overlapping.

**Pseudogenes**

Particularly fascinating is the occurrence of genes that closely resemble known structural genes but which, in general, are not functionally expressed: so-called **pseudogenes**. These are thought to have arisen in two main ways: either by genes undergoing duplication events that are rendered silent through the acquisition of mutations in coding or regulatory elements, or as the result of the insertion of complementary DNA sequences, produced by the action of the enzyme **reverse transcriptase** on a naturally occurring messenger RNA transcript, that lack the promoter sequences necessary for expression.

**Extragenic DNA**

The estimated 20,000 unique single-copy genes in humans represent less than 2% of the genome encoding proteins. The remainder of the human genome is made up of repetitive DNA sequences that are predominantly transcriptionally inactive. It has been described as **junk** DNA, but some regions show evolutionary conservation and play a critical role in the regulation of temporal and spatial gene expression.

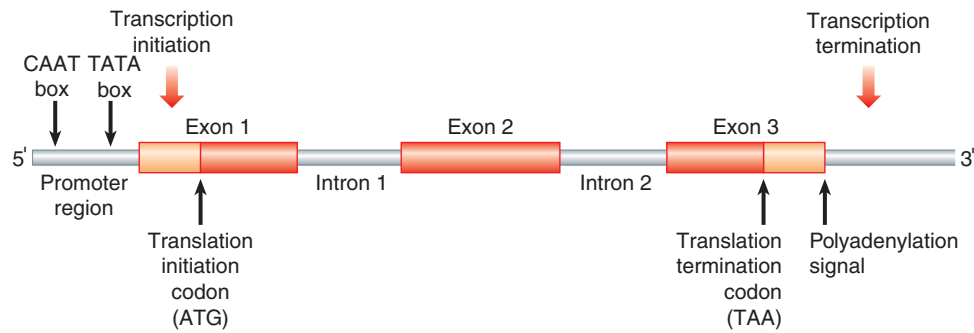


FIGURE 2.6 Representation of a typical human structural gene.

### Tandemly Repeated DNA Sequences

Tandemly repeated DNA sequences consist of blocks of tandem repeats of noncoding DNA that can be either highly dispersed or restricted in their location in the genome. Tandemly repeated DNA sequences can be divided into three subgroups: satellite, minisatellite, and microsatellite DNA.

#### Satellite DNA

**Satellite DNA** accounts for approximately 10% to 15% of the repetitive DNA sequences of the human genome and consists of very large series of simple or moderately complex, short, tandemly repeated DNA sequences that are transcriptionally inactive and are clustered around the centromeres of certain chromosomes. This class of DNA sequences can be separated on density-gradient centrifugation as a shoulder, or 'satellite', to the main peak of genomic DNA, and has therefore been referred to as satellite DNA.

#### Minisatellite DNA

**Minisatellite DNA** consists of two families of tandemly repeated short DNA sequences: telomeric and hypervariable minisatellite DNA sequences that are transcriptionally inactive.

**Telomeric DNA.** The terminal portion of the telomeres of the chromosomes (p. 25) contains 10 to 15 kb of tandem repeats of a 6-base-pair (bp) DNA sequence known as telomeric DNA. The telomeric repeat sequences are necessary for chromosomal integrity in replication and are added to the chromosome by an enzyme known as telomerase (p. 25).

**Hypervariable minisatellite DNA.** Hypervariable minisatellite DNA is made up of highly polymorphic DNA sequences consisting of short tandem repeats of a common core sequence. The highly variable number of repeat units in different hypervariable minisatellites forms the basis of the DNA fingerprinting technique developed by Professor Sir Alec Jeffreys in 1984 (p. 52).

#### Microsatellite DNA

**Microsatellite DNA** consists of tandem single, di-, tri-, and tetra-nucleotide repeat base-pair sequences located throughout the genome. Microsatellite repeats rarely occur within coding sequences but trinucleotide repeats in or near genes are associated with certain inherited disorders (p. 54).

This variation in repeat number is thought to arise by incorrect pairing of the tandem repeats of the two complementary DNA strands during DNA replication, or what is known as

**slipped strand mispairing.** Duplications or deletions of longer sequences of tandemly repeated DNA are thought to arise through unequal crossover of nonallelic DNA sequences on chromatids of homologous chromosomes or sister chromatids (p. 25).

Nowadays DNA microsatellites are used for forensic and paternity tests (p. 52). They can also be helpful for gene tracking in families with a genetic disorder but no identified mutation (p. 52).

### Highly Repeated Interspersed Repetitive DNA Sequences

Approximately one-third of the human genome is made up of two main classes of short and long repetitive DNA sequences that are interspersed throughout the genome.

#### Short Interspersed Nuclear Elements

Approximately 5% of the human genome consists of some 750,000 copies of **short interspersed nuclear elements**, or **SINEs**. The most common are DNA sequences of approximately 300 bp that have sequence similarity to a signal recognition particle involved in protein synthesis. They are called **Alu repeats** because they contain an *AluI* restriction enzyme recognition site.

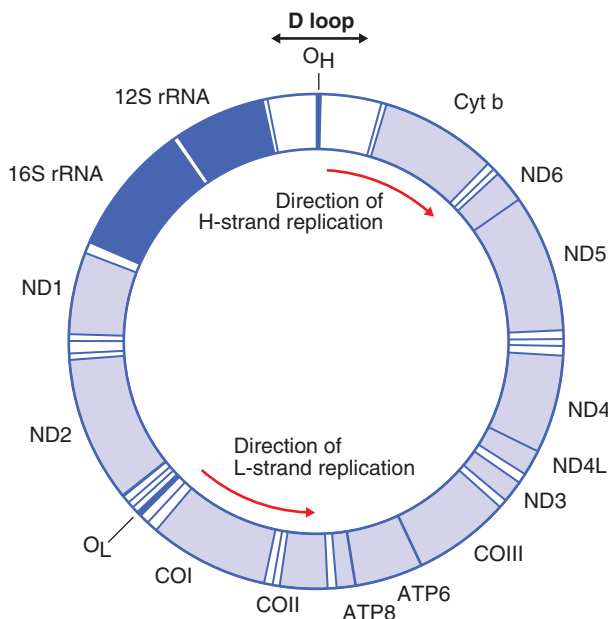
#### Long Interspersed Nuclear Elements

Approximately 5% of the DNA of the human genome is made up of **long interspersed nuclear elements**, or **LINEs**. The most commonly occurring LINE, known as LINE-1 or an L1 element, consists of more than 100,000 copies of a DNA sequence of up to 6000 bp that encodes a reverse transcriptase.

The function of these interspersed repeat sequences is not clear. Members of the *Alu* repeat family are flanked by short direct repeat sequences and therefore resemble unstable DNA sequences called transposable elements or **transposons**. Transposons, originally identified in maize by Barbara McClintock (p. 7), move spontaneously throughout the genome from one chromosome location to another and appear to be ubiquitous in the plant and animal kingdoms. It is postulated that *Alu* repeats could promote unequal recombination, which could lead to pathogenic mutations (p. 17) or provide selective advantage in evolution by gene duplication. Both *Alu* and LINE-1 repeat elements have been implicated as a cause of mutation in inherited human disease.

### Mitochondrial DNA

In addition to nuclear DNA, the several thousand mitochondria of each cell possess their own 16.6 kb circular double-stranded



**FIGURE 2.7** The human mitochondrial genome. *H* is the heavy strand and *L* the light strand.

DNA, **mitochondrial DNA** (or **mtDNA**) (Figure 2.7). The mtDNA genome is very compact, containing little repetitive DNA, and codes for 37 genes, which include two types of ribosomal RNA, 22 transfer RNAs (p. 16) and 13 protein subunits for enzymes, such as cytochrome *b* and cytochrome oxidase, which are involved in the energy producing oxidative phosphorylation pathways. The genetic code of the mtDNA differs slightly from that of nuclear DNA.

The mitochondria of the fertilized zygote are inherited almost exclusively from the oocyte, leading to the maternal

pattern of inheritance that characterizes many mitochondrial disorders (p. 269).

### Transcription

The process whereby genetic information is transmitted from DNA to RNA is called **transcription**. The information stored in the genetic code is transmitted from the DNA of a gene to **messenger RNA**, or **mRNA**. Every base in the mRNA molecule is complementary to a corresponding base in the DNA of the gene, but with uracil replacing thymine in mRNA. mRNA is single stranded, being synthesized by the enzyme RNA polymerase II, which adds the appropriate complementary ribonucleotide to the 3' end of the RNA chain.

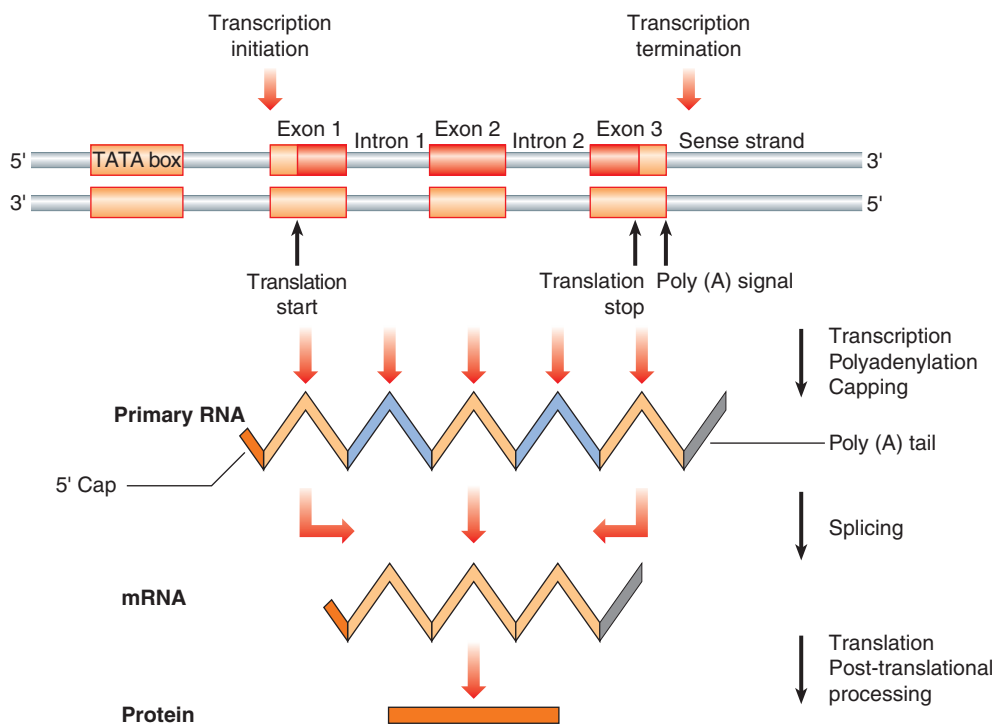
In any particular gene, only one DNA strand of the double helix acts as the so-called **template strand**. The transcribed mRNA molecule is a copy of the complementary strand, or what is called the **sense strand** of the DNA double helix. The template strand is sometimes called the **antisense strand**. The particular strand of the DNA double helix used for RNA synthesis appears to differ throughout different regions of the genome.

### RNA Processing

Before the primary mRNA molecule leaves the nucleus it undergoes a number of modifications, or what is known as RNA processing. This involves splicing, capping, and polyadenylation.

### mRNA Splicing

During and after transcription, the noncoding introns in the precursor (pre) mRNA are excised, and the noncontiguous coding exons are spliced together to form a shorter mature mRNA before its transportation to the ribosomes in the cytoplasm for translation. The process is known as **mRNA splicing** (Figure 2.8). The boundary between the introns and exons



**FIGURE 2.8** Transcription, post-transcriptional processing, translation, and post-translational processing.



consists of a 5' donor GT dinucleotide and a 3' acceptor AG dinucleotide. These, along with surrounding short splicing consensus sequences, another intronic sequence known as the branch site, small nuclear RNA (snRNA) molecules and associated proteins, are necessary for the splicing process.

### 5' Capping

The 5' cap is thought to facilitate transport of the mRNA to the cytoplasm and attachment to the ribosomes, as well as to protect the RNA transcript from degradation by endogenous cellular exonucleases. After 20 to 30 nucleotides have been transcribed, the nascent mRNA is modified by the addition of a guanine nucleotide to the 5' end of the molecule by an unusual 5' to 5' triphosphate linkage. A methyltransferase enzyme then methylates the N7 position of the guanine, giving the final 5' cap.

### Polyadenylation

Transcription continues until specific nucleotide sequences are transcribed that cause the mRNA to be cleaved and RNA polymerase II to be released from the DNA template. Approximately 200 adenylate residues—the so-called poly(A) tail—are added to the mRNA, which facilitates nuclear export and translation.

## Translation

**Translation** is the transmission of the genetic information from mRNA to protein. Newly processed mRNA is transported from the nucleus to the cytoplasm, where it becomes associated with the **ribosomes**, which are the site of protein synthesis.

Ribosomes are made up of two different sized subunits, which consist of four different types of **ribosomal RNA (rRNA)** molecules and a large number of ribosomal specific proteins. Groups of ribosomes associated with the same molecule of mRNA are referred to as **polyribosomes** or **polysomes**. In the ribosomes, the mRNA forms the template for producing the specific sequence of amino acids of a particular **polypeptide**.

### Transfer RNA

In the cytoplasm there is another form of RNA called **transfer RNA**, or **tRNA**. The incorporation of amino acids into a **polypeptide chain** requires the amino acids to be covalently bound by reacting with ATP to the specific tRNA molecule by the activity of the enzyme aminoacyl tRNA synthetase. The ribosome, with its associated rRNAs, moves along the mRNA, the amino acids linking up by the formation of peptide bonds through the action of the enzyme peptidyl transferase to form a polypeptide chain (Figure 2.9).

### Post-translational Modification

Many proteins, before they attain their normal structure or functional activity, undergo **post-translational modification**, which can include chemical modification of amino-acid side chains (e.g., hydroxylation, methylation), the addition of carbohydrate or lipid moieties (e.g., glycosylation), or proteolytic cleavage of polypeptides (e.g., the conversion of proinsulin to insulin).

Thus post-translational modification, along with certain short amino-acid sequences known as **localization sequences** in the newly synthesized proteins, results in transport to specific cellular locations (e.g., the nucleus), or secretion from the cell.

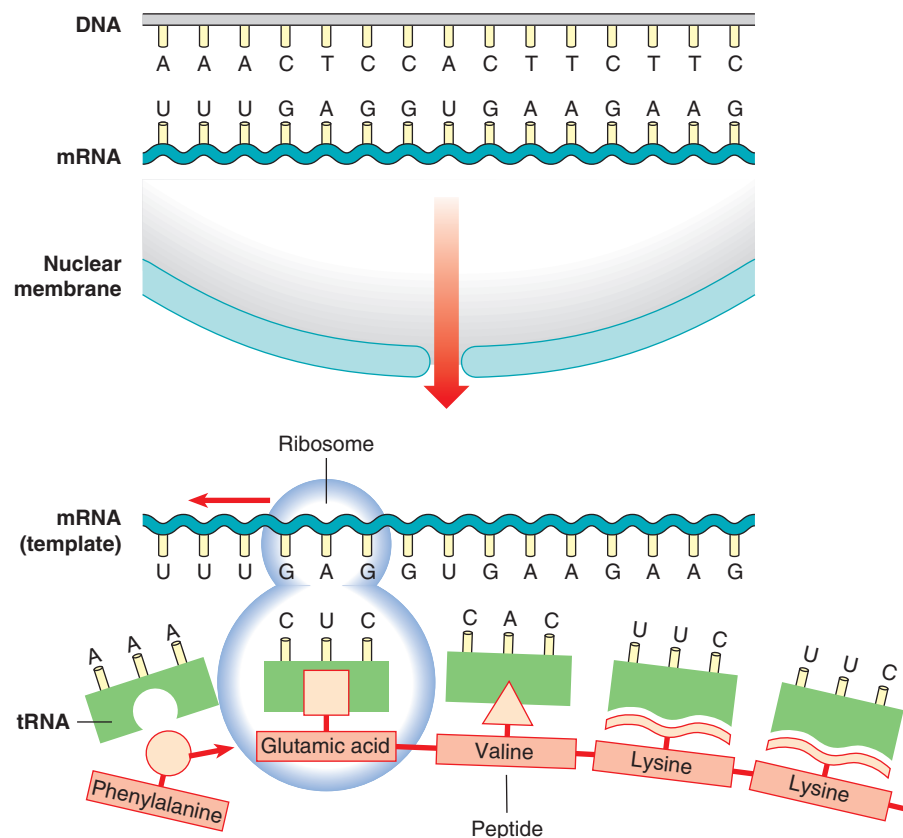


FIGURE 2.9 Representation of the way in which genetic information is translated into protein.

**Table 2.1** Genetic Code of the Nuclear and Mitochondrial Genomes

First Base	Second Base				Third Base
	U	C	A	G	
U	Phenylalanine	Serine	Tyrosine	Cysteine	U
	Phenylalanine	Serine	Tyrosine	Cysteine	C
	Leucine	Serine	Stop	Stop ( <i>Tryptophan</i> )	A
	Leucine	Serine	Stop	Tryptophan	G
C	Leucine	Proline	Histidine	Arginine	U
	Leucine	Proline	Histidine	Arginine	C
	Leucine	Proline	Glutamine	Arginine	A
	Leucine	Proline	Glutamine	Arginine	G
A	Isoleucine	Threonine	Asparagine	Serine	U
	Isoleucine	Threonine	Asparagine	Serine	C
	Isoleucine ( <i>Methionine</i> )	Threonine	Lysine	Arginine	A
	Methionine	Threonine	Lysine	Arginine ( <i>Stop</i> )	G
G	Valine	Alanine	Aspartic acid	Glycine	U
	Valine	Alanine	Aspartic acid	Glycine	C
	Valine	Alanine	Glutamic acid	Glycine	A
	Valine	Alanine	Glutamic acid	Glycine	G

Differences in the mitochondrial genetic code are in *italics*.

## The Genetic Code

Twenty different amino acids are found in proteins; as DNA is composed of four different nitrogenous bases, obviously a single base cannot specify one amino acid. If two bases were to specify one amino acid, there would only be 42 or 16 possible combinations. If, however, three bases specified one amino acid then the possible number of combinations of the four bases would be 43 or 64. This is more than enough to account for all the 20 known amino acids and is known as the genetic code.

### Triplet Codons

The triplet of nucleotide bases in the mRNA that codes for a particular amino acid is called a **codon**. Each triplet codon in sequence codes for a specific amino acid in sequence and so the genetic code is nonoverlapping. The order of the triplet codons in a gene is known as the translational **reading frame**. However, some amino acids are coded for by more than one triplet, so the code is said to be **degenerate** (Table 2.1). Each tRNA species for a particular amino acid has a specific trinucleotide sequence called the **anticodon**, which is complementary to the codon of the mRNA. Although there are 64 codons, there are only 30 cytoplasmic tRNAs, the anticodons of a number of the tRNAs recognizing codons that differ at the position of the third base, with guanine being able to pair with uracil as well as cytosine. Termination of translation of the mRNA is signaled by the presence of one of the three **stop** or **termination codons**.

The genetic code of mtDNA differs from that of the nuclear genome. Eight of the 22 tRNAs are able to recognize codons that differ only at the third base of the codon, 14 can recognize pairs of codons that are identical at the first two bases, with either a purine or pyrimidine for the third base, the other four codons acting as stop codons (see Table 2.1).

## Regulation of Gene Expression

Many cellular processes, and therefore the genes that are expressed, are common to all cells, for example ribosomal, chromosomal and cytoskeleton proteins, constituting what are

called the **housekeeping genes**. Some cells express large quantities of a specific protein in certain tissues or at specific times in development, such as hemoglobin in red blood cells (p. 154). This differential control of gene expression can occur at a variety of stages.

### Control of Transcription

The control of transcription can be affected permanently or reversibly by a variety of factors, both environmental (e.g., hormones) and genetic (cell signaling). This occurs through a number of different mechanisms that include signaling molecules that bind to regulatory sequences in the DNA known as **response elements**, intracellular receptors known as **hormone nuclear receptors**, and receptors for specific ligands on the cell surface involved in the process of **signal transduction**.

All of these mechanisms ultimately affect transcription through the binding of the general transcription factors to short specific DNA promoter elements located within 200 bp 5' or **upstream** of most eukaryotic genes in the so-called core **promoter region** that leads to activation of RNA polymerase (Figure 2.10). Promoters can be broadly classed into two types, TATA box-containing and GC rich. The TATA box, which is approximately 25 bp upstream of the transcription start site, is involved in the initiation of transcription at a basal constitutive level and mutations in it can lead to alteration of the transcription start site. The GC box, which is approximately 80 bp upstream, increases the basal level of transcriptional activity of the TATA box.

The regulatory elements in the promoter region are said to be **cis-acting**, that is, they only affect the expression of the adjacent gene on the same DNA duplex, whereas the transcription factors are said to be **trans-acting**, acting on both copies of a gene on each chromosome being synthesized from genes that are located at a distance. DNA sequences that increase transcriptional activity, such as the GC and CAAT boxes, are known as **enhancers**. There are also negative regulatory elements or **silencers** that inhibit transcription. In addition, there are short sequences of DNA, usually 500 bp to 3 kb in size and known as **boundary elements**, which block or inhibit the influence of regulatory elements of adjacent genes.

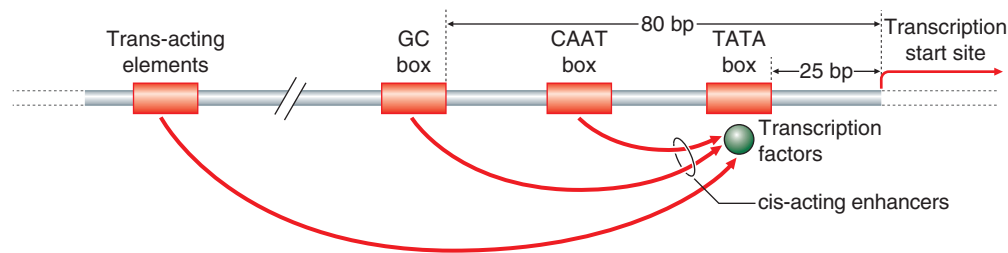


FIGURE 2.10 Diagrammatic representation of the factors that regulate gene expression.

## Transcription Factors

A number of genes encode proteins involved in the regulation of gene expression. They have DNA-binding activity to short nucleotide sequences, usually mediated through helical protein motifs, and are known as **transcription factors**. These gene regulatory proteins have a transcriptional activation domain and a DNA-binding domain. There are four types of DNA-binding domain, the most common being the **helix–turn–helix**, made up of two  $\alpha$  helices connected by a short chain of amino acids that make up the ‘turn’. The three other types are the **zinc finger**, **leucine zipper**, or **helix–loop–helix** motifs, so named as a result of specific structural features.

## Post-transcriptional Control of Gene Expression

Regulation of expression of most genes occurs at the level of transcription but can also occur at the levels of RNA processing, RNA transport, mRNA degradation and translation. For example, the G to A variant at position 20,210 in the 3′ untranslated region of the prothrombin gene increases the stability of the mRNA transcript, resulting in higher plasma prothrombin levels.

## RNA-Mediated Control of Gene Expression

RNA-mediated silencing was first described in the early 1990s, but it is only recently that its key role in controlling post-transcriptional gene expression has been both recognized and exploited (see [Chapter 15](#)). Small interfering RNAs (siRNAs) were discovered in 1998 and are the effector molecules of the RNA interference pathway (RNAi). These short double-stranded RNAs (21 to 23 nucleotides) bind to mRNAs in a sequence-specific manner and result in their degradation via a ribonuclease-containing RNA-induced silencing complex (RISC). MicroRNAs (miRNAs) also bind to mRNAs in a sequence-specific manner. They can either cause endonucleolytic cleavage of the mRNA or act by blocking translation.

## Alternative Isoforms

Most (~95%) human genes undergo **alternative splicing** and therefore encode more than one protein. **Alternative polyadenylation** generates further diversity. Some genes have more than one promoter, and these **alternative promoters** may result in tissue-specific isoforms. Alternative splicing of exons is also seen with individual exons present in only some isoforms. The extent of alternative splicing in humans may be inferred from the finding that the human genome includes only approximately 20,000 genes, far fewer than the original prediction of more than 100,000.

## RNA-Directed DNA Synthesis

The process of the transfer of the genetic information from DNA to RNA to protein has been called the **central dogma**. It was initially believed that genetic information was transferred only from DNA to RNA and thence translated into protein. However, there is evidence from the study of certain types of virus—retroviruses—that genetic information can occasionally flow in the reverse direction, from RNA to DNA ([p. 178](#)). This is referred to as **RNA-directed DNA synthesis**. It has been suggested that regions of DNA in normal cells serve as templates for the synthesis of RNA, which in turn then acts as a template for the synthesis of DNA that later becomes integrated into the nuclear DNA of other cells. Homology between human and retroviral oncogene sequences could reflect this process ([p. 179](#)), which could be an important therapeutic approach for the treatment of inherited disease in humans.

## Mutations

A **mutation** is defined as a heritable alteration or change in the genetic material. Mutations drive evolution but can also be pathogenic. Mutations can arise through exposure to mutagenic agents ([p. 21](#)), but the vast majority occur spontaneously through errors in DNA replication and repair. Sequence variants with no obvious effect upon phenotype may be termed polymorphisms.

**Somatic mutations** may cause adult-onset disease, such as cancer, but cannot be transmitted to offspring. A mutation in **gonadal tissue** or a **gamete** can be transmitted to future generations unless it affects fertility or survival into adulthood. Harmful alleles of all kinds constitute the so-called genetic load of the population. There are also rare examples of ‘back mutation’ in patients with recessive disorders. For example, reversion of inherited deleterious mutations has been demonstrated in phenotypically normal cells present in a small number of patients with Fanconi anemia.

## Types of Mutation

Mutations can range from single base substitutions, through insertions and deletions of single or multiple bases to loss or gain of entire chromosomes ([Table 2.2](#)). Base substitutions are most prevalent ([Table 2.3](#)) and missense mutations account for nearly half of all mutations. A standard nomenclature to describe mutations ([Table 2.4](#)) has been agreed on (see <http://varnomen.hgvs.org/>). Examples of chromosome abnormalities are discussed in [Chapter 3](#).

## Substitutions

A **substitution** is the replacement of a single nucleotide by another. These are the most common type of mutation. If the

**Table 2.2** Main Classes, Groups, and Types of Mutation and Effects on Protein Product

Class	Group	Type	Effect on Protein Product
Substitution	Synonymous	Silent*	Same amino acid
		Nonsynonymous	Altered amino acid—may affect protein function or stability
	Nonsynonymous	Missense*	Stop codon—loss of function or expression due to degradation of mRNA
		Nonsense*	Aberrant splicing—exon skipping or intron retention
Deletion	Multiple of 3 (codon)	Splice site	Altered gene expression
		Promoter	Altered gene expression
	Not multiple of 3	Enhancer	In-frame deletion of one or more amino acid(s)—may affect protein function or stability
		Frameshift	Likely to result in premature termination with loss of function or expression
Insertion	Multiple of 3 (codon)	Partial gene deletion	May result in premature termination with loss of function or expression
		Whole gene deletion	Loss of expression
	Not multiple of 3	Frameshift	In-frame insertion of one or more amino acid(s)—may affect protein function or stability
		Partial gene duplication	Likely to result in premature termination with loss of function or expression
Expansion of trinucleotide repeat	Dynamic mutation	Whole gene duplication	May have an effect because of increased gene dosage
		Dynamic mutation	Altered gene expression or altered protein stability or function

\*Some have been shown to cause aberrant splicing.

**Table 2.3** Frequency of Different Types of Mutation

Type of Mutation	Percentage of Total
Missense or nonsense	56
Splicing	10
Regulatory	2
Small deletions, insertions, or indels*	24
Gross deletions or insertions	7
Other (complex rearrangements or repeat variations)	<1

Data from <http://www.hgmd.org>.

\*Indels are mutations that involve both an insertion and a deletion of nucleotides.

substitution involves replacement by the same type of nucleotide—a pyrimidine for a pyrimidine (C for T or *vice versa*) or a purine for a purine (A for G or *vice versa*); this is termed a **transition**. Substitution of a pyrimidine by a purine or *vice versa* is termed a **transversion**. Transitions occur more frequently than **transversions**. This may be due to the relatively high frequency of C to T transitions, which is likely to be the result of the nucleotides cytosine and guanine occurring together, or what are known as CpG dinucleotides (p

represents the phosphate) frequently being methylated in genomic DNA with spontaneous deamination of methylcytosine converting them to thymine. CpG dinucleotides have been termed ‘hotspots’ for mutation.

### Deletions

A deletion involves the loss of one or more nucleotides. If this occurs in coding sequences and involves one, two, or more nucleotides that are not a multiple of three, the reading frame will be disrupted. Larger deletions may result in partial or whole gene deletions and may arise through unequal crossover between repeat sequences (e.g., hereditary neuropathy with liability to pressure palsies; see p. 275).

### Insertions

An **insertion** involves the addition of one or more nucleotides into a gene. Again, if an insertion occurs in a coding sequence and involves one, two, or more nucleotides that are not a multiple of three, it will disrupt the reading frame. Large insertions can also result from unequal crossover (e.g., hereditary sensory and motor neuropathy type 1a; see p. 275) or the insertion of transposable elements (p. 14).

In 1991, expansion of trinucleotide repeat sequences was identified as a mutational mechanism. A number of single-gene

**Table 2.4** Mutation Nomenclature: Examples of CFTR Gene Mutations

Type of Mutation	Nucleotide	Protein Designation	Consequence Description
Missense	c.482G>A	p.Arg117His	Arginine to histidine
Nonsense	c.1756G>T	p.Gly542X	Glycine to stop
Splicing	c.621 + 1G>T		Splice donor site mutation
Deletion (1 bp)	c.1078T	p.Val358TyrfsX11	Frameshift mutation
Deletion (3 bp)	c.1652_1654delCTT	p.Phe508del	In-frame deletion of phenylalanine
Insertion	c.3905_3906insT	p.Leu1258PhefsX7	Frameshift mutation

Mutations can be designated according to the genomic or cDNA (mRNA) sequence and are prefixed by ‘g.’ or ‘c.’, respectively. The first base of the start codon (ATG) is c.1. However, for historical reasons this is not always the case, and the first base of the *CFTR* cDNA is actually nucleotide 133.

disorders have subsequently been shown to be associated with triplet repeat expansions (Table 2.5). These are described as **dynamic mutations** because the repeat sequence becomes more unstable as it expands in size. The mechanism by which amplification or expansion of the triplet repeat sequence occurs is not clear at present. Triplet repeats below a certain length for each disorder are faithfully and stably transmitted in mitosis and meiosis. Above a certain repeat number for each disorder, they are more likely to be transmitted unstably, usually with an increase or decrease in repeat number. A variety of possible explanations has been offered as to how the increase in triplet repeat number occurs. These include unequal crossover or unequal sister chromatid exchange (see Chapter 17) in nonreplicating DNA, and slipped-strand mispairing and polymerase slippage in replicating DNA.

Triplet repeat expansions usually take place over a number of generations within a family, providing an explanation for some unusual aspects of patterns of inheritance as well as possibly being the basis of the previously unexplained phenomenon of anticipation (p. 75).

The exact mechanisms by which repeat expansions cause disease are not completely understood. Unstable trinucleotide repeats may be within coding or noncoding regions of genes and hence vary in their pathogenic mechanisms. Expansion of the CAG repeat in the coding region of the *HTT* gene and some *SCA* genes results in a protein with an elongated polyglutamine tract that forms toxic aggregates within certain cells, causing Huntington disease or spinocerebellar ataxia. In fragile X the CGG repeat expansion in the 5' untranslated region (UTR) results in methylation of promoter sequences and lack of expression of the *FMR1* protein. In myotonic dystrophy (MD) it is thought that a gain-of-function RNA mechanism results from both the CTG expansion in the 3' UTR of the *DMPK* (type 1 MD) and the CCTG expansion within intron 1 of the *CNBP* gene (formerly *ZNF9*; type 2 MD). The expanded transcripts bind splice regulatory proteins to form RNA-protein complexes that accumulate in the nuclei of cells. The disruption of these splice regulators causes abnormal developmental processing where embryonic isoforms of the

resulting proteins are expressed in adult myotonic dystrophy tissues. The immature proteins then appear to cause the clinical features common to both diseases (p. 285).

The spectrum of repeat expansion mutations also includes a dodecamer repeat expansion upstream from the cystatin B gene that causes progressive myoclonus epilepsy (EPM1) and a pentanucleotide repeat expansion in intron 9 of the *ATXN10* gene shown in families with spinocerebellar ataxia type 10. Spinocerebellar ataxia is an extremely heterogeneous disorder and, in addition to the dynamic mutations shown in Table 2.5, nonrepeat expansion mutations have been reported in four additional genes.

### Structural Effects of Mutations on the Protein

Mutations can also be subdivided into two main groups according to the effect on the polypeptide sequence of the encoded protein, being either *synonymous* or *nonsynonymous*.

### Synonymous or Silent Mutations

If a mutation does not alter the polypeptide product of the gene, it is termed a **synonymous** or **silent mutation**. A single base-pair substitution, particularly if it occurs in the third position of a codon because of the degeneracy of the genetic code, will often result in another triplet that codes for the same amino acid with no alteration in the properties of the resulting protein.

### Nonsynonymous Mutations

If a mutation leads to an alteration in the encoded polypeptide, it is known as a **nonsynonymous mutation**. Nonsynonymous mutations are observed to occur less frequently than synonymous mutations. Synonymous mutations are selectively neutral, whereas alteration of the amino-acid sequence of the protein product of a gene is likely to result in abnormal function, which is usually associated with disease, or lethality, which has an obvious selective disadvantage.

Nonsynonymous mutations can occur in one of three main ways.

**Table 2.5** Examples of Diseases Arising From Repeat Expansions

Disease (Gene)	Repeat Sequence	Normal Range (Repeats)	Pathogenic Range (Repeats)	Repeat Location
Huntington disease ( <i>HTT</i> )	CAG	9–35	36–100	Coding
Myotonic dystrophy type 1 ( <i>DMPK</i> )	CTG	5–35	50–4000	3' UTR
Myotonic dystrophy type 2 ( <i>CNBP</i> )	CCTG	11–26	75–>11000	Intron 1
Fragile X site A ( <i>FMR1</i> )	CGG	10–50	200–2000	5' UTR
Kennedy disease ( <i>AR</i> )	CAG	13–30	40–62	Coding
Spinocerebellar ataxia 1 ( <i>ATXN1</i> )	CAG	6–36	39–80	Coding
Spinocerebellar ataxia 2 ( <i>ATXN2</i> )	CAG	13–31	32–79	Coding
Machado–Joseph disease/Spinocerebellar ataxia 3 ( <i>ATXN3</i> )	CAG	14–44	52–86	Coding
Spinocerebellar ataxia 6 ( <i>CACNA1A</i> )	CAG	4–18	19–33	Coding
Spinocerebellar ataxia 7 ( <i>ATXN7</i> )	CAG	7–17	38–220	Coding
Spinocerebellar ataxia 8 ( <i>ATXN8</i> )	CTG	15–50	71–1300	3' UTR
Spinocerebellar ataxia 10 ( <i>ATXN10</i> )	ATTCT	10–29	400–4500	Intron 9
Spinocerebellar ataxia 12 ( <i>PPP2R2B</i> )	CAG	7–32	51–78	5' UTR
Spinocerebellar ataxia 17 ( <i>TBP</i> )	CAG	25–44	47–63	Coding
Dentatorubral-pallidoluysian atrophy ( <i>ATN1</i> )	CAG	7–23	53–88	Coding
Friedreich ataxia ( <i>FXN1</i> )	GAA	5–30	70–>1000	Intron 1
Fragile X site E ( <i>AFF2</i> )	CCG	6–25	>200	Promoter
Oculopharyngeal muscular dystrophy ( <i>PABPN1</i> )	GCG	6	8–13	Coding

UTR, Untranslated region.

### Missense

A single base-pair substitution can result in coding for a different amino acid and the synthesis of an altered protein, a so-called **missense** mutation. If the mutation codes for an amino acid that is chemically dissimilar, for example has a different charge, the structure of the protein will be altered. This is termed a **nonconservative substitution** and can lead to a gross reduction, or even a complete loss, of biological activity. Single base-pair mutations can lead to qualitative rather than quantitative changes in the function of a protein, such that it retains its normal biological activity (e.g., enzyme activity) but differs in characteristics such as its mobility on electrophoresis, its pH optimum, or its stability so that it is more rapidly broken down *in vivo*. Many of the abnormal hemoglobins (p. 156) are the result of missense mutations.

Some single base-pair substitutions result in the replacement of a different amino acid that is chemically similar, and may have no functional effect. These are termed **conservative** substitutions.

### Nonsense

A substitution that leads to the generation of one of the stop codons (see Table 2.1) will result in premature termination of translation of a peptide chain, or what is termed a **nonsense** mutation. In most cases the shortened chain is unlikely to retain normal biological activity, particularly if the termination codon results in the loss of an important functional domain(s) of the protein. mRNA transcripts containing premature termination codons are frequently degraded by a process known as **nonsense-mediated decay**. This is a form of RNA surveillance that is believed to have evolved to protect the body from the possible consequences of truncated proteins interfering with normal function.

### Frameshift

If a mutation involves the insertion or deletion of nucleotides that are not a multiple of three, it will disrupt the reading frame and constitute what is known as a **frameshift** mutation. The amino-acid sequence of the protein subsequent to the mutation bears no resemblance to the normal sequence and may have an adverse effect on its function. Most frameshift mutations result in a premature stop codon downstream to the mutation. This may lead to expression of a truncated protein, unless the mRNA is degraded by nonsense-mediated decay.

## Mutations in Noncoding DNA

Mutations in promoter sequences, enhancers or other regulatory regions can affect the level of gene expression. With our new knowledge of the role of RNA interference in gene expression, it has become apparent that mutations in miRNA or siRNA binding sites within UTRs can also result in disease.

### Splicing Mutations

Mutations of the highly conserved splice donor (GT) and splice acceptor (AG) sites (p. 15) usually result in aberrant splicing. This can result in the loss of coding sequence (exon skipping) or retention of intronic sequence, and may lead to frameshift mutations. **Cryptic splice** sites, which resemble the sequence of an authentic splice site, may be activated when the conserved splice sites are mutated. In addition, base substitutions resulting in apparent silent, missense, and nonsense mutations can cause aberrant splicing through mutation of **exon splicing enhancer** sequences. These purine-rich sequences are required

for the correct splicing of exons with weak splice-site consensus sequences.

## Functional Effects of Mutations on the Protein

Mutations exert their phenotypic effect in one of two ways, through either loss or gain of function.

### Loss-of-Function Mutations

**Loss-of-function** mutations can result in either reduced activity or complete loss of the gene product. The former can be the result of reduced activity or of decreased stability of the gene product and is known as a **hypomorph**, the latter being known as a **null allele** or **amorph**. Loss-of-function mutations involving enzymes are usually inherited in an autosomal or X-linked recessive manner, because the catalytic activity of the product of the normal allele is more than adequate to carry out the reactions of most metabolic pathways.

### Haplo-insufficiency

Loss-of-function mutations in the heterozygous state in which half normal levels of the gene product result in phenotypic effects are termed **haplo-insufficiency mutations**. The phenotypic manifestations sensitive to gene dosage are a result of mutations occurring in genes that code for either receptors, or more rarely enzymes, the functions of which are rate limiting; for example, familial hypercholesterolemia (p. 262) and acute intermittent porphyria (p. 266).

In a number of autosomal dominant disorders, the mutational basis of the functional abnormality is the result of haplo-insufficiency in which, not surprisingly, homozygous mutations result in more severe phenotypic effects; examples are angio-neurotic edema and familial hypercholesterolemia (p. 262).

### Gain-of-Function Mutations

**Gain-of-function** mutations, as the name suggests, result in either increased levels of gene expression or the development of a new function(s) of the gene product. Increased expression levels from activating point mutations or increased gene dosage are responsible for one type of Charcot-Marie-Tooth disease, hereditary motor, and sensory neuropathy type I (p. 275). The expanded triplet repeat mutations in the Huntington gene (*HTT*) cause qualitative changes in the gene product that result in its aggregation in the central nervous system leading to the classic clinical features of the disorder (p. 273).

Mutations that alter the timing or tissue specificity of the expression of a gene can also be considered to be gain-of-function mutations. Examples include the chromosomal rearrangements that result in the combination of sequences from two different genes seen with specific tumors (p. 180). The novel function of the resulting chimeric gene causes the neoplastic process.

Gain-of-function mutations are dominantly inherited and the rare instances of gain-of-function mutations occurring in the homozygous state are often associated with a much more severe phenotype, which is often a prenatally lethal disorder, for example homozygous achondroplasia (pp. 113–114).

### Dominant-Negative Mutations

A **dominant-negative** mutation is one in which a mutant gene in the heterozygous state results in the loss of protein activity or function, as a consequence of the mutant gene product interfering with the function of the normal gene product of the

corresponding allele. Dominant-negative mutations are particularly common in proteins that are dimers or multimers, for instance structural proteins such as the collagens, mutations in which can lead to osteogenesis imperfecta.

### Genotype–Phenotype Correlation

Many genetic disorders are well recognized as being very variable in severity, or in the particular features manifested by a person with the disorder (p. 68). Developments in molecular genetics increasingly allow identification of the mutational basis of the specific features that occur in a person with a particular inherited disease, or what is known as the phenotype. This has resulted in attempts to correlate the presence of a particular mutation, which is often called the genotype, with the specific features seen in a person with an inherited disorder, this being referred to as **genotype–phenotype correlation**. This can be important in the management of a patient. One example includes the association of mutations in the *BRCA1* gene with the risk of developing ovarian cancer as well as breast cancer (p. 192). Particularly striking examples are mutations in the receptor tyrosine kinase gene *RET* which, depending on their location, can lead to four different syndromes that differ in the functional mechanism and clinical phenotype. Loss-of-function nonsense mutations lead to lack of migration of neural-crest-derived cells to form the ganglia of the myenteric plexus of the large bowel, leading to Hirschsprung disease, whereas gain-of-function missense mutations result in familial medullary thyroid carcinoma or one of the two types of multiple endocrine neoplasia type 2 (p. 119). Mutations in the *LMNA* gene are associated with an even broader spectrum of disease (p. 66).

### Mutations and Mutagenesis

Naturally occurring mutations are referred to as **spontaneous mutations** and are thought to arise through chance errors in chromosomal division or DNA replication. Environmental agents that cause mutations are known as mutagens. These include natural or artificial ionizing radiation and chemical or physical mutagens.

### Radiation

**Ionizing radiation** includes electromagnetic waves of very short wavelength (x-rays and  $\gamma$ -rays) and high-energy particles ( $\alpha$  particles,  $\beta$  particles, and neutrons). X-rays,  $\gamma$ -rays, and neutrons have great penetrating power, but  $\alpha$  particles can penetrate soft tissues to a depth of only a fraction of a millimeter and  $\beta$  particles only up to a few millimeters.

**Dosimetry** is the measurement of radiation. The dose of radiation is expressed in relation to the amount received by the gonads because it is the effects of radiation on germ cells rather than somatic cells that are important as far as transmission of mutations to future progeny is concerned. The **gonad dose** of radiation is often expressed as the amount received in 30 years. This period has been chosen because it corresponds roughly to the generation time in humans.

The various sources and average annual doses of the different types of natural and artificial ionizing radiation are listed in Table 2.6. Natural sources of radiation include cosmic rays, external radiation from radioactive materials in certain rocks, and internal radiation from radioactive materials in tissues. Artificial sources include diagnostic and therapeutic radiology, occupational exposure and fallout from nuclear explosions.

The average gonadal dose of ionizing radiation from radioactive fallout resulting from the testing of nuclear weapons is less

**Table 2.6** Approximate Average Doses of Ionizing Radiation From Various Sources to the Gonads of the General Population

Source of Radiation	Average Dose per Year (mSv)	Average Dose per 30 Years (mSv)
<i>Natural</i>		
Cosmic radiation	0.25	7.5
External $\gamma$ radiation*	1.50	45.0
Internal $\gamma$ radiation	0.30	9.0
<i>Artificial</i>		
Medical radiology	0.30	9.0
Radioactive fallout	0.01	0.3
Occupational and miscellaneous	0.04	1.2
Total	2.40	72.0

Data from Clarke RH, Southwood TRE 1989 Risks from ionizing radiation. Nature 338:197–198.

\*Including radon in dwellings.

than that from any of the sources of background radiation. However, the possibility of serious accidents involving nuclear reactors, as occurred at Three Mile Island in the United States in 1979 and at Chernobyl in the Soviet Union in 1986, with widespread effects, must always be borne in mind.

### Genetic Effects

Experiments with animals and plants have shown that the number of mutations produced by irradiation is proportional to the dose: the larger the dose, the greater the number of mutations produced. It is believed that there is no threshold below which irradiation has no effect—even the smallest dose of radiation can result in a mutation. The genetic effects of ionizing radiation are also cumulative, so that each time a person is exposed to radiation, the dose received has to be added to the amount of radiation already received. The total number of radiation-induced mutations is directly proportional to the total gonadal dose.

Unfortunately, in humans there is no easy way to demonstrate genetic damage caused by mutagens. Several agencies throughout the world are responsible for defining what is referred to as the maximum permissible dose of radiation. In the United Kingdom, the Radiation Protection Division of the Health Protection Agency advises that occupational exposure should not exceed 15 mSv in a year. To put this into perspective, 1 mSv is roughly 50 times the dose received in a single chest x-ray and 100 times the dose incurred when flying from the United Kingdom to Spain in a jet aircraft!

There is no doubting the potential dangers, both somatic and germline, of exposure to ionizing radiation. In the case of medical radiology, the dose of radiation resulting from a particular procedure has to be weighed against the ultimate beneficial effect to the patient. In the case of occupational exposure to radiation, the answer lies in defining the risks and introducing and enforcing adequate legislation. With regard to the dangers from fallout from nuclear accidents and explosions, the solution would seem obvious.

### Chemical Mutagens

In humans, chemical mutagenesis may be more important than radiation in producing genetic damage. Experiments have shown that certain chemicals, such as mustard gas, formaldehyde, benzene, some basic dyes, and food additives, are mutagenic in animals. Exposure to environmental chemicals

**Table 2.7** DNA Repair Pathways, Genes, and Associated Disorders

Type of DNA Repair	Mechanism	Genes	Disorders
Base excision repair (BER)	Removal of abnormal bases	<i>MYH</i>	Colorectal cancer
Nucleotide excision repair (NER)	Removal of thymine dimers and large chemical adducts	<i>XP</i>	Xeroderma pigmentosum
Postreplication repair	Removal of double-strand breaks by homologous recombination or nonhomologous end-joining	<i>NBS</i> <i>BLM</i> <i>BRCA1/2</i>	Nijmegen breakage syndrome Bloom syndrome Breast cancer
Mismatch repair (MMR)	Corrects mismatched bases caused by mistakes in DNA replication	<i>MSH</i> and <i>MLH</i>	Colorectal cancer (HNPCC)

HNPCC, Hereditary nonpolyposis colorectal cancer.

may result in the formation of DNA adducts, chromosome breaks, or aneuploidy. Consequently all new pharmaceutical products are subject to a battery of mutagenicity tests that include both *in vitro* and *in vivo* studies in animals.

### DNA Repair

The occurrence of mutations in DNA, if left unrepaired, would have serious consequences for both the individual and subsequent generations. The stability of DNA is dependent upon continuous **DNA repair** by a number of different mechanisms (Table 2.7). Some types of DNA damage can be repaired directly. Examples include the dealkylation of O<sup>6</sup>-alkyl guanine or the removal of thymine dimers by photoreactivation in bacteria. The majority of DNA repair mechanisms involve cleavage of the DNA strand by an endonuclease, removal of the damaged region by an exonuclease, insertion of new bases by the enzyme DNA polymerase, and sealing of the break by DNA ligase.

**Nucleotide excision repair** removes thymine dimers and large chemical adducts. It is a complex process involving more than 30 proteins that remove fragments of approximately 30 nucleotides. Mutations in at least eight of the genes encoding these proteins can cause xeroderma pigmentosum (p. 252), characterized by extreme sensitivity to ultraviolet light and a high frequency of skin cancer. A different set of repair enzymes is used to excise single abnormal bases (**base excision repair**), with mutations in the gene encoding the DNA glycosylase *MYH* having recently been shown to cause an autosomal recessive form of colorectal cancer (p. 191).

Naturally occurring reactive oxygen species and ionizing radiation induce breakage of DNA strands. Double-strand breaks result in chromosome breaks that can be lethal if not repaired. **Postreplication repair** is required to correct double-strand breaks and usually involves homologous recombination with a sister DNA molecule. Human genes involved in this pathway include *NBS*, *BLM*, and *BRCA1/2*, mutated in Nijmegen breakage syndrome, Bloom syndrome (p. 250), and hereditary breast cancer (p. 192), respectively. Alternatively, the broken ends may be rejoined by nonhomologous end-joining, which is an error-prone pathway.

**Mismatch repair (MMR)** corrects mismatched bases introduced during DNA replication. Cells defective in MMR have very high mutation rates (up to 1000 times higher than normal). Mutations in at least six different MMR genes cause hereditary nonpolyposis colorectal cancer (HNPCC; see p. 222).

Although DNA repair pathways have evolved to correct DNA damage and hence protect the cell from the deleterious consequences of mutations, some mutations arise from the

cell's attempts to tolerate damage. One example is **translesion DNA synthesis**, in which the DNA replication machinery bypasses sites of DNA damage, allowing normal DNA replication and gene expression to proceed downstream. Human disease may also be caused by defective cellular responses to DNA damage. Cells have complex signaling pathways that allow cell-cycle arrest to provide increased time for DNA repair. If the DNA damage is irreparable, the cell may initiate programmed cell death (**apoptosis**). The ATM protein is involved in sensing DNA damage and has been described as the 'guardian of the genome'. Mutations in the *ATM* gene cause ataxia telangiectasia (see p. 173), characterized by hypersensitivity to radiation and a high risk of cancer.

### FURTHER READING

- Alberts, B., Johnson, A., Lewis, J., et al., 2014. Molecular biology of the cell, 6th ed. Garland, London.  
*Very accessible, well written, and lavishly illustrated comprehensive text of molecular biology with >170 narrated movies.*
- Dawkins, R., 1989. The selfish gene, 3rd ed. Oxford University Press, Oxford.  
*An interesting, controversial concept.*
- Fire, A., Xu, S., Montgomery, M.K., et al., 1998. Potent and specific genetic interference by double-stranded RNA in *Caenorhabditis elegans*. *Nature* 391, 806–811.  
*Landmark paper describing the discovery of RNAi.*
- Lewin, B., 2014. Genes XI, 11th ed. Oxford University Press, Oxford.  
*The tenth edition of this excellent textbook of molecular biology with color diagrams and figures. Hard to improve upon.*
- Mettler, F.A., Upton, A.C., 2008. Medical effects of ionising radiation, 3rd ed. Saunders, Philadelphia.  
*Good overview of all aspects of the medical consequences of ionizing radiation.*
- Schull, W.J., Neel, J.V., 1958. Radiation and the sex ratio in man. Sex ratio among children of survivors of atomic bombings suggests induced sex-linked lethal mutations. *Science* 228, 434–438.  
*The original report of possible evidence of the effects of atomic radiation.*
- Strachan, T., Read, A.P., 2010. Human molecular genetics, 4th ed. Garland Science, London.  
*An excellent, comprehensive textbook of molecular aspects of human genetics as it relates to inherited disease in humans.*
- Turner, J.E., 1995. Atoms, radiation and radiation protection. John Wiley, Chichester, UK.  
*Basis of the physics of radiation, applications, and harmful effects.*
- Watson, J.D., Crick, F.H.C., 1953. Molecular structure of nucleic acids—a structure for deoxyribose nucleic acid. *Nature* 171, 737–738.  
*The concepts in this paper, presented in just over one page, resulted in the authors receiving the Nobel Prize!*



## ELEMENTS

- 1 Genetic information is stored in DNA (deoxyribonucleic acid) as a linear sequence of two types of nucleotide, the purines (adenine [A] and guanine [G]) and the pyrimidines (cytosine [C] and thymine [T]), linked by a sugar-phosphate backbone.
- 2 A molecule of DNA consists of two antiparallel strands held in a double helix by hydrogen bonds between the complementary G–C and A–T base pairs.
- 3 DNA replication has multiple sites of origin and is semiconservative, each strand acting as a template for synthesis of a complementary strand.
- 4 Genes coding for proteins in higher organisms (eukaryotes) consist of coding (exons) and noncoding (introns) sections.
- 5 Transcription is the synthesis of a single-stranded complementary copy of one strand of a gene that is known as messenger RNA (mRNA). RNA (ribonucleic acid) differs from DNA in containing the sugar ribose and the base uracil instead of thymine.
- 6 mRNA is processed during transport from the nucleus to the cytoplasm, eliminating the noncoding sections. In the cytoplasm it becomes associated with the ribosomes, where translation (i.e., protein synthesis) occurs.
- 7 The genetic code is 'universal' and consists of triplets (codons) of nucleotides, each of which codes for an amino acid or termination of peptide chain synthesis. The code is degenerate, as all but two amino acids are specified by more than one codon.
- 8 The major control of gene expression is at the level of transcription by DNA regulatory sequences in the 5' flanking promoter region of structural genes in eukaryotes. General and specific transcription factors are also involved in the regulation of genes.
- 9 Mutations occur both spontaneously and as a result of exposure to mutagenic agents such as ionizing radiation. Mutations are continuously corrected by DNA repair enzymes.

# Chapter 3

## Chromosomes and Cell Division

*Let us not take it for granted that life exists more fully in what is commonly thought big than in what is commonly thought small.*

VIRGINIA WOOLF

At the molecular or submicroscopic level, DNA can be regarded as the basic template that provides a blueprint for the formation and maintenance of an organism. DNA is packaged into **chromosomes** and at a very simple level these can be considered as being made up of tightly coiled long chains of genes. Unlike DNA, chromosomes can be visualized during cell division using a light microscope, under which they appear as threadlike structures or ‘colored bodies’. The word *chromosome* is derived from the Greek *chroma* (= color) and *soma* (= body).

Chromosomes are the factors that distinguish one species from another and that enable the transmission of genetic information from one generation to the next. Their behavior at somatic cell division in mitosis provides a means of ensuring that each daughter cell retains its own complete genetic complement. Similarly, their behavior during gamete formation in meiosis enables each mature ovum and sperm to contain a unique single set of parental genes. Chromosomes are quite literally the vehicles that facilitate reproduction and the maintenance of a species.

The study of chromosomes and cell division is referred to as **cytogenetics**. Before the 1950s it was thought, incorrectly, that each human cell contained 48 chromosomes and that human sex was determined by the number of X chromosomes present at conception. Following the development in 1956 of more reliable techniques for studying human chromosomes, it was realized that the correct chromosome number in humans is 46 (p. 3) and that maleness is determined by the presence of a Y chromosome regardless of the number of X chromosomes present in each cell. It was also realized that abnormalities of chromosome number and structure could seriously disrupt normal growth and development.

Table 3.1 highlights the methodological developments that have taken place during the past 5 decades that underpin our current knowledge of human cytogenetics.

### Human Chromosomes

#### Morphology

At the submicroscopic level, chromosomes consist of an extremely elaborate complex, made up of supercoils of DNA, which has been likened to the tightly coiled network of wiring seen in a solenoid (p. 11). Under the electron microscope chromosomes can be seen to have a rounded and rather irregular morphology (Figure 3.1). However, most of our knowledge

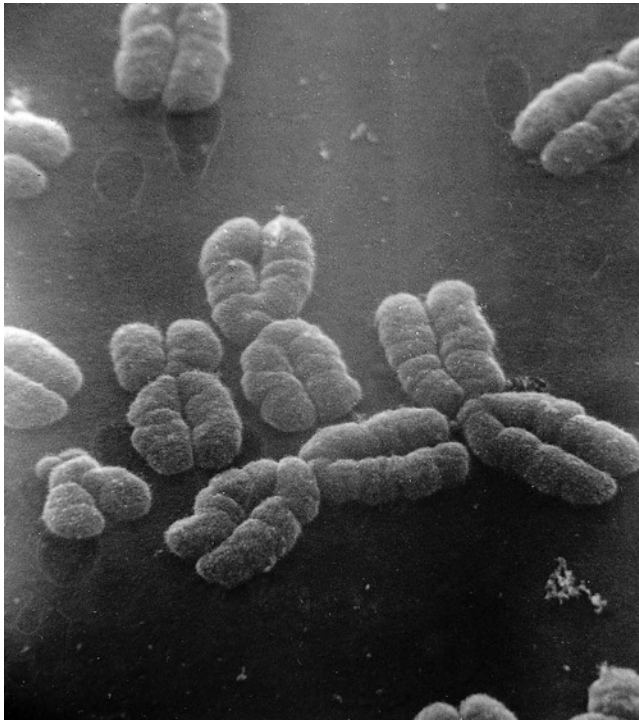
of chromosome structure has been gained using light microscopy. Special stains selectively taken up by DNA have enabled each individual chromosome to be identified. These are best seen during cell division, when the chromosomes are maximally contracted and the constituent genes can no longer be transcribed.

At this time each chromosome can be seen to consist of two identical strands known as **chromatids**, or **sister chromatids**, which are the result of DNA replication having taken place during the S (synthesis) phase of the cell cycle (p. 30). These sister chromatids can be seen to be joined at a primary constriction known as the **centromere**. Centromeres consist of several hundred kilobases of repetitive DNA and are responsible for the movement of chromosomes at cell division. Each centromere divides the chromosome into short and long arms, designated p (= petite) and q ('g' = grande), respectively.

**Table 3.1** Development of Methodologies for Cytogenetics

Decade	Development	Examples of Application
1950–1960s	Reliable methods for chromosome preparations	Chromosome number determined to be 46 (1956) and Philadelphia chromosome identified as t(9;22) (1960)
1970s	Giemsa chromosome banding	Mapping of <i>RBI</i> gene to chromosome 13q14 by identification of deleted chromosomal region in patients with retinoblastoma (1976)
1990s	Fluorescent in-situ hybridization (FISH)	Interphase FISH for rapid detection of Down syndrome (1994) Spectral karyotyping for whole genome chromosome analysis (1996)
2000s	Array CGH	Analysis of constitutional rearrangements; e.g., identification of ~5 Mb deletion in a patient with CHARGE syndrome that led to identification of the gene (2004)

CHARGE, coloboma of the eye, heart defects, atresia of the choanae, retardation of growth and/or development, genital and/or urinary abnormalities, and ear abnormalities and deafness.



**FIGURE 3.1** Electron micrograph of human chromosomes showing the centromeres and well-defined chromatids. (Courtesy Dr. Christine Harrison. Reproduced from Harrison et al 1983 *Cytogenet Cell Genet* 35: 21–27; with permission of the publisher, S. Karger, Basel.)

The tip of each chromosome arm is known as the **telomere**. Telomeres play a crucial role in sealing the ends of chromosomes and maintaining their structural integrity. Telomeres have been highly conserved throughout evolution and in humans they consist of many tandem repeats of a TTAGGG sequence. During DNA replication, an enzyme known as **telomerase** replaces the 5' end of the long strand, which would otherwise become progressively shorter until a critical length was reached when the cell could no longer divide and thus became senescent. This is in fact part of the normal cellular aging process, with most cells being unable to undergo more than 50 to 60 divisions. However, in some tumors, increased telomerase activity has been implicated as a cause of abnormally prolonged cell survival.

Morphologically chromosomes are classified according to the position of the centromere. If this is located centrally, the chromosome is **metacentric**, if terminal it is **acrocentric**, and if the centromere is in an intermediate position the chromosome is **submetacentric** (Figure 3.2). Acrocentric chromosomes sometimes have stalk-like appendages called **satellites** that form the nucleolus of the resting interphase cell and contain multiple repeat copies of the genes for ribosomal RNA.

### Classification

Individual chromosomes differ not only in the position of the centromere, but also in their overall length. Based on the three parameters of length, position of the centromere, and the presence or absence of satellites, early pioneers of cytogenetics were able to identify most individual chromosomes, or at least subdivide them into groups labeled A to G on the basis of overall morphology (A, 1–3; B, 4–5; C, 6–12 X; D, 13–15; E,

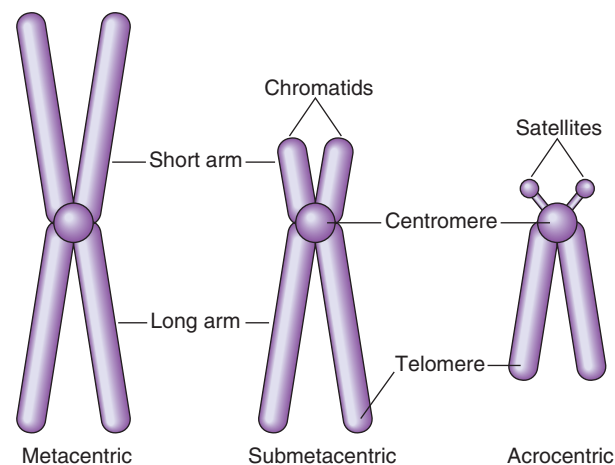
16–18; F, 19–20; G, 21–22 1 Y). In humans the normal cell nucleus contains 46 chromosomes, made up of 22 pairs of **autosomes** and a single pair of sex chromosomes—XX in the female and XY in the male. One member of each of these pairs is derived from each parent. Somatic cells are said to have a **diploid** complement of 46 chromosomes, whereas gametes (ova and sperm) have a **haploid** complement of 23 chromosomes. Members of a pair of chromosomes are known as **homologs**.

The development of chromosome banding (p. 26) enabled very precise recognition of individual chromosomes and the detection of subtle chromosome abnormalities. This technique also revealed that **chromatin**, the combination of DNA and histone proteins that comprise chromosomes, exists in two main forms. **Euchromatin** stains lightly and consists of genes that are actively expressed. In contrast, **heterochromatin** stains darkly and is made up largely of inactive, unexpressed, repetitive DNA.

### The Sex Chromosomes

The X and Y chromosomes are known as the sex chromosomes because of their crucial role in sex determination. The X chromosome was originally labeled as such because of uncertainty as to its function when it was realized that in some insects this chromosome is present in some gametes but not in others. In these insects the male has only one sex chromosome (X), whereas the female has two (XX). In humans, and in most mammals, both the male and the female have two sex chromosomes—XX in the female and XY in the male. The Y chromosome is much smaller than the X and carries only a few genes of functional importance, most notably the testis-determining factor, known as **SRY** (p. 109). Other genes on the Y chromosome are known to be important in maintaining spermatogenesis.

In the female each ovum carries an X chromosome, whereas in the male each sperm carries either an X or a Y chromosome. As there is a roughly equal chance of either an X-bearing sperm or a Y-bearing sperm fertilizing an ovum, the numbers of male and female conceptions are approximately equal (Figure 3.3). In fact, slightly more male babies are born than females, although during childhood and adult life the sex ratio evens out at 1 : 1.



**FIGURE 3.2** Morphologically chromosomes are described as metacentric, submetacentric, or acrocentric, depending on the position of the centromere.

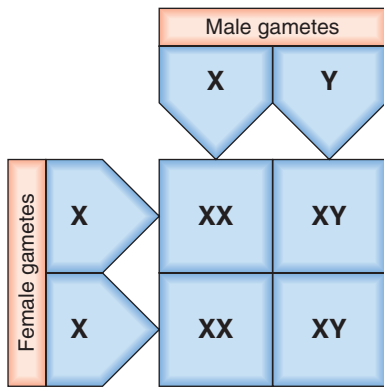


FIGURE 3.3 Punnett square showing sex chromosome combinations for male and female gametes.

The process of sex determination is considered in detail later (p. 123).

### Methods of Chromosome Analysis

It was generally believed that each cell contained 48 chromosomes until 1956, when Tjio and Levan correctly concluded on the basis of their studies that the normal human somatic cell contains only 46 chromosomes (p. 3). The methods they used, with certain modifications, are now universally employed in cytogenetic laboratories to analyze the chromosome

constitution of an individual, which is known as a **karyotype**. This term is also used to describe a photomicrograph of an individual's chromosomes, arranged in a standard manner.

### Chromosome Preparation

Any tissue with living nucleated cells that undergo division can be used for studying human chromosomes. Most commonly circulating lymphocytes from peripheral blood are used, although samples for chromosomal analysis can be prepared relatively easily using skin, bone marrow, chorionic villi, or cells from amniotic fluid (amniocytes).

In the case of peripheral (venous) blood, a sample is added to a small volume of nutrient medium containing phytohemagglutinin, which stimulates T lymphocytes to divide. The cells are cultured under sterile conditions at 37°C for about 3 days, during which they divide, and colchicine is then added to each culture. This drug has the extremely useful property of preventing formation of the spindle, thereby arresting cell division during metaphase, the time when the chromosomes are maximally condensed and therefore most visible. Hypotonic saline is then added, which causes the blood cells to lyse and results in spreading of the chromosomes, which are then fixed, mounted on a slide and stained ready for analysis (Figure 3.4).

### Chromosome Banding

Several different staining methods can be used to identify individual chromosomes but G (**Giemsa**) banding is used most commonly. The chromosomes are treated with trypsin, which

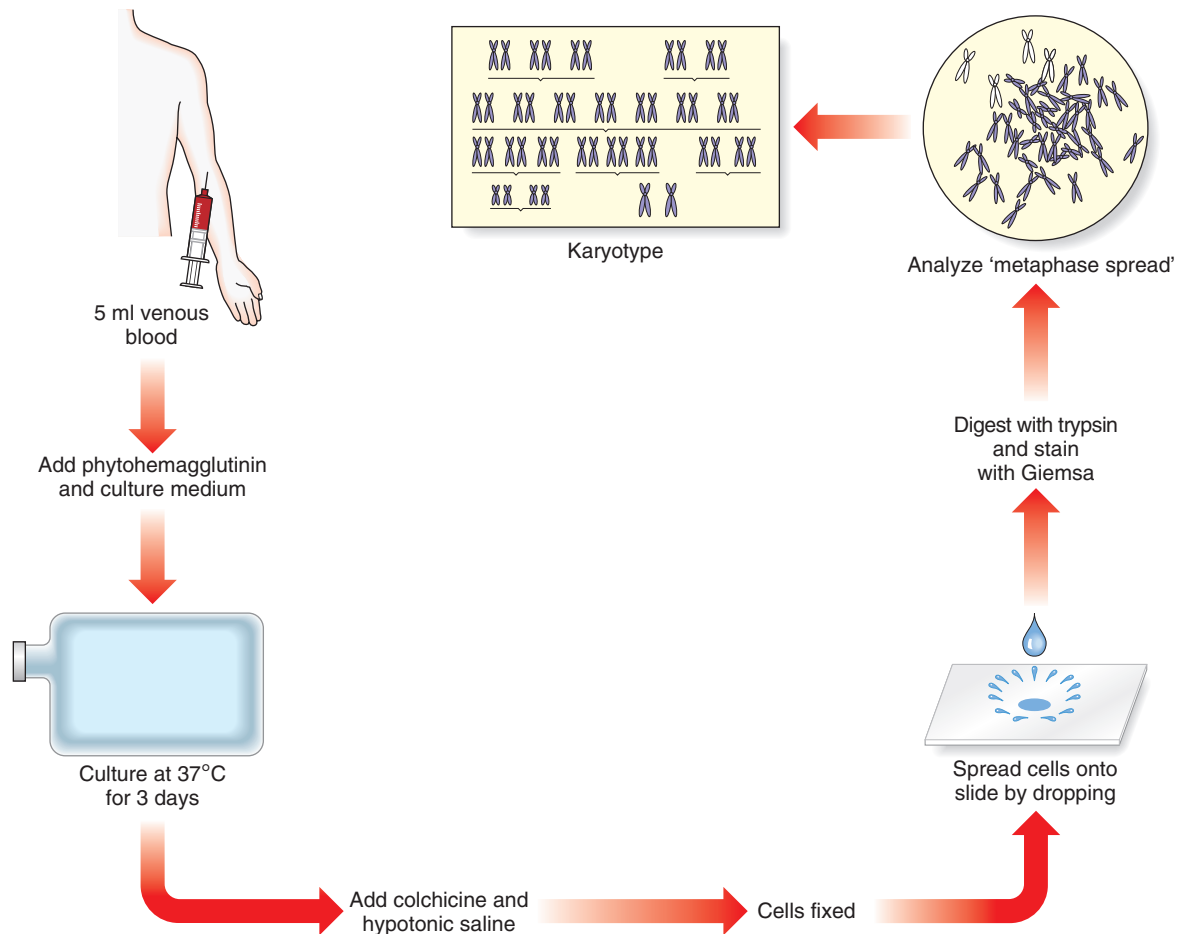


FIGURE 3.4 Preparation of a karyotype.

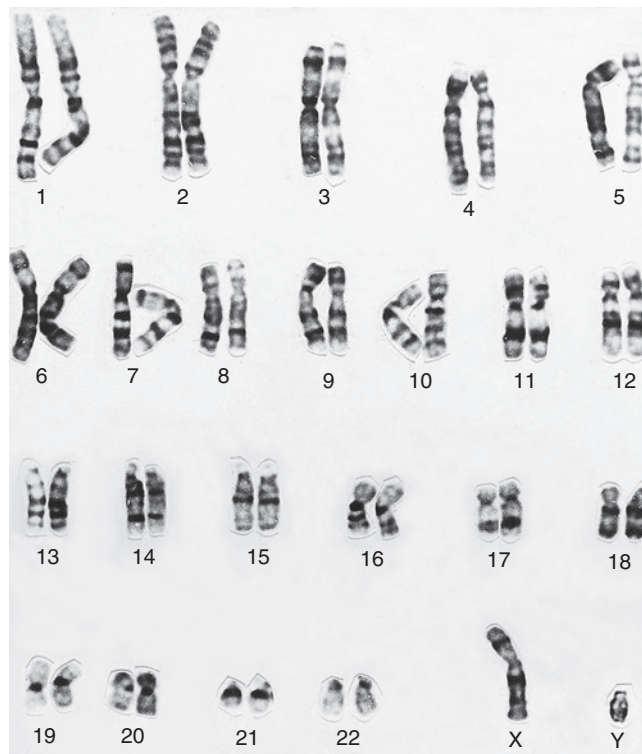


FIGURE 3.5 A normal G-banded male karyotype.

denatures their protein content, and then stained with a DNA-binding dye—also known as ‘Giemsa’—that gives each chromosome a characteristic and reproducible pattern of light and dark bands (Figure 3.5).

G banding generally provides high-quality chromosome analysis with approximately 400 to 500 bands per haploid set. Each of these bands corresponds on average to approximately 6000 to 8000 kilobases (kb) (i.e., 6 to 8 megabases [mb]) of DNA. High-resolution banding of the chromosomes at an earlier stage of mitosis, such as prophase or prometaphase, provides greater sensitivity with up to 800 bands per haploid set, but is much more demanding technically. This involves first inhibiting cell division with an agent such as methotrexate or thymidine. Folic acid or deoxycytidine is added to the culture medium, releasing the cells into mitosis. Colchicine is then added at a specific time interval, when a higher proportion of cells will be in prometaphase and the chromosomes will not be fully contracted, giving a more detailed banding pattern.

### Karyotype Analysis

The next stage in chromosome analysis involves first counting the number of chromosomes present in a specified number of cells, sometimes referred to as **metaphase spreads**, followed by careful analysis of the banding pattern of each individual chromosome in selected cells.

The banding pattern of each chromosome is specific and can be shown in the form of a stylized ideal karyotype known as an **idiogram** (Figure 3.6). The cytogeneticist analyzes each pair of homologous chromosomes, either directly by looking down the microscope or using an image capture system to photograph the chromosomes and arrange them in the form of a karyogram (Figure 3.7).

## Molecular Cytogenetics

### Fluorescent In-Situ Hybridization

This diagnostic tool combines conventional cytogenetics with molecular genetic technology. It is based on the unique ability of a portion of single-stranded DNA (i.e., a probe) to anneal with its complementary target sequence on a metaphase chromosome, interphase nucleus or extended chromatin fiber. In **fluorescent in-situ hybridization (FISH)**, the DNA probe is labeled with a fluorochrome which, after hybridization with the patient’s sample, allows the region where hybridization has occurred to be visualized using a fluorescence microscope. FISH has been widely used for clinical diagnostic purposes during the past 20 years and there are a number of different types of probes that may be employed.

### Different Types of FISH Probe

#### Centromeric Probes

These consist of repetitive DNA sequences found in and around the centromere of a specific chromosome. They were the original probes used for rapid interphase FISH diagnosis of the common aneuploidy syndromes (trisomies 13, 18, 21; see p. 236) from a prenatal diagnostic sample of chorionic villi until it was superseded by quantitative fluorescent polymerase chain reaction.

#### Chromosome-Specific Unique-Sequence Probes

These are specific for a particular single locus which can be used to identify submicroscopic deletions and duplications (Figure 3.8) causing **microdeletion** syndromes (described in

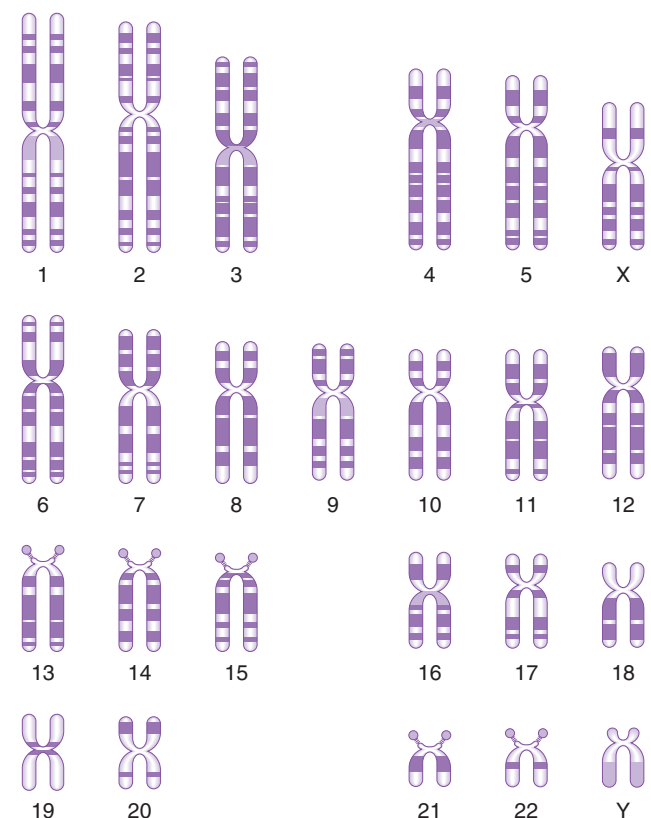


FIGURE 3.6 An idiogram showing the banding patterns of individual chromosomes as revealed by fluorescent and Giemsa staining.

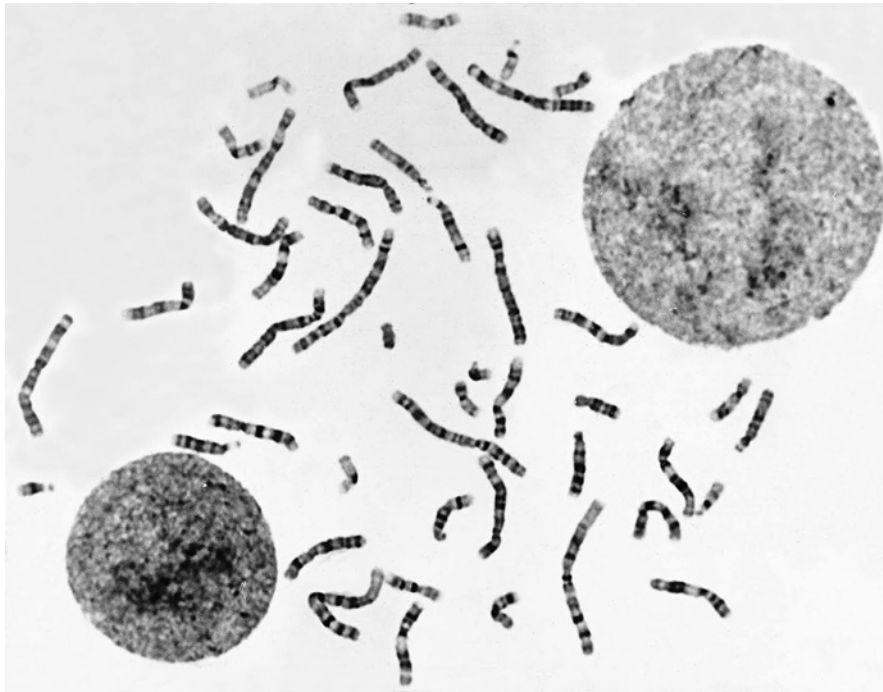


FIGURE 3.7 A G-banded metaphase spread. (Courtesy Mr. A. Wilkinson, Cytogenetics Unit, City Hospital, Nottingham, UK.)

Chapter 17). Another application is the use of an interphase FISH probe to identify *HER2* overexpression in breast tumors to identify patients likely to benefit from Herceptin treatment.

#### Whole-Chromosome Paint Probes

These consist of a cocktail of probes obtained from different parts of a particular chromosome. When this mixture of probes

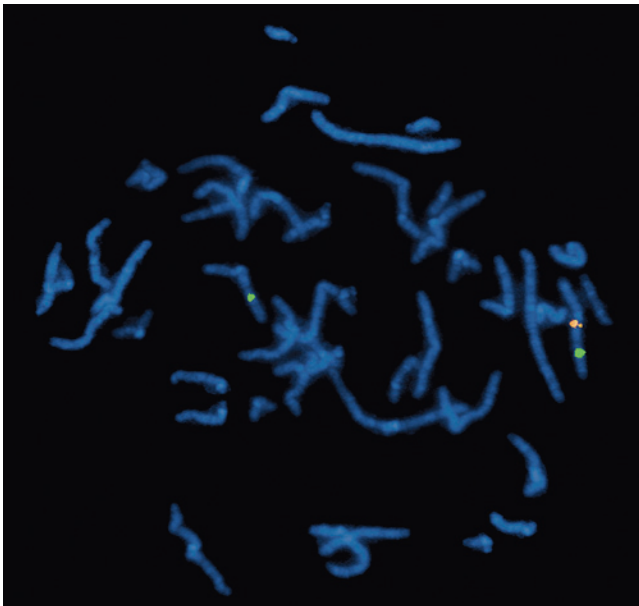


FIGURE 3.8 Metaphase image of Williams (*ELN*) region probe (Vysis), chromosome band 7q11.23, showing the deletion associated with Williams syndrome. The normal chromosome has signals for the control probe (green) and the *ELN* gene probe (orange), but the deleted chromosome shows only the control probe signal. (Courtesy Catherine Delmege, Bristol Genetics Laboratory, Southmead Hospital, Bristol, UK.)

is used together in a single hybridization, the entire relevant chromosome fluoresces (i.e., is 'painted'). Chromosome painting is useful for characterizing complex rearrangements, such as subtle translocations (Figure 3.9), and for identifying the origin of additional chromosome material, such as small supernumerary markers or rings.

#### Chromosome Nomenclature

By convention each chromosome arm is divided into regions and each region is subdivided into bands, numbering always

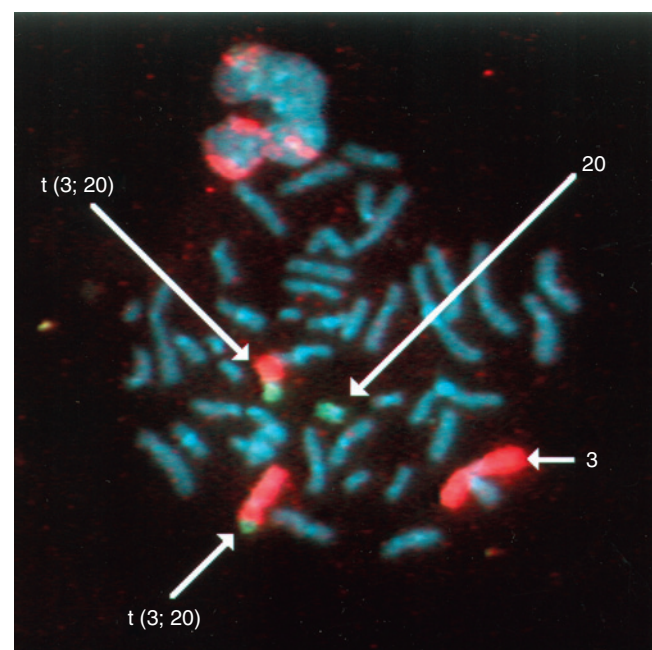
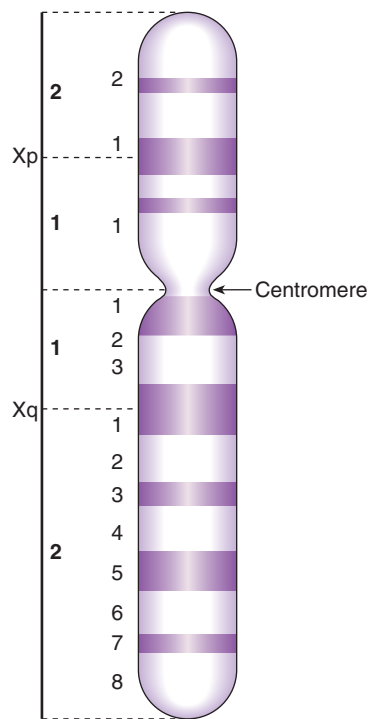


FIGURE 3.9 Chromosome painting showing a reciprocal translocation involving chromosomes 3 (red) and 20 (green).



**FIGURE 3.10** X chromosome showing the short and long arms each subdivided into regions and bands.

from the centromere outwards (Figure 3.10). A given point on a chromosome is designated by the chromosome number, the arm (p or q), the region, and the band (e.g., 15q12). Sometimes the word *region* is omitted, so that 15q12 would be referred to simply as band 12 on the long arm of chromosome 15.

A shorthand notation system exists for the description of chromosome abnormalities (Table 3.2). Normal male and female karyotypes are depicted as 46,XY and 46,XX, respectively. A male with Down syndrome as a result of trisomy 21 would be represented as 47,XY,+21, whereas a female with a deletion of the short arm of one number 5 chromosome (cri du chat syndrome; see p. 243) would be represented as

**Table 3.2** Symbols Used in Describing a Karyotype

Term	Explanation	Example
p	Short arm	
q	Long arm	
cen	Centromere	
del	Deletion	46,XX,del(1)(q21)
dup	Duplication	46,XY,dup(13)(q14)
fra	Fragile site	
i	Isochromosome	46,X,i(Xq)
inv	Inversion	46,XX,inv(9)(p12q12)
ish	In-situ hybridization	
r	Ring	46,XX,r(21)
t	Translocation	46,XY,t(2;4)(q21;q21)
ter	Terminal or end	Tip of arm; e.g., pter or qter
/	Mosaicism	46,XY/47,XXY
+ or -	Sometimes used after a chromosome arm in text to indicate gain or loss of part of that chromosome	46,XX,5p-

46,XX,del(5p). A chromosome report reading 46,XY,t(2;4)(p23;q25) would indicate a male with a reciprocal translocation involving the short arm of chromosome 2 at region 2 band 3 and the long arm of chromosome 4 at region 2 band 5.

## Cell Division

### Mitosis

At conception the human zygote consists of a single cell. This undergoes rapid division, leading ultimately to the mature human adult consisting of approximately  $1 \times 10^{14}$  cells in total. In most organs and tissues, such as bone marrow and skin, cells continue to divide throughout life. This process of somatic cell division, during which the nucleus also divides, is known as **mitosis**. During mitosis each chromosome divides into two daughter chromosomes, one of which segregates into each daughter cell. Consequently, the number of chromosomes per nucleus remains unchanged.

Prior to a cell entering mitosis, each chromosome consists of two identical sister chromatids as a result of DNA replication having taken place during the S phase of the cell cycle (p. 30). Mitosis is the process whereby each of these pairs of chromatids separates and disperses into separate daughter cells.

Mitosis is a continuous process that usually lasts 1 to 2 hours, but for descriptive purposes it is convenient to distinguish five distinct stages. These are prophase, prometaphase, metaphase, anaphase, and telophase (Figure 3.11).

### Prophase

During the initial stage of **prophase**, the chromosomes condense and the mitotic spindle begins to form. Two **centrioles** form in each cell, from which **microtubules** radiate as the centrioles move toward opposite poles of the cell.

### Prometaphase

During **prometaphase** the nuclear membrane begins to disintegrate, allowing the chromosomes to spread around the cell. Each chromosome becomes attached at its centromere to a microtubule of the mitotic spindle.

### Metaphase

In **metaphase** the chromosomes become aligned along the equatorial plane or plate of the cell, where each chromosome is attached to the centriole by a microtubule forming the mature spindle. At this point the chromosomes are maximally contracted and, therefore, most easily visible. Each chromosome resembles the letter X in shape, as the chromatids of each chromosome have separated longitudinally but remain attached at the centromere, which has not yet undergone division.

### Anaphase

In **anaphase** the centromere of each chromosome divides longitudinally and the two daughter chromatids separate to opposite poles of the cell.

### Telophase

By **telophase** the chromatids, which are now independent chromosomes consisting of a single double helix, have separated completely and the two groups of daughter chromosomes each become enveloped in a new nuclear membrane. The cell cytoplasm also separates (cytokinesis), resulting in the formation of two new daughter cells, each of which contains a complete diploid chromosome complement.

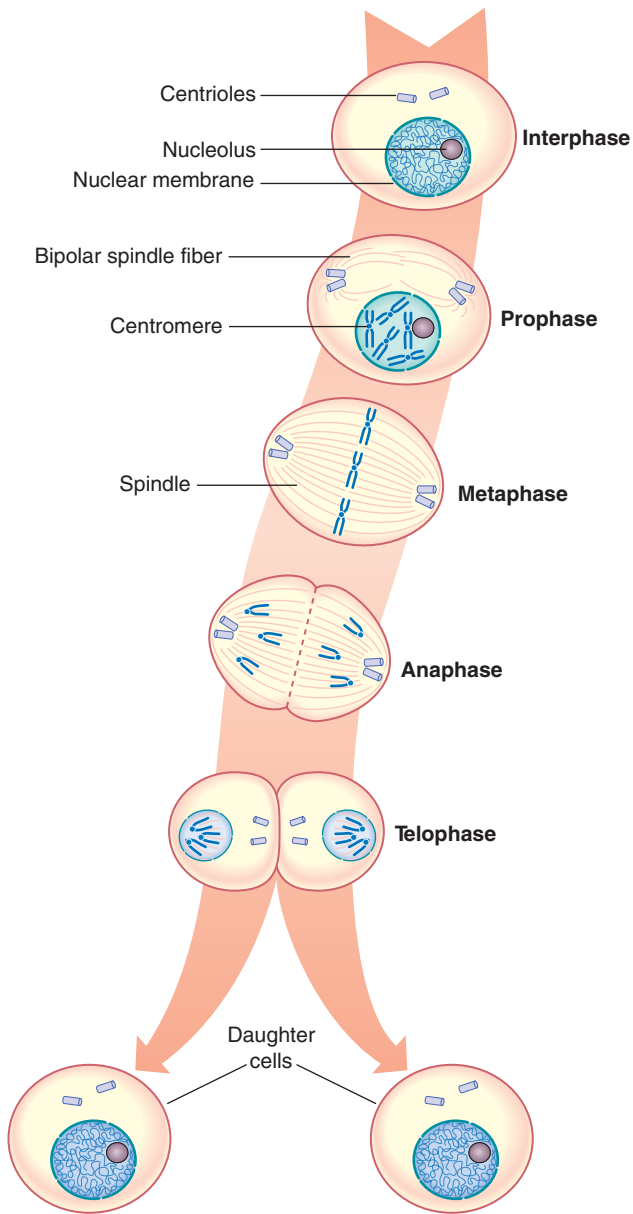


FIGURE 3.11 Stages of mitosis.

**The Cell Cycle**

The period between successive mitoses is known as the **interphase** of the cell cycle (Figure 3.12). In rapidly dividing cells this lasts for between 16 and 24 hours. Interphase commences with the G<sub>1</sub> (G = gap) phase during which the chromosomes become thin and extended. This phase of the cycle is very variable in length and is responsible for the variation in generation time between different cell populations. Cells that have stopped dividing, such as neurons, usually arrest in this phase and are said to have entered a noncyclic stage known as G<sub>0</sub>.

The G<sub>1</sub> phase is followed by the S phase (S = synthesis), when DNA replication occurs and the chromatin of each chromosome is replicated. This results in the formation of two chromatids, giving each chromosome its characteristic X-shaped configuration. The process of DNA replication commences at multiple points on a chromosome (p. 10).

Homologous pairs of chromosomes usually replicate in synchrony. However, one of the X chromosomes is always late

in replicating. This is the inactive X chromosome (p. 121) that forms the **sex chromatin** or so-called **Barr body**, which can be visualized during interphase in female somatic cells. This used to be the basis of a rather unsatisfactory means of sex determination based on analysis of cells obtained by scraping the buccal mucosa—a ‘buccal smear’.

Interphase is completed by a relatively short G<sub>2</sub> phase during which the chromosomes begin to condense in preparation for the next mitotic division.

**Meiosis**

**Meiosis** is the process of nuclear division that occurs during the final stage of gamete formation. Meiosis differs from mitosis in three fundamental ways:

1. Mitosis results in each daughter cell having a diploid chromosome complement (46). During meiosis the diploid count is halved so that each mature gamete receives a haploid complement of 23 chromosomes.
2. Mitosis takes place in somatic cells and during the early cell divisions in gamete formation. Meiosis occurs only at the final division of gamete maturation.
3. Mitosis occurs as a one-step process. Meiosis can be considered as two cell divisions known as meiosis I and meiosis II, each of which can be considered as having prophase, metaphase, anaphase, and telophase stages, as in mitosis (Figure 3.13).

**Meiosis I**

This is sometimes referred to as the reduction division, because it is during the first meiotic division that the chromosome number is halved.

*Prophase I*

Chromosomes enter this stage already split longitudinally into two chromatids joined at the centromere. Homologous chromosomes pair and, with the exception of the X and Y chromosomes in male meiosis, exchange of homologous segments

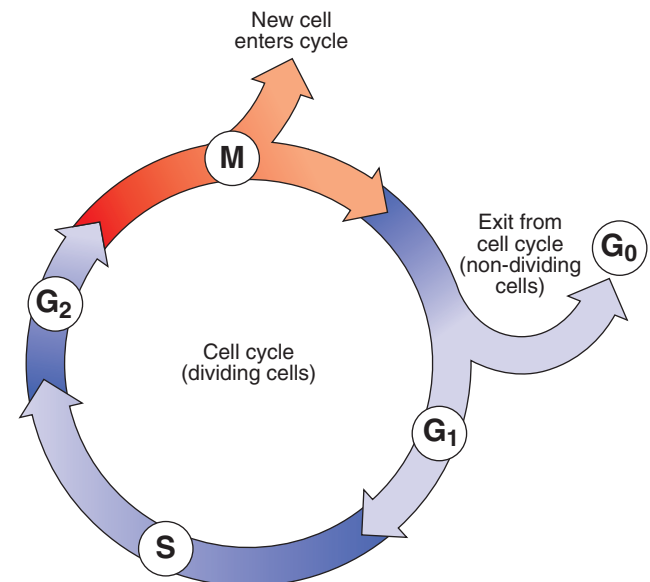


FIGURE 3.12 Stages of the cell cycle. G<sub>1</sub> and G<sub>2</sub> are the first and second ‘resting’ stages of interphase. S is the stage of DNA replication. M, mitosis.



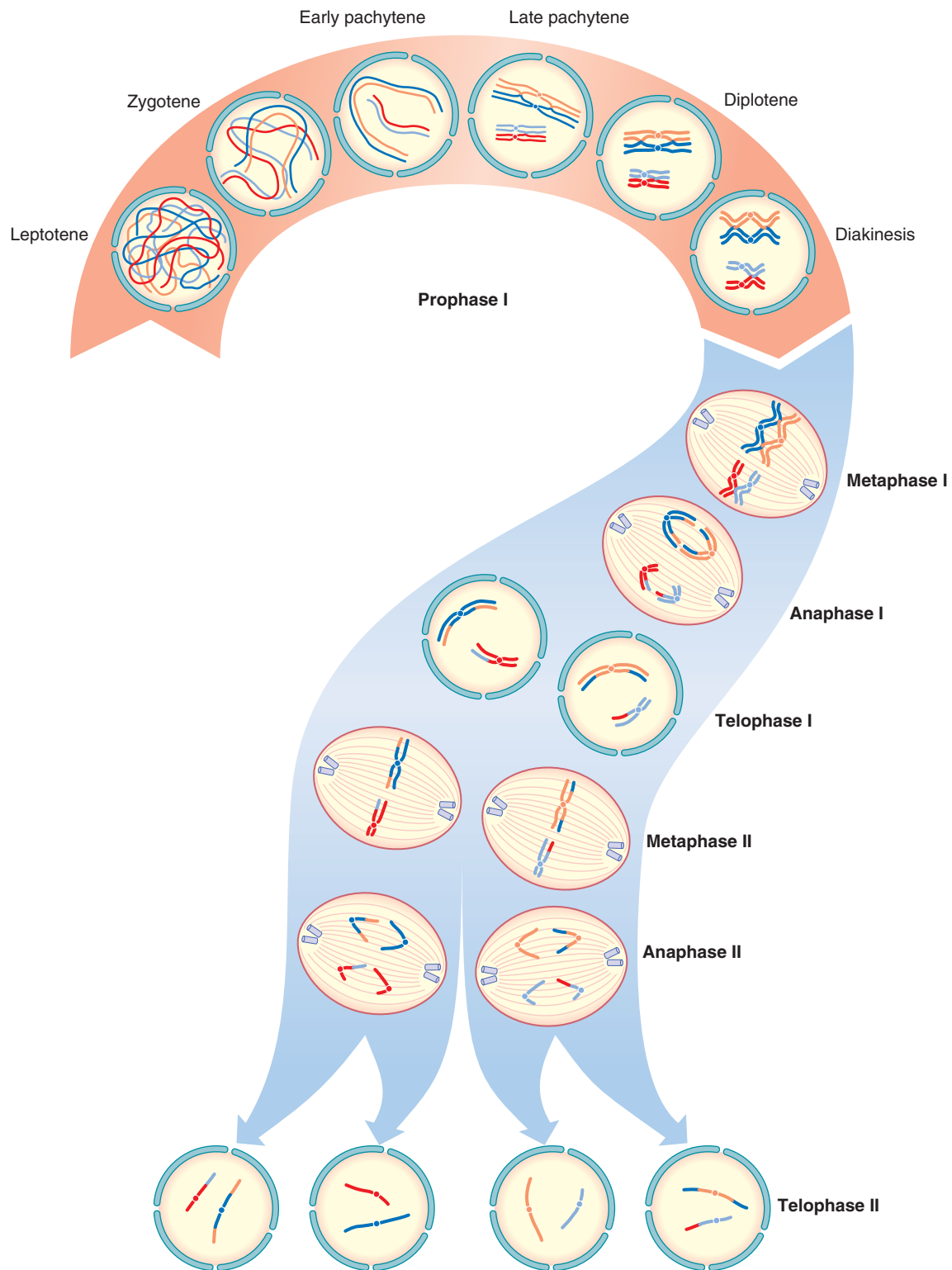


FIGURE 3.13 Stages of meiosis.

occurs between non-sister chromatids; that is, chromatids from each of the pair of homologous chromosomes. This exchange of homologous segments between chromatids occurs as a result of a process known as **crossing over** or **recombination**. The importance of crossing over in linkage analysis and risk calculation is considered later (pp. 89, 99).

During prophase I in the male, pairing occurs between homologous segments of the X and Y chromosomes at the tip

of their short arms, with this portion of each chromosome being known as the **pseudoautosomal region** (p. 74).

The prophase stage of meiosis I is relatively lengthy and can be subdivided into five stages.

**Leptotene.** The chromosomes become visible as they start to condense.

**Zygotene.** Homologous chromosomes align directly opposite each other, a process known as **synapsis**, and are held

together at several points along their length by filamentous structures known as synaptonemal complexes.

**Pachytene.** Each pair of homologous chromosomes, known as a bivalent, becomes tightly coiled. Crossing over occurs, during which homologous regions of DNA are exchanged between chromatids.

**Diplotene.** The homologous recombinant chromosomes now begin to separate but remain attached at the points where crossing over has occurred. These are known as chiasmata. On average, small, medium, and large chromosomes have one, two, and three chiasmata, respectively, giving an overall total of approximately 40 recombination events per meiosis per gamete.

**Diakinesis.** Separation of the homologous chromosome pairs proceeds as the chromosomes become maximally condensed.

### Metaphase I

The nuclear membrane disappears and the chromosomes become aligned on the equatorial plane of the cell where they have become attached to the spindle, as in metaphase of mitosis.

### Anaphase I

The chromosomes now separate to opposite poles of the cell as the spindle contracts.

### Telophase I

Each set of haploid chromosomes has now separated completely to opposite ends of the cell, which cleaves into two new daughter gametes, so-called **secondary spermatocytes** or **oocytes**.

## Meiosis II

This is essentially the same as an ordinary mitotic division. Each chromosome, which exists as a pair of chromatids, becomes aligned along the equatorial plane and then splits longitudinally, leading to the formation of two new daughter gametes, known as spermatids or ova.

## The Consequences of Meiosis

When considered in terms of reproduction and the maintenance of the species, meiosis achieves two major objectives. First, it facilitates halving of the diploid number of chromosomes so that each child receives half of its chromosome complement from each parent. Second, it provides an extraordinary potential for generating genetic diversity. This is achieved in two ways:

1. When the bivalents separate during prophase of meiosis I, they do so independently of one another. This is consistent with Mendel's third law (p. 3). Consequently each gamete receives a selection of parental chromosomes. The likelihood that any two gametes from an individual will contain exactly the same chromosomes is 1 in  $2^{23}$ , or approximately 1 in 8 million.
2. As a result of crossing over, each chromatid usually contains portions of DNA derived from both parental homologous chromosomes. A large chromosome typically consists of three or more segments of alternating parental origin. The ensuing probability that any two gametes will have an identical genome is therefore infinitesimally small. This dispersion of DNA into different gametes is sometimes referred to as **gene shuffling**.

## Gametogenesis

The process of gametogenesis shows fundamental differences in males and females (Table 3.3). These have quite distinct clinical consequences if errors occur.

### Oogenesis

Mature ova develop from oogonia by a complex series of intermediate steps. Oogonia themselves originate from primordial germ cells by a process involving 20 to 30 mitotic divisions that occur during the first few months of embryonic life. By the completion of embryogenesis at 3 months of intrauterine life, the oogonia have begun to mature into primary oocytes that start to undergo meiosis. At birth all of the primary oocytes have entered a phase of maturation arrest, known as **dictyotene**, in which they remain suspended until meiosis I is completed at the time of ovulation, when a single secondary oocyte is formed. This receives most of the cytoplasm. The other daughter cell from the first meiotic division consists largely of a nucleus and is known as a polar body. Meiosis II then commences, during which fertilization can occur. This second meiotic division results in the formation of a further polar body (Figure 3.14).

It is probable that the very lengthy interval between the onset of meiosis and its eventual completion, up to 50 years later, accounts for the well documented increased incidence of chromosome abnormalities in the offspring of older mothers (p. 35). The accumulating effects of 'wear and tear' on the primary oocyte during the dictyotene phase probably damage the cell's spindle formation and repair mechanisms, thereby predisposing to non-disjunction (p. 12).

### Spermatogenesis

In contrast, spermatogenesis is a relatively rapid process with an average duration of 60 to 65 days. At puberty spermatogonia, which will already have undergone approximately 30 mitotic divisions, begin to mature into primary spermatocytes which enter meiosis I and emerge as haploid secondary spermatocytes. These then undergo the second meiotic division to form spermatids, which in turn develop without any subsequent cell division into mature spermatozoa, of which 100 to 200 million are present in each ejaculate.

Spermatogenesis is a continuous process involving many mitotic divisions, possibly as many as 20 to 25 per annum, so that mature spermatozoa produced by a man of 50 years or older could well have undergone several hundred mitotic divisions. The observed paternal age effect for new dominant

**Table 3.3** Differences in Gametogenesis in Males and Females

	Males	Females
Commences	Puberty	Early embryonic life
Duration	60–65 days	10–50 years
Numbers of mitoses in gamete formation	30–500	20–30
Gamete production per meiosis	4 spermatids	1 ovum + 3 polar bodies
Gamete production per ejaculate	100–200 million	1 ovum per menstrual cycle

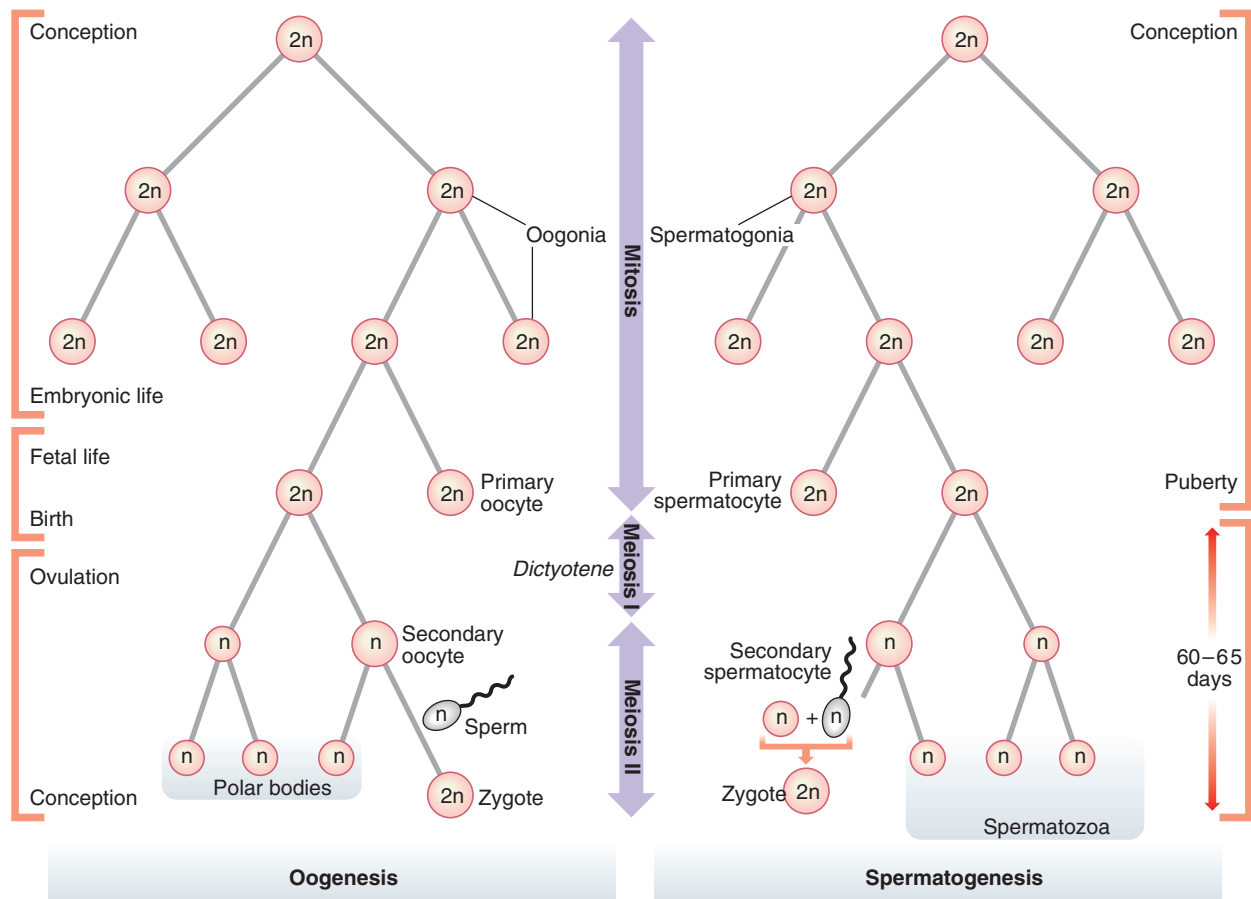


FIGURE 3.14 Stages of oogenesis and spermatogenesis.  $n$ , haploid number.

mutations (p. 69) is consistent with the concept that many mutations arise as a consequence of DNA copy errors occurring during mitosis.

## Chromosome Abnormalities

Specific disorders caused by chromosome abnormalities are considered in Chapter 17. In this section, discussion is restricted to a review of the different types of abnormality that may occur. These can be divided into numerical and structural, with a third category consisting of different chromosome constitutions in two or more cell lines (Box 3.1).

### Numerical Abnormalities

Numerical abnormalities involve the loss or gain of one or more chromosomes, referred to as **aneuploidy**, or the addition of one or more complete haploid complements, known as **polyploidy**. Loss of a single chromosome results in **monosomy**. Gain of one or two homologous chromosomes is referred to as **trisomy** or **tetrasomy**, respectively.

### Trisomy

The presence of an extra chromosome is referred to as **trisomy**. Most cases of Down syndrome are due to the presence of an additional number 21 chromosome; hence, Down syndrome is often known as trisomy 21. Other autosomal trisomies compatible with survival to term are Patau syndrome (trisomy 13) (p. 238) and Edwards syndrome (trisomy 18) (p. 238). Most other autosomal trisomies result in early pregnancy loss, with trisomy 16 being a particularly common finding in first-trimester

spontaneous miscarriages. The presence of an additional sex chromosome (X or Y) has only mild phenotypic effects (p. 123).

Trisomy 21 is usually caused by failure of separation of one of the pairs of homologous chromosomes during anaphase of

### Box 3.1 Types of Chromosome Abnormality

#### Numerical

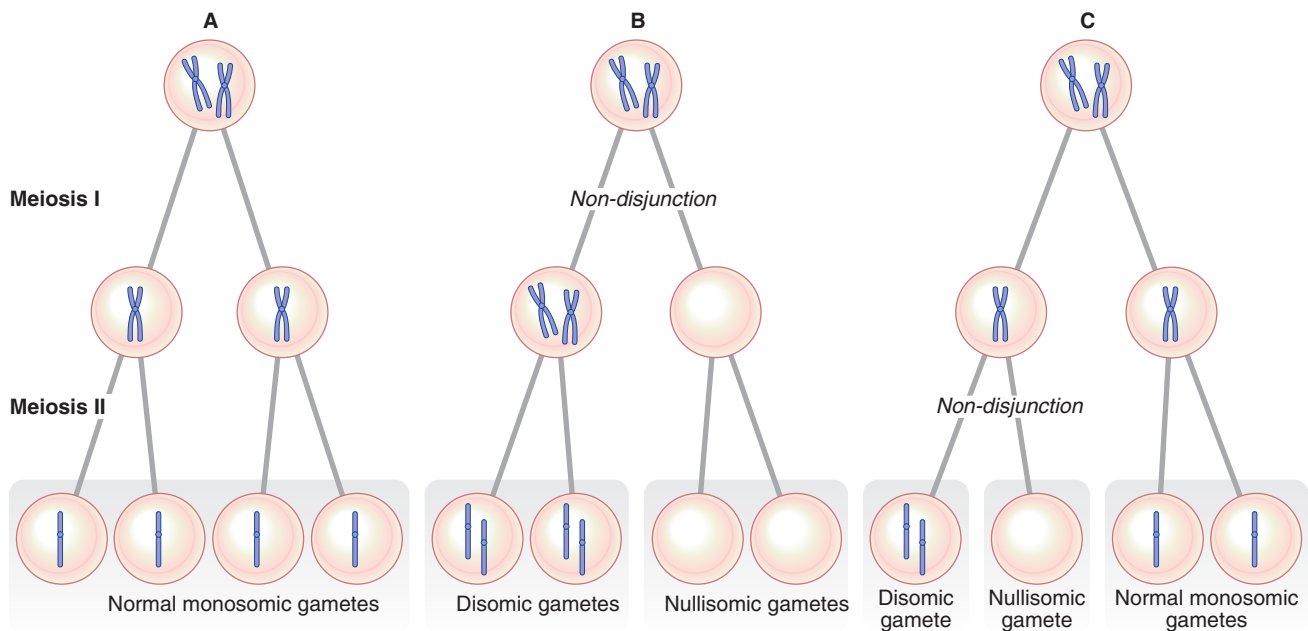
- Aneuploidy
- Monosomy
- Trisomy
- Tetrasomy
- Polyploidy
- Triploidy
- Tetraploidy

#### Structural

- Translocations
- Reciprocal
- Robertsonian
- Deletions
- Insertions
- Inversions
- Paracentric
- Pericentric
- Rings
- Isochromosomes

#### Different Cell Lines (Mixoploidy)

- Mosaicism
- Chimerism



**FIGURE 3.15** Segregation at meiosis of a single pair of chromosomes in **A**, normal meiosis, **B**, non-disjunction in meiosis I, and **C**, non-disjunction in meiosis II.

maternal meiosis I. This failure of the bivalent to separate is called **non-disjunction**. Less often, trisomy can be caused by non-disjunction occurring during meiosis II when a pair of sister chromatids fails to separate. Either way the gamete receives two homologous chromosomes (**disomy**); if subsequent fertilization occurs, a trisomic conceptus results (Figure 3.15).

### The Origin of Non-Disjunction

The consequences of non-disjunction in meiosis I and meiosis II differ in the chromosomes found in the gamete. An error in meiosis I leads to the gamete containing both homologs of one chromosome pair. In contrast, non-disjunction in meiosis II results in the gamete receiving two copies of one of the homologs of the chromosome pair. Studies using DNA markers have shown that most children with an autosomal trisomy have inherited their additional chromosome as a result of non-disjunction occurring during one of the maternal meiotic divisions (Table 3.4).

Non-disjunction can also occur during an early mitotic division in the developing zygote. This results in the presence of two or more different cell lines, a phenomenon known as **mosaicism** (p. 40).

### The Cause of Non-Disjunction

The cause of non-disjunction is uncertain. The most favored explanation is that of an aging effect on the primary oocyte, which can remain in a state of suspended inactivity for up to 50 years (p. 32). This is based on the well-documented association between advancing maternal age and increased incidence of Down syndrome in offspring (see Table 17.4; see p. 237). A maternal age effect has also been noted for trisomies 13 and 18.

It is not known how or why advancing maternal age predisposes to non-disjunction, although research has shown that absence of recombination in prophase of meiosis I predisposes to subsequent non-disjunction. This is not surprising, as the chiasmata that are formed after recombination are responsible for holding each pair of homologous chromosomes together until subsequent separation occurs in diakinesis. Thus failure of chiasmata formation could allow each pair of homologs to separate prematurely and then segregate randomly to daughter cells. In the female, however, recombination occurs before birth whereas the non-disjunctional event occurs any time between 15 and 50 years later. This suggests that at least two factors can be involved in causing non-disjunction: an absence of recombination between homologous chromosomes in the fetal ovary, and an abnormality in spindle formation many years later.

### Monosomy

The absence of a single chromosome is referred to as **monosomy**. Monosomy for an autosome is almost always incompatible with survival to term. Lack of contribution of an X or a Y chromosome results in a 45,X karyotype, which causes the condition known as Turner syndrome (p. 240).

As with trisomy, monosomy can result from non-disjunction in meiosis. If one gamete receives two copies of a homologous chromosome (**disomy**), the other corresponding daughter gamete will have no copy of the same chromosome (**nullisomy**). Monosomy can also be caused by loss of a chromosome as it

**Table 3.4** Parental Origin of Meiotic Error Leading to Aneuploidy

Chromosome Abnormality	Paternal (%)	Maternal (%)
Trisomy 13	15	85
Trisomy 18	10	90
Trisomy 21	5	95
45,X	80	20
47,XXX	5	95
47,XXY	45	55
47,XYY	100	0

moves to the pole of the cell during anaphase, an event known as **anaphase lag**.

### Polyploidy

Polyploid cells contain multiples of the haploid number of chromosomes such as 69, **triploidy**, or 92, **tetraploidy**. In humans, triploidy is found relatively often in material grown from spontaneous miscarriages, but survival beyond mid-pregnancy is rare. Only a few triploid live births have been described and all died soon after birth.

Triploidy can be caused by failure of a maturation meiotic division in an ovum or sperm, leading, for example, to retention of a polar body or to the formation of a diploid sperm. Alternatively it can be caused by fertilization of an ovum by two sperm: this is known as **dispermy**. When triploidy results from the presence of an additional set of paternal chromosomes, the placenta is usually swollen with what are known as hydatidiform changes (p. 121). In contrast, when triploidy results from an additional set of maternal chromosomes, the placenta is usually small. Triploidy usually results in early spontaneous miscarriage (Figure 3.16). The differences between triploidy due to an additional set of **paternal** chromosomes or **maternal** chromosomes provide evidence for important 'epigenetic' and 'parent of origin' effects with respect to the human genome. These are discussed in more detail in Chapter 6.

### Structural Abnormalities

Structural chromosome rearrangements result from chromosome breakage with subsequent reunion in a different configuration. They can be balanced or unbalanced. In balanced rearrangements the chromosome complement is complete, with no loss or gain of genetic material. Consequently, balanced rearrangements are generally harmless with the exception of rare cases in which one of the breakpoints damages an important functional gene. However, carriers of balanced rearrangements are often at risk of producing children with an unbalanced chromosomal complement.

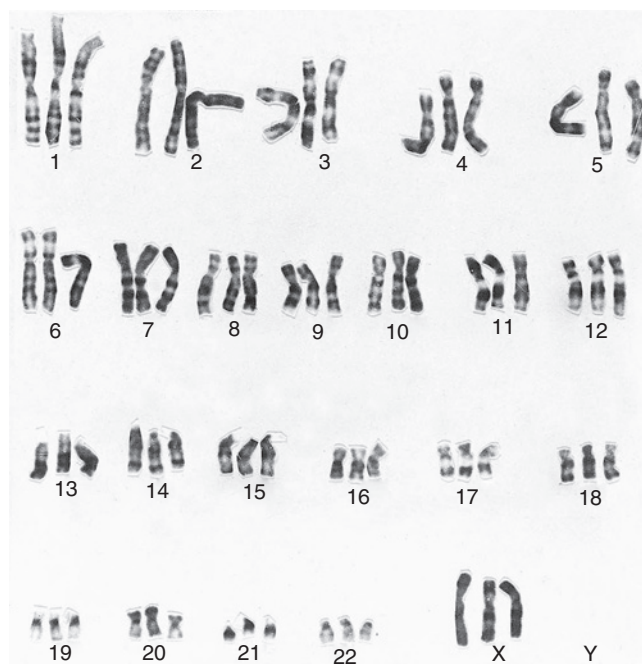


FIGURE 3.16 Karyotype from products of conception of a spontaneous miscarriage showing triploidy.

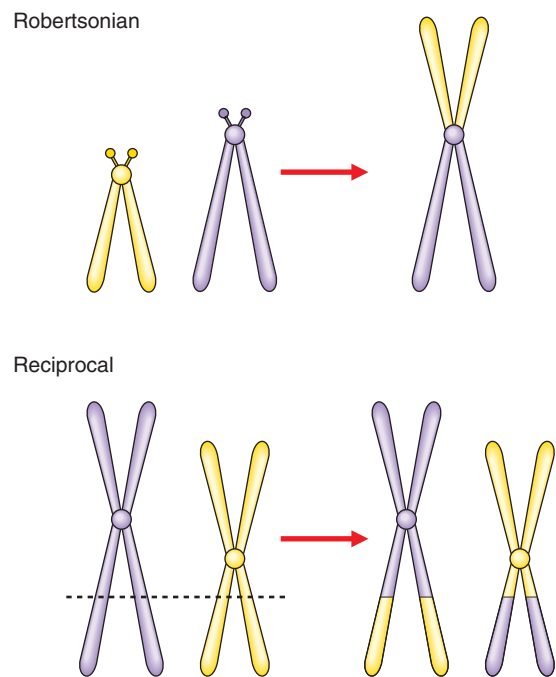


FIGURE 3.17 Types of translocation.

When a chromosome rearrangement is unbalanced the chromosomal complement contains an incorrect amount of chromosome material and the clinical effects are usually serious.

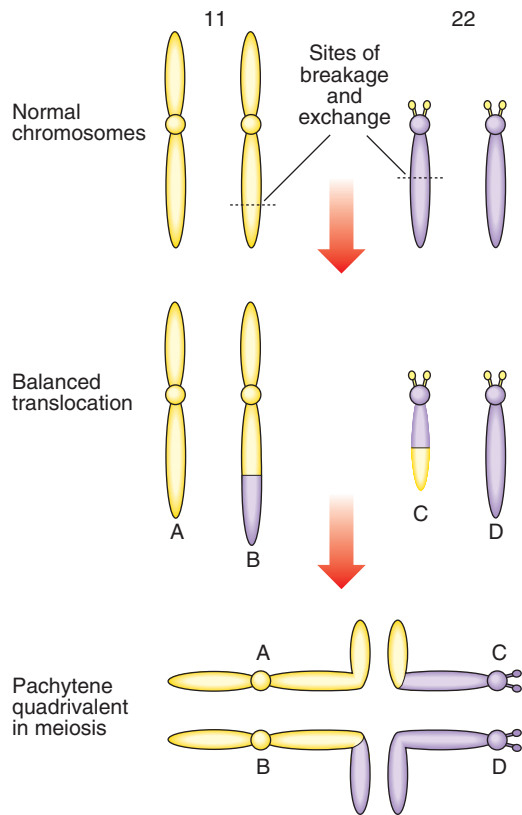
### Translocations

A **translocation** refers to the transfer of genetic material from one chromosome to another. A reciprocal translocation is formed when a break occurs in each of two chromosomes with the segments being exchanged to form two new derivative chromosomes. A Robertsonian translocation is a particular type of reciprocal translocation in which the breakpoints are located at, or close to, the centromeres of two acrocentric chromosomes (Figure 3.17).

#### Reciprocal Translocations

A reciprocal translocation involves breakage of at least two chromosomes with exchange of the fragments. Usually the chromosome number remains at 46 and, if the exchanged fragments are of roughly equal size, a reciprocal translocation can be identified only by detailed chromosomal banding studies or FISH (see Figure 3.9). In general, reciprocal translocations are unique to a particular family, although, for reasons that are unknown, a particular balanced reciprocal translocation involving the long arms of chromosomes 11 and 22 is relatively common. The overall incidence of reciprocal translocations in the general population is approximately 1 in 500.

**Segregation at Meiosis.** The importance of balanced reciprocal translocations lies in their behavior at meiosis, when they can segregate to generate significant chromosome imbalance. This can lead to early pregnancy loss or to the birth of an infant with multiple abnormalities. Problems arise at meiosis because the chromosomes involved in the translocation cannot pair normally to form bivalents. Instead they form a cluster known as a pachytene quadrivalent (Figure 3.18). The key point to note is that each chromosome aligns with homologous material in the quadrivalent.



**FIGURE 3.18** How a balanced reciprocal translocation involving chromosomes 11 and 22 leads to the formation of a quadrivalent at pachytene in meiosis I. The quadrivalent is formed to maintain homologous pairing.

**2:2 Segregation.** When the constituent chromosomes in the quadrivalent separate during the later stages of meiosis I, they can do so in several different ways (Table 3.5). If alternate chromosomes segregate to each gamete, the gamete will carry a normal or balanced haploid complement (Figure 3.19) and with fertilization the embryo will either have normal chromosomes or carry the balanced rearrangement. If, however, adjacent chromosomes segregate together, this will invariably result in the gamete acquiring an unbalanced chromosome complement. For example, in Figure 3.18, if the gamete inherits the normal number 11 chromosome (A) and the derivative number 22 chromosome (C), then fertilization will result in an embryo with monosomy for the distal long arm of chromosome 22 and trisomy for the distal long arm of chromosome 11.

**3:1 Segregation.** Another possibility is that three chromosomes segregate to one gamete with only one chromosome in the other gamete. If, for example, in Figure 3.18 chromosomes 11 (A), 22 (D) and the derivative 22 (C) segregate together to a gamete that is subsequently fertilized, this will result in the embryo being trisomic for the material present in the derivative 22 chromosome. This is sometimes referred to as **tertiary trisomy**. Experience has shown that, with this particular reciprocal translocation, tertiary trisomy for the derivative 22 chromosome is the only viable unbalanced product. All other patterns of malsegregation lead to early pregnancy loss. Unfortunately, tertiary trisomy for the derivative 22 chromosome is a serious condition in which affected children have multiple congenital abnormalities and severe learning difficulties.

**Risks in Reciprocal Translocations.** When counseling a carrier of a balanced translocation it is necessary to consider the particular rearrangement to determine whether it could result in the birth of an abnormal baby. This risk is usually somewhere between 1% and 10%. For carriers of the 11;22 translocation discussed, the risk has been shown to be 5%.

*Robertsonian Translocations*

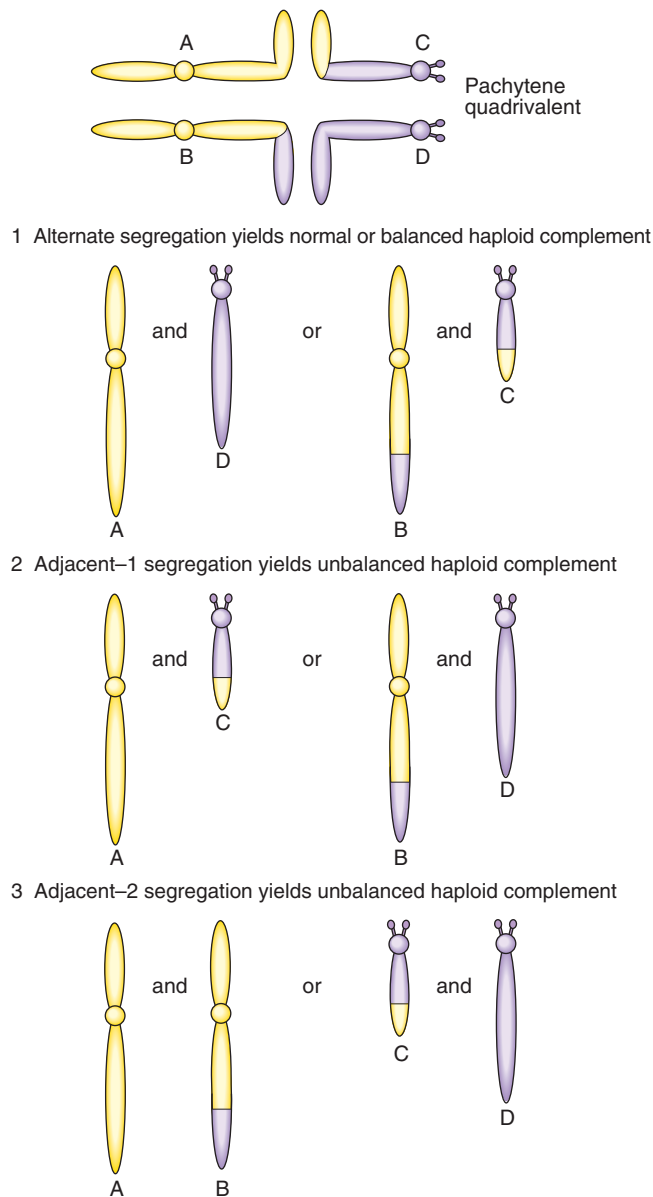
A Robertsonian translocation results from the breakage of two acrocentric chromosomes (numbers 13, 14, 15, 21, and 22) at or close to their centromeres, with subsequent fusion of their long arms (see Figure 3.17). This is also referred to as **centric fusion**. The short arms of each chromosome are lost, this being of no clinical importance as they contain genes only for ribosomal RNA, for which there are multiple copies on the various other acrocentric chromosomes. The total chromosome number is reduced to 45. Because there is no loss or gain of important genetic material, this is a functionally balanced rearrangement. The overall incidence of Robertsonian translocations in the general population is approximately 1 in 1000, with by far the most common being fusion of the long arms of chromosomes 13 and 14 (13q14q).

**Segregation at Meiosis.** As with reciprocal translocations, the importance of Robertsonian translocations lies in their behavior at meiosis. For example, a carrier of a 14q21q translocation can produce gametes with (Figure 3.20):

1. A normal chromosome complement (i.e., a normal 14 and a normal 21).
2. A balanced chromosome complement (i.e., a 14q21q translocation chromosome).
3. An unbalanced chromosome complement possessing both the translocation chromosome and a normal 21. This will result in the fertilized embryo having Down syndrome.

**Table 3.5** Patterns of Segregation of a Reciprocal Translocation (see Figures 3.18 and 3.19)

Pattern of Segregation	Segregating Chromosomes	Chromosome Constitution in Gamete
<b>2:2</b>		
Alternate	A + D	Normal
	B + C	Balanced translocation
Adjacent-1 (non-homologous centromeres segregate together)	A + C or B + D	Unbalanced, leading to a combination of partial monosomy and partial trisomy in the zygote
	A + B or C + D	
<b>3:1</b>		
Three chromosomes	A + B + C	Unbalanced, leading to trisomy in the zygote
	A + B + D	
	A + C + D	
	B + C + D	
One chromosome	A	Unbalanced, leading to monosomy in the zygote
	B	
	C	
	D	



**FIGURE 3.19** The different patterns of 2:2 segregation that can occur from the quadrivalent shown in Figure 3.18. (See Table 3.5.)

- An unbalanced chromosome complement with a normal 14 and a missing 21.
- An unbalanced chromosome complement with a normal 21 and a missing 14.
- An unbalanced chromosome complement with the translocation chromosome and a normal 14 chromosome.

The last three combinations will result in zygotes with monosomy 21, monosomy 14, and trisomy 14, respectively. All of these combinations are incompatible with survival beyond early pregnancy.

**Translocation Down Syndrome.** The major practical importance of Robertsonian translocations is that they can predispose to the birth of babies with Down syndrome as a result of the embryo inheriting two normal number 21 chromosomes (one from each parent) plus a translocation chromosome involving a number 21 chromosome (Figure 3.21). Translocation Down syndrome accounts for 2% to 3% of cases and the clinical

consequences are exactly the same as those seen in pure trisomy 21. However, unlike trisomy 21, the parents of a child with translocation Down syndrome have a relatively high risk of having further affected children if one of them carries the rearrangement in a balanced form.

Consequently, the importance of performing a chromosome analysis in a child with Down syndrome lies not only in confirmation of the diagnosis, but also in identification of those children with a translocation. In roughly two-thirds of these latter children with Down syndrome, the translocation will have occurred as a new (*de novo*) event in the child, but in the remaining one-third one of the parents will be a carrier. Other relatives might also be carriers. Therefore it is regarded as essential that efforts are made to identify all adult translocation carriers in a family so that they can be alerted to possible risks to future offspring. This is sometimes referred to as translocation **tracing**, or 'chasing'.

**Risks in Robertsonian Translocations.** Studies have shown that the female carrier of either a 13q21q or a 14q21q Robertsonian translocation runs a risk of approximately 10% for having a baby with Down syndrome, whereas for male carriers the risk is 1% to 3%. It is worth sparing a thought for the unfortunate carrier of a 21q21q Robertsonian translocation. All gametes will be either nullisomic or disomic for chromosome 21. Consequently, all pregnancies will end either in spontaneous miscarriage or in the birth of a child with Down syndrome. This is one of the very rare situations in which offspring are at a risk of greater than 50% for having an abnormality. Other examples are parents who are both heterozygous for the same autosomal dominant disorder (p. 69), and parents who are both homozygous for the same gene mutation causing an autosomal recessive disorder, such as sensorineural deafness.

## Deletions

A **deletion** involves loss of part of a chromosome and results in monosomy for that segment of the chromosome. A very large deletion is usually incompatible with survival to term, and as a general rule any deletion resulting in loss of more than 2% of the total haploid genome will have a lethal outcome.

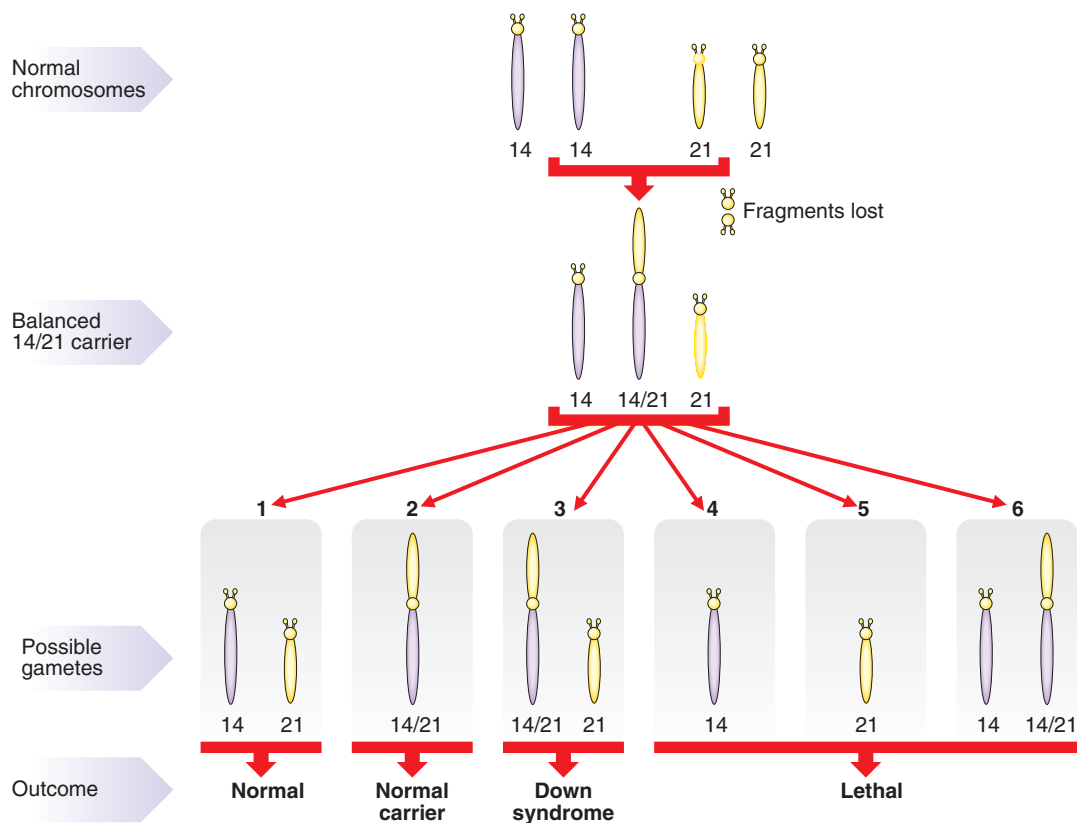
Deletions are now recognized as existing at two levels. A 'large' chromosomal deletion can be visualized under the light microscope. Such deletion syndromes include Wolf-Hirschhorn and cri du chat, which involve loss of material from the short arms of chromosomes 4 and 5, respectively (p. 243). Sub-microscopic microdeletions were identified with the help of high-resolution prometaphase cytogenetics augmented by FISH studies and include Prader-Willi and Angelman syndromes (p. 78).

## Insertions

An **insertion** occurs when a segment of one chromosome becomes inserted into another chromosome. If the inserted material has moved from elsewhere in another chromosome then the karyotype is balanced. Otherwise an insertion causes an unbalanced chromosome complement. Carriers of a balanced deletion-insertion rearrangement are at a 50% risk of producing unbalanced gametes, as random chromosome segregation at meiosis will result in 50% of the gametes inheriting either the deletion or the insertion, but not both.

## Inversions

An inversion is a two-break rearrangement involving a single chromosome in which a segment is reversed in position (i.e.,



**FIGURE 3.20** Formation of a 14q21q Robertsonian translocation and the possible gamete chromosome patterns that can be produced at meiosis.

inverted). If the inversion segment involves the centromere it is termed a **pericentric inversion** (Figure 3.22A). If it involves only one arm of the chromosome it is known as a **paracentric inversion** (Figure 3.22B).

Inversions are balanced rearrangements that rarely cause problems in carriers unless one of the breakpoints has disrupted an important gene. A pericentric inversion involving

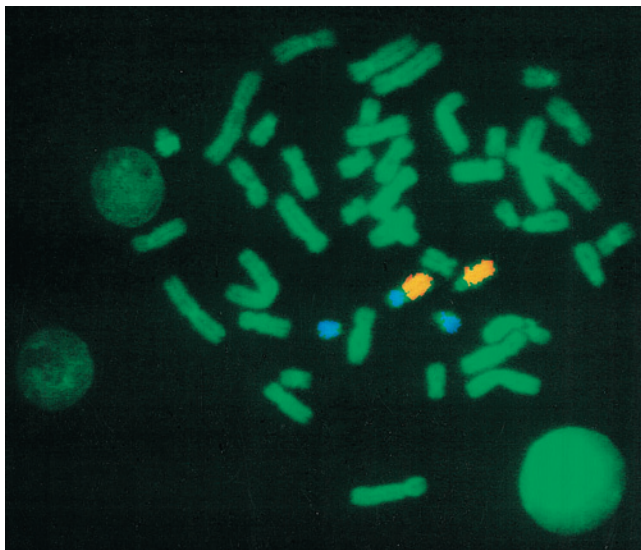
chromosome number 9 occurs as a common structural variant or polymorphism, also known as a **heteromorphism**, and is not thought to be of any functional importance. However, other inversions, although not causing any clinical problems in balanced carriers, can lead to significant chromosome imbalance in offspring, with important clinical consequences.

*Segregation at Meiosis*

**Pericentric Inversions.** An individual who carries a pericentric inversion can produce unbalanced gametes if a crossover occurs within the inversion segment during meiosis I, when an inversion loop forms as the chromosomes attempt to maintain homologous pairing at synapsis. For a pericentric inversion, a crossover within the loop will result in two complementary recombinant chromosomes, one with duplication of the distal non-inverted segment and deletion of the other end of the chromosome, and the other having the opposite arrangement (Figure 3.23A).

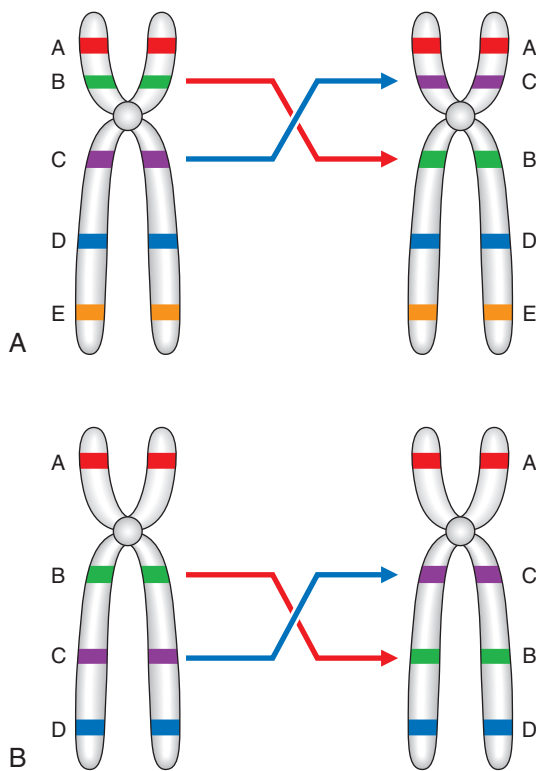
If a pericentric inversion involves only a small proportion of the total length of a chromosome then, in the event of crossing over within the loop, the duplicated and deleted segments will be relatively large. The larger these are, the more likely it is that their effects on the embryo will be so severe that miscarriage ensues. For a large pericentric inversion, the duplicated and deleted segments will be relatively small so that survival to term and beyond becomes more likely. Thus, in general, the larger the size of a pericentric inversion the more likely it becomes that it will result in the birth of an abnormal infant.

The pooled results of several studies have shown that a carrier of a balanced pericentric inversion runs a risk of approximately 5% to 10% for having a child with viable imbalance if



**FIGURE 3.21** Chromosome painting showing a 14q21q Robertsonian translocation in a child with Down syndrome. Chromosome 21 is shown in blue and chromosome 14 in yellow. (Courtesy Meg Heath, City Hospital, Nottingham, UK.)





**FIGURE 3.22** **A**, Pericentric and, **B**, paracentric inversions. (Courtesy Dr. J. Delhanty, Galton Laboratory, London.)

that inversion has already resulted in the birth of an abnormal baby. The risk is nearer 1% if the inversion has been ascertained because of a history of recurrent miscarriage.

**Paracentric Inversions.** If a crossover occurs in the inverted segment of a paracentric inversion, this will result in recombinant chromosomes that are either acentric or dicentric (Figure 3.23B). Acentric chromosomes, which strictly speaking should be known as chromosomal fragments, cannot undergo mitotic division, so that survival of an embryo with such a rearrangement is extremely uncommon. Dicentric chromosomes are inherently unstable during cell division and are, therefore, also unlikely to be compatible with survival of the embryo. Thus, overall, the likelihood that a balanced parental paracentric inversion will result in the birth of an abnormal baby is extremely low.

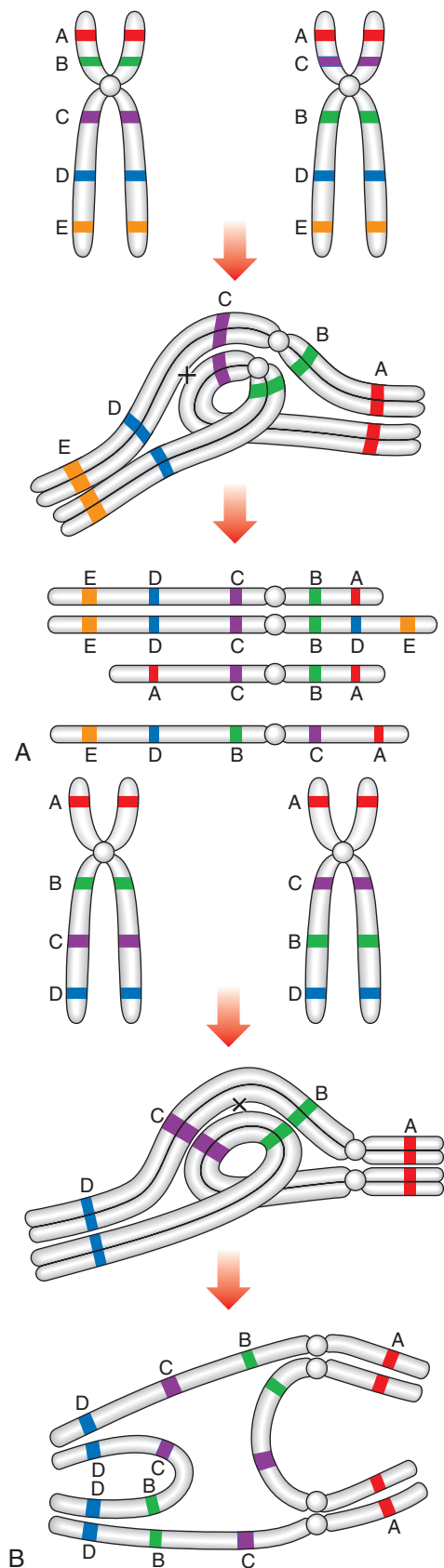
### Ring Chromosomes

A **ring chromosome** is formed when a break occurs on each arm of a chromosome leaving two 'sticky' ends on the central portion that reunite as a ring (Figure 3.24). The two distal chromosomal fragments are lost so that, if the involved chromosome is an autosome, the effects are usually serious.

Ring chromosomes are often unstable in mitosis so that it is common to find a ring chromosome in only a proportion of cells. The other cells in the individual are usually monosomic because of the absence of the ring chromosome.

### Isochromosomes

An isochromosome shows loss of one arm with duplication of the other. The most probable explanation for the formation of an isochromosome is that the centromere has divided transversely rather than longitudinally. The most commonly



**FIGURE 3.23** Mechanism of production of recombinant unbalanced chromosomes from, **A**, pericentric and, **B**, paracentric inversions by crossing over in an inversion loop. (Courtesy Dr. J. Delhanty, Galton Laboratory, London.)



FIGURE 3.24 Partial karyotype showing a ring chromosome 9. (Courtesy Meg Heath, City Hospital, Nottingham.)

encountered isochromosome is that which consists of two long arms of the X chromosome. This accounts for up to 15% of all cases of Turner syndrome (p. 240).

## Mosaicism and Chimerism (Mixoploidy)

### Mosaicism

**Mosaicism** can be defined as the presence in an individual, or in a tissue, of two or more cell lines that differ in their genetic constitution but are derived from a single zygote, that is, they have the same genetic origin. Chromosome mosaicism usually results from non-disjunction in an early embryonic mitotic division with the persistence of more than one cell line. If, for example, the two chromatids of a number 21 chromosome failed to separate at the second mitotic division in a human zygote (Figure 3.25), this would result in the four-cell zygote having two cells with 46 chromosomes, one cell with 47 chromosomes (trisomy 21), and one cell with 45 chromosomes (monosomy 21). The ensuing cell line with 45 chromosomes would probably not survive, so that the resulting embryo would be expected to show approximately 33% mosaicism for trisomy 21. Mosaicism accounts for 1% to 2% of all clinically recognized cases of Down syndrome.

Mosaicism can also exist at a molecular level if a new mutation arises in a somatic or early germline cell division (p. 76). The possibility of germline or gonadal mosaicism is a particular

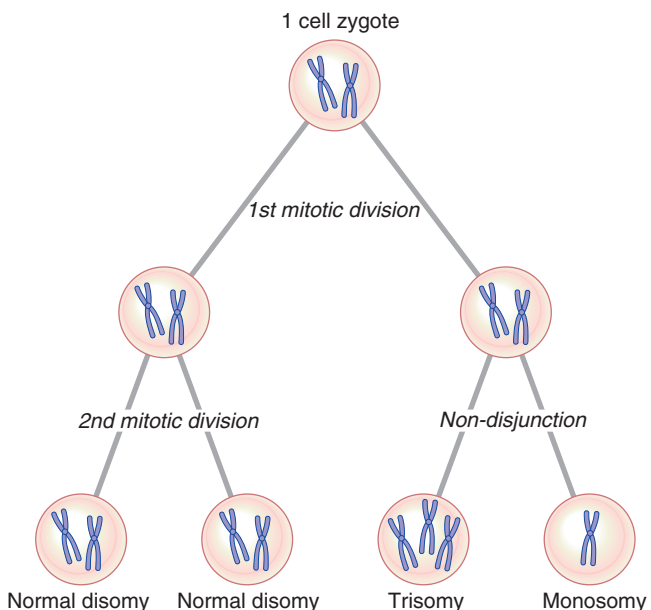


FIGURE 3.25 Generation of somatic mosaicism caused by mitotic non-disjunction.

concern when counseling the parents of a child in whom a condition such as Duchenne muscular dystrophy (p. 281) is an isolated case.

### Chimerism

**Chimerism** can be defined as the presence in an individual of two or more genetically distinct cell lines derived from more than one zygote; that is, they have a different genetic origin. The word *chimera* is derived from the mythological Greek monster that had the head of a lion, the body of a goat and the tail of a dragon. Human chimeras are of two kinds: dispermic chimeras and blood chimeras.

#### Dispermic Chimeras

These are the result of double fertilization whereby two genetically different sperm fertilize two ova and the resulting two zygotes fuse to form one embryo. If the two zygotes are of different sex, the chimeric embryo can develop into an individual with true hermaphroditism (p. 123) and an XX/XY karyotype. Mouse chimeras of this type can now be produced experimentally in the laboratory to facilitate the study of gene transfer.

#### Blood Chimeras

Blood chimeras result from an exchange of cells, via the placenta, between non-identical twins in utero. For example, 90% of one twin's cells can have an XY karyotype with red blood cells showing predominantly blood group B, whereas 90% of the cells of the other twin can have an XX karyotype with red blood cells showing predominantly blood group A. It has long been recognized that, when twin calves of opposite sex are born, the female can have ambiguous genitalia. This is because the female calf, known as a **freemartin**, has acquired the XY component in utero via vascular connections between the placentas and becomes masculinized through exposure to male hormones.

### FURTHER READING

Gardner, R.J.M., Sutherland, G.R., Shaffer, L.G., 2013. *Cytogenetic abnormalities and genetic counselling*, 4th ed. Oxford Medicine.

*A richly-illustrated resource, combining basic concepts of chromosomal analysis with practical applications of recent advances in molecular cytogenetics.*

Gersen, S.L., Keagle, M.B. (Eds.), 2013. *The principles of clinical cytogenetics*, 3rd ed. Humana Press, Totowa, NJ.

*A detailed multi-author guide to all aspects of laboratory and clinical cytogenetics.*

Shaffer, L.G., McGowan-Jordan, J., Schmid, M. (Eds.), 2013. *An international system for human cytogenetic nomenclature*. Karger, Basel.

*An indispensable reference guide giving details of how chromosome abnormalities should be described.*

Speicher, M.R., Carter, N.P., 2006. The new cytogenetics: blurring the boundaries with molecular biology. *Nat Rev Genet* 6, 782–792.

*A review of molecular cytogenetic techniques.*

Tjio, J.H., Levan, A., 1956. The chromosome number of man. *Hereditas* 42, 1–6.

*A landmark paper that described a reliable method for studying human chromosomes and gave birth to the subject of clinical cytogenetics.*

### Website

National Center for Biotechnology Information. Microarrays: chipping away at the mysteries of science and medicine. Online. <http://www.auburn.edu/academic/classes/biol/3020/iActivities/CGAP/Microarrays%20Factsheet.htm>

**ELEMENTS**

- 1 The normal human karyotype is made up of 46 chromosomes consisting of 22 pairs of autosomes and a pair of sex chromosomes, XX in the female and XY in the male.
- 2 Each chromosome consists of a short (p) and long (q) arm joined at the centromere. Chromosomes are analyzed using cultured cells, and specific banding patterns can be identified by means of special staining techniques. Molecular cytogenetic techniques, such as fluorescence in-situ hybridization (FISH) can be used to detect and characterize subtle chromosome abnormalities.
- 3 During mitosis in somatic cell division the two sister chromatids of each chromosome separate, with one chromatid passing to each daughter cell. During meiosis, which occurs during the final stage of gametogenesis, homologous chromosomes pair, exchange segments, and then segregate independently to the mature daughter gametes.
- 4 Chromosome abnormalities can be structural or numerical. Numerical abnormalities include trisomy and polyploidy. In trisomy a single extra chromosome is present, usually as a result of non-disjunction in the first or second meiotic division. In polyploidy, three or more complete haploid sets are present instead of the usual diploid complement.
- 5 Structural abnormalities include translocations, inversions, insertions, rings, and deletions. Translocations can be balanced or unbalanced. Carriers of balanced translocations are at risk of having children with unbalanced rearrangements; these children are often severely affected.

## Chapter 4

# Finding the Cause of Monogenic Disorders by Identifying Disease Genes

A disease or disorder is defined as **rare** in Europe when it affects less than 1 in 2000. In the United States the definition is that fewer than 200,000 Americans are affected at any given time. It is estimated that there are more than 6000 rare disorders, which means that, collectively, these rare diseases are not uncommon and they affect up to 1 in 17 of the European population. More than 80% have a genetic basis, whilst others result from infections, allergies, and environmental causes, or are degenerative and proliferative.

Identification of the gene associated with an inherited single-gene (**monogenic**) disorder, as well as having immediate clinical diagnostic application, will enable an understanding of the developmental basis of the pathology with the prospect of possible therapeutic interventions. The molecular basis for more than 4500 disease phenotypes is now known and the rate at which single-gene disorder genes are being identified continues to increase exponentially.

The first human disease genes identified were those with a biochemical basis where it was possible to purify and sequence the gene product. The development of recombinant DNA techniques in the 1980s enabled physical mapping strategies and led to a new approach, positional cloning. This describes the identification of a gene purely on the basis of its location, without any prior knowledge of its function. Notable early successes were the identification of the dystrophin gene (mutated in Duchenne muscular dystrophy) and the cystic fibrosis transmembrane regulatory gene. Patients with chromosome abnormalities or rearrangements have often provided important clues by highlighting the likely chromosomal region of a gene associated with disease (Table 4.1).

In the 1990s a genome-wide set of microsatellites was constructed with approximately one marker per 10 centimorgans (cM). These 350 markers could be amplified by polymerase chain reaction (PCR) and facilitated genetic mapping studies that led to the identification of thousands of genes. This approach was superseded by DNA microarrays or 'single nucleotide polymorphism (SNP) chips'. Although SNPs (p. 50) are less informative than microsatellites, they can be scored automatically and microarrays are commercially available with several million SNPs distributed throughout the genome.

The common step for all approaches to identify human disease genes is the identification of a candidate gene (Figure 4.1). Candidate genes may be suggested from animal models of disease or by **homology**, either to a **paralogous** human gene (e.g., where multigene families exist) or to an **orthologous** gene in another species. With the sequencing of the human genome now complete, it is also possible to find new disease genes by searching through genetic databases (i.e., '*in silico*').

Recent developments in sequencing technology mean that **exome** sequencing (analysis of the coding regions of all known

genes) or whole genome sequencing are now feasible strategies for identifying disease genes by direct identification of the causal mutation in a family (or families) with one or more affected individuals. Consequently, the timescale for identifying human disease genes has decreased dramatically from a period of years (e.g., the search for the cystic fibrosis gene in the 1980s) to weeks or even days.

### Position-Independent Identification of Human Disease Genes

Before genetic mapping techniques were developed, the first human disease genes were identified through knowledge of the protein product. For disorders with a biochemical basis, this was a particularly successful strategy.

### Functional Cloning

**Functional cloning** describes the identification of a human disease gene through knowledge of its protein product. From the amino-acid sequence of a protein, oligonucleotide probes could be synthesized to act as probes for screening complementary DNA (cDNA) libraries (p. 44).

An alternative approach was to generate an antibody to the protein for screening of a cDNA expression library.

### Use of Animal Models

The recognition of phenotypic features in a model organism, such as the mouse, which are similar to those seen in persons affected with an inherited disorder, allowed the possibility of cloning the gene in the model organism to lead to more rapid

**Table 4.1** Historical Strategies for Disease Gene Identification

Year	Strategy	Examples of Application
1985	Patients with chromosome abnormalities	DMD mutations causing Duchenne muscular dystrophy
1989	Linkage mapping	CFTR mutations causing cystic fibrosis
1990s	Autozygosity mapping	Many recessive disease genes identified in consanguineous pedigrees
1992	Animal models	PAX3 mutations causing Waardenburg syndrome
1999	RAPID cloning of trinucleotide repeat expansion	CTG repeat expansion causing spinocerebellar ataxia type 8
2010	Exome sequencing	DHOD mutations causing Miller syndrome

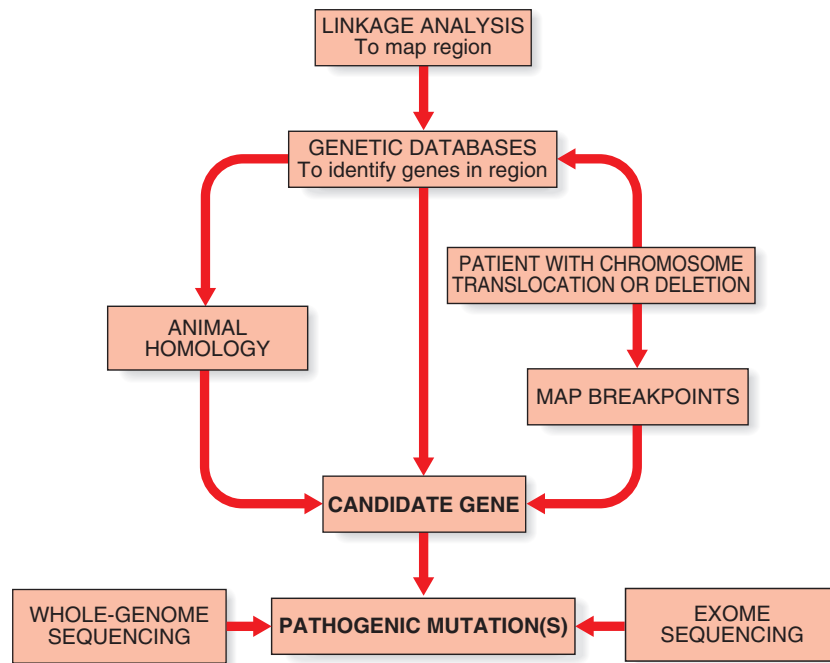


FIGURE 4.1 Pathways toward human disease gene identification.

identification of the gene responsible in humans. An example of this approach was the mapping of the gene responsible for the inherited disorder of pigmentation and deafness known as Waardenburg syndrome (p. 109) to the long arm of human chromosome 2. This region of chromosome 2 shows extensive homology, or what is known as **synteny**, to the region of mouse chromosome 1 to which the gene for the murine pigimentary mutant known as *Spotch* had been assigned. The mapping of the murine *Pax3* gene, which codes for a transcription factor expressed in the developing nervous system, to this region suggested it as a **positional candidate gene** for the disorder. It was suggested that the pigimentary abnormalities could arise on the basis that melanocytes, in which melanin synthesis takes place, are derived from the neural crest. Identification of mutations in *PAX3*, the human homolog, confirmed it as the gene responsible for Waardenburg syndrome.

### Mapping Trinucleotide Repeat Disorders

A number of human diseases are attributable to expansions of trinucleotide repeats (see Table 2.5), and in particular CAG repeat expansions which cause extended polyglutamate tracts in Huntington disease and many forms of spinocerebellar ataxia. A method developed to seek novel trinucleotide repeat expansions in genomic DNA from affected patients led to the successful identification of a CTG repeat expansion in patients with spinocerebellar ataxia type 8.

### Positional Cloning

**Positional cloning** describes the identification of a disease gene through its location in the human genome, without prior knowledge of its function. It is also described as **reverse genetics** as it involves an approach opposite to that of functional cloning, in which the protein is the starting point.

### Linkage Analysis

Genetic mapping, or linkage analysis (p. 90), is based on genetic distances that are measured in centimorgans (cM). A genetic

distance of 1 cM is the distance between two genes that show 1% recombination, that is, in 1% of meioses the genes will not be co-inherited and is equivalent to approximately 1 Mb (1 million bases). Linkage analysis is the first step in positional cloning that defines a genetic interval for further analysis.

Linkage analysis can be performed for a single, large family or for multiple families, although this assumes that there is no genetic heterogeneity (p. 317). The use of genetic markers located throughout the genome is described as a **genome-wide scan**. In the 1990s, genome-wide scans used microsatellite markers (a commercial set of 350 markers was popular), but were replaced with microarrays where analysis of several million SNPs provided greater statistical power.

**Autozygosity mapping** (also known as homozygosity mapping) is a powerful form of linkage analysis used to map autosomal recessive disorders in consanguineous pedigrees (p. 320). Autozygosity occurs when affected members of a family are homozygous at particular loci because they are identical by descent from a common ancestor.

In the mid-1980s, linkage of cystic fibrosis (CF) to chromosome 7 was found by testing nearly 50 Caucasian families with hundreds of DNA markers. The gene was mapped to a region of 500 kilobases (kb) between markers *MET* and *D7S8* at chromosome band 7q31-32, when it became evident that the majority of CF chromosomes had a particular set of alleles for these markers (shared haplotype) that was found in only 25% of non-CF chromosomes. This finding is described as **linkage disequilibrium** and suggests a common mutation from a founder effect (p. 92). Extensive physical mapping studies eventually led to the identification of four genes within the genetic interval identified by linkage analysis, and in 1989 a 3-bp deletion was found within the cystic fibrosis transmembrane receptor (*CFTR*) gene. This mutation (p.Phe508del) was present in approximately 70% of CF chromosomes and 2% to 3% of non-CF chromosomes, consistent with the carrier frequency of 1 in 25 in Caucasians.

## Contig Analysis

The aim of linkage analysis is to reduce the region of linkage as far as possible to identify a candidate region. Before publication of the human genome sequence, the next step was to construct a **contig**. This contig would contain a series of overlapping fragments of cloned DNA representing the entire candidate region. These cloned fragments were then used to screen cDNA libraries, to search for CpG islands (which are usually located close to genes), for zoo blotting (selection based on evolutionary conservation) and exon trapping (to identify coding regions via functional splice sites). The requirement for cloning the region of interest led to the phrase ‘cloning the gene’ for a particular disease.

## Chromosome Abnormalities

Occasionally, individuals are recognized with single-gene disorders that are also found to have structural chromosomal abnormalities. The first clue that the gene responsible for Duchenne muscular dystrophy (DMD) (p. 281) was located on the short arm of the X chromosome was the identification of a number of females with DMD who were also found to have a chromosomal rearrangement between an autosome and a specific region of the short arm of one of their X chromosomes. Isolation of DNA clones spanning the region of the X chromosome involved in the rearrangement led in one such female to more detailed gene-mapping information as well as to the eventual cloning of the *DMD* or dystrophin gene (p. 281).

At the same time as these observations, a male was reported with three X-linked disorders: DMD, chronic granulomatous disease, and retinitis pigmentosa. He also had an unusual X-linked red cell group known as the McLeod phenotype. It was suggested that he could have a deletion of a number of genes on the short arm of his X chromosome, including the *DMD* gene, or what is now termed a **contiguous gene syndrome**. Detailed prometaphase chromosome analysis revealed this to be the case. DNA from this individual was used in vast excess to hybridize in competitive reassociation, under special conditions, with DNA from persons with multiple X chromosomes to enrich for DNA sequences that he lacked, the so-called *phenol enhanced reassociation technique*, or pERT, which allowed isolation of DNA clones containing portions of the *DMD* gene.

## Candidate Genes

Searching databases for genes with a function likely to be involved in the pathogenesis of the inherited disorder can also suggest what are known as **candidate genes**. If a disease has been mapped to a particular chromosomal region, any gene mapping to that region is a positional candidate gene. Data on the pattern of expression, the timing, and the distribution of tissue and cells types may suggest that a certain positional candidate gene or genes is more likely to be responsible for the phenotypic features seen in persons affected with a particular single-gene disorder. Software tools are used to search genomic DNA sequence databases for sequence homology to known genes, as well as DNA sequences specific to all genes, such as the conserved intron–exon splice junctions, promoter sequences, polyadenylation sites and stretches of open reading frames (ORFs).

Identification of a gene with homology to a known gene causing a recognized inherited disorder can suggest it as a possible candidate gene for other inherited disorders with a

similar phenotype. For example, the identification of mutations in the connexin 26 gene, which codes for one of the proteins that constitute the gap junctions between cells causing sensorineural hearing impairment or deafness, has led to the identification of other connexins responsible for inherited hearing impairment or deafness.

## Confirmatory Testing That a Candidate Gene Is a Disease Gene

Finding loss-of-function mutations or multiple different mutations that result in the same phenotype provides supporting evidence that a potential candidate gene is associated with a disorder. For example, in the absence of functional data to demonstrate the effect of the p.Phe508del mutation on the CFTR protein, confirmation that mutations in the *CFTR* gene caused cystic fibrosis was provided by the nonsense mutation p.Gly542X.

Further evidence is sought from gene expression studies to check that the candidate gene is expressed in the appropriate tissues and at the relevant stages of development. The production of a transgenic animal model by the targeted introduction of the mutation into the homologous gene in another species that is shown to exhibit phenotypic features similar to those seen in persons affected with the disorder, or restoration of the normal phenotype by transfection of the normal gene into a cell line, provides final proof that the candidate gene and the disease gene are one and the same.

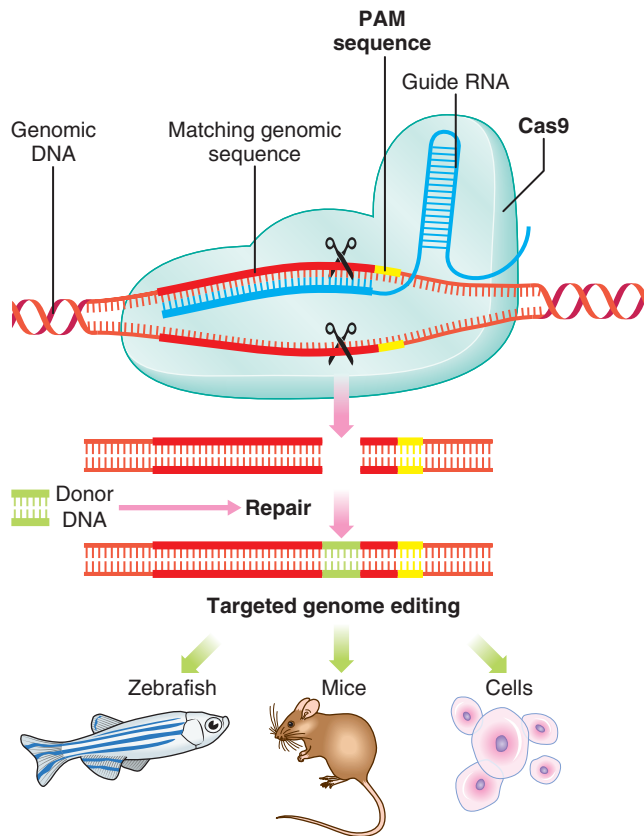
Generating transgenic animal models is a lengthy and expensive process but a new genome editing technology, CRISPR/Cas9 (clustered regularly interspaced short palindromic repeat/CRISPR-associated 9), provides a powerful tool to investigate gene mutations identified in patients either in cellular systems or animal models (Figure 4.2). This system uses a guide RNA (gRNA) to recruit Cas9 nuclease to the target locus by sequence complementarity and induces double strand breaks (DSBs). These DSBs can be used to introduce specific sequence modifications through a homology-dependent repair mechanism. By microinjecting synthesized RNAs and donor DNA sequences into mouse zygotes it is possible to introduce a mouse model with a specific gene mutation within a few months.

## The Human Genome Project

### Beginning the Human Genome Project

The concept of a map of the human genome was first proposed in 1969 by Victor McKusick (see Figure 1.5, p. 5), one of the founding fathers of medical genetics. Human gene mapping workshops were held regularly from 1973 to collate the mapping data. The idea of a dedicated human genome project came from a meeting in 1986. The US Human Genome Project started in 1991 and is estimated to have cost approximately 2.7 billion US dollars. Other nations, notably France, the UK, and Japan, soon followed with their own major national human genome programs and were subsequently joined by a number of other countries. These individual national projects were coordinated by the Human Genome Organization (HUGO), an international organization created to foster collaboration between genome scientists.

Although the key objective of the Human Genome Project was to sequence all  $3 \times 10^9$  base pairs of the human genome, this was just one of the six main objectives/areas of work of the Human Genome Project.



**FIGURE 4.2** Schematic illustration of genome editing using CRISPR/Cas 9 technology. A guide RNA (gRNA) is designed to match the genomic sequence of interest. The gRNA is designed to target the genomic sequence of 19–23 bp at the 5' side of the PAM (NGG sequence). The gRNA recruits Cas9 nuclease to the target locus and induces double strand breaks (indicated by scissors). The donor DNA sequence is introduced by homology-dependent repair. CRISPR/Cas 9 technology can be used to generate modified bacterial or human cells for *in vitro* studies or a range of different animal models for *in vivo* investigation.

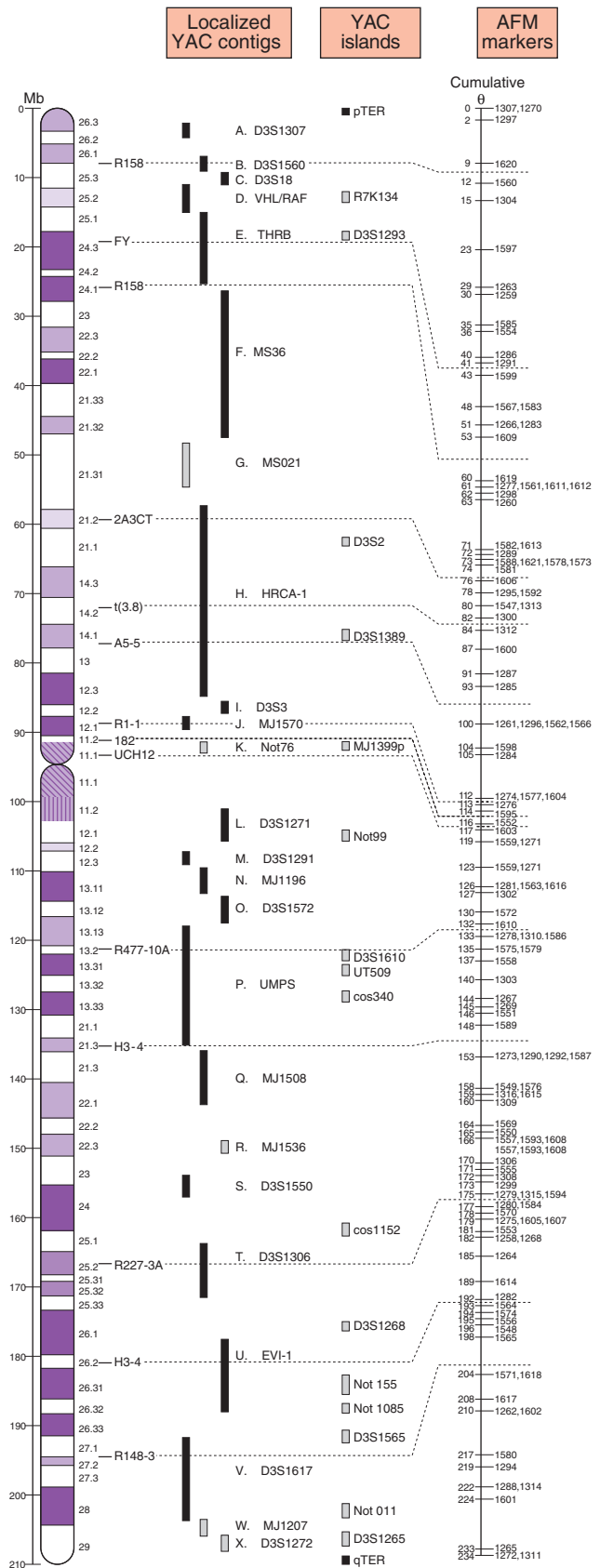
### Human Gene Maps and Mapping of Human Inherited Diseases

Designated genome mapping centers were involved in the coordination and production of genetic or recombination and physical maps of the human genome. The genetic maps initially involved the production of fairly low-level resolution maps based on polymorphic variable-number di-, tri-, and tetranucleotide tandem repeats (p. 11) spaced at approximately 10-cM intervals throughout the genome.

The mapping information from these genetic maps was integrated with high-resolution physical maps (Figure 4.3). Access to the detailed information from these high-resolution genetic and physical maps allowed individual research groups, often interested in a specific or particular inherited disease or group of diseases, rapidly and precisely to localize or map a disease gene to a specific region of a chromosome.

### Development of New DNA Technologies

A second major objective was the development of new DNA technologies for human genome research. For example, at the outset of the Human Genome Project, the technology involved



**FIGURE 4.3** A summary map of human chromosome 3, estimated to be 210 Mb in size, which integrates physical mapping data covered by 24 YAC contigs and the Genethon genetic map with cumulative map distances. (From Gemmill RM, Chumakov I, Scott P, et al 1995 A second-generation YAC contig map of human chromosome 3. *Nature* 377:299–319; with permission.)

in DNA sequencing was very time consuming, laborious and relatively expensive. The development of high-throughput automated capillary sequencers and robust fluorescent sequencing kits transformed the ease and cost of large-scale DNA sequencing projects.

### Sequencing of the Human Genome

Although sequencing of the entire human genome would have been seen to be the obvious main focus of the Human Genome Project, initially it was not the straightforward proposal it seemed. The human genome contains large sections of repetitive DNA (p. 11) that were technically difficult to clone and sequence. In addition, it would seem a waste of time to collect sequence data on the entire genome when only a small proportion is made up of expressed sequences or genes, the latter being most likely to be the regions of greatest medical and biological importance. Furthermore, the sheer magnitude of the prospect of sequencing all  $3 \times 10^9$  base pairs of the human genome seemed overwhelming. With conventional sequencing technology, as was carried out in the early 1990s, it was estimated that a single laboratory worker could sequence up to approximately 2000 bp per day.

Projects involving sequencing of other organisms with smaller genomes showed how much work was involved as well as how the rate of producing sequence data increased with the development of new DNA technologies. For example, with initial efforts at producing genome sequence data for yeast, it took an international collaboration involving 35 laboratories in 17 countries from 1989 until 1995 to sequence just 315,000 bp of chromosome 3, one of the 16 chromosomes that make up the 14 million base pairs of the yeast genome. Advances in DNA technologies meant, however, that by the middle of 1995 more than half of the yeast genome had been sequenced, with the complete genomic sequence being reported the following year.

Further advances in DNA sequencing technology led to publication of the full sequence of the nematode *Caenorhabditis elegans* in 1998 and the 50 million base pairs of the DNA sequence of human chromosome 22 at the end of 1999. As a consequence of these technical developments, the 'working draft' sequence, covering 90% of the human genome, was published in February 2001. The finished sequence (more than 99% coverage) was announced more than 2 years ahead of schedule in April 2003, the 50th anniversary of the discovery of the DNA double helix. Researchers now have access to the full catalog of approximately 20,000 genes, and the human genome sequence will underpin biomedical research for decades to come.

### Ethical, Legal, and Social Issues of the Human Genome Project

The rapid advances in the science and application of developments from the Human Genome Project presented complex ethical issues for both the individual and society. These issues included ones of immediate practical relevance, such as who owns and should control genetic information with respect to privacy and confidentiality; who is entitled to access to it and how; whether it should be used by employers, schools, etc.; the psychological impact and potential stigmatization of persons positive for genetic testing; and the use of genetic testing in reproductive decision making. Other issues include the concept of disability/differences that have a genetic basis in relation to the treatment of genetic disorders or diseases by gene therapy

and the possibility of genetic enhancement (i.e., using gene therapy to supply certain characteristics, such as height). Last, issues needed to be resolved with regard to the appropriateness and fairness of the use of the new genetic and genomic technologies with prioritization of the use of public resources and commercial involvement and property rights, especially with regard to patenting.

### Development of Bioinformatics

Bioinformatics was essential to the overall success of the Human Genome Project. This is an interdisciplinary field that develops methods and software tools for understanding biological data. Bioinformaticians were responsible for the establishment of facilities for collecting, storing, organizing, interpreting, analyzing, and communicating the data from the project to the scientific community at large. It was vital for anyone involved in any aspect of the Human Genome Project to have rapid and easy access to the data/information arising from it. This dissemination of information was met by the establishment of a large number of electronic databases available on the World Wide Web on the Internet (see Appendix). These include protein and DNA sequence databases (e.g., GenBank, EMBL), annotated genome data (Ensembl and UCSC Genome Bioinformatics) and the catalog of inherited diseases in humans (Online Mendelian Inheritance in Man, or OMIM).

### Comparative Genomics

In addition to the Human Genome Project, there were separate genome projects for a number of other species, for what are known as 'model organisms'. These included various prokaryotic organisms such as the bacteria *Escherichia coli* and *Haemophilus influenzae*, as well as eukaryotic organisms such as *Saccharomyces cerevisiae* (yeast), *C. elegans* (flatworm), *Drosophila melanogaster* (fruit fly), *Mus musculus* (mouse), *Rattus norvegicus* (rat), *Fugu rubripes rubripes* (puffer fish), mosquito, and zebrafish. These *comparative genomics* projects identified many novel genes and were of vital importance in the Human Genome Project because mapping the human homologs provided new 'candidate' genes for inherited diseases in humans.

### Functional Genomics

The second major way in which model organisms proved to be invaluable in the Human Genome Project was by providing the means to follow the expression of genes and the function of their protein products in normal development as well as their dysfunction in inherited disorders. This is referred to as **functional genomics**.

### Beyond the Human Genome Project

The goal of functional genomics is to understand the relationship between an organism's genome and its phenotype. There are many different possible approaches. For example the ability to introduce targeted mutations in specific genes allows the production of animal models to study the pathodevelopmental basis for inherited human disorders, as well as serve as a test system for the safety and efficacy of gene therapy and other treatment modalities (p. 207). Functional genomics includes a number of "-omics" such as **transcriptomics** (gene expression), **proteomics** (protein expression), and **metabolomics** (metabolites).

The activity and expression of protein-coding genes is modulated by the **regulome**, a collection of DNA elements that



includes regulatory sequences (promoters, enhancers and silencers) together with regions of chromatin structure and histone modification. The international ENCODE (Encyclopedia of DNA Elements) project aims to identify all the functional elements of genomic DNA, in both coding and non-coding regions. In 2012 the project simultaneously published 30 papers in *Nature*, *Genome Biology* and *Genome Research*. They reported that over 80% of the human genome is involved in the regulation of gene expression and showed enrichment of GWAS SNPs (Chapter 10) within non-coding functional elements.

Understanding the link between gene expression and DNA variation through transcriptome profiling in greater than 40 different tissues from 900 postmortem donors is the focus of the Genotype-Tissue Expression (GTEx) Project. Early results have demonstrated that some variants affect gene expression in a single or restricted set of tissues, whereas other variants can affect gene expression of multiple tissues but to a variable degree across those different tissues.

### Identifying the Genetic Etiology of Monogenic Disorders by Next-Generation Sequencing

This new sequencing technology (described in Chapter 5) has revolutionized the identification of human disease genes. In the last 5 years the number of disease phenotypes with a known molecular basis has increased from 2700 to 4500. Each month more than 10 new disease genes are reported and we anticipate that the genetic etiology of the approximately 25% remaining single-gene disorders will be elucidated during the next few years.

#### Exome Sequencing

The first successful use of next-generation sequencing technology for disease gene identification used the strategy of **exome sequencing** (Figure 4.4). This enabled researchers to identify mutations in the *DHODH* gene as the cause of Miller syndrome. Approximately 164,000 regions encompassing exons and their conserved splice sites (a total of 27 Mb) were sequenced in a pair of affected siblings and probands from two additional families. Non-synonymous variants, splice donor/acceptor, or coding insertion/deletion mutations were identified in nearly 5000 genes in each of the two affected siblings. Filtering these variants against public databases (dbSNP and HapMap) yielded novel variants in less than 500 genes. Analysis of pooled data from the four affected patients revealed just one gene, *DHODH*, which contained two mutated alleles in each of the four individuals.

Before embarking on exome sequencing in an attempt to identify the cause of a monogenic disease, it is important to identify a suitable strategy with regard to pedigree structure, selection of cases for exome sequencing and likely mode of inheritance (Figure 4.5). An extremely successful strategy is the “trio-analysis” approach for the detection of *de novo* heterozygous mutations causing disorders with reduced biological fitness (where patients do not survive to reproductive age or do not reproduce). An affected patient and their unaffected, unrelated parents are sequenced and the variants filtered to identify heterozygous potentially deleterious variants present only in the proband. If parental samples are not available it is possible to use a cohort analysis of unrelated, affected individuals who share a distinctive phenotype to identify heterozygous

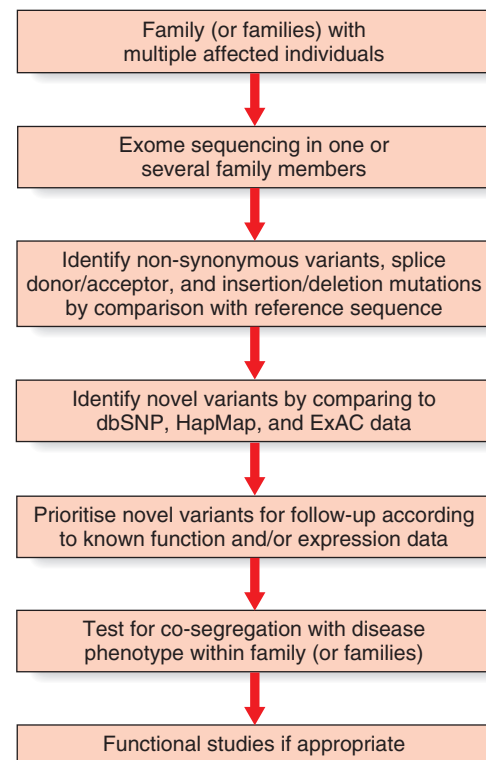


FIGURE 4.4 A strategy for disease gene identification using exome sequencing.

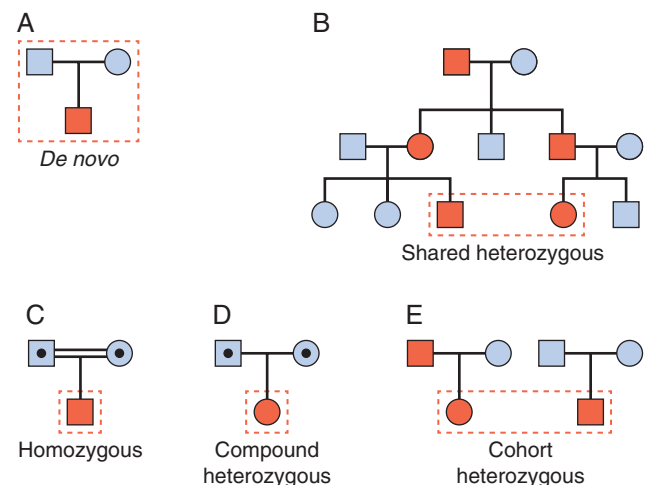


FIGURE 4.5 Strategies for disease gene identification by exome or genome sequencing. The red dashed boxes indicate individuals within pedigrees whose samples are analyzed by exome or genome sequencing. **(A)** Trio analysis of an affected patient and their unrelated, unaffected parents to detect heterozygous *de novo* mutations. **(B)** Linkage approach of sequencing the two most distantly related affected individuals in a dominant pedigree to identify shared heterozygous variants that include the pathogenic mutation. **(C)** Analysis of a proband from a consanguineous pedigree to identify homozygous variants in a gene within a homozygous region. **(D)** Analysis of a proband born to unaffected, unrelated parents to identify compound heterozygous mutations in a single gene. **(E)** Cohort analysis of unrelated, affected individuals who share a distinctive phenotype to identify heterozygous mutations in the same gene.

mutations in the same gene. In a dominant pedigree with multiple affected patients a linkage approach can be employed where the two most distantly related affected individuals are sequenced to identify shared heterozygous variants that include the pathogenic mutation. Given that each individual has approximately 100 heterozygous potentially deleterious protein-coding variants, sequencing two family members separated by four meioses will yield a shortlist of approximately 12 gene variants. Sequencing a single affected individual to identify a recessive disorder caused by compound heterozygous mutations is also possible. For consanguineous pedigrees, sequencing of a single affected person may identify a homozygous mutation in a gene located within a homozygous region. Application of these strategies has led to the identification of hundreds of new disease genes (Table 4.2).

Having selected the most appropriate patients for exome or genome sequencing, the critical next step is to filter the identified variants to leave only a shortlist that includes the causative gene mutation or mutations. This relies upon bioinformatics selection of variants according to functional effect and exclusion of common variants using public databases. Bioinformatics as a specialty has expanded rapidly since the implementation of next-generation sequencing due to both the volume and complexity of data generated.

As the cost of next-generation sequencing falls, sequencing the genome instead of the exome becomes more feasible. Genome sequencing requires less hands-on laboratory preparation time and is able to detect nearly all types of mutations, including intronic mutations, regulatory mutations, and balanced chromosome rearrangements. There is, however, an increased burden from the perspective of data storage and analysis with 3–4 million variants per genome compared to approximately 30,000 variants per exome (Figure 4.6). Whereas our current understanding of the clinical significance of non-coding variants is limited, much research effort is focused in this area.

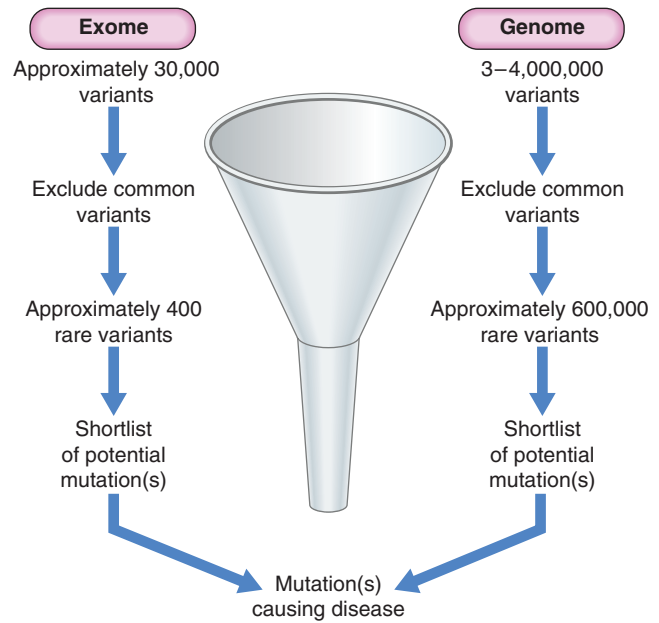


FIGURE 4.6 Filtering variants identified by exome and genome sequencing to identify pathogenic mutations causing rare disease.

**Table 4.2** Strategies for Disease Gene Identification by Exome Sequencing

Strategy	Examples of Disorders with New Disease Genes Identified
Trio analysis to identify <i>de novo</i> heterozygous mutations	Intellectual disability, autism and developmental disorders
Linkage approach of sequencing most distantly related individuals within a dominant pedigree to identify heterozygous mutations	Charcot-Marie-Tooth disease ( <i>DYNC1H1</i> )
Proband sequencing in a consanguineous pedigree to identify homozygous mutations	Oculocutaneous albinism and neutropenia (in a single patient)
Proband sequencing to identify compound heterozygous mutations in an outbred family	Miller syndrome and Sensenbrenner syndrome
Cohort sequencing of affected individuals with a distinctive phenotype	Kabuki syndrome

**FURTHER READING**

Bernstein, B.E., Birney, E., Dunham, I., et al., 2012. An integrated encyclopedia of DNA elements in the human genome. *Nature* 489, 57–74.  
*An overview of the results from the ENCODE project which concluded that >80% of the human genome has a biochemical function in the control of gene expression.*

Kerem, B., Rommens, J.M., Buchanan, J.A., et al., 1989. Identification of the cystic fibrosis gene. *Genetic analysis. Science* 245, 1073–1080.  
*Original paper describing cloning of the cystic fibrosis gene.*

McKusick, V.A., 1998. *Mendelian inheritance in man*, twelfth ed. Johns Hopkins University Press, London.  
*A computerized catalog of the dominant, recessive, and X-linked mendelian traits and disorders in humans with a brief clinical commentary and details of the mutational basis, if known. Also available online, updated regularly.*

Ng, S.B., Buckingham, K.J., Lee, C., et al., 2010. Exome sequencing identifies the cause of a mendelian disorder. *Nat. Genet.* 42, 30–35.  
*The first publication describing the use of next-generation sequencing to elucidate the genetic etiology of Miller syndrome.*

Royer-Pokora, B., Kunkel, L.M., Monaco, A.P., et al., 1985. Cloning the gene for an inherited human disorder—chronic granulomatous disease—on the basis of its chromosomal location. *Nature* 322, 32–38.  
*Original paper describing the identification of a disease gene through contiguous chromosome deletions.*

Strachan, T., Read, A.P., 2011. *Human molecular genetics*, fourth ed. Garland Science, London.  
*A comprehensive textbook of all aspects of molecular and cellular biology as related to inherited disease in humans.*

Sulston, J., 2002. *The common thread: a story of science, politics, ethics and the human genome.* Joseph Henry Press, London.  
*A personal account of the human genome sequencing project by the man who led the UK team of scientists.*

## ELEMENTS

- 1 Position-independent methods for the identification of monogenic disorders include functional cloning to identify genes from knowledge of the protein sequence and the use of animal models.
- 2 Positional cloning describes the identification of a gene on the basis of its location in the human genome. Chromosome abnormalities may assist this approach by highlighting particular chromosome regions of interest. Genetic databases with human genome sequence data now make it possible to identify disease genes *in silico*.
- 3 Confirmation that a specific gene is responsible for a particular inherited disorder can be obtained by tissue and developmental expression studies, *in vitro* cell culture studies, or the introduction and analysis of mutations in a homologous gene in another species. As a consequence, the 'anatomy of the human genome' is continually being unraveled.
- 4 One of the goals of the Human Genome Project was to sequence the human genome. The sequencing was completed by an international consortium in 2003, and has greatly facilitated the identification of human disease genes.
- 5 Next-generation sequencing has hugely accelerated the pace of new disease gene discovery and the genetic basis of approximately 75% of an estimated 6000 monogenic disorders is now known.
- 6 Research efforts are now focused on understanding the role of non-coding DNA in the control of gene expression and how this contributes to human disease.

## Chapter 5

# Laboratory Techniques for Diagnosis of Monogenic Disorders

In the history of medical genetics, the ‘chromosome breakthrough’ in the mid-1950s was revolutionary. In the past 4 decades, DNA technology has had a profound effect, not only in medical genetics but also in many areas of biological science (Box 5.1). The seminal developments in the field are summarized in Table 5.1. One of the most revolutionary developments is the technique first developed in the mid-1980s known as the **polymerase chain reaction** or **PCR** which can be used to produce vast quantities of a target DNA fragment provided that the DNA sequence of that region is known.

### PCR (Polymerase Chain Reaction)

DNA sequence information is used to design two oligonucleotide primers (**amplimers**) of approximately 20 bp in length complementary to the DNA sequences flanking the target DNA fragment. The first step is to denature the double-stranded DNA by heating. The primers then bind to the complementary DNA sequences of the single-stranded DNA templates. DNA polymerase extends the primer DNA in the presence of the deoxynucleotide triphosphates (dATP, dCTP, dGTP, and dTTP) to synthesize the complementary DNA sequence. Subsequent heat denaturation of the double-stranded DNA, followed by annealing of the same primer sequences to the resulting single-stranded DNA, will result in the synthesis of further copies of the target DNA. Some 30–35 successive repeated cycles result in more than 1 million copies (**amplicons**) of the DNA target, sufficient for direct visualization by ultraviolet fluorescence after ethidium bromide staining, without the need to use indirect detection techniques (Figure 5.1). PCR is mostly used to amplify DNA fragments up to 1 kb, although long-range PCR allows the amplification of larger DNA fragments of up to 20 kb to 30 kb.

#### Box 5.1 Applications of DNA Technology

- Gene structure/mapping/function
- Population genetics
- Clinical genetics
  - Preimplantation genetic diagnosis
  - Prenatal diagnosis
  - Presymptomatic diagnosis
  - Carrier detection
- Diagnosis and pathogenesis of disease
  - Genetic
  - Acquired—*infective, malignant*
- Biosynthesis (e.g., insulin, growth hormone, interferon, immunization)
- Treatment of genetic disease
- Gene therapy
- Agriculture (e.g., nitrogen fixation)

PCR allows analysis of DNA from any cellular source containing nuclei; in addition to blood, this can include less invasive samples, such as saliva, buccal scrapings, or pathological archival material. It is also possible to start with quantities of DNA as small as that from a single cell, as is the case in pre-implantation genetic diagnosis (p. 313). Great care has to be taken with PCR, however, because DNA from a contaminating extraneous source, such as desquamated skin from a laboratory worker, will also be amplified. This can lead to false-positive results unless the appropriate control studies are used to detect this possible source of error.

Another advantage of PCR is the rapid turnaround time of samples for analysis. Use of the heat-stable *Taq* DNA polymerase isolated from the bacterium *Thermophilus aquaticus*, which grows naturally in hot springs, generates PCR products in a matter of hours. Real-time PCR machines have reduced this time to less than 1 hour, and fluorescence technology is used to monitor the generation of PCR products during each cycle, thus eliminating the need for gel electrophoresis.

### Application of DNA Sequence Polymorphisms

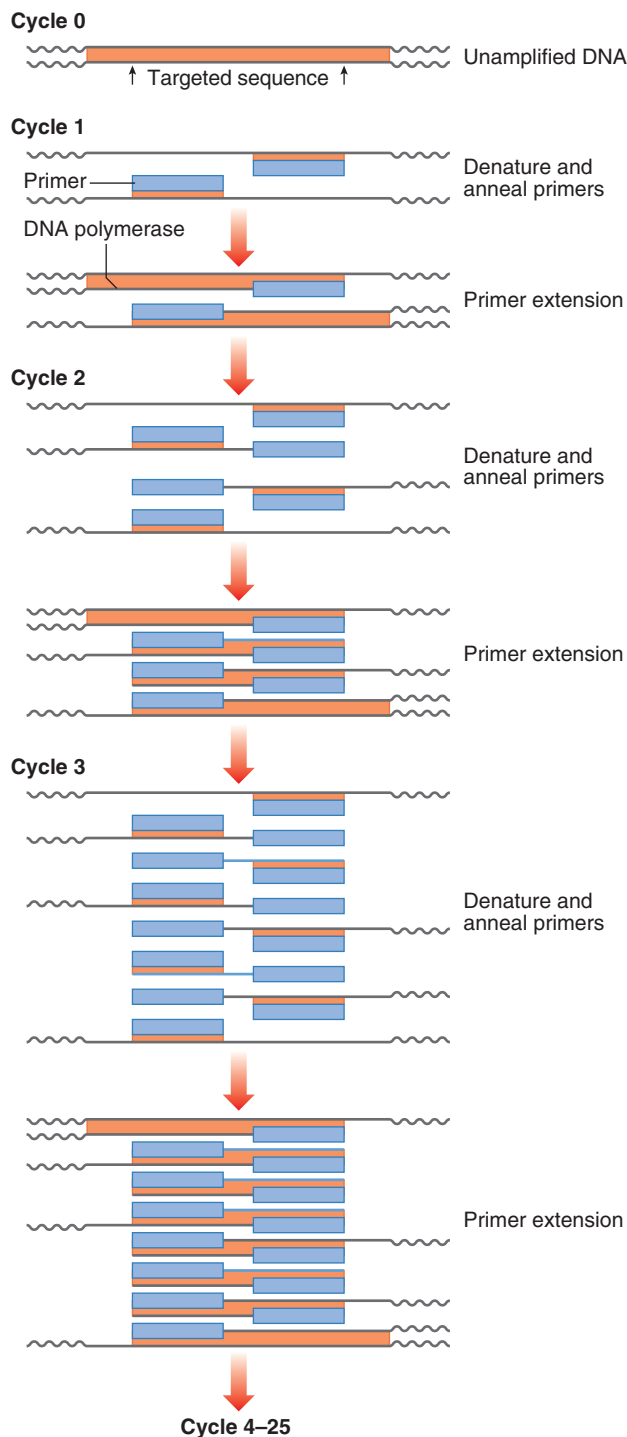
There is an enormous amount of DNA sequence variation in the human genome (p. 9). Two main types, SNPs and hyper-variable tandem repeat DNA length polymorphisms, are predominantly used in genetic analysis.

#### Single Nucleotide Polymorphisms

Approximately 1 in 1000 bases within the human genome shows variation. SNPs are most frequently biallelic and occur

**Table 5.1** Development of DNA Technology

Decade	Development	Examples of Application
1980s	Recombinant DNA technology, Southern blot, and Sanger sequencing	Recombinant erythropoietin (1987), DNA fingerprinting (1984), and DNA sequence of Epstein–Barr virus genome (1984)
1990s	Polymerase chain reaction (PCR)	Diagnosis of genetic disorders
2000s	Capillary sequencing and microarray technology	Human genome sequence (2003)
2010s	Next-generation sequencing	First acute myeloid leukemia (AML) cancer genome sequenced (2008) Human genome sequenced at a cost of approx. \$1000 (2014)



**FIGURE 5.1** Diagram of the polymerase chain reaction showing serial denaturation of DNA, primer annealing, and extension with doubling of the target DNA fragment numbers in each cycle.

in coding and non-coding regions. An early way of using SNPs as genetic markers was the analysis of **restriction fragment length polymorphisms**, or **RFLPs**. In the 1970s, it was recognized that certain microbes contain enzymes that cleave double-stranded DNA in or near a particular sequence of nucleotides. These enzymes restrict the entry of foreign DNA into bacterial cells and were therefore called **restriction enzymes**. They recognize a palindromic nucleotide sequence of

**Table 5.2** Some Examples of Restriction Endonucleases With Their Nucleotide Recognition Sequence and Cleavage Sites

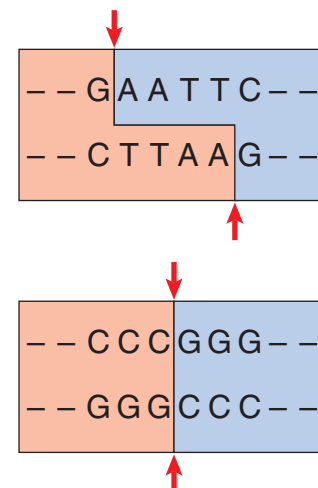
Enzyme	Organism	Cleavage Site	
		5'	3'
BamHI	<i>Bacillus amyloliquefaciens</i> H	G · G A T C C	
EcoRI	<i>Escherichia coli</i> RY 13	G · A A T T C	
HaeIII	<i>Haemophilus aegyptius</i>	G G · C C	
HindIII	<i>Haemophilus influenzae</i> Rd	A · A G C T T	
HpaI	<i>Haemophilus parainfluenzae</i>	G T T · A A C	
PstI	<i>Providencia stuartii</i>	C T G C A · G	
SmaI	<i>Serratia marcescens</i>	C C C · G G G G	
SalI	<i>Streptomyces albus</i> G	G · T C G A C	

DNA of between four and eight nucleotides in length (i.e., the same sequence of nucleotides occurring on the two complementary DNA strands when read in one direction of polarity, e.g., 5' to 3') (Table 5.2). The longer the nucleotide recognition sequence of the restriction enzyme, the less frequently that particular nucleotide sequence will occur by chance and therefore the larger the average size of the DNA fragments generated.

More than 3000 different restriction enzymes have been isolated from various bacterial organisms. Restriction endonucleases are named according to the organism from which they are derived (e.g., *EcoRI* is from *Escherichia coli* and was the first restriction enzyme isolated from that organism).

The complementary pairing of bases in the DNA molecule means that cleavage of double-stranded DNA by a restriction endonuclease always creates double-stranded breaks, which, depending on the cleavage points of the particular restriction enzyme used, results in either a staggered or a blunt end (Figure 5.2). Digestion of DNA from a specific source with a particular restriction enzyme will produce the same reproducible collection of DNA fragments each time the process is carried out.

If a SNP lies within the recognition sequence of a restriction enzyme, the DNA fragments produced by that restriction enzyme will be of different lengths in different people. This can be recognized by the altered mobility of the restriction fragments on gel electrophoresis, so-called **RFLPs**. Early



**FIGURE 5.2** The staggered and blunt ends generated by restriction digest of double-stranded DNA by *EcoRI* and *SmaI*. Sites of cleavage of the DNA strands are indicated by arrows.

genetic mapping studies used Southern blotting to detect RFLPs, but current technology enables the detection of any SNP. DNA microarrays have led to the creation of a dense SNP map of the human genome and assist genome searches for linkage studies in mapping single-gene disorders (see Chapter 4) and association studies in common diseases.

### Variable Number Tandem Repeats

Variable number tandem repeats (VNTRs) are highly polymorphic and are due to the presence of variable numbers of tandem repeats of a short DNA sequence that have been shown to be inherited in a mendelian co-dominant fashion (p. 69). The advantage of using VNTRs over SNPs is the large number of alleles for each VNTR compared with SNPs, which are mostly biallelic.

### Minisatellites

Alec Jeffreys identified a short 10-bp to 15-bp 'core' sequence with homology to many highly variable loci spread throughout the human genome (p. 13). Using a probe containing tandem repeats of this core sequence, a pattern of hypervariable DNA fragments could be identified. The multiple variable-size repeat sequences identified by the core sequence are known as **minisatellites**. These minisatellites are highly polymorphic, and a profile unique to an individual (unless they have an identical twin!) is described as a **DNA fingerprint**. The technique of DNA fingerprinting is used widely in paternity testing and for forensic purposes.

### Microsatellites

The human genome contains some 50,000 to 100,000 blocks of a variable number of tandem repeats of the dinucleotide CA:GT, so-called CA repeats or **microsatellites** (p. 13). The difference in the number of CA repeats at any one site between

individuals is highly polymorphic and these repeats have been shown to be inherited in a mendelian co-dominant manner. In addition, highly polymorphic trinucleotide and tetranucleotide repeats have been identified, and can be used in a similar way (Figure 5.3). These microsatellites can be analyzed by PCR and the use of fluorescent detection systems allows relatively high-throughput analysis. Consequently, microsatellite analysis has replaced DNA fingerprinting for paternity testing and establishing zygosity.

### Clinical Applications of Gene Tracking

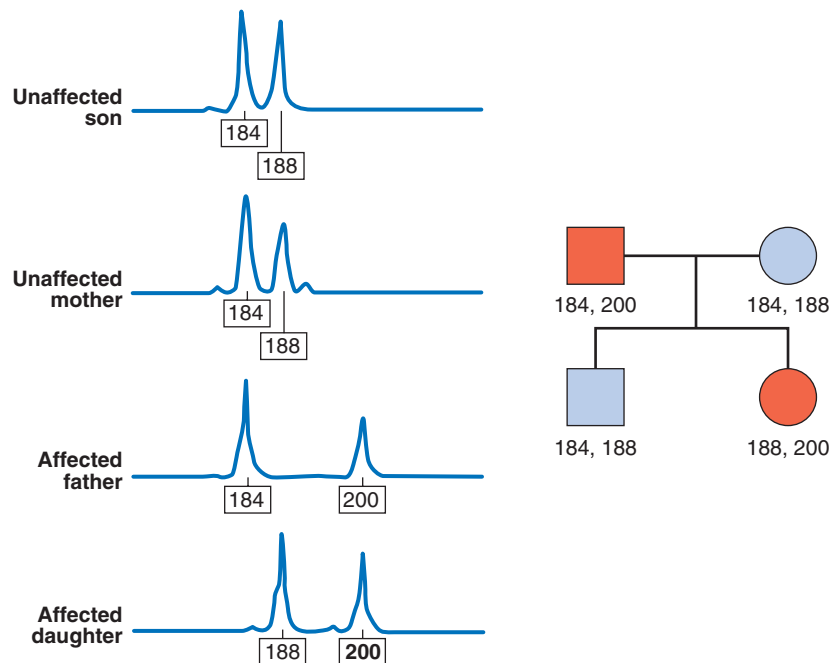
If a gene has been mapped by linkage studies but not identified, it is possible to use the linked markers to 'track' the mutant haplotype within a family. This approach may also be used for known genes where a familial mutation has not been found. Closely flanking or intragenic microsatellites are used most commonly, because of the lower likelihood of finding informative SNPs within families. Figure 5.4 illustrates a family in which gene tracking has been used to determine carrier risk in the absence of a known mutation. There are some pitfalls associated with this method: recombination between the microsatellite and the gene may give an incorrect risk estimate, and the possibility of genetic heterogeneity (where mutations in more than one gene cause a disease) should be borne in mind.

### Nucleic Acid Hybridization Techniques

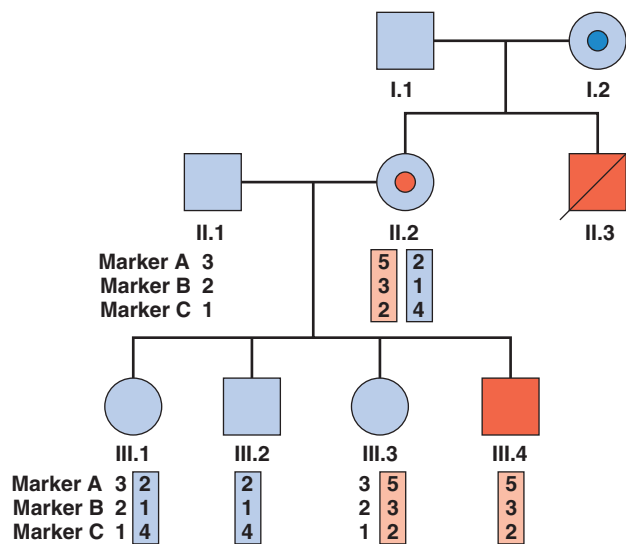
Many methods of DNA analysis involve the use of nucleic acid probes and the process of nucleic acid hybridization.

### Nucleic Acid Probes

Nucleic acid probes are usually single-stranded DNA sequences that have been radioactively or non-radioactively labeled and



**FIGURE 5.3** Analysis of a tetranucleotide microsatellite marker in a family with a dominant disorder. *Genotyper* software was used to label the peaks with the size of the polymerase chain reaction (PCR) products. The 200-bp allele is segregating with the disorder in the affected members of the family. (Courtesy M. Owens, Department of Molecular Genetics, Royal Devon and Exeter Hospital, Exeter, UK.)



**FIGURE 5.4** Gene tracking in a family with Duchenne muscular dystrophy where no mutation has been found in the affected proband, III.4. Analysis of markers A, B, and C has enabled the construction of haplotypes; the affected haplotype is shown by an orange box. Both of the proband's sisters were at 50% prior risk of being carriers. Gene tracking shows that III.1 has inherited the low-risk haplotype and is unlikely to be a carrier, but III.3 has inherited the high-risk haplotype and is therefore likely to be a carrier of Duchenne muscular dystrophy. The risk of recombination should not be forgotten.

can be used to detect DNA or RNA fragments with sequence homology. DNA probes can come from a variety of sources, including random genomic DNA sequences, specific genes, cDNA sequences or oligonucleotide DNA sequences produced synthetically based on knowledge of the protein amino-acid sequence. A DNA probe can be labeled by a variety of processes, including isotopic labeling with  $^{32}\text{P}$  and non-isotopic methods using modified nucleotides containing fluorophores (e.g., fluorescein or rhodamine). Hybridization of a radioactively labeled DNA probe with cDNA sequences on a nitrocellulose filter can be detected by autoradiography, whereas DNA fragments that are fluorescently labeled can be detected by exposure to the appropriate wavelength of light, for example fluorescent in-situ hybridization (p. 27).

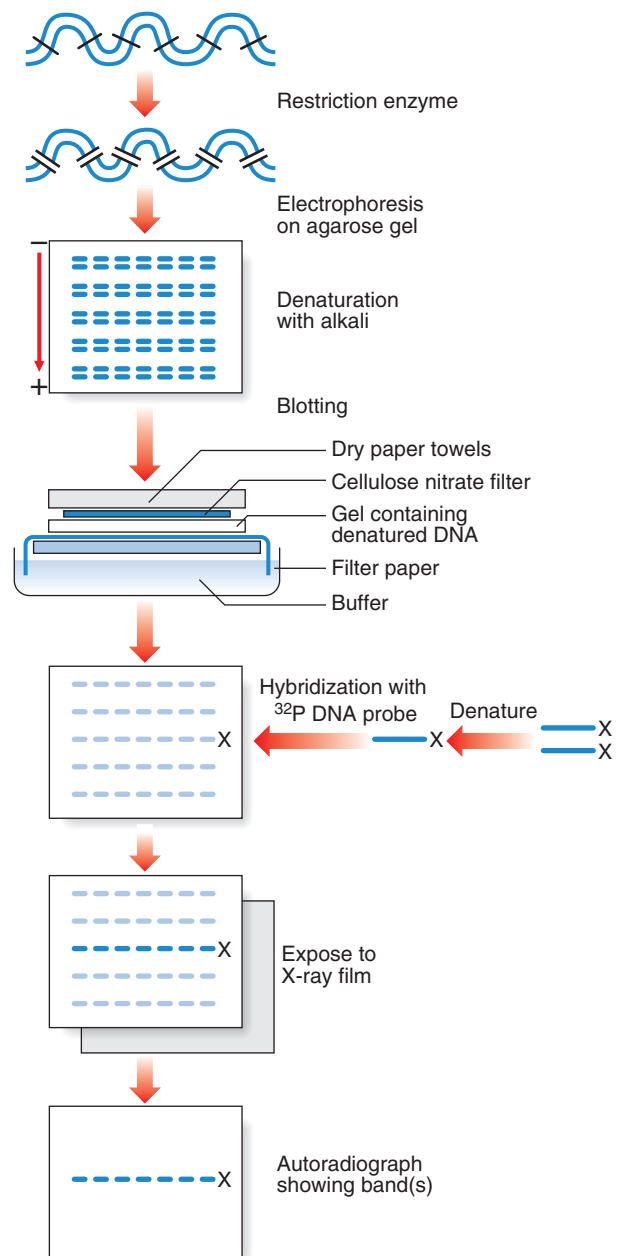
### Nucleic Acid Hybridization

Nucleic acid hybridization involves mixing DNA from two sources that have been denatured by heat or alkali to make them single stranded and then, under the appropriate conditions, allowing complementary base pairing of homologous sequences. If one of the DNA sources has been labeled in some way (i.e., is a DNA probe), this allows identification of specific DNA sequences in the other source.

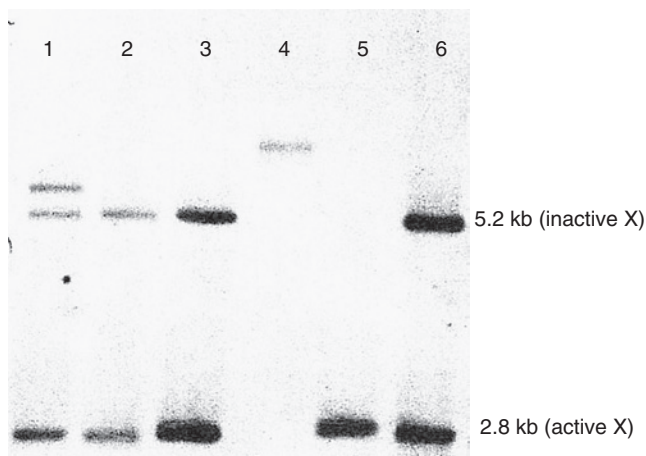
### Southern Blotting

Southern blotting, named after Edwin Southern (who developed the technique), involves digesting DNA by a restriction enzyme that is then subjected to electrophoresis on an agarose gel. This separates the DNA or restriction fragments by size, the smaller fragments migrating faster than the larger ones. The DNA fragments in the gel are then denatured with alkali, making them single stranded. A 'permanent' copy of these single-stranded fragments is made by transferring them on to

a nitrocellulose filter that binds the single-stranded DNA, the so-called **Southern blot**. A particular target DNA fragment of interest from the collection on the filter can be visualized by adding a single-stranded  $^{32}\text{P}$  radioactively labeled DNA probe that will hybridize with homologous DNA fragments in the Southern blot, which can then be detected by autoradiography (Figure 5.5). Non-radioactive Southern blotting techniques have been developed with the DNA probe labeled with digoxigenin and detected by chemiluminescence. This approach is safer and generates results more rapidly. An example of the use of Southern blotting for clinical diagnostic fragile X testing in patients is shown in Figure 5.6.



**FIGURE 5.5** Diagram of the Southern blot technique showing size fractionation of the DNA fragments by gel electrophoresis, denaturation of the double-stranded DNA to become single stranded, and transfer to a nitrocellulose filter that is hybridized with a  $^{32}\text{P}$  radioactively labeled DNA probe.



**FIGURE 5.6** Southern blot to detect methylation of the *FMR1* promoter in patients with fragile X. DNA digested with *EcoRI* and the methylation sensitive enzyme *Bst* Z1 was probed with Ox1.9, which hybridizes to a CpG island within the *FMR1* promoter. Lanes 1–6 show samples from Patient 1, a female with a methylated expansion, Patients 2, 3, and 6 who are unaffected females, Patient 4 who is an affected male and Patient 5 who is an unaffected male. (Courtesy A. Gardner, formerly at the Bristol Genetics Laboratory, Southmead Hospital, Bristol, UK.)

### Northern Blotting

Northern blotting differs from Southern blotting by the use of mRNA as the target nucleic acid in the same procedure; mRNA is very unstable because of intrinsic cellular ribonucleases. Use of ribonuclease inhibitors allows isolation of mRNA that, if run on an electrophoretic gel, can be transferred to a filter. Hybridizing the blot with a DNA probe allows determination of the size and quantity of the mRNA transcript, a so-called **Northern blot**. With the advent of real-time reverse transcriptase PCR, microarray technology for gene expression studies and next generation RNA sequencing, Northern blotting is now rarely used.

### DNA Microarrays

DNA microarrays are based on the same principle of hybridization but on a miniaturized scale, which allows simultaneous

analysis of several million targets. Short, fluorescently labeled oligonucleotides attached to a glass microscope slide can be used to detect hybridization of target DNA under appropriate conditions. The color pattern of the microarray is then analyzed automatically by computer. Four classes of application have been described: (1) expression studies to look at the differential expression of thousands of genes at the mRNA level; (2) analysis of DNA variation for mutation detection and single nucleotide polymorphism (SNP) typing; (3) testing for genomic gains and losses by array comparative genomic hybridization (CGH); and (4) a combination of the latter two, SNP-CGH, which allows the detection of copy-neutral genetic anomalies such as uniparental disomy (p. 77).

### Array CGH

Array CGH involves the hybridization of fluorescently labelled patient and reference DNA to large numbers of DNA sequences bound to glass slides (Figure 5.7). The DNA target sequences are oligonucleotides (up to 1 million) spotted onto the microscope slides using robotics to create a microarray in which each DNA target has a unique location. Following hybridization and washing to remove unbound DNA, the relative levels of fluorescence are measured using computer software.

Array CGH is able to detect copy number changes at a level of 5–10 kb DNA. It is faster and more sensitive than conventional metaphase analysis for the identification of constitutional rearrangements (but cannot detect balanced translocations or inversions). Array CGH is the first-line test in the investigation of patients with severe developmental delay/learning difficulties and/or congenital abnormalities and is now being used in the prenatal setting when abnormalities are detected by ultrasound scanning.

### Mutation Detection

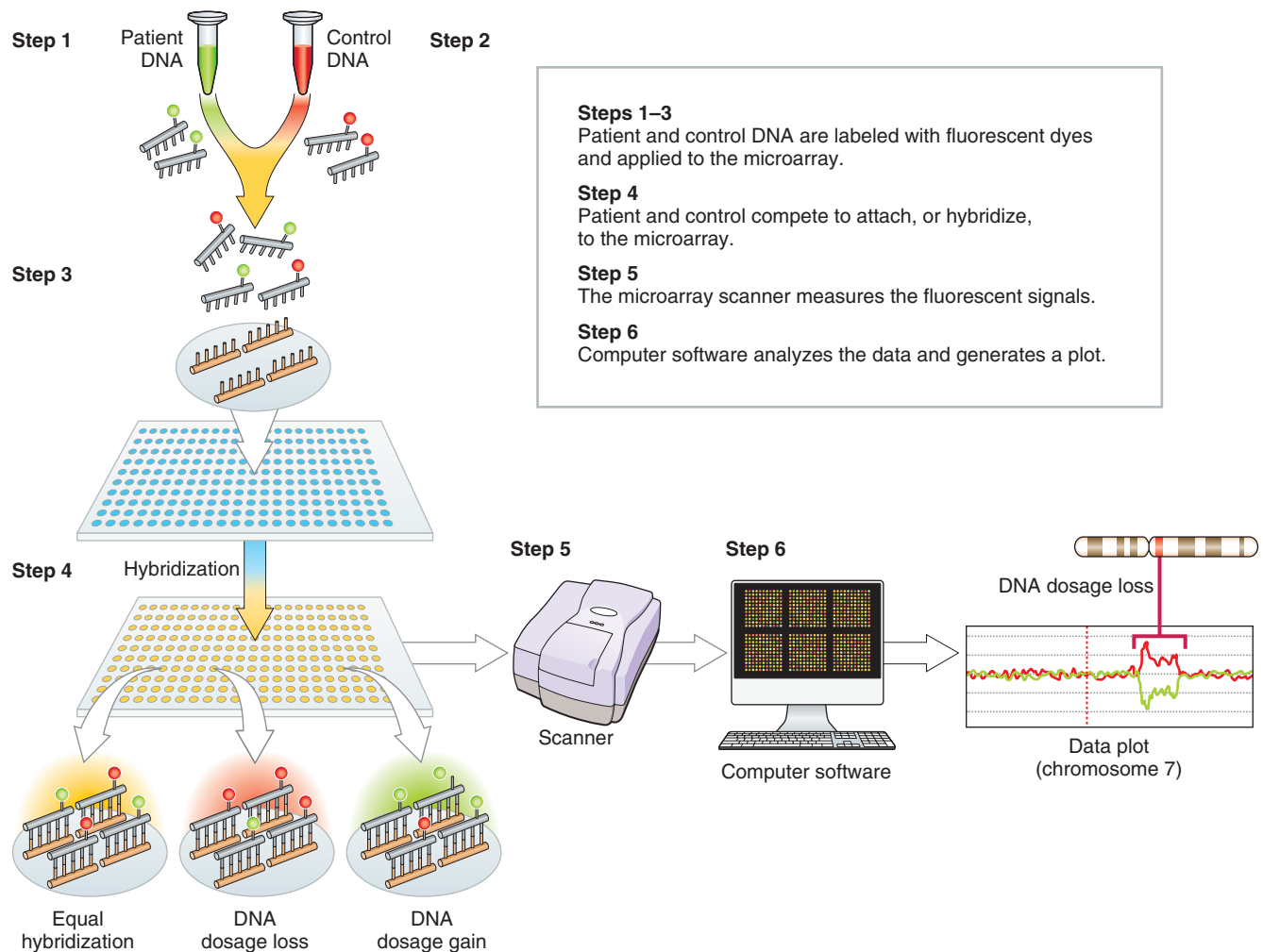
The choice of method depends primarily on whether the test is for a known sequence change or to identify the presence of any mutation within a particular gene. A number of techniques can be used to screen for mutations that differ in their ease of use and reliability (Table 5.3). Some of the most common techniques in current use are described in the following section.

**Table 5.3** Methods for Detecting Mutations

Method	Known/Unknown Mutations	Example	Advantages/Disadvantages
Southern blot	Known (or unknown rearrangement)	Trinucleotide expansions in fragile X and myotonic dystrophy	Laborious
Sizing of PCR products	Known	p.Phe508del <i>CFTR</i> mutation; trinucleotide expansions in <i>HTT</i> and <i>SCA</i> genes	Simple, cheap
ARMS-PCR	Known	<i>CFTR</i> mutations	Multiplex possible
Oligonucleotide ligation	Known	<i>CFTR</i> mutations	Multiplex possible
Real-time PCR	Known	Factor V Leiden	Expensive equipment
Droplet digital PCR	Known	Any gene	Expensive equipment
Sanger sequencing	Known or unknown	Any gene	Gold standard
Pyrosequencing	Known or unknown	Any gene	Expensive equipment
Next-generation sequencing	Known or unknown	Any gene	Expensive equipment, enormous capacity but vast amount of data to analyze and interpretation of novel variants can be difficult

ARMS, Amplification-refractory mutation system; PCR, polymerase chain reaction.





**FIGURE 5.7** Diagram of array CGH (comparative genomic hybridization) to detect copy number changes across the genome to a resolution of 5–10 kb.

### PCR-Based Methods

Many PCR-based mutation detection methods have been developed over the past 3 decades to detect known mutations.

#### Size Analysis of PCR Products

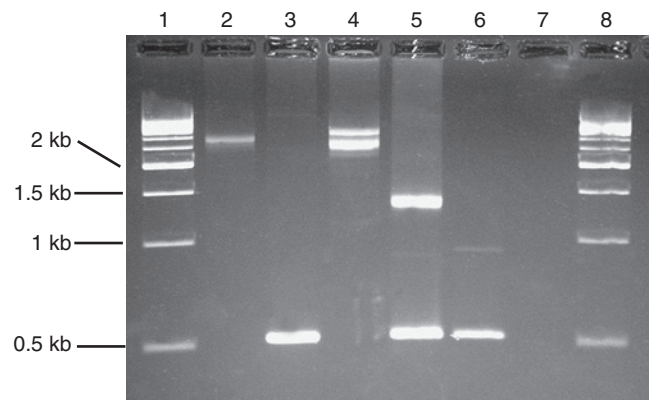
Deletion or insertion mutations can sometimes be detected simply by determining the size of a PCR product. For example, the most common mutation that causes cystic fibrosis, p.Phe508del, is a 3-bp deletion that can be detected on a polyacrylamide gel. Some trinucleotide repeat expansion mutations can be amplified by PCR (Figure 5.8).

#### Restriction Fragment Length Polymorphism

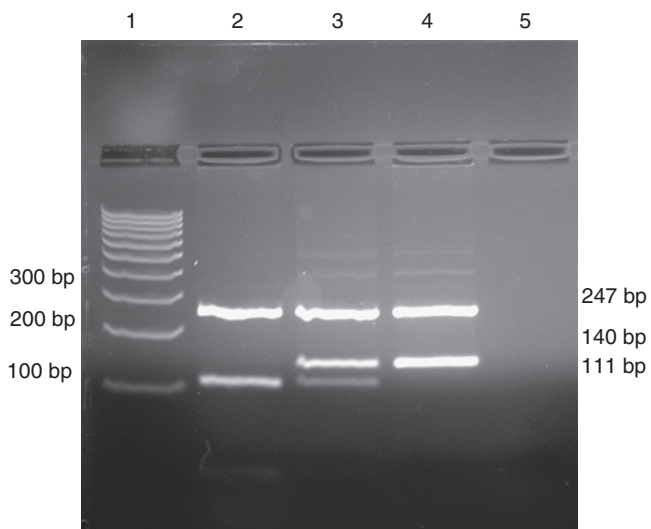
If a base substitution creates or abolishes the recognition site of a restriction enzyme, it is possible to test for the mutation by digesting a PCR product with the appropriate enzyme and separating the products by electrophoresis (Figure 5.9).

#### Amplification-Refractory Mutation System (ARMS) PCR

Allele-specific PCR uses primers specific for the normal and mutant sequences. The most common design is a two-tube assay with normal and mutant primers in separate reactions together with control primers to ensure that the PCR reaction



**FIGURE 5.8** Amplification of the GAA repeat expansion mutation by polymerase chain reaction (PCR) to test for Friedreich ataxia. Products are stained with ethidium bromide and electrophoresed on a 1.5% agarose gel. Lanes 1 and 8 show 500-bp ladder-size standards, Lanes 2 and 4 show patients with homozygous expansions, Lanes 3 and 6 show unaffected controls, Lane 5 shows a heterozygous expansion carrier, and Lane 7 is the negative control. (Courtesy K. Thomson, formerly at the Department of Molecular Genetics, Royal Devon and Exeter Hospital, Exeter, UK.)

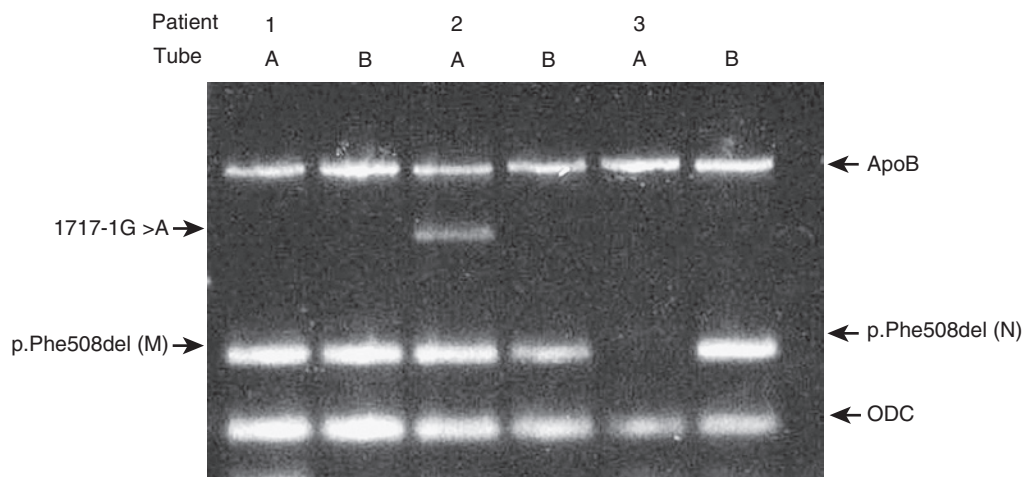


**FIGURE 5.9** Detection of the *HFE* gene mutation C282Y by restriction fragment length polymorphisms (RFLP). The normal 387-bp polymerase chain reaction (PCR) product is digested with *RsaI* to give products of 247 bp and 140 bp. The C282Y mutation creates an additional recognition site for *RsaI*, giving products of 247 bp, 111 bp, and 29 bp. Lane 1 shows a 100-bp ladder-size standard. Lanes 2–4 show patients homozygous, heterozygous, and normal for the C282Y mutation, respectively. Lane 5 is the negative control. (Courtesy N. Goodman, Department of Molecular Genetics, Royal Devon and Exeter Hospital, Exeter, UK.)

has worked. An example of a multiplex ARMS assay to detect 12 different cystic fibrosis mutations is shown in [Figure 5.10](#).

### Oligonucleotide Ligation Assay

A pair of oligonucleotides is designed to anneal to adjacent sequences within a PCR product. If the pair is perfectly hybridized, they can be joined by DNA ligase. Oligonucleotides complementary to the normal and mutant sequences are differentially labeled and the products identified by computer software ([Figure 5.11](#)).



**FIGURE 5.10** Detection of *CFTR* mutations by two-tube amplification-refractory mutation system (ARMS)-polymerase chain reaction (PCR). Patient 1 is heterozygous for  $\Delta F508$  (p.Phe508del). Patient 2 is a compound heterozygote for p.Phe508del and c.1717-1G > A. Patient 3 is homozygous normal for the 12 mutations tested. Primers for two internal controls (ApoB and ODC) are included in each tube.

### Real-Time PCR

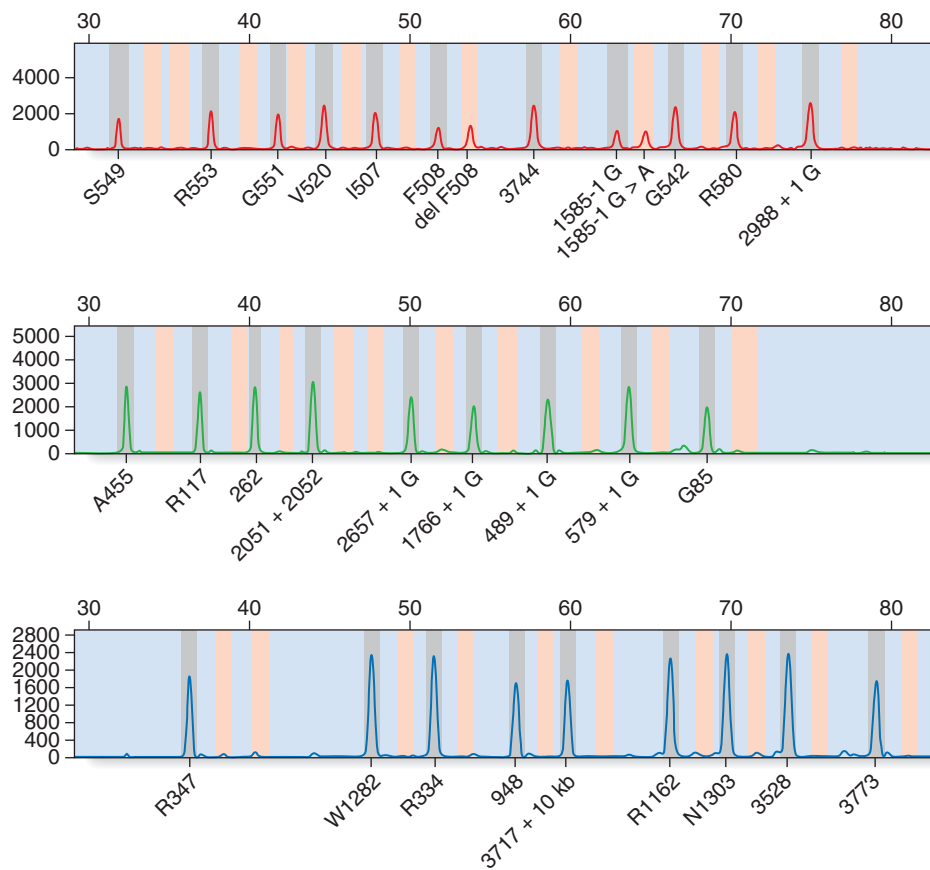
There are multiple hardware platforms for real-time PCR and 'fast' versions that can complete a PCR reaction in less than 30 minutes. TaqMan and LightCycler use fluorescence technology to detect mutations by allelic discrimination of PCR products. [Figure 5.12](#) illustrates the factor V Leiden mutation detected by TaqMan methodology.

Real-time PCR platforms are very popular in clinical microbiology laboratories where an array of commercial kits has been developed to provide rapid testing for many different viral infections. PCR can be used to detect the presence of DNA sequences specific to a particular infectious organism before conventional evidence such as an antibody response or the results of cultures is available. Real-time PCR techniques generate rapid results, with some test results being available within 1 hour of a sample being taken. This is particularly useful in the fight against methicillin-resistant *Staphylococcus aureus* (MRSA), as patients can be rapidly tested on admission to hospital. Anyone found to be MRSA-positive can be isolated to minimize the risk of infection to other patients.

PCR may assist in the diagnosis of lymphomas and leukemias by identifying translocations, for example t(9;22), which is characteristic of chronic myeloid leukemia (CML). The extreme sensitivity of PCR means that minimal residual disease may be detected after treatment for these disorders, and early indication of impending relapse will inform treatment options.

### Droplet Digital PCR

This technique involves PCR performed within thousands of nanoliter-sized droplets to achieve highly precise, absolute nucleic acid quantification. A genomic DNA sample is diluted to incorporate either one molecule or zero DNA in each droplet and mixed with PCR primers, TaqMan allelic discrimination probes (as per conventional real-time PCR) and reagents. After PCR amplification the fluorescence is measured in each droplet and the droplets counted to measure the number with a signal from either the normal or mutant allele. This provides an extremely sensitive method for identifying very low levels of mutation such as mosaic or acquired mutations, or paternally inherited mutations in cell free fetal DNA samples.



**FIGURE 5.11** Detection of *CFTR* mutations using an oligonucleotide ligation assay. Multiplex polymerase chain reaction (PCR) amplifies 15 exons of the *CFTR* gene. Oligonucleotides are designed to anneal to the PCR products such that two oligonucleotides anneal to adjacent sequences for each mutation and are then joined by ligation. The 32 mutations (at 29 positions) are discriminated using a combination of size and differently colored fluorescent labels. This patient is a compound heterozygote for the  $\Delta F508$  (p.Phe508del; c.1521\_1523delCTT) and c.1585-1G > A mutations. Gray bars indicate the normal alleles and orange bars indicate the mutant alleles. (Courtesy Karen Stals, Department of Molecular Genetics, Royal Devon and Exeter Hospital, Exeter, UK.)

## Sequencing-Based Methods

Sequencing methods are the most frequently used technique for mutation ‘screening’ where a patient is suspected of having a mutation within a specific gene or genes, but the disease could be caused by many different mutations within that gene (or genes).

### Sanger Sequencing

The ‘gold standard’ method of mutation screening is DNA sequencing using the dideoxy chain termination method developed in the 1970s by Fred Sanger. This method originally employed radioactive labeling with manual interpretation of data. The use of fluorescent labels detected by computerized laser systems has improved ease of use and increased throughput and accuracy. Today’s capillary sequencers can sequence approximately 1 Mb (1 million bases) per day.

Dideoxy sequencing involves using a single-stranded DNA template (e.g., denatured PCR products) to synthesize new complementary strands using a DNA polymerase and an appropriate oligonucleotide primer. In addition to the four normal deoxynucleotides, a proportion of each of the four respective dideoxynucleotides is included, each labeled with a different fluorescent dye. The dideoxynucleotides lack a hydroxyl group at the 3’ carbon position; this prevents

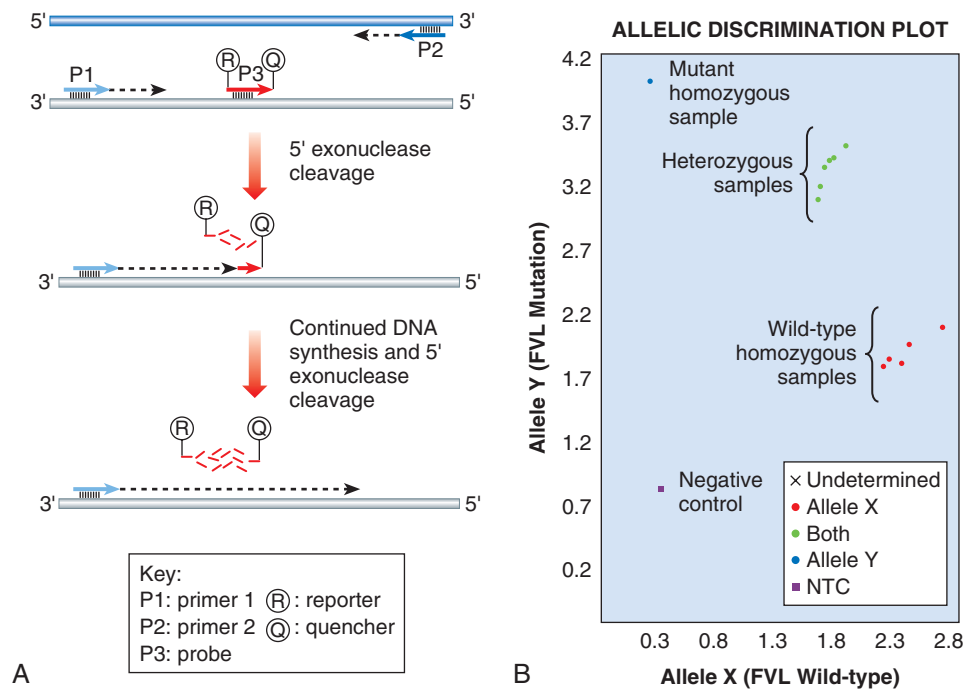
phosphodiester bonding, resulting in each reaction container consisting of a mixture of DNA fragments of different lengths that terminate in their respective dideoxynucleotide, owing to chain termination occurring at random in each reaction mixture at the respective nucleotide. When the reaction products are separated by capillary electrophoresis, a ladder of DNA sequences of differing lengths is produced. The DNA sequence complementary to the single-stranded DNA template is generated by the computer software and the position of a mutation may be highlighted with an appropriate software package (Figure 5.13).

### Pyrosequencing

Pyrosequencing uses sequencing by synthesis approach in which modified nucleotides are added and removed one at a time, with chemiluminescent signals produced after the addition of each nucleotide. This technology generates quantitative sequence data rapidly and an example of its application in the identification of *KRAS* mutations in patients with colorectal cancer is shown in Figure 5.14.

### Next-Generation Sequencing

The demand for low-cost sequencing has driven the development of high-throughput sequencing technologies that produce millions of sequences at once. Next (or second) generation



**FIGURE 5.12** Real-time polymerase chain reaction (PCR) to detect the factor V Leiden mutation. **A**, TaqMan technique. The sequence encompassing the mutation is amplified by PCR primers, P1 and P2. A probe, P3, specific to the mutation is labelled with two fluorophores. A reporter fluorophore, R, is attached to the 5' end of the probe and a quencher fluorophore, Q, is attached to the 3' end. During the PCR reaction, the 5' exonuclease activity of the polymerase enzyme progressively degrades the probe, separating the reporter and quencher dyes, which results in fluorescent signal from the reporter fluorophore. **B**, TaqMan genotyping plot. Each sample is analyzed with two probes, one specific for the wild-type and one for the mutation. The strength of fluorescence from each probe is plotted on a graph (wild-type on X-axis, mutant on Y-axis). Each sample is represented by a single point. The samples fall into three clusters representing the possible genotypes; homozygous wild-type, homozygous mutant or heterozygous. (Courtesy Dr. E. Young, formerly of the Department of Molecular Genetics, Royal Devon and Exeter Hospital, Exeter, UK.)

'clonal' sequencers use an in vitro cloning step to amplify individual DNA molecules by emulsion or bridge PCR (Figure 5.15). The cloned DNA molecules are then sequenced in parallel, either by using sequencing by synthesis or sequencing by ligation approach where incorporated fluorescent bases are detected by laser scanning. The sequence reads are relatively short (100–250 bp) and need to be aligned to a reference sequence in order to identify variants that may be causative of disease (Figure 5.16). A comparison with Sanger sequencing is shown in Table 5.4 and examples of mutations identified by next generation sequencing is shown in Figure 5.16. Another sequencing by synthesis technology utilizes **ion semiconductor sequencing** based on the detection of hydrogen ions that are released during the polymerization of DNA. So-called 'third-generation' sequencers generate long sequence reads (kilobases in length) from single molecules in real-time due to their extremely

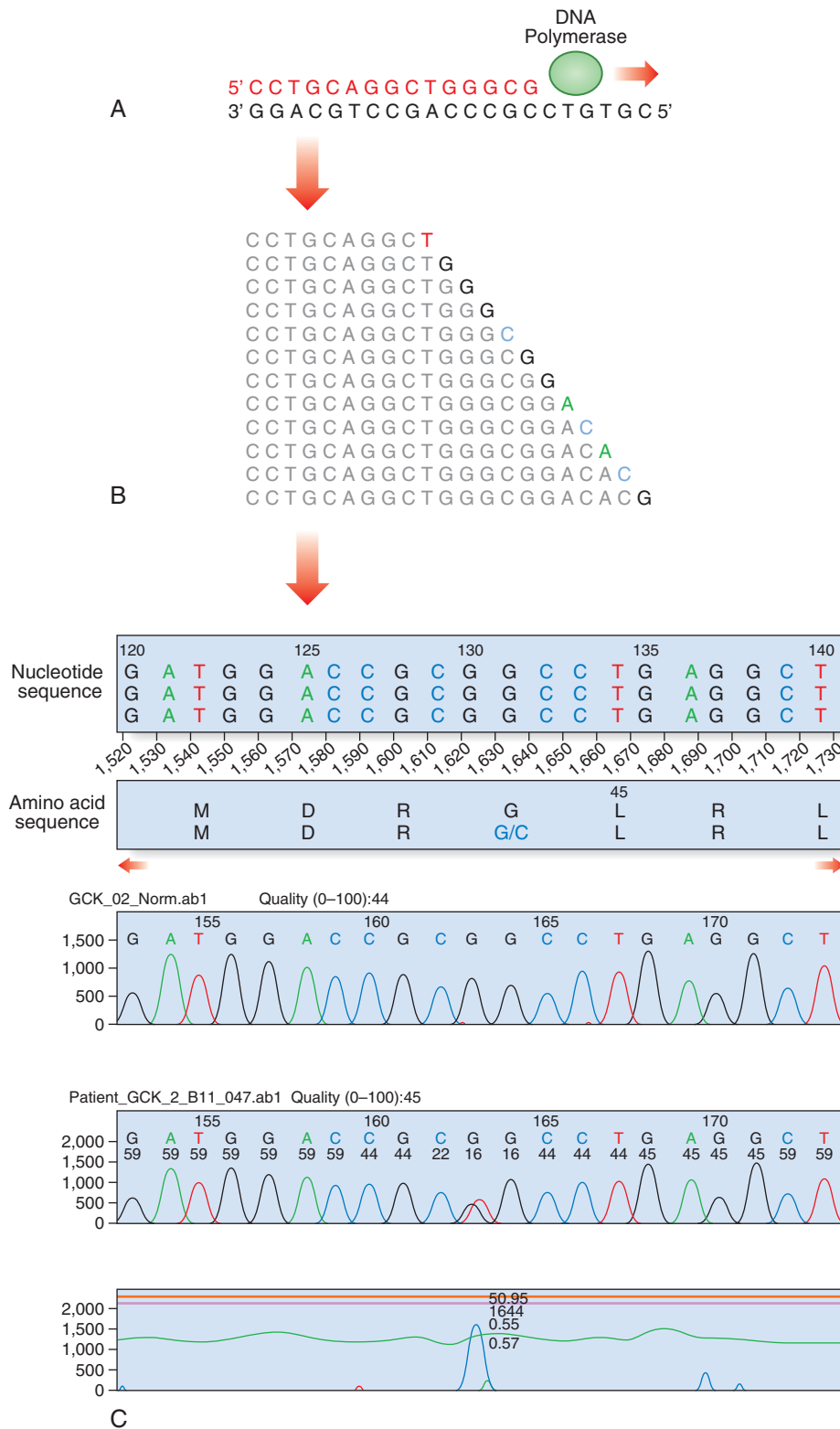
sensitive lasers. They are better able to sequence through repetitive regions where alignment of short reads is difficult.

The **sequencing by synthesis** method was developed in the mid-1990s by Cambridge scientists Shankar Balasubramanian and David Klenerman. Their ideas of using clonal arrays and massively parallel sequencing of short reads using solid-phase sequencing by reversible terminators created the basis for the technology that enables sequencing of a human genome in just a few days at a cost of approximately \$1000. By comparison, the first human genome took over a decade to sequence and was estimated to have cost \$2.7 billion!

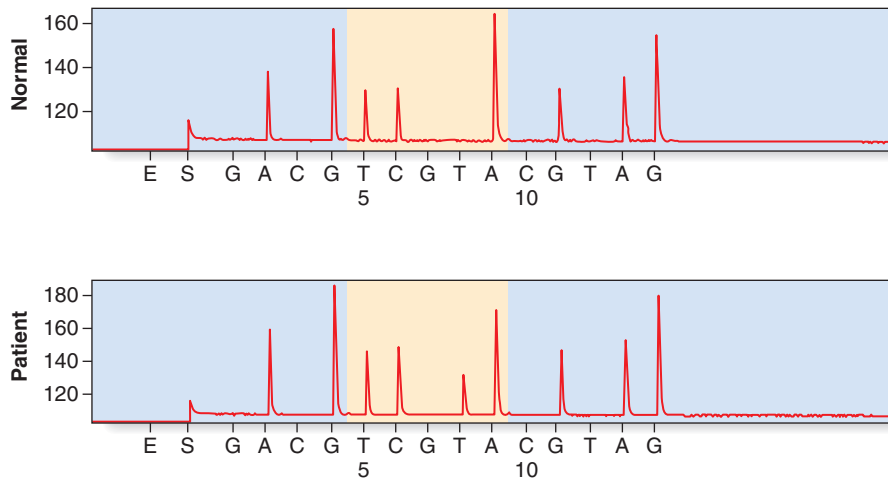
In the clinical diagnostic setting, next generation sequencing is particularly useful for the genetic diagnosis of rare diseases that exhibit genetic heterogeneity. Rather than sequencing single genes sequentially, all the genes in which mutations have been reported to cause the disease can be analyzed simultaneously in a single test. This can be achieved either through physical targeting where a defined set of genes is selected for capture by hybridization or PCR amplification, or through virtual gene panel analysis of exome (p. 47) or genome sequence data. These gene panel tests range from two genes (*BRCA1* and *BRCA2* for familial breast and ovarian cancer), to approximately 100 (for example, congenital cataract) to >1400 genes (DDDGG2P panel for developmental disorders). Exome sequencing is increasingly being used as a clinical diagnostic test where variants are filtered on the basis of a genetic strategy rather than by a gene list, for example trio sequencing (p. 47) to identify *de novo* mutations in an affected proband born to unaffected, unrelated parents.

**Table 5.4** Sanger Sequencing Compared to Next-Generation 'Clonal' Sequencing

Sanger Sequencing	Next-Generation 'Clonal' Sequencing
One sequence read per sample	Massively parallel sequencing
500–1000 bases per read	100–400 bases per read
Approx. 1 million bases per day per machine	Approx. 2 billion bases per day per machine
Approx. \$1 per 1000 bases	Approx. \$1 per 5,000,000 bases



**FIGURE 5.13** Fluorescent dideoxy DNA sequencing. The sequencing primer (*shown in red*) binds to the template and primes synthesis of a complementary DNA strand in the direction indicated (**A**). The sequencing reaction includes four dNTPs and four ddNTPs, each labeled with a different fluorescent dye. Competition between the dNTPs and ddNTPs results in the production of a collection of fragments (**B**), which are then separated by electrophoresis to generate an electropherogram (**C**). A heterozygous mutation, p.Gly44Cys (GGC > TGC; glycine > cysteine), is identified by the software.

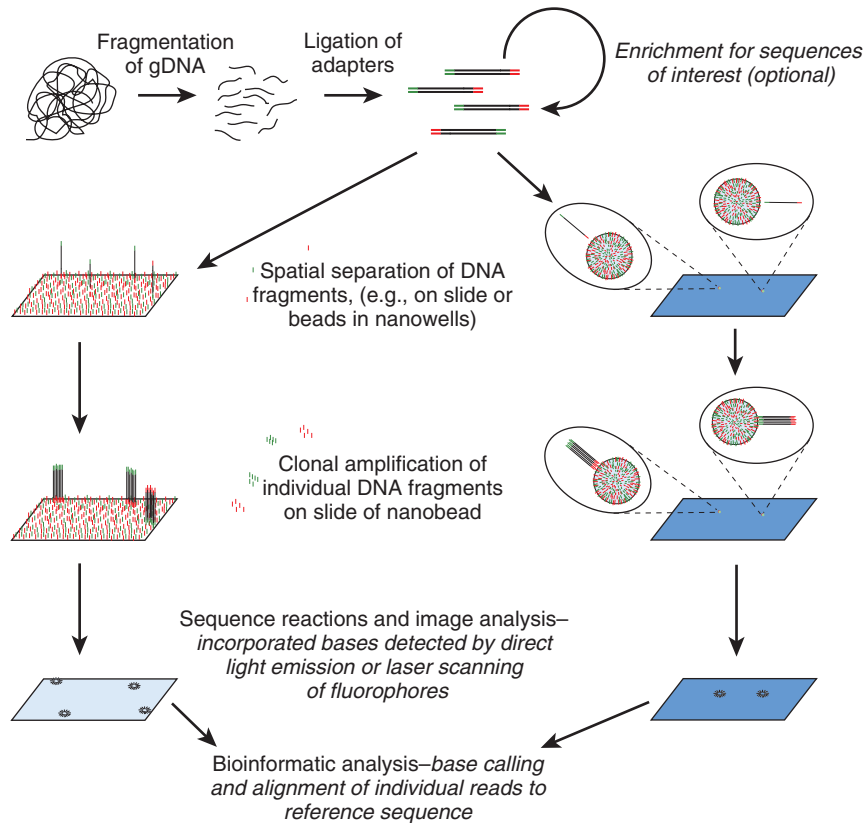


**FIGURE 5.14** Detection of a *KRAS* mutation in a colorectal tumor by pyrosequencing. The upper panel shows a normal control, sequence A GGT CAA GAG G. In the lower panel is the tumor sample with the *KRAS* mutation p.Gln61Leu (c.182A > T). (Courtesy Dr. L. Meredith, formerly at the Institute of Medical Genetics, University Hospital of Wales, Cardiff.)

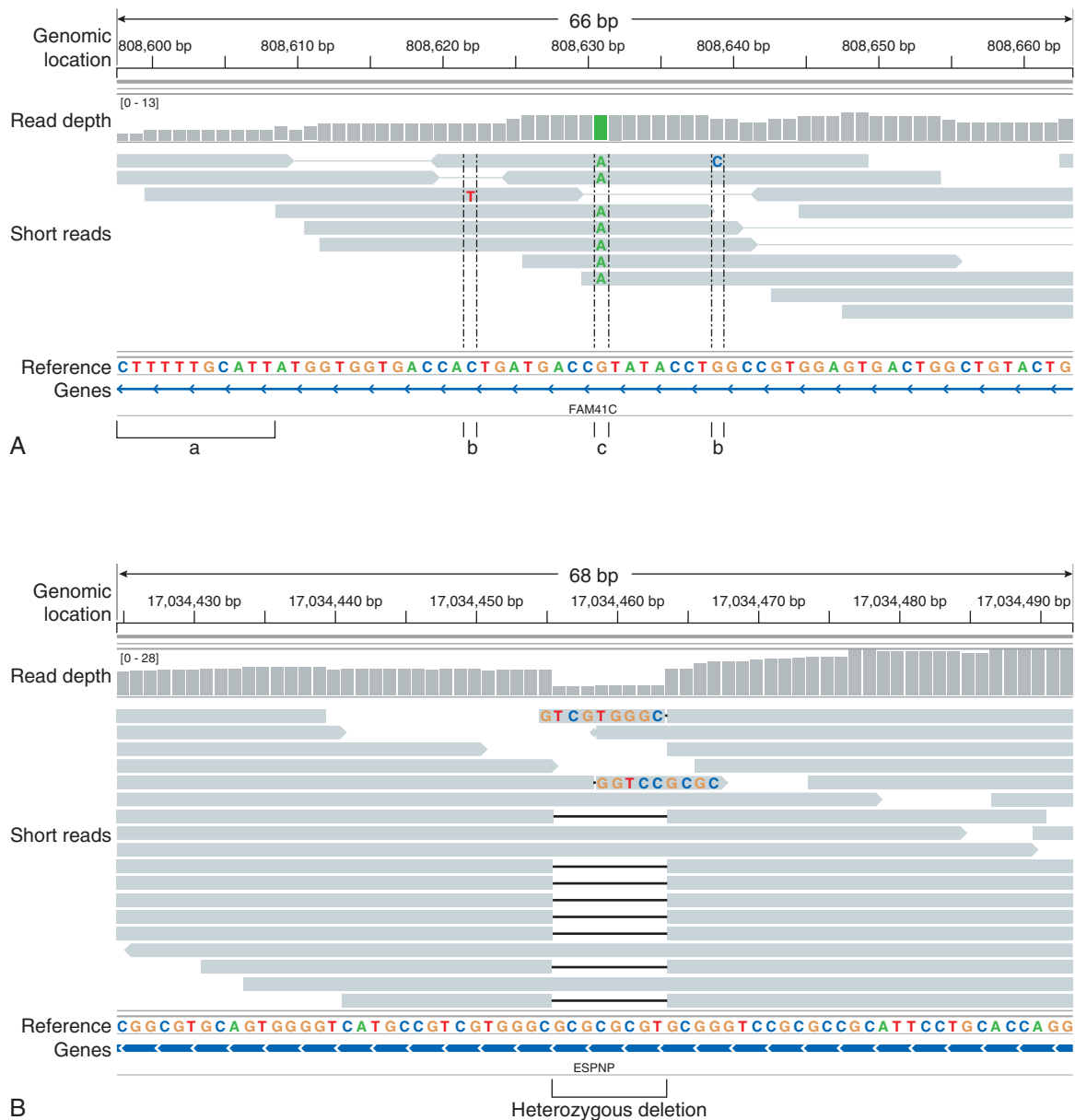
### Dosage Analysis

Most of the methods described previously will detect point mutations, small insertions, and deletions. Deletions of one or more exons are common in boys with Duchenne muscular dystrophy and may be identified by a multiplex PCR that reveals the absence of one or more PCR products. However,

these mutations are more difficult to detect in carrier females as the normal gene on the other X chromosome ‘masks’ the deletion. Large deletion and duplication mutations have been reported in a number of disorders and may encompass a single exon, several exons, or an entire gene (e.g., HNPP [p. 276]; HMSN type 1 [p. 275]). Several techniques have been developed to identify such mutations (see Table 5.5).



**FIGURE 5.15** Next-generation ‘clonal’ sequencing. DNA is fragmented and adaptors ligated before clonal amplification on a bead or glass slide. Sequencing takes place *in situ* and incorporated bases are detected by direct light emission or scanning of fluorophores. Data analysis includes base calling and alignment to a reference sequence in order to identify mutations or polymorphisms. (Courtesy Dr. R. Caswell, University of Exeter Medical School, Exeter.)



**FIGURE 5.16** **A**, Aligning individual paired-end reads to the reference genome. Nucleotides in the reads that differ from the reference sequence are marked. (a) A region with poor coverage. (b) The variants at these positions are most likely sequencing errors. (c) At this position the subject is homozygous for the A alleles. A real example would have longer reads and greater read depth. **B**, Aligned reads with a heterozygous deletion. Reads with an 8-bp deletion identified are marked with a black bar. Images produced using the IGV software package. (Courtesy Dr M. Wakeling, University of Exeter Medical School, UK.)

**Table 5.5** Methods for Detecting Copy Number Changes

Method	Known/Unknown Copy Number Change	Example	Advantages/Disadvantages
Multiplex ligation-dependent probe amplification	Known	Gene-specific or subtelomere deletion analysis	Suited to the clinical diagnostic setting, but labor-intensive and requires good quality DNA
Quantitative fluorescent PCR	Known	Prenatal aneuploidy testing	Rapid but requires informative microsatellite markers
Droplet digital PCR	Known	Confirming deletions or duplications found by a different method	Flexible; can use standard PCR primers but gene-centric approach
Array CGH	Known/unknown	Testing for severe developmental delay, learning difficulties, congenital abnormalities	Detects any deletion or duplication but interpretation of novel variants can be difficult
Next-generation sequencing	Known/unknown		Expensive equipment, enormous capacity but vast amount of data to analyze and interpretation of novel variants can be difficult

### Multiplex Ligation-Dependent Probe Amplification (MLPA)

This is a high-resolution method used to detect deletions and duplications (Figure 5.17). Each MLPA probe consists of two fluorescently labeled oligonucleotides that can hybridize, adjacent to each other, to a target gene sequence. When hybridized, the two oligonucleotides are joined by a ligase and the probe is then amplified by PCR (each oligonucleotide includes a universal primer sequence at its terminus). The probes include a variable-length stuffer sequence that enables separation of the PCR products by capillary electrophoresis. Up to 40 probes can be amplified in a single reaction.

### Quantitative Fluorescent PCR (QF-PCR)

Dosage analysis by quantitative fluorescent PCR (QF-PCR) is routinely used for rapid aneuploidy screening; for example, in prenatal diagnosis (p. 303). Microsatellites (see the following section) located on chromosomes 13, 18, and 21 may be amplified within a multiplex and trisomies detected, either by the presence of three alleles or by a dosage effect where one allele is overrepresented (Figure 5.18).

### Microarray Comparative Genomic Hybridization (CGH)

Array CGH provides a way to detect deletions and duplications on a genome-wide scale (Figure 5.19). Arrays used in clinical diagnostic laboratories include both genome wide probes to

detect novel mutations and probes targeted to known deletion/duplication syndromes. A comprehensive knowledge of normal copy number variation is essential for interpreting novel mutations.

### Next-Generation Sequencing

It is also possible to obtain copy number data from next generation sequencing if the target DNA is enriched by hybridization capture rather than PCR amplification. This is the first methodology where it is possible to detect base substitutions, small insertions and deletions, as well as copy number changes at the level of an exon or entire gene.

### Droplet Digital PCR

This technique is most useful for confirming deletion or duplication mutations identified by other methods. It involves PCR performed within thousands of nanoliter-sized droplets to achieve highly precise, absolute nucleic acid quantification. A genomic DNA sample is diluted to incorporate either one molecule or zero DNA in each droplet and mixed separately with PCR primers for the gene of interest and a reference housekeeping gene. After PCR amplification the fluorescence is measured in each droplet and the concentration of target DNA is calculated as copies per microliter from the fraction of positive reactions using Poisson statistics. The ratio of target DNA copies compared to the reference gene provides an estimate of copy number for the gene with suspected abnormal dosage.

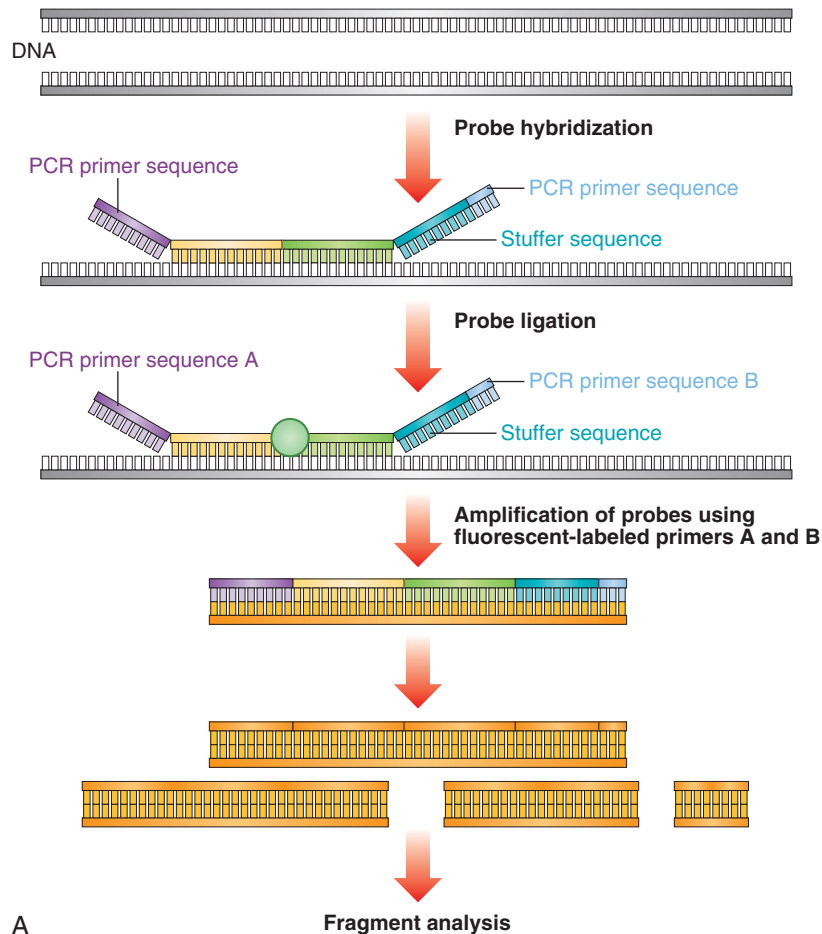
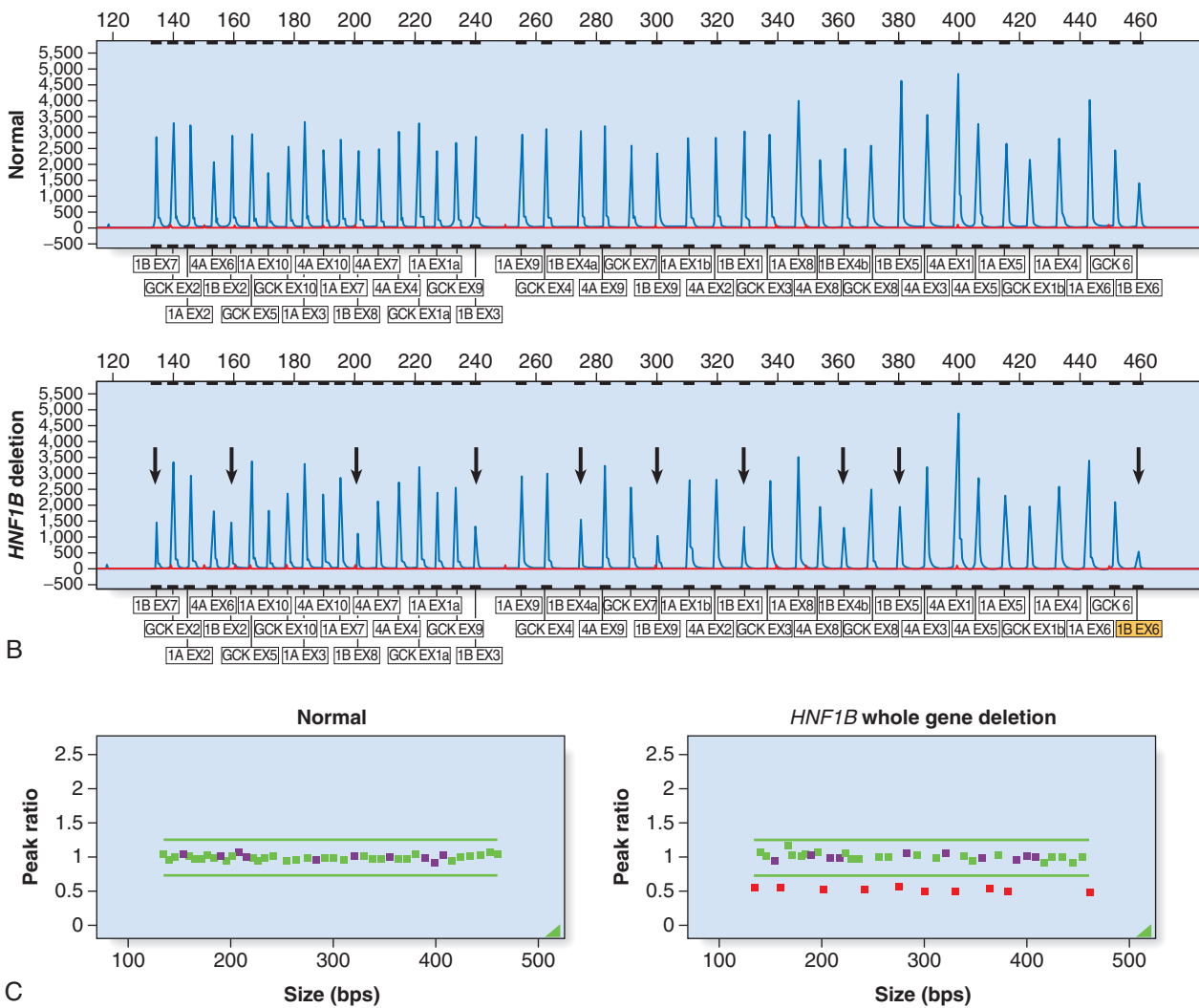
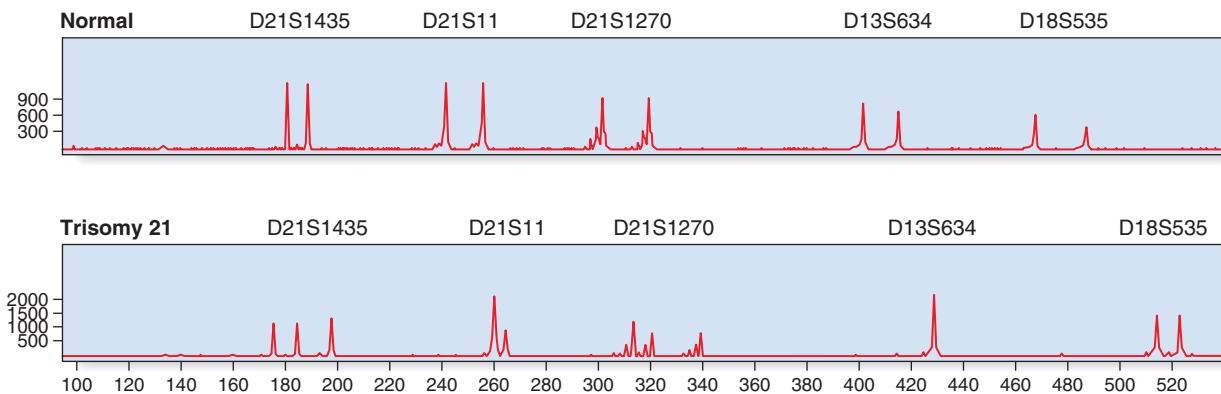


FIGURE 5.17 **A**, Illustration of multiplex ligation-dependent probe amplification (MLPA) method.

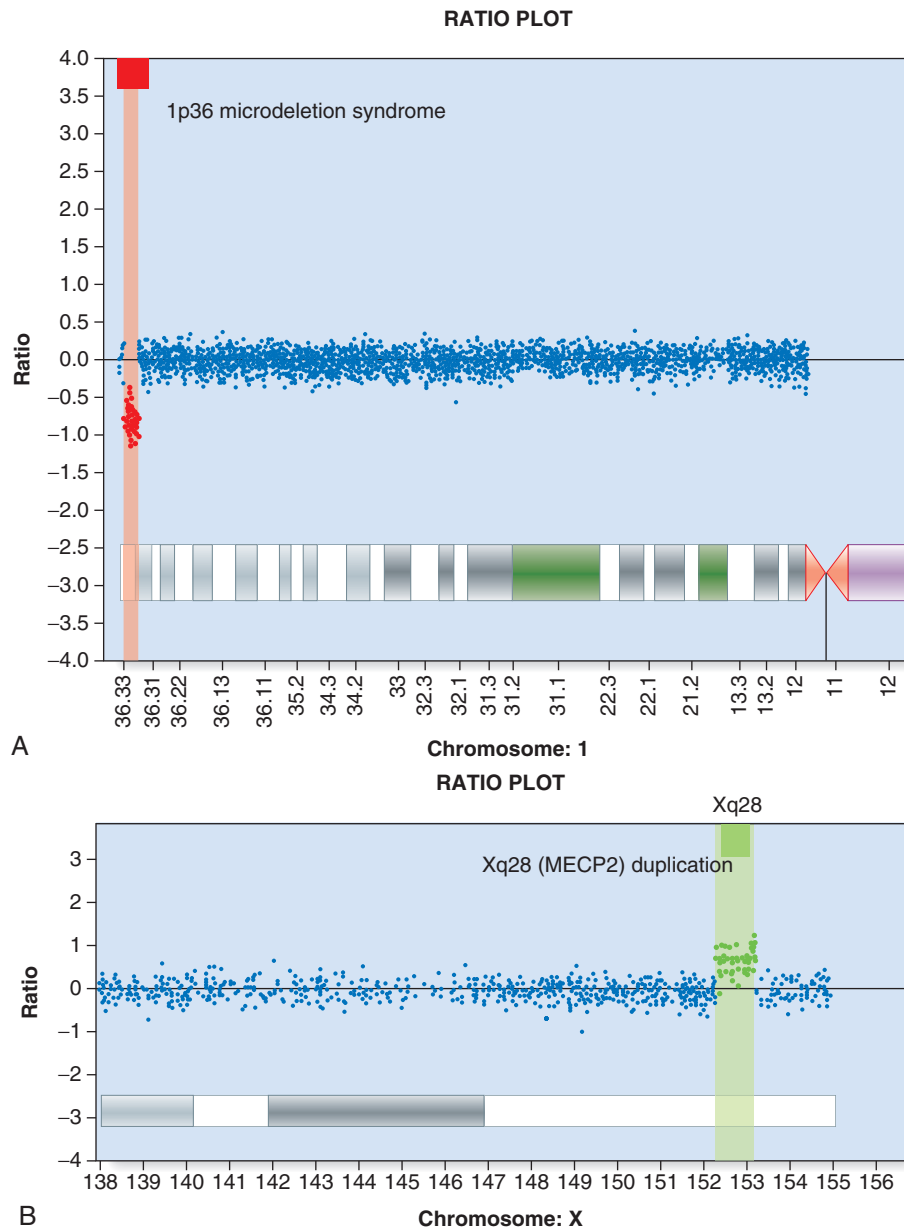




**FIGURE 5.17, cont'd B**, Detection of a whole gene deletion encompassing exons 1–9 of the *HNF1B* gene (lower panel) compared with a normal reference sample (upper panel). This MLPA kit also includes probes for the *GCK*, *HNF1A*, and *HNF4A* genes. **C**, Peak ratio plots showing in graphical form the ratio of normalized peak intensities between the normal reference and patient sample. Each point represents one peak: green or purple = peak within the normal range (0.75–1.25), red = peak either deleted (ratio <0.75) or duplicated (>1.25). The data were analyzed using GeneMarker, SoftGenetics LLC. (Courtesy M. Owens, Department of Molecular Genetics, Royal Devon and Exeter Hospital, Exeter, UK.)



**FIGURE 5.18** Quantitative fluorescent (QF)-polymerase chain reaction (PCR) for rapid prenatal aneuploidy testing. The upper panel shows a normal control, with two alleles for each microsatellite marker. The lower panel illustrates trisomy 21 with either three alleles (microsatellites D21S1435, D21S1270) or a dosage effect (D21S11). Microsatellite markers for chromosomes 13 and 18 show a normal profile. (Courtesy of C. Anderson, Institute of Medical Genetics, University Hospital of Wales, Cardiff, UK.)



**FIGURE 5.19** Identification of copy number changes by array comparative genomic hybridization (CGH) (this array includes 135,000 oligonucleotide probes). **A**, A patient with the 1p36 microdeletion syndrome. **B**, An *MECP2* duplication of chromosome Xq28. (Courtesy of R. Palmer, North East Thames Regional Genetics Service Laboratories, Great Ormond Street Hospital for Children, London.)

## Towards Genome Sequencing as a Clinical Diagnostic Test

It is now possible to sequence a human genome in just a few days at a cost of less than \$1000. Compared to exome sequencing, in the clinical setting genome sequencing offers a higher diagnostic yield through the detection of deep intronic mutations that cause aberrant splicing, mutations in regulatory elements and balanced chromosome rearrangements (Table 5.6). Although the mean read depth is generally lower than that obtained by exome sequencing, coverage is more even and this is expected to increase the sensitivity for detecting copy number changes. The major challenge is data storage and processing of the vast volume of genome sequence data. Whilst much of the non-coding sequence is currently not interpretable in the context of human disease, scientific understanding of the 'regulome' is gathering pace as initiatives such as the ENCODE

**Table 5.6** The Advantages and Disadvantages of Genome Compared to Exome Sequencing

Advantages	Disadvantages
Faster library preparation	Greater cost of sequencing
Includes introns	Greater cost of data storage
Includes regulatory elements	Many more variants to analyze
Better detection of CNVs	Difficulty in interpreting non-coding variants
Detection of structural variants	

(Encyclopedia of DNA Elements) project identify novel regulatory elements. In the future it may be possible to analyze the entire genome of a person and detect all known disease-associated variants in addition to variants that determine drug response. The unanswered question is to what degree it will be

possible to implement predictive medicine strategies based on this knowledge. Will genome sequencing become so routine that all babies have their genomes sequenced at birth? There are many ethical and social issues to debate around autonomy, genetic discrimination, data sharing and privacy.

### FURTHER READING

Deciphering Developmental Disorders Study, 2015. Large-scale discovery of novel genetic causes of developmental disorders. *Nature* 519, 223–228.

*An elegant demonstration of the power of genome-wide analysis to find novel causes of developmental disorders.*

de Ligt, J., Willemsen, M.H., van Bon, B.W., et al., 2012. Diagnostic exome sequencing in persons with severe intellectual disability. *N. Engl. J. Med.* 367, 1921–1929.

*A landmark paper describing de novo mutations causing intellectual disability identified by trio exome sequencing.*

Elles, R., Wallace, A., 2010. *Molecular diagnosis of genetic disease*, third ed. Humana Press, Clifton, NJ.

*Key techniques used for genetic testing of common disorders in diagnostic laboratories.*

Strachan, T., Read, A.P., 2011. *Human molecular genetics*, fourth ed. Garland Science, London.

*A comprehensive textbook of all aspects of molecular and cellular biology as related to inherited disease in humans.*

### ELEMENTS

- 1 Polymerase chain reaction (PCR) has revolutionized medical genetics. Within hours, more than a million copies of a gene can be amplified from a patient's DNA sample. The PCR product may be analyzed for the presence of a pathogenic mutation, gene rearrangement, or infectious agent.
- 2 Techniques including Southern and Northern blotting, DNA sequencing, and mutation screening, real-time PCR, and microarray analysis can be used to identify or analyze specific DNA sequences of interest. These techniques can be used for analyzing normal gene structure and function as well as revealing the molecular pathology of inherited disease. This provides a means for presymptomatic diagnosis, carrier detection and prenatal diagnosis.
- 3 Single nucleotide polymorphism microarrays ('chips'), array comparative genomic hybridization, and next-generation sequencing techniques allow genome wide analysis of single nucleotide polymorphisms, copy number variants, and sequence variants. These methods have changed the scale of genetic analysis and provided novel insights into genetic disease.
- 4 Next-generation sequencing allows simultaneous testing for all genes in which mutations are known to cause a monogenic disorder. The gene panel may be targeted physically by hybridization capture or PCR of selected genes, or it may be a virtual panel where the entire exome is sequenced but only specific genes are analyzed. The ability to sequence a genome for \$1000 sets the stage for genome sequencing to become a clinical diagnostic test to detect base substitutions, small insertions or deletions, copy number changes, and chromosomal rearrangements in a single test.

## Chapter 6

# Patterns of Inheritance

*That the fundamental aspects of heredity should have turned out to be so extraordinarily simple supports us in the hope that nature may, after all, be entirely approachable.*

THOMAS MORGAN (1919)

### Family Studies

To investigate whether a particular trait or disorder in humans is genetic and hereditary, we have traditionally relied either on observation of the way in which it is transmitted within a family, or on study of its frequency among relatives. This enables advice to be given to family members regarding the likelihood of their developing it or passing it on to their children (i.e., **genetic counseling**; see [Chapter 21](#)). In all clinical medicine good history taking is vital, and a good family history can sometimes provide a diagnosis. For example, a child may attend a doctor with a fracture after a minor injury. A family history of relatives with a similar tendency to fracture and blue sclerae would suggest the diagnosis of osteogenesis imperfecta, but the absence of a positive family history would prompt consideration of other diagnoses.

### Pedigree Drawing and Terminology

A family tree, or pedigree, is a shorthand system of recording pertinent family information. It usually begins with the person through whom the family came to medical attention: the **index case**, **proband**, or **propositus**; or, if female, the **proposita**. The position of the proband in the pedigree is indicated by an arrow. Information about the health of the rest of the family is obtained by asking direct questions about brothers, sisters, parents, and maternal and paternal relatives, with the relevant information about the sex of the individual, affection status, and relationship to other individuals being carefully recorded on the chart ([Figure 6.1](#)). Attention to detail can be crucial because patients do not always appreciate the importance of miscarriages, or the difference between siblings and *half*-siblings, for example.

### Mendelian Inheritance

More than 16,000 traits or disorders in humans exhibit single gene **unifactorial** or **mendelian inheritance**. However, characteristics such as height, and many common familial disorders, such as diabetes or hypertension, do not usually follow a simple pattern of mendelian inheritance (see [Chapter 10](#)).

A trait or disorder that is determined by a gene on an autosome is said to show **autosomal inheritance**, whereas a trait or disorder determined by a gene on one of the sex chromosomes is said to show **sex-linked inheritance**.

### Autosomal Dominant Inheritance

An autosomal dominant trait is one that manifests in the heterozygous state, that is, in a person possessing both an abnormal or mutant allele and the normal allele. It is often possible to trace a dominantly inherited trait or disorder through many generations of a family ([Figure 6.2](#)). In South Africa, the vast majority of cases of porphyria variegata can be traced back to one couple in the late seventeenth century. This is a metabolic disorder characterized by skin blistering as a result of increased sensitivity to sunlight ([Figure 6.3](#)), and urine that becomes ‘port wine’ colored on standing as a result of the presence of porphyrins (p. 266). This pattern of inheritance is sometimes referred to as ‘vertical’ transmission and is confirmed when male–male (i.e., father to son) transmission is observed.

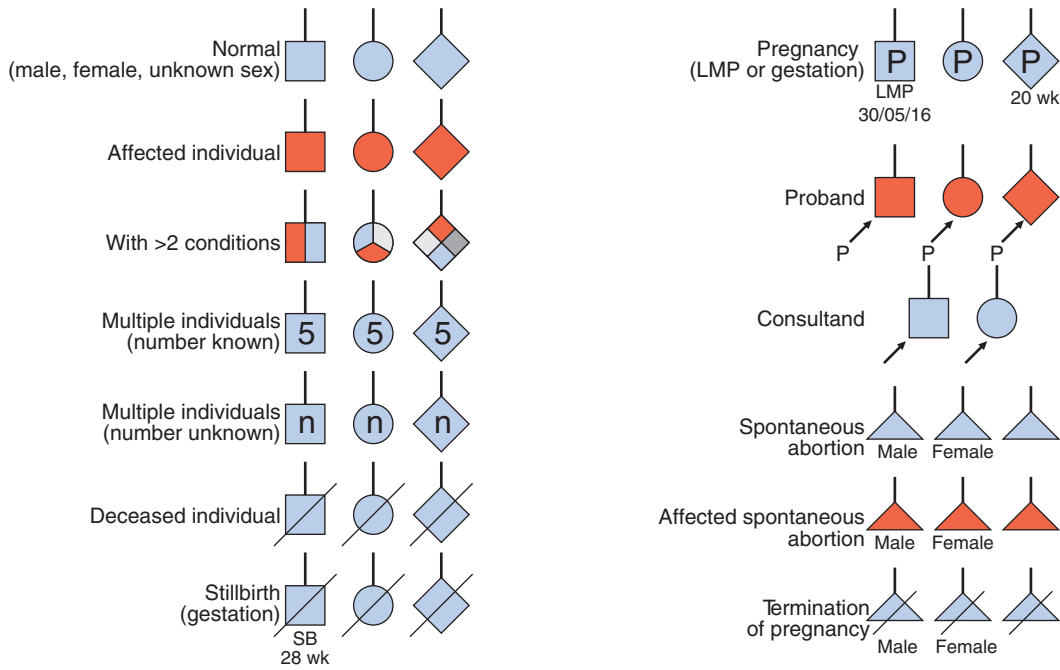
### Genetic Risks

Each gamete from an individual with a dominant trait or disorder will contain either the normal allele or the mutant allele. If we represent the dominant mutant allele as ‘D’ and the normal allele as ‘d’, then the possible combinations of the gametes is seen in [Figure 6.4](#). Any child born to a person affected with a dominant trait or disorder has a 1 in 2 (50%) chance of inheriting it and being similarly affected. These diagrams are often used in the genetic clinic to explain segregation to patients and are more user-friendly than a Punnett square (see [Figures 1.3](#) and [7.1](#)).

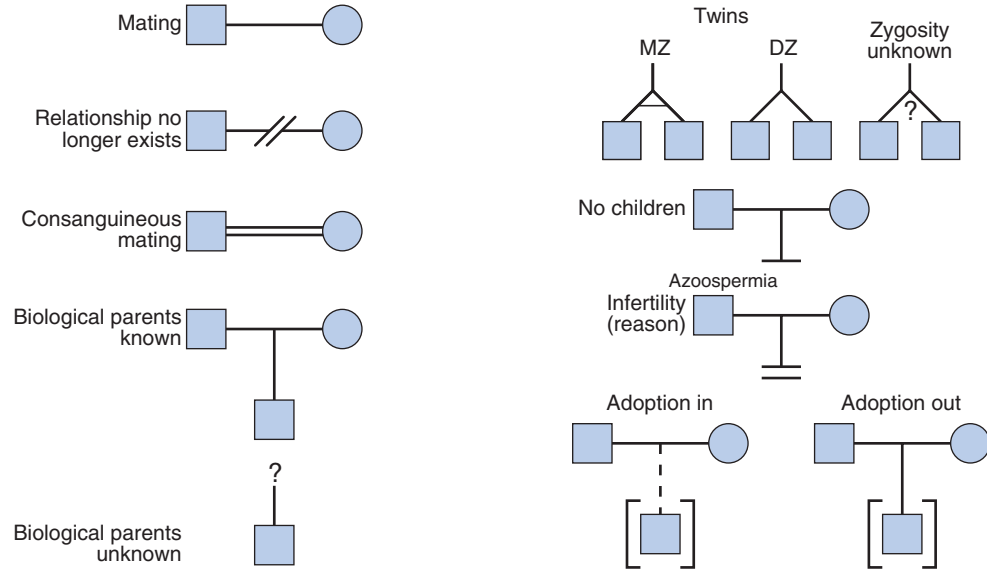
### Pleiotropy

Autosomal dominant traits may involve only one organ or part of the body, for example the eye in congenital cataracts. It is common, however, for autosomal dominant disorders to manifest in different systems of the body in a variety of ways. This is **pleiotropy**—a single gene that may give rise to two or more apparently unrelated effects. In tuberous sclerosis, affected individuals can present with a range of problems including learning difficulties, epilepsy, a facial rash known as adenoma sebaceum (histologically composed of blood vessels and fibrous tissue known as angiokeratoma) or subungual fibromas ([Figure 6.5](#)); some affected individuals have all features, whereas others may have almost none. Some discoveries are challenging our conceptual understanding of the term **pleiotropy** on account of the remarkably diverse syndromes that can result from different mutations in the same gene—for example, the *LMNA* gene (which encodes lamin A/C) and the X-linked filamin A (*FLNA*) gene. Mutations in *LMNA* may cause Emery-Dreifuss muscular dystrophy, a form of limb girdle muscular dystrophy, a form of Charcot-Marie-Tooth disease (p. 275), dilated cardiomyopathy (p. 290) with conduction abnormality, Dunnigan-type familial partial lipodystrophy ([Figure 6.6](#)), mandibuloacral dysplasia, and a very rare condition that has always been a great curiosity—Hutchinson-Gilford progeria. These are due to heterozygous mutations, with the

**Individuals**



**Relationships**



**Assisted reproductive scenarios**

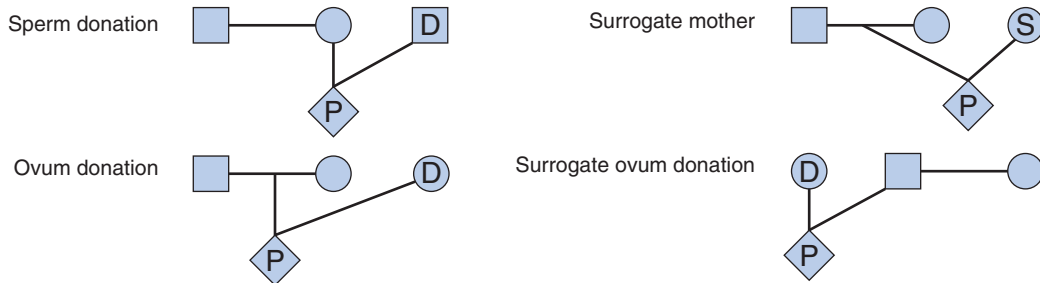


FIGURE 6.1 Symbols used to represent individuals and relationships in family trees.

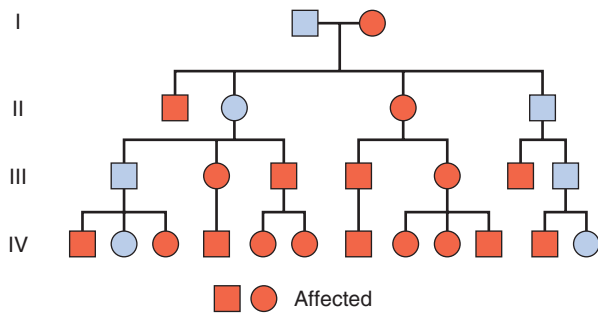


FIGURE 6.2 Family tree of an autosomal dominant trait. Note the presence of male-to-male transmission.



FIGURE 6.3 Blistering skin lesions on the hand in porphyria variegata.

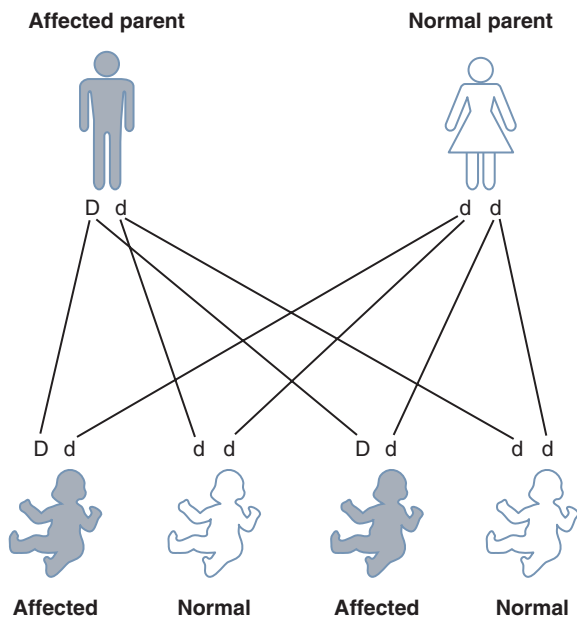


FIGURE 6.4 Segregation of alleles in autosomal dominant inheritance. *D* represents the mutated allele, whereas *d* represents the normal allele.



FIGURE 6.5 The facial rash (A) of angiokeratoma (adenoma sebaceum) in a male with tuberous sclerosis, and a typical subungual fibroma of the nail bed (B).

exception of Charcot-Marie-Tooth disease and mandibuloacral dysplasia, which are recessive—affected individuals are therefore homozygous for *LMNA* mutations. Sometimes an individual with a mutation is entirely normal. Mutations in the filamin A gene have been implicated in the distinct, though overlapping, X-linked dominant dysmorphic conditions oto-palato-digital syndrome, Melnick-Needles syndrome and frontometaphyseal dysplasia. However, it could not have been foreseen that a form of X-linked dominant epilepsy in women, called periventricular nodular heterotopia, is also due to mutations in this gene.

### Variable Expressivity

The clinical features in autosomal dominant disorders can show striking variation from person to person, even in the same family. This difference between individuals is referred to as **variable expressivity**. In autosomal dominant polycystic kidney disease, for example, some affected individuals develop renal



**FIGURE 6.6** Dunnigan-type familial partial lipodystrophy due to a mutation in the lamin A/C gene. The patient lacks adipose tissue, especially in the distal limbs. A wide variety of clinical phenotypes is associated with mutations in this one gene.

failure in early adulthood whereas others have just a few renal cysts that do not affect renal function significantly.

### Reduced Penetrance

In some individuals heterozygous for gene mutations giving rise to certain autosomal dominant disorders, there may be very few abnormal clinical features and they demonstrate **reduced penetrance**. This may be the result of the modifying effects of other genes, as well as interaction of the gene with environmental factors. An individual with no features of a disorder despite being heterozygous for a particular gene mutation is said to demonstrate **non-penetrance**; in lay terms the condition ‘skips a generation’ (see also p. 95).

Reduced penetrance and variable expressivity, together with the pleiotropic effects of a mutant allele, all need to be taken into account when trying to interpret family history information for autosomal dominant disorders. A good example is Treacher-Collins syndrome. In its most obvious manifestation the facial features are unmistakable (Figure 6.7). However, the mother of the child illustrated is also known to harbor the gene (*TCOF1*) mutation as she has close relatives with the condition.

### New Mutations

In autosomal dominant disorders an affected person usually has an affected parent. However, this is not always the case and it is not unusual for a trait to appear in an individual when there is no family history of the disorder. A striking example is achondroplasia, a form of short-limbed dwarfism (pp. 114–115), in which the parents usually have normal stature. The sudden unexpected appearance of a genetic condition arising as a result of a pathogenic heterozygous gene variant is called a **new mutation**. Dominant inheritance in achondroplasia was confirmed by the observation that the offspring of an affected individual had a 50% chance of also being affected. In less dramatic conditions other explanations for the ‘sudden’ appearance of a disorder must be considered. This includes non-penetrance and

variable expression, as previously mentioned. However, the astute clinician also needs to be aware that the family relationships may not be as stated—i.e., there may be undisclosed **non-paternity** (or, occasionally, **non-maternity**).

New dominant mutations, in certain instances, have been associated with an increased age of the father. Traditionally, this is believed to be a consequence of the large number of mitotic divisions that male gamete stem cells undergo during a man’s reproductive lifetime (p. 32). However, this may well be a simplistic view. In relation to mutations in *FGFR2* (craniosynostosis syndromes), Wilkie’s group in Oxford demonstrated that causative gain-of-function mutations confer a selective advantage to spermatogonial stem cells, so that mutated cell lines accumulate in the testis.

### Co-Dominance

**Co-dominance** is the term used for two allelic traits that are both expressed in the heterozygous state. In persons with blood group AB it is possible to demonstrate both A and B blood group substances on the red blood cells, so the A and B blood groups are therefore co-dominant (p. 174).

### Homozygosity for Autosomal Dominant Traits

The rarity of most autosomal dominant disorders and diseases means that they usually occur only in the heterozygous state. Occasionally, however, children are born to couples where both parents are heterozygous for a dominantly inherited disorder.



**FIGURE 6.7** The baby in this picture has Treacher-Collins syndrome, resulting from a mutation in *TCOF1*. The mandible is small, the palpebral fissures slant downward, there is usually a defect (coloboma) of the lower eyelid, the ears may show microtia, and hearing impairment is common. The condition follows autosomal dominant inheritance but is very variable—the baby’s mother also has the mutation but she shows no obvious signs of the condition.

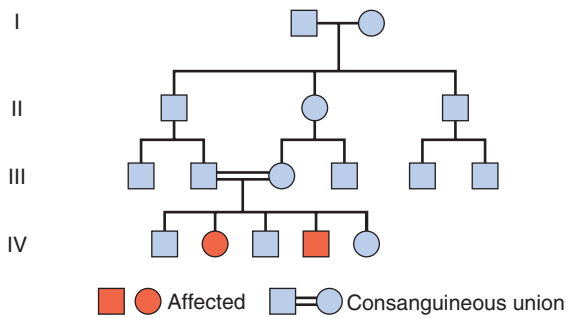


FIGURE 6.8 Family tree of an autosomal recessive trait.

Such offspring are at risk of being homozygous for the gene mutations. In some instances, affected individuals appear either to be more severely affected, as has been reported with achondroplasia, or to have an earlier age of onset, as in familial hypercholesterolemia (p. 262). Conversely, with other dominantly inherited disorders, homozygous individuals are not more severely affected than heterozygotes—e.g., Huntington disease (p. 273) and myotonic dystrophy (p. 285). These different phenotypic effects may be explained by the nature of the mutation—whether they are gain-of-function (p. 20) or loss-of-function (p. 20).

### Autosomal Recessive Inheritance

Recessive traits and disorders are manifest only when the mutant allele is present in a double dose (i.e., homozygosity). Individuals heterozygous for such mutant alleles show no features of the disorder and are perfectly healthy; they are **carriers**. The family tree for recessive traits (Figure 6.8) differs markedly from that seen in autosomal dominant traits. It is not possible to trace an autosomal recessive trait or disorder through the family, as all the affected individuals in a family are usually in a single **sibship** (i.e., brothers and sisters). This was sometimes referred to as ‘horizontal’ transmission, but this is an inappropriate and misleading term.

### Consanguinity

Enquiry into the family history of individuals affected with rare recessive traits or disorders might reveal that their parents are related (i.e., **consanguineous**). The rarer a recessive trait or disorder, the greater the frequency of consanguinity among the parents of affected individuals. In cystic fibrosis, the most common ‘serious’ autosomal recessive disorder in western Europeans (p. 286), the frequency of parental consanguinity is only slightly greater than that seen in the general population. By contrast, when Bateson and Garrod originally described the very rare alkaptonuria, they observed that one-quarter or more of the parents were first cousins, and rightly reasoned that rare alleles are more likely to ‘meet up’ in the offspring of cousins than unrelated parents. In large inbred kindreds, an autosomal recessive condition may be present in more than one branch of the family.

### Genetic Risks

If we represent the normal dominant allele as ‘R’ and the recessive mutant allele as ‘r’, then each parental gamete carries either the mutant or the normal allele (Figure 6.9). The various possible combinations of gametes mean that the offspring of two heterozygotes have a 1 in 4 (25%) chance of being homozygous affected, a 1 in 2 (50%) chance of being heterozygous

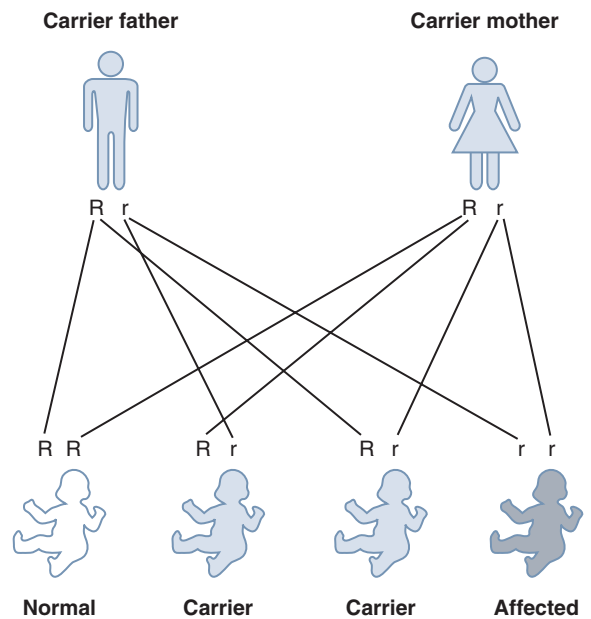


FIGURE 6.9 Segregation of alleles in autosomal recessive inheritance. *R* represents the normal allele, *r* the mutated allele.

unaffected, and a 1 in 4 (25%) chance of being homozygous unaffected.

### Pseudodominance

If an individual who is homozygous for an autosomal recessive disorder has children with a carrier of the same disorder, their offspring have a 1 in 2 (50%) chance of being affected. Such a pedigree is said to exhibit **pseudodominance** (Figure 6.10).

### Locus Heterogeneity

Some clinical conditions can be due to mutations in more than one gene, thus demonstrating **locus heterogeneity**. For example, sensorineural hearing loss/deafness most commonly follows autosomal recessive inheritance. Deaf persons, by virtue of their schooling and involvement in the deaf community, often choose to have children with another deaf person. If two deaf persons are homozygous for the same recessive gene, all of their children will be similarly affected. However, there are families in which all the children born to parents who both have autosomal recessive deafness have had perfectly normal hearing

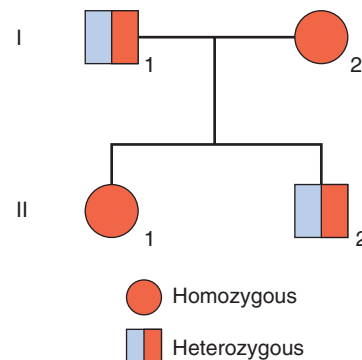


FIGURE 6.10 A pedigree with a woman ( $I_2$ ) homozygous for an autosomal recessive disorder whose husband ( $I_1$ ) is heterozygous for the same disorder. They have a homozygous affected daughter so that the pedigree shows pseudodominant inheritance.



because they are **double heterozygotes**. The parents are therefore homozygous for mutant genes at different loci. In fact, there are more than 80 genes or gene loci known to be implicated in recessively inherited deafness, and a similar story applies to autosomal recessive retinitis pigmentosa.

Disorders with the same phenotype from different genetic loci are known as **genocopies**, whereas when the same phenotype results from environmental causes it is known as a **phenocopy**.

### Mutational Heterogeneity

Heterogeneity can also occur at the allelic level. In the majority of single-gene disorders (e.g.,  $\beta$ -thalassemia) a large number of different mutations have been identified as being responsible (p. 160). There are individuals who have two different mutations at the same locus and are known as **compound heterozygotes**, constituting what is known as **allelic** or **mutational heterogeneity**. Most individuals affected with an autosomal recessive disorder are probably compound heterozygotes rather than true homozygotes, unless their parents are related, in which case they are likely to be homozygous for the same mutation by descent, inherited from a common ancestor.

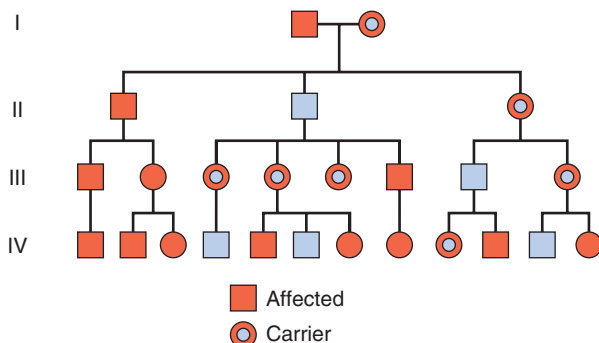
### Sex-Linked Inheritance

Sex-linked inheritance refers to the pattern of inheritance shown by genes that are located on either of the sex chromosomes. Genes carried on the X chromosome are referred to as being **X-linked**, and those carried on the Y chromosome are referred to as exhibiting **Y-linked** or **holandric inheritance**.

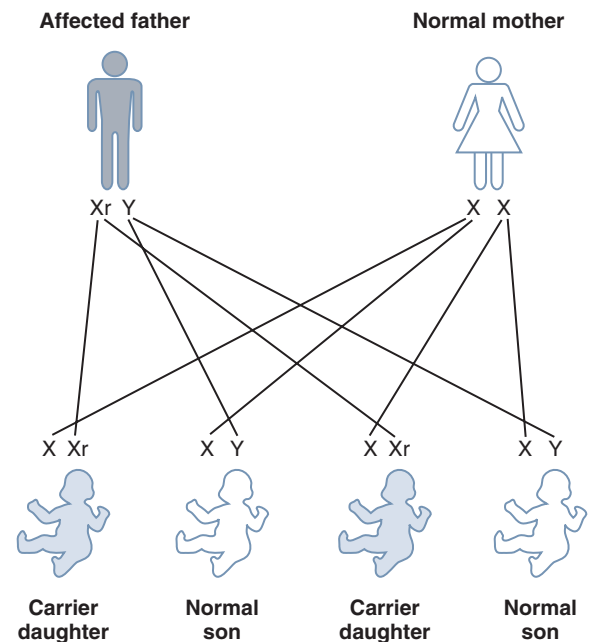
### X-Linked Recessive Inheritance

An X-linked recessive trait is one determined by a gene carried on the X chromosome and usually manifests only in males. A male with a mutant allele on his single X chromosome is said to be hemizygous for that allele. Diseases inherited in an X-linked recessive manner are transmitted by (usually) healthy heterozygous female carriers to affected males, as well as by affected males to their obligate carrier daughters, with a consequent risk to male grandchildren through these daughters (Figure 6.11). This was sometimes referred to as 'diagonal' or a 'knight's move' pattern of transmission.

The mode of inheritance whereby only males are affected by a disease that is transmitted by normal females was appreciated by the Jews nearly 2000 years ago. They excused from circumcision the sons of all the sisters of a mother who had sons with the 'bleeding disease', in other words, hemophilia (p. 300). The sons of the father's siblings were not excused.



**FIGURE 6.11** Family tree of an X-linked recessive trait in which affected males reproduce.



**FIGURE 6.12** Segregation of alleles in X-linked recessive inheritance, relating to the offspring of an affected male. *r* represents the mutated allele.

Queen Victoria was a carrier of hemophilia, and her carrier daughters, who were perfectly healthy, introduced the gene into the Russian and Spanish royal families. In the British royal family Queen Victoria's son, Edward VII, did not inherit the gene (see Figure 19.26).

### Genetic Risks

A male transmits his X chromosome to each of his daughters and his Y chromosome to each of his sons. If a male affected with hemophilia has children with a normal female, then all of his daughters will be **obligate carriers** but none of his sons will be affected (Figure 6.12). A male cannot transmit an X-linked trait to his son, with the very rare exception of uniparental heterodisomy (p. 77).

For a carrier female of an X-linked recessive disorder having children with a normal male, each son has a 1 in 2 (50%) chance of being affected and each daughter has a 1 in 2 (50%) chance of being a carrier (Figure 6.13).

Some X-linked disorders are not compatible with survival to reproductive age and are not, therefore, transmitted by affected males. Duchenne muscular dystrophy is the commonest severe muscle disease (p. 281). The first sign is delayed walking followed by a waddling gait, difficulty in climbing stairs unaided, and frequent falls. By approximately 10 years of age affected boys usually require a wheelchair. The muscle weakness is progressive and affected males become bed-bound and often die in their early 20s, though survival has improved significantly with steroids and respiratory support (Figure 6.14). Because affected boys rarely survive to reproduce, the disease is transmitted by healthy female carriers (Figure 6.15), or may arise as a new mutation.

### Variable Expression in Heterozygous Females

In humans, several X-linked disorders are known in which heterozygous females have a mosaic phenotype with a mixture of features of the normal and mutant alleles. In X-linked ocular

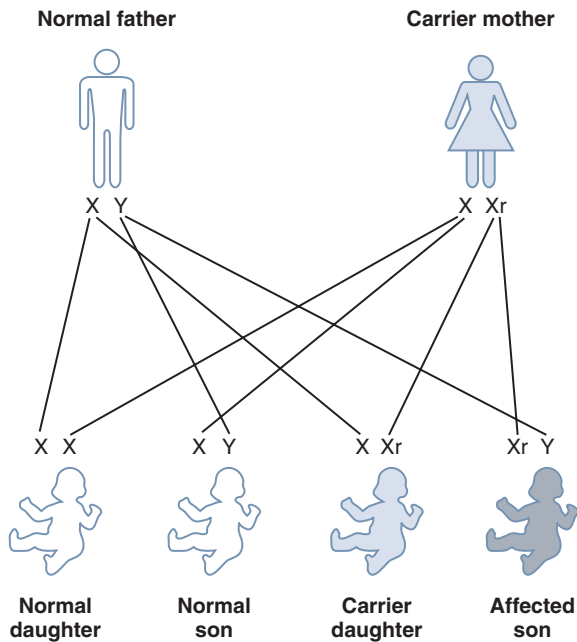


FIGURE 6.13 Segregation of alleles in X-linked recessive inheritance, relating to the offspring of a carrier female. *r* represents the mutated allele.

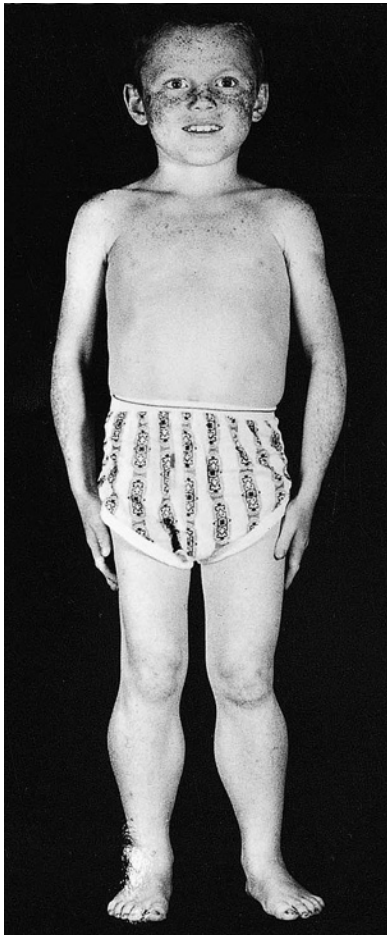


FIGURE 6.14 Boy with Duchenne muscular dystrophy; note the enlarged calves and wasting of the thigh muscles.

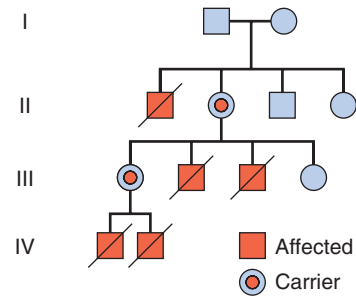


FIGURE 6.15 Family tree of Duchenne muscular dystrophy with the disorder being transmitted by carrier females and affecting males, who do not survive to transmit the disorder.

albinism, the iris and ocular fundus of affected males lack pigment. Careful examination of the ocular fundus in females heterozygous for ocular albinism reveals a mosaic pattern of pigmentation (see Figure 11.1, p. 144). This is explained by the random process of X-inactivation (p. 122); in the pigmented areas the normal gene is on the active X chromosome, and in depigmented areas the mutant allele is on the active X chromosome.

**Females Affected With X-Linked Recessive Disorders**

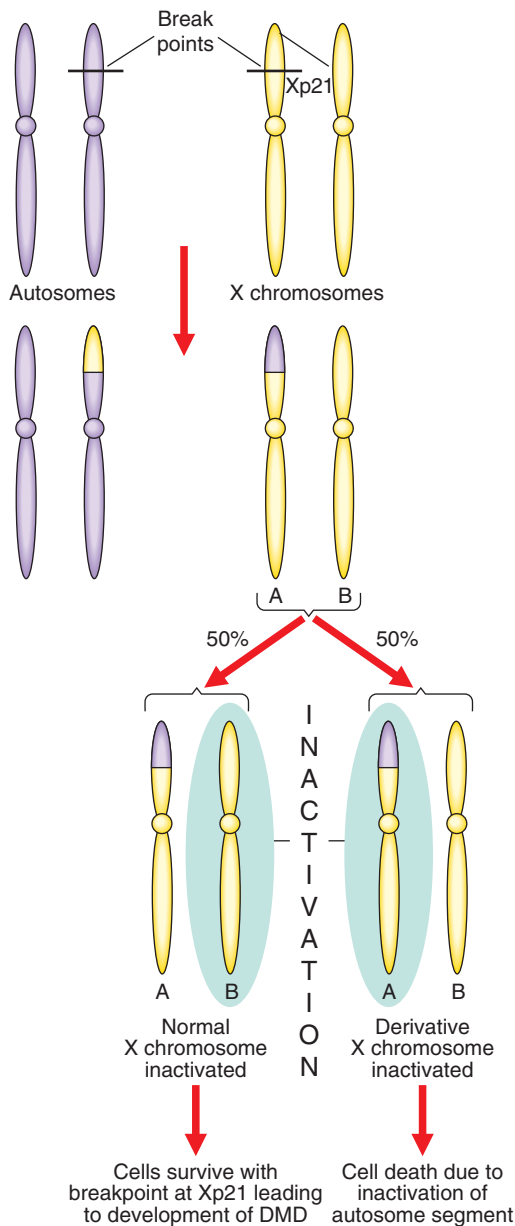
Occasionally a woman might manifest features of an X-linked recessive trait. There are several explanations for how this can happen.

**Homozygosity for X-Linked Recessive Disorders.** A common X-linked recessive trait is red-green color blindness—the inability to distinguish between the colors red and green. Approximately 8% of males are red-green color blind and, although it is unusual, because of the high frequency of this allele in the population approximately 1 in 150 women are red-green color blind by virtue of both parents having the allele on the X chromosome. Therefore, a female can be affected with an X-linked recessive disorder as a result of homozygosity for an X-linked allele, although the rarity of most X-linked conditions means that the phenomenon is uncommon. A female could also be homozygous if her father was affected and her mother was normal, but a new mutation occurred on the X chromosome transmitted to the daughter; vice versa, it could happen if her mother was a carrier and her father was normal, but a new mutation occurred on the X chromosome he transmitted to his daughter—but these scenarios are rare.

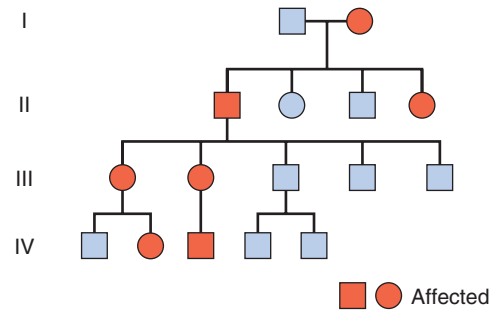
**Skewed X-Inactivation.** The process of X-inactivation (p. 122) usually occurs randomly, there being an equal chance of either of the two X chromosomes in a heterozygous female being inactivated in any one cell. After X-inactivation in embryogenesis, therefore, in roughly half the cells one of the X chromosomes is active, whereas in the other half it is the other X chromosome that is active. Sometimes this process is not random, allowing for the possibility that the active X chromosome in most of the cells of a heterozygous female carrier is the one bearing the mutant allele. If this happens, a carrier female would exhibit some of the symptoms and signs of the disease and be a so-called **manifesting heterozygote** or **carrier**. This occasionally occurs in Duchenne muscular dystrophy and hemophilia A, for example (pp. 281, 300). In addition, there are reports of X-linked disorders in which a number of manifesting carriers cluster in the same family, consistent with the coincidental inheritance of an abnormality of X-inactivation (p. 174).

**Numerical X-Chromosome Abnormalities.** A female could manifest an X-linked recessive disorder if she carries an X-linked recessive mutation and has a single X chromosome (i.e., Turner syndrome, see p. 240). Women with Turner syndrome and hemophilia A, or Duchenne muscular dystrophy, have been reported.

**X-Autosome Translocations.** Females with a translocation involving one of the X chromosomes and an autosome can be affected with an X-linked recessive disorder. If the breakpoint of the translocation disrupts a gene on the X chromosome, then a female can be affected. This is because the X chromosome involved in the translocation survives preferentially so as to maintain functional disomy of the autosomal genes (Figure 6.16). The observation of females affected with Duchenne muscular dystrophy, and having X-autosome translocations



**FIGURE 6.16** Generation of an X-autosome translocation with breakpoint in a female and how this results in the development of Duchenne muscular dystrophy.



**FIGURE 6.17** Family tree of an X-linked dominant trait.

involving the same region of the short arm of the X, helped to map the Duchenne muscular dystrophy gene (p. 283).

**X-Linked Dominant Inheritance**

Although uncommon, there are disorders that are manifest in the heterozygous female, as well as in the male who has the mutant allele on his single X chromosome. This is known as X-linked dominant inheritance (Figure 6.17). Superficially this resembles an autosomal dominant trait because both the daughters and sons of an affected female have a 1 in 2 (50%) chance of being affected. However, in X-linked dominant inheritance an affected male transmits the trait to all his daughters but to none of his sons, resulting in an excess of affected females and no direct male-to-male transmission of the disorder.

X-linked dominant traits include X-linked hypophosphatemia, also known as vitamin D-resistant rickets. Rickets can be due to a dietary deficiency of vitamin D, but in vitamin D-resistant rickets the disorder occurs even when there is an adequate dietary intake of vitamin D. In the X-linked dominant form of vitamin D-resistant rickets, both males and females are affected with short stature due to short, and often bowed, long bones, although the females usually have less severe skeletal changes than males. The X-linked form of Charcot-Marie-Tooth disease (hereditary motor and sensory neuropathy, p. 275) is another example.

A mosaic pattern of involvement can be demonstrated in females heterozygous for some X-linked dominant disorders. An example is the mosaic pattern of abnormal pigmentation of the skin that follows developmental lines seen in females heterozygous for the X-linked dominant disorder incontinentia pigmenti (Figure 6.18). This is also an example of a disorder that is usually lethal for male embryos that inherit the mutated allele. Others include the neurological conditions Rett syndrome and periventricular nodular heterotopia due to mutations in *FLNA*.

**Paradoxical X-Linked Inheritance**

Recently it has become clear that patients who are hemizygous for mutations in the X-linked gene *PCDH19* demonstrate the complete reversal of what is expected—males are unaffected and females are severely affected with a form of early infantile epileptic encephalopathy (EIEE-type 9). This is totally counter-intuitive to our understanding of X-linked inheritance and several possible explanations have been proposed. This includes the theory that the heterozygous state produces a harmful effect due to ‘metabolic interference’ between the protein product of the mutated allele and that of the normal allele, whereas the mutated allele alone is benign. Another possibility is that X-inactivation is disturbed by the mutant allele, giving



**FIGURE 6.18** Mosaic pattern of skin pigmentation in a female with the X-linked dominant disorder, incontinentia pigmenti. The patient has a mutation in a gene on one of her X chromosomes; the pigmented areas indicate tissue in which the normal X chromosome has been inactivated. This developmental pattern follows Blaschko's lines (see [Chapter 17](#), p. 239).

rise in females to 'functional disomy' for genes not inactivated. This parallels the situation in learning disabled, dysmorphic females with a ring X-chromosome, which is not activated because there is no functional X-inactivation center.

### Y-Linked Inheritance

**Y-linked** or **holandric inheritance** implies that only males are affected. An affected male transmits Y-linked traits to all of his sons but to none of his daughters. In the past it has been suggested that bizarre-sounding conditions such as porcupine skin, hairy ears and webbed toes are Y-linked traits. With the possible exception of hairy ears, these claims of holandric inheritance can be dismissed. Evidence clearly indicates, however, that the H-Y histocompatibility antigen (p. 170) and genes involved in spermatogenesis are carried on the Y chromosome and, therefore, manifest holandric inheritance. The latter, if deleted, leads to infertility from azoospermia in males. The recent advent of techniques of assisted reproduction, particularly the technique of intracytoplasmic sperm injection (ICSI), means that, if a pregnancy with a male conceptus results after the use of this technique, the child will also necessarily be infertile.

### Partial Sex-Linkage

**Partial sex-linkage** has been used in the past to account for certain disorders that appear to exhibit autosomal dominant inheritance in some families and X-linked inheritance in others. In fact, this is because of genes present on the tip of Xp which share homology with the Y chromosome (which escapes X-inactivation). During meiosis, pairing occurs between the

homologous Xp and Yp chromosomal regions, the so-called **pseudoautosomal region** (p. 122; [Figure 9.28](#)). As a result of a meiotic cross-over, a gene could be transferred from the X to the Y chromosome, or vice versa, allowing the possibility of male-to-male transmission. The latter instances would be consistent with autosomal dominant inheritance. A rare skeletal dysplasia, Leri-Weil dyschondrosteosis, in which affected individuals have short stature and a characteristic wrist deformity (Madelung deformity), shows both autosomal dominant and X-linked inheritance, and is due to deletions of, or mutations in, the short stature homeobox (*SHOX*) gene, located in the pseudoautosomal region (p. 122).

### Sex Influence

Some autosomal traits are expressed more frequently in one sex than in another—so-called **sex influence**. In males, gout and presenile baldness are examples of sex-influenced autosomal dominant traits, probably through the effect of male hormones. Gout is very rare in women before the menopause but more frequent later; baldness does not occur in males who have been castrated. In hemochromatosis (p. 267), the most common autosomal recessive disorder in Western society, homozygous females are much less likely than homozygous males to develop iron overload and associated symptoms; the explanation usually given is that women have a form of natural blood loss through menstruation.

### Sex Limitation

**Sex limitation** refers to the appearance of certain features only in individuals of a particular sex. Examples include virilization of female infants affected with the autosomal recessive endocrine disorder, congenital adrenal hyperplasia (p. 261).

## Establishing the Mode of Inheritance of a Genetic Disorder

In human and clinical genetics, when a likely genetic condition is being assessed, the geneticist relies heavily on pedigree information, and subsequently molecular genetic testing, to try and establish the inheritance pattern. This is not necessarily straightforward with a single family and may be greatly helped by studying several families with the same condition or phenotype ([Box 6.1](#)).

### Autosomal Dominant Inheritance

Three specific features are looked for: (1) the condition affects both males and females in equal proportions; (2) it is transmitted from one generation to the next; (3) all forms of transmission between the sexes are observed (i.e., male to male, female to female, male to female, and female to male). Male-to-male transmission excludes the possibility of the gene being on the X chromosome.

### Autosomal Recessive Inheritance

Again, three features suggest the possibility of autosomal recessive inheritance: (1) the disorder affects males and females in equal proportions; (2) it usually affects only individuals in one generation in a single sibship (i.e., brothers and sisters) and does not occur in previous and subsequent generations; (3) consanguinity in the parents provides further support.

### X-Linked Recessive Inheritance

Three main features are necessary to establish X-linked recessive inheritance: (1) the trait or disorder should affect males

### Box 6.1 Features That Support the Single-Gene or Mendelian Patterns of Inheritance

#### Autosomal Dominant

Males and females affected in equal proportions  
Affected individuals in multiple generations  
Transmission by individuals of both sexes (i.e., male to male, female to female, male to female, and female to male)

#### Autosomal Recessives

Males and females affected in equal proportions  
Affected individuals usually in only a single generation  
Parents can be related (i.e., consanguineous)

#### X-Linked Recessive

Only males usually affected  
Transmitted through unaffected females  
Males cannot transmit the disorder to their sons (i.e., no male-to-male transmission)

#### X-Linked Dominant

Males and females affected but often an excess of females  
Females less severely affected than males  
Affected males can transmit the disorder to their daughters but not to sons

#### Y-Linked Inheritance

Affected males only  
Affected males must transmit it to their sons

almost exclusively; (2) the disorder is transmitted through unaffected carrier females to their sons, and affected males, if they survive to reproduce, can have affected grandsons through their daughters who are obligate carriers; (3) male-to-male transmission is not observed.

### X-Linked Dominant Inheritance

Again, three key features: (1) males and females are affected but there are more affected females than males; (2) females are usually less severely affected than males; (3) although affected females can transmit the disorder to both male and female offspring, affected males transmit the disorder only to their daughters (except in partial sex-linkage; see p. 74), all of whom will be affected. In the case of X-linked dominant disorders that are almost invariably lethal in male embryos (e.g., incontinentia pigmenti; see pp. 73–74), only females will be affected and families may show an excess of females over males as well as a number of male gender miscarriages.

### Y-Linked Inheritance

Here, two features help to establish Y-linked inheritance: (1) it affects only males; (2) affected males must transmit the disorder only to their sons.

## Multiple Alleles and Complex Traits

So far, we have considered traits involving only two alleles—the normal, and the mutant, or variant. However, some traits and diseases are neither **monogenic** nor **polygenic**. Some genes have more than two allelic forms (i.e., multiple alleles). Multiple alleles are the result of a normal gene having mutated to produce various different alleles, some of which can be dominant and others recessive to the normal allele. In the ABO blood group system (p. 174) there are at least four alleles ( $A_1$ ,  $A_2$ , B, and O). An individual can possess any two of these alleles, which may be the same or different (AO,  $A_2$ B, OO, and

so on). Alleles are carried on homologous chromosomes and therefore a person transmits only one allele for a certain trait to any particular offspring. For example, a person with the genotype AB will transmit either the A allele or the B allele to offspring, but never both (Table 6.1). This relates only to autosomal genes, not those on the X chromosome, where males have only one allele to transmit.

Modern genome-wide scanning techniques, whole exome and whole genome sequencing, are making it possible to investigate so-called **complex traits**—conditions that are usually much more common than mendelian disorders and likely to be due to the interaction of more than one gene. The effects may be additive, one may be rate limiting over the action of another, or one may enhance or multiply the effect of another (see Chapter 10). The possibility of a small number of gene loci being implicated in some disorders has given rise to the concept of **oligogenic** inheritance, examples of which include the following.

### Digenic Inheritance

This refers to the situation where a disorder has been shown to be due to the additive effects of heterozygous mutations at two *different* gene loci. This is seen in certain transgenic mice. Mice that are homozygotes for *rv* (rib-vertebrae) or *Dll1* (*Delta-like-1*) manifest abnormal phenotypes, whereas their respective heterozygotes are normal. However, mice that are **double heterozygotes** for *rv* and *Dll1* show vertebral defects. In humans, one form of retinitis pigmentosa, a disorder of progressive visual impairment, is caused by double heterozygosity for mutations in two unlinked genes, *ROM1* and *PRPH2* (*Peripherin*), which both encode proteins present in photoreceptors. Individuals with only one of these mutations are not affected. In the field of inherited cardiac arrhythmias and cardiomyopathies (p. 290), it is becoming clear that digenic inheritance may be essential to causing the phenotype, thus complicating genetic counseling. Inherited deafness, Bardet-Biedl syndrome, and Joubert syndrome are all further examples of a growing list of conditions sometimes demonstrating digenic inheritance.

Other patterns of inheritance that are not classically mendelian are also recognized and explain some unusual phenomena.

### Anticipation

In some autosomal dominant traits or disorders, such as myotonic dystrophy, the onset of the disease occurs at an earlier

**Table 6.1** Possible Genotypes, Phenotypes, and Gametes Formed From the Four Alleles  $A_1$ ,  $A_2$ , B, and O at the ABO Locus

Genotype	Phenotype	Gametes
$A_1A_1$	$A_1$	$A_1$
$A_2A_2$	$A_2$	$A_2$
BB	B	B
OO	O	O
$A_1A_2$	$A_1$	$A_1$ or $A_2$
$A_1B$	$A_1B$	$A_1$ or B
$A_1O$	$A_1$	$A_1$ or O
$A_2B$	$A_2B$	$A_2$ or B
$A_2O$	$A_2$	$A_2$ or O
BO	B	B or O

age in the offspring than in the parents, or the disease occurs with increasing severity in subsequent generations. This is called **anticipation**. Prior to the modern era many believed this observation was due to bias of ascertainment, i.e. the way families were collected. It was argued that persons in whom the disease begins earlier, or is more severe, are more likely to be ascertained, and only those individuals who are less severely affected tend to have children. In addition, it was thought that, because the observer is in the same generation as the affected presenting probands, many individuals who at present are unaffected will, by necessity, develop the disease later in life.

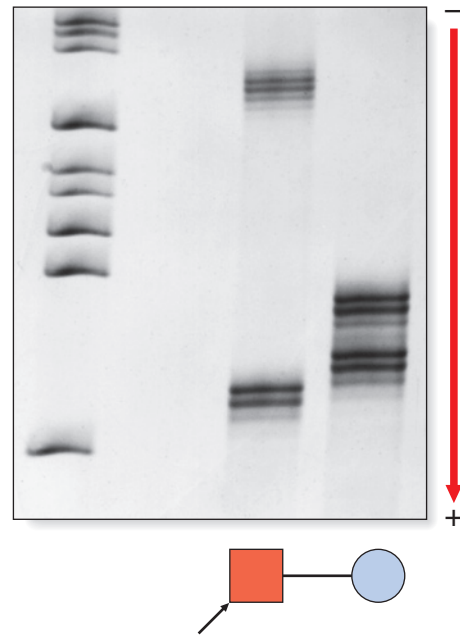
However, anticipation was shown to have a real biological basis, occurring as a result of the expansion of unstable triplet repeat sequences (p. 18). An expansion of the CTG triplet repeat in the 3' untranslated end of the myotonic dystrophy gene, occurring predominantly in **maternal** meiosis, appears to be the explanation for the severe neonatal form of myotonic dystrophy that usually only occurs when the gene is transmitted by the mother (Figure 6.19). Fragile X syndrome (CGG repeats) (p. 241) behaves in a similar way, with major instability in the expansion occurring during **maternal** meiosis. A similar expansion—in this case CAG repeats—in the 5' end of the Huntington disease gene (Figure 6.20) in **paternal** meiosis accounts for the increased risk of early onset Huntington disease, occasionally in childhood or adolescence, when the gene is transmitted by the father. The inherited spinocerebellar ataxia group of conditions (p. 274) is another example.

## Mosaicism

An individual, or a particular tissue of the body, can consist of more than one cell type or line, through an error occurring during mitosis at any stage after conception. This is known as **mosaicism** (p. 40). Mosaicism of either somatic tissues or germ cells can account for some instances of unusual patterns of inheritance or phenotypic features in an affected individual.



**FIGURE 6.19** Newborn baby with severe hypotonia requiring ventilation as a result of having inherited myotonic dystrophy from his mother.



**FIGURE 6.20** Silver staining of a 5% denaturing gel of the polymerase chain reaction products of the CAG triplet in the coding sequence of the *Huntingtin* (*HTT*) gene from an affected male and his wife, showing her to have two similar-sized repeats in the normal range (20 and 24 copies) and him to have one normal-sized triplet repeat (18 copies) and an expanded triplet repeat (44 copies). The bands in the left lane are standard markers to allow sizing of the CAG repeat. (Courtesy Alan Dodge, Regional DNA Laboratory, St. Mary's Hospital, Manchester, UK.)

## Somatic Mosaicism

The possibility of somatic mosaicism is suggested by the features of a single-gene disorder being less severe in an individual than is usual, or by being confined to a particular part of the body in a segmental distribution; for example, as occurs occasionally in neurofibromatosis type I (p. 278). The timing of the mutation event in early development may determine whether it is transmitted to the next generation with full expression—this will depend on the mutation being present in all or some of the gonadal tissue, and hence germline cells.

## Gonadal Mosaicism

There have been many reports of families with autosomal dominant disorders, such as achondroplasia and osteogenesis imperfecta, and X-linked recessive disorders, such as Duchenne muscular dystrophy and hemophilia, in which the parents are phenotypically normal, and the results of genetic tests also normal, but in which more than one of their children has been affected. The most favored explanation for these observations is gonadal, or germline, mosaicism in one of the parents, i.e., the mutation is present in a proportion of the gonadal or germline cells. An elegant example of this was provided by the demonstration of a mutation in the collagen gene responsible for osteogenesis imperfecta in a proportion of individual sperm from a clinically normal father who had two affected infants with different partners. It is important to keep germline mosaicism in mind when providing recurrence risks in genetic counseling for apparently new autosomal dominant and X-linked recessive mutations.

## Uniparental Disomy

An individual normally inherits one of a pair of homologous chromosomes from each parent. Occasionally, however, individuals inherit both homologs of a chromosome pair from only one parent, so-called **uniparental disomy (UPD)**. If an individual inherits two copies of the same homolog from one parent, through an error in meiosis II (p. 32), this is called **uniparental isodisomy** (Figure 6.21). If, however, the individual inherits the two different homologs from one parent through an error in meiosis I (p. 30), this is termed **uniparental heterodisomy**. In either instance, it is presumed that the conceptus would originally be trisomic, with early loss of a chromosome leading to the 'normal' disomic state. One-third of such chromosome losses, if they occurred with equal frequency, would result in UPD. Alternatively, it is postulated that UPD could arise as a result of a gamete from one parent that does not contain a particular chromosome homolog (i.e., a gamete that is **nullisomic**), being 'rescued' by fertilization with a gamete that, through a second separate chance error in meiosis, is disomic.

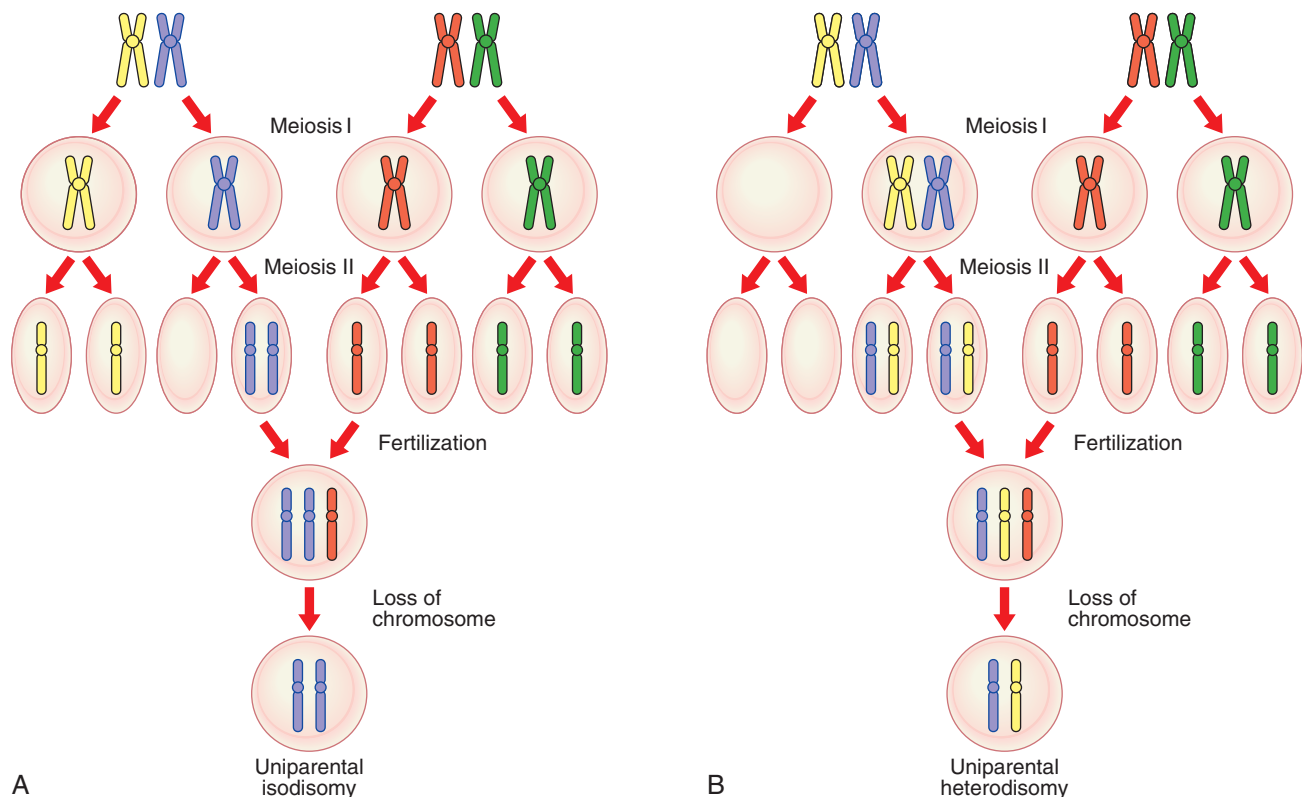
UPD has been shown to be the cause of a father with hemophilia having an affected son, and of a child with cystic fibrosis being born to a couple in which only the mother was a carrier (with proven paternity). UPD for chromosome 15 gives rise to either Prader-Willi syndrome (maternal UPD) or Angelman syndrome (paternal UPD), and paternal UPD for chromosome 11 is one of the causes of the overgrowth condition

known as the Beckwith-Wiedemann syndrome (see the following section).

## Genomic Imprinting

Genomic imprinting is an **epigenetic** phenomenon, referred to in Chapter 9 (p. 121). Epigenetics and genomic imprinting give the lie to Thomas Morgan's quotation at the start of this chapter! Although it was originally thought that genes on homologous chromosomes were expressed equally, it is now recognized that different clinical features can result, depending on whether a gene is inherited from the father or from the mother. This 'parent of origin' effect is referred to as **genomic imprinting**, and **methylation** of DNA is the main mechanism by which expression is modified. Methylation is the **imprint** applied to certain DNA sequences in their passage through gametogenesis, although only a small proportion of the human genome is in fact subject to this process. The differential allele expression (i.e., maternal or paternal) may occur in all somatic cells, or in specific tissues or stages of development. Thus far, at least 80 human genes are known to be imprinted and the regions involved are known as differentially methylated regions (DMRs). These DMRs include imprinting control regions (ICRs) that control gene expression across imprinted domains.

Evidence of genomic imprinting has been observed in two pairs of well-known dysmorphic syndromes: Prader-Willi and Angelman syndromes (chromosome 15q), and Beckwith-Wiedemann and Russell-Silver syndromes (chromosome 11p).



**FIGURE 6.21** Mechanism of origin of uniparental disomy. **A**, Uniparental isodisomy occurring through a disomic gamete arising from non-disjunction in meiosis II fertilizing a monosomic gamete with loss of the chromosome from the parent contributing the single homolog. **B**, Uniparental heterodisomy occurring through a disomic gamete arising from non-disjunction in meiosis I fertilizing a monosomic gamete with loss of the chromosome from the parent contributing the single homolog.



FIGURE 6.22 Female child with Prader-Willi syndrome.

The mechanisms giving rise to these conditions, although complex, reveal much about imprinting and will therefore now be considered in a little detail.

### Prader-Willi Syndrome

Prader-Willi syndrome (PWS) (p. 244) occurs in approximately 1 in 20,000 births and is characterized by short stature, obesity, hypogonadism, and learning difficulty (Figure 6.22). Fifty to sixty percent of individuals with PWS can be shown to have an approximate 2 Mb interstitial deletion of the proximal region of chromosome 15q11-q13, visible by conventional cytogenetic means, and in a further 15% a submicroscopic deletion can be demonstrated by fluorescent in-situ hybridization (see p. 27) or molecular means. DNA analysis has revealed that the chromosome deleted is almost always the *paternally* derived homolog. Most of the remaining 25% to 30% of individuals with PWS, without a chromosome deletion, have been shown to have maternal uniparental disomy. Functionally, this

is equivalent to a deletion in the paternally derived chromosome 15.

It is now known that only the paternally inherited allele of this critical region of 15q11-q13 is expressed. The molecular organization of the region is shown in Figure 6.23. PWS is a multigene disorder and in the normal situation the small nuclear ribonucleoprotein polypeptide N (*SNRPN*) and adjacent genes (*MKRN3*, etc.) are paternally expressed. Expression is under the control of a specific ICR. Analysis of DNA from patients with PWS and various submicroscopic deletions enabled the ICR to be mapped to a segment of approximately 4 kb, spanning the first exon and promoter of *SNRPN* and upstream reading frame (*SNURF*). The 3' end of the ICR is required for expression of the paternally expressed genes and also the origin of the long *SNURF/SNRPN* transcript. The maternally expressed genes are not differentially methylated but they are silenced on the paternal allele, probably by an antisense RNA generated from *SNURF/SNRPN*. In normal cells, the 5' end of the ICR, needed for maternal expression and involved in Angelman syndrome (see hereafter), is methylated on the maternal allele.

### Angelman Syndrome

Angelman syndrome (AS) (p. 244) occurs in approximately 1 in 15,000 births and is characterized by epilepsy, severe learning difficulties, an unsteady or ataxic gait, and a happy affect (Figure 6.24). Approximately 70% of individuals with AS have been shown to have an interstitial deletion of the same 15q11-q13 region as is involved in PWS, but in this case on the *maternally* derived homolog. In a further 5% of individuals with AS, the syndrome can be shown to have arisen through paternal uniparental disomy. Unlike PWS, the features of AS arise through loss of a single gene, *UBE3A*. In up to 10% of individuals with AS, mutations have been identified in *UBE3A*, a ubiquitin ligase gene, which appears to be preferentially or exclusively expressed from the maternally derived chromosome 15 in brain. How mutations in *UBE3A* lead to the features seen in persons with AS is not clear, but could involve ubiquitin-mediated destruction of proteins in the central nervous system in development, particularly where *UBE3A* is expressed most strongly, namely the hippocampus and Purkinje cells of the cerebellum. *UBE3A* is under control of the AS ICR (see Figure 6.23), which was mapped slightly upstream of *SNURF/SNRPN*

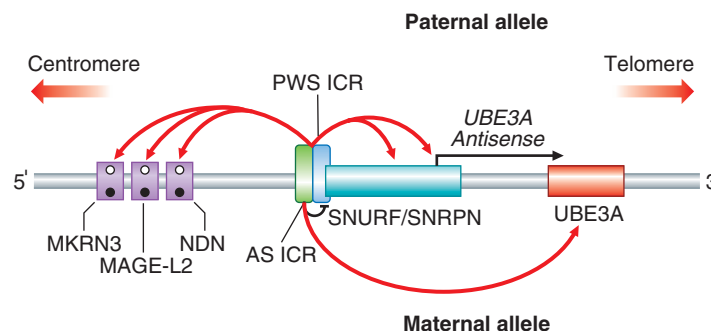


FIGURE 6.23 Molecular organization (simplified) at 15q11-q13: Prader-Willi syndrome (PWS) and Angelman syndrome (AS). The imprinting control region (ICR) for this locus has two components. The more telomeric acts as the PWS ICR and contains the promoter of *SNURF/SNRPN*. *SNURF/SNRPN* produces several long and complex transcripts, one of which is believed to be an RNA antisense inhibitor of *UBE3A*. The more centromeric ICR acts as the AS ICR on *UBE3A*, which is the only gene whose maternal expression is lost in AS. The AS ICR also inhibits the PWS ICR on the maternal allele. The PWS ICR also acts on the upstream genes *MKRN3*, *MAGE-L2*, and *NDN*, which are unmethylated (○) on the paternal allele but methylated (●) on the maternal allele.





FIGURE 6.24 **A & B**, Two young girls with Angelman syndrome. **C**, Adult male with Angelman syndrome.

through analysis of patients with AS who had various different microdeletions.

Approximately 2% of individuals with PWS, and approximately 5% of those with AS, have abnormalities of the ICR itself; these patients tend to show the mildest phenotypes. Patients in this last group, unlike the other three, have a risk of recurrence. In the case of AS, if the mother carries the same mutation as the child, the recurrence risk is 50%, but even if she tests negative for the mutation, there is an appreciable recurrence risk from gonadal mosaicism.

Rare families have been reported in which a translocation of the proximal portion of the long arm of chromosome 15 is segregating. Depending on whether the translocation is transmitted by the father or mother, affected offspring within the family have had either PWS or AS. In approximately 10% of AS cases the molecular defect is unknown—but it may well be that some of these alleged cases have a different, albeit phenotypically similar, diagnosis.

In most laboratories a simple DNA test is used to diagnose both PWS and AS, exploiting the differential DNA methylation characteristics at the 15q11-q13 locus (Figure 6.25).

### Beckwith-Wiedemann Syndrome

Beckwith–Wiedemann syndrome (BWS) is a clinically heterogeneous condition whose main underlying characteristic is overgrowth. First described in 1963 and 1964, the main features are macrosomia (prenatal and/or postnatal overgrowth), macroglossia (large tongue), abdominal wall defect (omphalocele, umbilical hernia, diastasis recti), and neonatal hypoglycemia (Figure 6.26). Hemihyperplasia may be present, as well as visceromegaly, renal abnormalities, ear anomalies (anterior earlobe creases, posterior helical pits) and cleft palate, and there may be embryonal tumors (particularly Wilms tumor).

BWS is known for the multiple different (and complex) molecular mechanisms that underlie it. Genomic imprinting, somatic mosaicism, and multiple genes are involved, all within a 1 Mb region at chromosome 11p15 (Figure 6.27). Within this region lie two independently regulated imprinted domains. The more telomeric (differentially methylated region 1 [DMR1] under control of ICR1) contains paternally expressed *IGF2* (insulin growth factor 2) and maternally expressed *H19*. The

more centromeric imprinted domain (DMR2, under control of ICR2) contains the maternally expressed *KCNQ1* (previously known as *KvLQT1*) and *CDKN1C* genes, and the paternally expressed antisense transcript *KCNQ1OT1*, the promoter for which is located within the *KCNQ1* gene.

Disruption to the normal regulation of methylation can give rise to altered gene expression dosage and, consequentially, features of BWS. In DMR1, **gain of methylation** on the maternal allele leads to loss of *H19* expression and biallelic *IGF2* expression (i.e., effectively two copies of the paternal epigenotype). This occurs in up to 7% of BWS cases and is usually

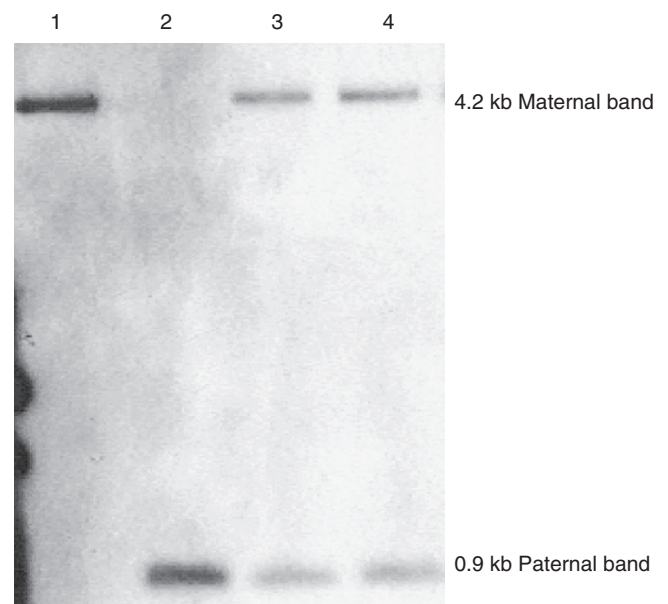


FIGURE 6.25 Southern blot to detect methylations of *SNRPN*. DNA digested with *Xba I* and *Not I* was probed with KB17, which hybridizes to a CpG island within exon a of *SNRPN*. Patient 1 has Prader-Willi syndrome, patient 2 has Angelman syndrome, and patients 3 and 4 are unaffected. (Courtesy A. Gardner, Department of Molecular Genetics, Southmead Hospital, Bristol.)



**FIGURE 6.26** Baby girl with Beckwith-Wiedemann syndrome. Note the large tongue and umbilical hernia.

sporadic. In DMR2, **loss of methylation** results in two copies of the paternal epigenotype and a reduction in expression of *CDKN1C*; this mechanism is implicated in 50% to 60% of sporadic BWS cases. *CDKN1C* may be a growth inhibitory gene and mutations have been found in 5% to 10% of cases of BWS. Approximately 15% of BWS cases are familial, and *CDKN1C* mutations are found in approximately half of these. In addition to imprinting errors in DMR1 and DMR2, other mechanisms may account for BWS: (1) paternally derived duplications of chromosome 11p15.5 (these cases were the first to identify the BWS locus); (2) paternal uniparental disomy for chromosome 11—invariably present in mosaic form—often associated with neonatal hypoglycemia and hemihypertrophy, and associated with the highest risk (approximately 25%) of embryonal tumors, particularly Wilms tumor; and (3) maternally inherited balanced translocations involving rearrangements of 11p15.

### Russell–Silver Syndrome

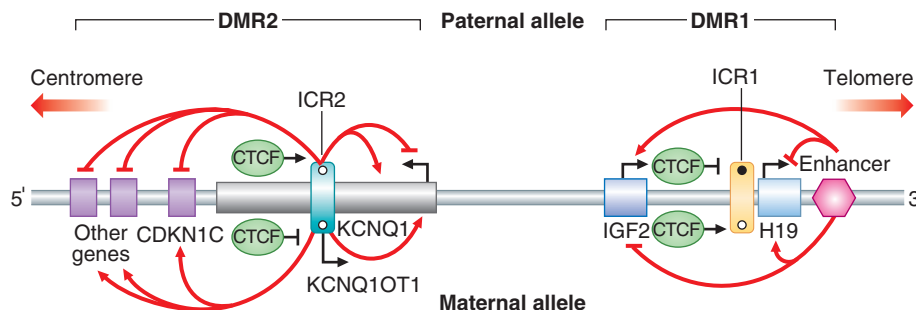
This well-known condition has ‘opposite’ characteristics to BWS by virtue of marked prenatal and postnatal growth retardation. The head circumference is relatively normal, the face rather small and triangular, giving rise to a ‘pseudohydrocephalic’ appearance (Figure 6.28), and there may be body asymmetry. Approximately 10% of cases appear to be due to maternal uniparental disomy, indicating that this chromosome is subject to imprinting. In contrast to paternally derived duplications of 11p15, which give rise to overgrowth and BWS, maternally derived duplications of this region are associated with growth retardation. Recently it has been shown that approximately one third of Russell–Silver syndrome (RSS) cases are due to abnormalities of imprinting at the 11p15.5 locus. Whereas *hypermethylation* of DMR1 leads to upregulated *IGF2* and overgrowth, *hypomethylation* of *H19* leads to downregulated *IGF2*, the opposite molecular and biochemical consequence, and these patients have features of RSS. Interestingly, in contrast to BWS, there are no cases of RSS with altered methylation of the more centromeric DMR2 region.

### Mitochondrial Inheritance

Each cell contains thousands of copies of mitochondrial DNA with more being found in cells that have high energy requirements, such as brain and muscle. Mitochondria, and therefore their DNA, are inherited almost exclusively from the mother through the oocyte (p. 32). Mitochondrial DNA has a higher rate of spontaneous mutation than nuclear DNA, and the accumulation of mutations in mitochondrial DNA has been proposed as being responsible for some of the somatic effects seen with aging.

In humans, **cytoplasmic or mitochondrial inheritance** explains the pattern of inheritance observed in some rare disorders that affect both males and females but are transmitted only through females, so-called maternal or matrilineal inheritance (Figure 6.29).

A number of rare disorders with unusual combinations of neurological and myopathic features, sometimes occurring in association with other conditions such as cardiomyopathy and conduction defects, diabetes, or deafness, have been characterized as being due to mutations in mitochondrial genes (p. 269). Because mitochondria are crucial to cellular metabolism



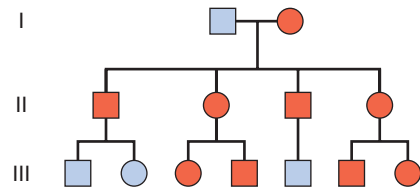
**FIGURE 6.27** Molecular organization (simplified) at 11p15.5: Beckwith-Wiedemann and Russell-Silver syndromes. The region contains two imprinted domains (DMR1 and DMR2) that are regulated independently. The ICRs are differentially methylated (● methylated; ○ unmethylated). CCCTC-binding factor (CTCF) binds to the unmethylated alleles of both ICRs. In DMR1, coordinated regulation leads to expression of *IGF2* only on the paternal allele and *H19* expression only on the maternal allele. In DMR2, coordinated regulation leads to *maternal* expression of *KCNQ1* and *CDKN1C* (plus other genes), and *paternal* expression of *KCNQ1OT1* (a non-coding RNA with antisense transcription to *KCNQ1*). Angled black arrows show the direction of the transcripts.



**FIGURE 6.28** Girl with Russell-Silver syndrome. Note the bossed forehead, triangular face, and 'pseudohydrocephalic' appearance.

through oxidative phosphorylation, it is not surprising that the organs most susceptible to mitochondrial mutations are the central nervous system, skeletal muscle and heart.

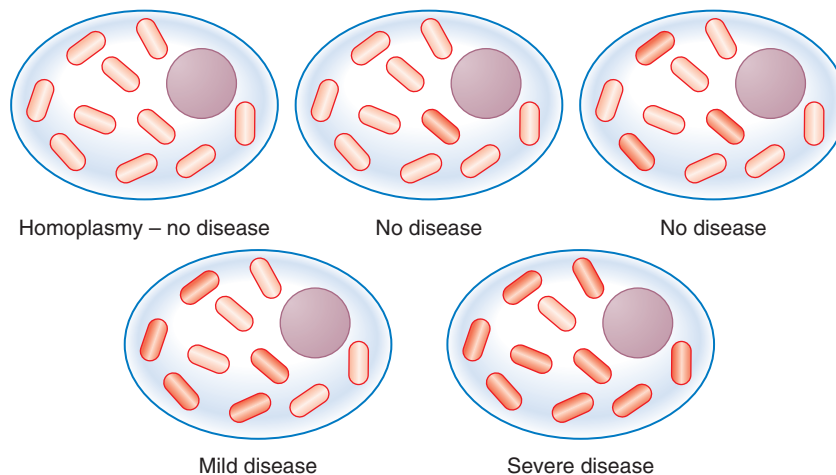
In most persons, the mitochondrial DNA from different mitochondria is identical, or shows what is termed **homoplasm**. If a mutation occurs in the mitochondrial DNA of an



**FIGURE 6.29** Family tree consistent with mitochondrial inheritance.

individual, initially there will be two populations of mitochondrial DNA, so-called **heteroplasm**. The proportion of mitochondria with a mutation in their DNA varies between cells and tissues, and this, together with mutational heterogeneity, explains the range of phenotypic severity seen in persons affected with mitochondrial disorders (**Figure 6.30**).

Whilst matrilineal inheritance applies to disorders that are directly due to mutations in mitochondrial DNA, it is also important to appreciate that mitochondrial **proteins** are encoded mainly by nuclear genes. Mutations in these genes can have a devastating impact on respiratory chain functions within mitochondria. Examples include genes encoding proteins within the cytochrome *c* (COX) system, for example *SURF1*, which follow autosomal recessive inheritance, and the *G4.5 (TAZ)* gene that is X-linked and causes Barth syndrome (endocardial fibroelastosis) in males. Mitochondrial myopathy following autosomal dominant inheritance, in which multiple mitochondrial DNA deletions can be detected, may be caused by mutations in *POLG* genes. Further discussion of mitochondrial disorders can be found in **Chapter 18** (p. 269).



**FIGURE 6.30** Progressive effects of heteroplasm on the clinical severity of disease from mutations in the mitochondrial genome. Low proportions of mutant mitochondria are tolerated well, but as the proportion increases different thresholds for cellular, and hence tissue, dysfunction are breached (mauve circle represents the cell nucleus).

## FURTHER READING

Bateson, W., Saunders, E.R., 1902. Experimental studies in the physiology of heredity, pp 132–134. Royal Society Reports to the Evolution Committee, 1902.

*Early observations on mendelian inheritance.*

Bennet, R.L., Steinhaus, K.A., Urich, S.B., et al., 1995. Recommendations for standardized human pedigree nomenclature. *Am. J. Hum. Genet.* 56, 745–752.

Goriely, A., McVean, G.A.T., Rojmyr, M., et al., 2003. Evidence for selective advantage of pathogenic *FGFR2* mutations in the male germ line. *Science* 301, 643–646.

Hall, J.G., 1988. Somatic mosaicism: observations related to clinical genetics. *Am. J. Hum. Genet.* 43, 355–363.

*Good review of findings arising from somatic mosaicism in clinical genetics.*

Hall, J.G., 1990. Genomic imprinting: review and relevance to human diseases. *Am. J. Hum. Genet.* 46, 857–873.

*Extensive review of examples of imprinting in inherited diseases in humans.*

Heinig, R.M., 2000. The monk in the garden: the lost and found genius of Gregor Mendel. Houghton Mifflin, London.

*The life and work of Gregor Mendel as the history of the birth of genetics.*

Kingston, H.M., 1994. An ABC of clinical genetics, second ed. British Medical Association, London.

*A simple outline primer of the basic principles of clinical genetics.*

Reik, W., Surami, A. (Eds.), 1997. Genomic imprinting (frontiers in molecular biology). IRL Press, London.

*Detailed discussion of examples and mechanisms of genomic imprinting.*

Schäffer, A.A., 2013. Digenic inheritance in medical genetics. *J. Med. Genet.* 50, 641–652.

## ELEMENTS

- 1 Family studies are usually necessary to determine the mode of inheritance of a trait or disorder and to give appropriate genetic counseling. A standard shorthand convention exists for pedigree documentation of the family history.
- 2 Mendelian, or single-gene, disorders can be inherited in five ways: autosomal dominant, autosomal recessive, X-linked dominant, X-linked recessive and, rarely, Y-linked inheritance.
- 3 Autosomal dominant alleles are manifest in the heterozygous state and are usually transmitted from one generation to the next but also arise as a new mutation. They usually affect both males and females equally. Each offspring of a parent with an autosomal dominant gene has a 1 in 2 chance of inheriting it from the affected parent. Autosomal dominant alleles can exhibit reduced penetrance, variable expressivity, and sex limitation.
- 4 Autosomal recessive disorders are manifest only in the homozygous state and normally only affect individuals in one generation, usually in one sibship in a family. They affect both males and females equally. Offspring of parents who are heterozygous for the same autosomal recessive allele have a 1 in 4 chance of being homozygous for that allele. The less common an autosomal recessive allele, the greater the likelihood that the parents of a homozygote are consanguineous.
- 5 X-linked recessive alleles are normally manifest only in males. Offspring of females heterozygous for an X-linked recessive allele have a 1 in 2 chance of inheriting the allele from their mother. Daughters of males with an X-linked recessive allele are obligate heterozygotes but sons cannot inherit the allele. Rarely, females manifest an X-linked recessive trait because they are homozygous for the allele, have a single X chromosome, have a structural rearrangement of one of their X chromosomes, or are heterozygous but show skewed or non-random X-inactivation.
- 6 Some disorders are inherited in an X-linked dominant manner. In X-linked dominant disorders, hemizygous males are usually more severely affected than heterozygous females.
- 7 Unusual features in single-gene patterns of inheritance can be explained by phenomena such as genetic heterogeneity, mosaicism, anticipation, imprinting, uniparental disomy, and mitochondrial inheritance.

# Population and Mathematical Genetics

In this chapter some of the more mathematical aspects of gene inheritance are considered, together with how genes are distributed and maintained at particular frequencies in populations. This subject constitutes what is known as **population genetics**. Genetics lends itself to a numerical approach, with many of the most influential and pioneering figures in human genetics having come from a mathematical background, attracted by the challenges of trying to determine the frequencies of genes in populations and the rates at which they mutate. This still has relevance for clinical genetics, particularly genetic risk counseling, and by the end of this chapter it is hoped that the reader will have gained an understanding of the following.

1. Why a dominant trait does not increase in a population at the expense of a recessive one.
2. How the carrier frequency and mutation rate can be determined from the disease incidence.
3. Why a particular genetic disorder can be more common in one population or community than another.
4. How it can be confirmed that a genetic disorder shows a particular pattern of inheritance.
5. The concept of genetic linkage and how this differs from linkage disequilibrium.
6. The potential effects of medical intervention on gene frequencies.

## Allele Frequencies in Populations

On first reflection, it would be reasonable to predict that dominant genes and traits in a population would tend to increase at the expense of recessive ones. On average, three-quarters of the offspring of two heterozygotes will manifest the dominant trait, but only one-quarter will have the recessive trait. It might be thought, therefore, that eventually almost everyone in the population would have the dominant trait. However, it can be shown that in a large randomly mating population, in which there is no disturbance by outside influences, dominant traits do not increase at the expense of recessive ones. In fact, in such a population, the relative proportions of the different genotypes (and phenotypes) remain constant from one generation to another. This is known as the Hardy-Weinberg principle, proposed independently by the English mathematician, G. H. Hardy, and a German physician, W. Weinberg, in 1908, and it remains important.

### The Hardy-Weinberg Principle

Consider an 'ideal' population in which there is an autosomal locus with two alleles, A and a, that have frequencies of  $p$  and  $q$ , respectively. These are the only alleles found at this locus, so that  $p + q = 100\%$ , or 1. The frequency of each genotype in the population can be determined by construction of a Punnett square, which shows how the different genes can combine (Figure 7.1).

*Do not worry about your difficulties in mathematics. I can assure you mine are still greater.*

ALBERT EINSTEIN

From Figure 7.1, it can be seen that the frequencies of the different genotypes are:

Genotype	Phenotype	Frequency
AA	A	$p^2$
Aa	A	$2pq$
Aa	A	$q^2$

If there is random mating of sperm and ova, the frequencies of the different genotypes in the first generation will be as shown. If these individuals mate with one another to produce a second generation, a Punnett square can again be used to show the different matings and their frequencies (Figure 7.2).

From Figure 7.2 the total frequency for each genotype in the second generation can be derived (Table 7.1). This shows that the relative frequency or proportion of each genotype is the same in the second generation as in the first. In fact, no matter how many generations are studied, the relative frequencies will remain constant. The actual numbers of individuals with each genotype will change as the population size increases or decreases, but their relative frequencies or proportions remain constant—the fundamental tenet of the Hardy-Weinberg principle. When epidemiological studies confirm that the relative proportions of each genotype remain constant with frequencies of  $p^2$ ,  $2pq$ , and  $q^2$ , then that population is said to be in Hardy-Weinberg equilibrium for that particular genotype.

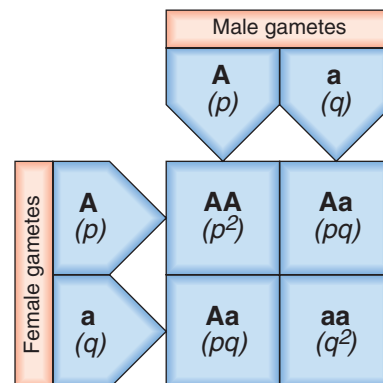


FIGURE 7.1 Punnett square showing allele frequencies and resulting genotype frequencies for a two-allele system in the first generation.

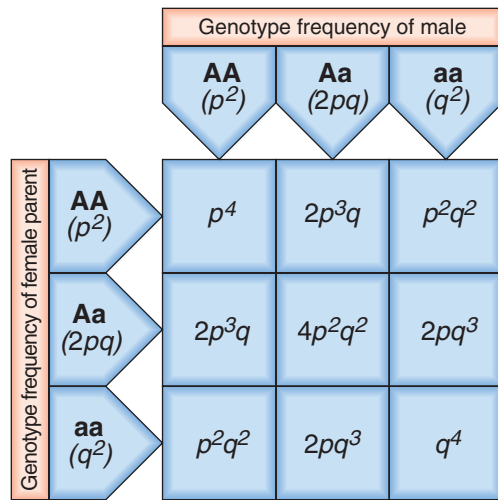


FIGURE 7.2 Punnett square showing frequencies of the different matings in the second generation.

### Factors That Can Disturb Hardy-Weinberg Equilibrium

So far, this relates to an ‘ideal’ population. By definition such a population is large and shows random mating with no new mutations and no selection for or against any particular genotype. For some human characteristics, such as neutral genes for blood groups or enzyme variants, these criteria can be fulfilled. However, several factors can disturb Hardy-Weinberg equilibrium, either by influencing the distribution of genes in the population or by altering the gene frequencies. These factors include:

1. Non-random mating
2. Mutation
3. Selection
4. Small population size
5. Gene flow (migration).

#### Non-Random Mating

Random mating, or panmixis, refers to the selection of a partner regardless of that partner’s genotype. Non-random mating can lead to an increase in the frequency of affected homozygotes by two mechanisms, either assortative mating or consanguinity.

#### Assortative Mating

This is the tendency for human beings to choose partners who share characteristics such as height, intelligence, and racial origin. If assortative mating extends to conditions such as

autosomal recessive (AR) deafness, which accounts for a large proportion of all congenital hearing loss, this will lead to a small increase in the relative frequency of affected homozygotes.

#### Consanguinity

Consanguinity is the term used to describe childbearing between blood relatives who have at least one common ancestor no more remote than a great-great-grandparent. Widespread consanguinity in a community will lead to a relative increase in the frequency of affected homozygotes but a relative decrease in the frequency of heterozygotes.

#### Mutation

The validity of the Hardy-Weinberg principle is based on the assumption that no new mutations occur. If a particular locus shows a high mutation rate, then there will be a steady increase in the proportion of mutant alleles in a population. In practice, mutations do occur at almost all loci, albeit at different rates, but the effect of their introduction is usually balanced by the loss of mutant alleles due to reduced fitness of affected individuals. If a population is found to be in Hardy-Weinberg equilibrium, it is generally assumed that these two opposing factors have roughly equal effects—discussed further in the section that follows on the estimation of mutation rates.

#### Selection

In the ‘ideal’ population there is no selection for or against any particular genotype. In reality, for deleterious characteristics there is likely to be negative selection, with affected individuals having reduced reproductive (= biological = ‘genetic’) fitness. This implies that they do not have as many offspring as unaffected members of the population. In the absence of new mutations, this reduction in fitness will lead to a gradual reduction in the frequency of the mutant gene, and hence disturbance of Hardy-Weinberg equilibrium.

Selection can act in the opposite direction by increasing fitness. For some AR disorders there is evidence that heterozygotes show a slight increase in biological fitness compared with unaffected homozygotes—referred to as heterozygote advantage. The best understood example is sickle-cell disease, in which affected homozygotes have severe anemia and often show persistent ill-health (p. 158). However, heterozygotes are relatively immune to infection with *Plasmodium falciparum* malaria because their red blood cells undergo sickling and are rapidly destroyed when invaded by the parasite. In areas where this form of malaria is endemic, carriers of sickle-cell anemia (sickle cell trait), have a biological advantage compared with unaffected homozygotes. Therefore, in these regions the

Table 7.1 Frequency of the Various Types of Offspring From the Matings Shown in Figure 7.2

Mating Type	Frequency	Frequency of Offspring		
		AA	Aa	aa
AA × AA	$p^4$	$p^4$	—	—
AA × Aa	$4p^3q$	$2p^3q$	$2p^3q$	—
Aa × Aa	$4p^2q^2$	$p^2q^2$	$2p^2q^2$	$p^2q^2$
AA × aa	$2p^2q^2$	—	$2p^2q^2$	—
Aa × aa	$4pq^3$	—	$2pq^3$	$2pq^3$
aa × aa	$q^4$	—	—	$q^4$
Total		$p^2(p^2 + 2pq + q^2)$	$2pq(p^2 + 2pq + q^2)$	$q^2(p^2 + 2pq + q^2)$
Relative frequency		$p^2$	$2pq$	$q^2$

proportion of heterozygotes tends to increase relative to the proportions of normal and affected homozygotes, and Hardy-Weinberg equilibrium is disturbed.

### Small Population Size

In a large population, the numbers of children produced by individuals with different genotypes, assuming no alteration in fitness for any particular genotype, will tend to balance out, so that gene frequencies remain stable. However, in a small population it is possible that by random statistical fluctuation one allele could be transmitted to a high proportion of offspring by chance, resulting in changes in allele frequency from one generation to the next, resulting in Hardy-Weinberg disequilibrium. This is known as random genetic drift. In extreme cases one allele may be lost altogether, and the other 'fixed' (Figure 7.3).

### Gene Flow (Migration)

If new alleles are introduced into a population through migration and intermarriage, a change will occur in the relevant allele frequencies. This slow diffusion of alleles across racial or geographical boundaries is known as gene flow. The most widely quoted example is the gradient shown by the incidence of the B blood group allele throughout the world (Figure 7.4), which is thought to have originated in Asia and spread slowly westward from admixture through invasion.

### Validity of Hardy-Weinberg Equilibrium

It is relatively simple to establish whether a population is in Hardy-Weinberg equilibrium for a particular trait if all possible genotypes can be identified. Consider a system with two alleles, A and a, with three resulting genotypes, AA, Aa/aA, and aa. Among 1000 individuals selected at random, the following genotype distributions are observed:

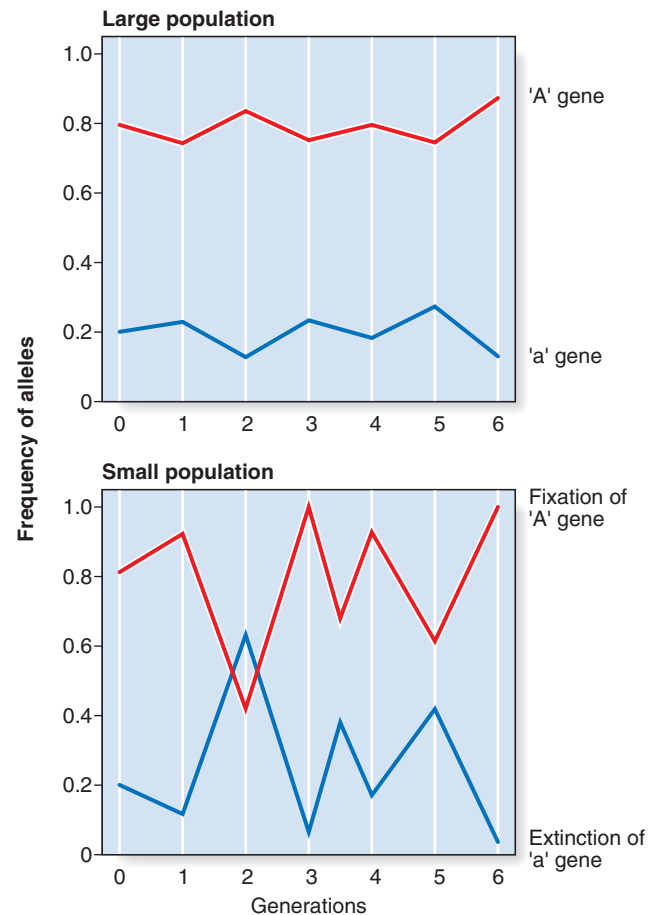


FIGURE 7.3 Possible effects of random genetic drift in large and small populations.

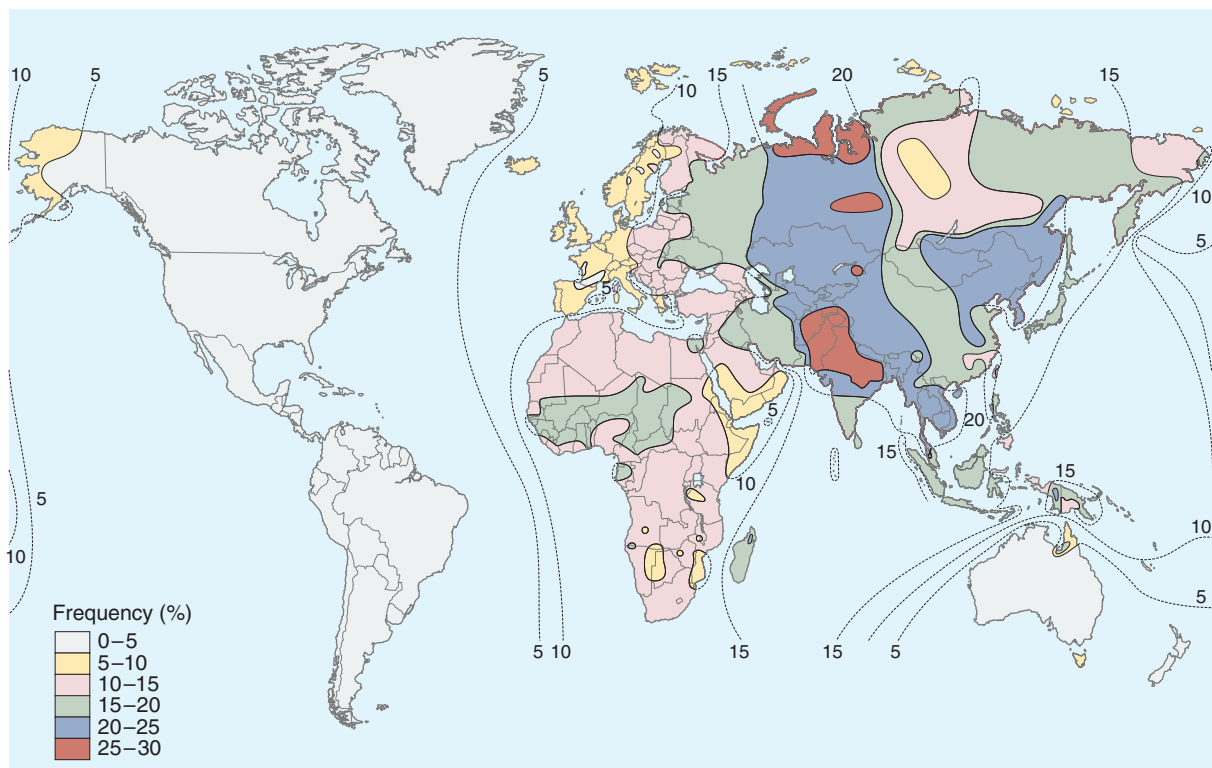


FIGURE 7.4 Distribution of blood group B throughout the world. (From Mourant AE, Kopéc AC, Domaniewska-Sobczak K 1976 *The distribution of the human blood groups and other polymorphisms*, 2nd ed. London: Oxford University Press, with permission.)

AA	800
Aa/aA	185
Aa	15

From these figures, the incidence of the 'A' allele (p) equals  $[(2 \times 800) + 185]/2000 = 0.8925$  and the incidence of the 'a' allele (q) equals  $[185 + (2 \times 15)]/2000 = 0.1075$ .

However, if the population were in Hardy-Weinberg equilibrium, the expected gene frequencies would be:

Genotype	Observed	Expected
AA	800	796.5 ( $p^2 \times 1000$ )
Aa/aA	185	192 ( $2pq \times 1000$ )
aa	15	11.5 ( $q^2 \times 1000$ )

The observed and expected allele frequencies can be statistically compared by a  $\chi^2$  test, which confirms that they do not differ significantly.

Next, consider a different system with two alleles, B and b. Among 1000 randomly selected individuals the observed genotype distributions are:

BB	430
Bb/bB	540
Bb	30

From these values, the incidence of the 'B' allele (p) equals  $[(2 \times 430) + 540]/2000 = 0.7$  and the incidence of the 'b' allele (q) equals  $[540 + (2 \times 30)]/2000 = 0.3$ .

Using these values for p and q, the observed and expected genotype distributions can be compared:

Genotype	Observed	Expected
BB	430	490 ( $p^2 \times 1000$ )
Bb/bB	540	420 ( $2pq \times 1000$ )
bb	30	90 ( $q^2 \times 1000$ )

These values differ significantly, with an increased number of heterozygotes at the expense of homozygotes. Such deviation from Hardy-Weinberg equilibrium should prompt a search for factors that could result in increased numbers of heterozygotes, such as heterozygote advantage or negative assortative mating—that is, the attraction of opposites!

Despite the number of factors that can disturb Hardy-Weinberg equilibrium, most populations are in equilibrium for most genetic traits, and significant deviations from expected genotype frequencies are unusual.

### Applications of Hardy-Weinberg Equilibrium

#### Estimation of Carrier Frequencies

If the incidence of an AR disorder is known, it is possible to calculate the carrier frequency using some relatively simple algebra. For example, if the disease incidence is 1 in 10,000, then  $q^2 = 1/10,000$  and  $q = 1/100$ . Because  $p + q = 1$ , therefore  $p = 99/100$ . The carrier frequency can then be calculated as  $2 \times 99/100 \times 1/100$  (i.e.,  $2pq$ ), which approximates to 1 in 50. Thus, a rough approximation of the carrier frequency can be obtained by doubling the square root of the disease incidence. Approximate values for gene frequency and carrier frequency derived from the disease incidence can be extremely useful in genetic risk counseling (p. 318) (Table 7.2). However, if the disease incidence includes cases resulting from a high proportion of consanguineous relationships, then it is not valid to use the Hardy-Weinberg principle to calculate heterozygote frequencies because consanguinity disturbs the equilibrium,

**Table 7.2** Approximate Values for Gene Frequency and Carrier Frequency Calculated From the Disease Incidence Assuming Hardy-Weinberg Equilibrium

Disease Incidence ( $q^2$ )	Gene Frequency (q)	Carrier Frequency ( $2pq$ )
1/1000	1/32	1/16
1/2000	1/45	1/23
1/5000	1/71	1/36
1/10,000	1/100	1/50
1/50,000	1/224	1/112
1/100,000	1/316	1/158

leading to a relative increase in the proportion of affected homozygotes.

For an X-linked recessive (XLR) disorder, the frequency of affected males equals the frequency of the mutant allele, q. Thus, for a trait such as red-green color blindness, which affects approximately 1 in 12 male western European whites,  $q = 1/12$  and  $p = 11/12$ . This means that the frequency of affected females ( $q^2$ ) and carrier females ( $2pq$ ) is  $1/144$  and  $22/144$ , respectively.

#### Estimation of Mutation Rates

##### Direct Method

If an autosomal dominant (AD) disorder shows full penetrance, and is therefore always expressed in heterozygotes, an estimate of its mutation rate can be made relatively easily by counting the number of new cases in a defined number of births. Consider a sample of 100,000 children, 12 of whom have the AD disorder achondroplasia (pp. 114–115). Only two of these children have an affected parent, so that the remaining 10 must have acquired their disorder as a result of new mutations. Therefore 10 new mutations have occurred among the 200,000 genes inherited by these children (because each child inherits two copies of each gene), giving a mutation rate of 1 per 20,000 gametes per generation. In fact, this example is unusual because all new mutations in achondroplasia occur on the paternally derived chromosome 4; therefore, the mutation rate is 1 per 10,000 in spermatogenesis and, as far as we know, zero in oogenesis.

##### Indirect Method

For an AD disorder with reproductive fitness (f) equal to zero, all cases must result from new mutations. If the incidence of a disorder is denoted as I and the mutation rate as  $\mu$ , then as each child inherits two alleles, either of which can mutate to cause the disorder, the incidence equals twice the mutation rate (i.e.,  $I = 2\mu$ ).

If fitness is greater than zero, and the disorder is in Hardy-Weinberg equilibrium, then genes lost through reduced fitness must be counterbalanced by new mutations. Therefore,  $2\mu = I(1 - f)$  or  $\mu = [I(1 - f)]/2$ .

Thus, if an estimate of genetic fitness can be made by comparing the average number of offspring born to affected parents, to the average number of offspring born to controls such as their unaffected siblings, it will be possible to calculate the mutation rate.

A similar approach can be used to estimate mutation rates for AR and XLR disorders. With an AR condition, two genes will be lost for each homozygote that fails to reproduce. These will be balanced by new mutations. Therefore,  $2\mu = I(1 - f) \times 2$  or  $\mu = I(1 - f)$ .



For an XLR condition with an incidence in males equal to  $IM$ , three X chromosomes are transmitted per couple per generation. Therefore,  $3\mu = I^M(1 - f)$  or  $\mu = [I^M(1 - f)]/3$ .

### Why Is It Helpful to Know Mutation Rates?

There is a tendency to either love or hate mathematical formulae but the link between mutation rates, disease incidence, and fitness does hold practical value.

#### Estimation of Gene Size

If a disorder has a high mutation rate the gene may be large. Alternatively, it may contain a high proportion of GC residues and be prone to copy error, or contain a high proportion of repeat sequences (p. 16), which could predispose to misalignment in meiosis resulting in deletion and duplication.

#### Determination of Mutagenic Potential

Accurate methods for determining mutation rates may be useful in relation to predicted and observed differences in disease incidence in the aftermath of events such as nuclear accidents, for example Chernobyl in 1986 (p. 21).

#### Consequences of Treatment of Genetic Disease

As discussed later, improved treatment for serious genetic disorders may increase biological fitness, which may result in an increase in disease incidence.

### Why Are Some Genetic Disorders More Common Than Others?

It follows that if a gene has a high mutation rate, the disease incidence may be relatively high. However, factors other than the mutation rate and biological fitness may be involved, as mentioned previously. These are now considered in the context of population size.

#### Small Populations

Several rare AR disorders show a relatively high incidence in certain population groups (Table 7.3). High allele frequencies are usually explained by the combination of a founder effect together with social, religious, or geographical isolation—hence

the term genetic isolates. In some situations, genetic drift may have played a role.

For example, several very rare AR disorders occur at relatively high frequency in the Old Order Amish living in Pennsylvania—Christians originating from the Anabaptist movement who fled Europe during religious persecution in the eighteenth century. Original founders of the group must have carried abnormal alleles that became established at relatively high frequency due to the restricted number of partners available to members of the community.

Founder effects can also be observed in AD disorders. Variegate porphyria, which is characterized by photosensitivity and drug-induced neurovisceral disturbance, has a high incidence in the Afrikaner population of South Africa, traceable to one of two early Dutch settlers having transmitted the condition to many descendants (p. 66).

Interestingly, the Hopi Indians of Arizona show a high incidence of albinism. Affected males were excused from outdoor farming activities because of the health and visual problems of bright sunlight, thus providing more opportunity to reproduce relative to unaffected group members.

#### Large Populations

When a serious AR disorder, resulting in reduced fitness in affected homozygotes, has a high incidence in a large population, the explanation is presumed to lie in either a very high mutation rate and/or a heterozygote advantage. The latter explanation is the more probable for most AR disorders (Table 7.4).

#### Heterozygote Advantage

For sickle cell (SC) anemia (p. 158) and thalassemia (p. 159), there is very good evidence that heterozygote advantage results from reduced susceptibility to *Plasmodium falciparum* malaria, as explained in Chapter 12. Americans of Afro-Caribbean origin are no longer exposed to malaria, so it would be expected that the frequency of the SC allele in this group would gradually decline. However, the predicted rate of decline is so slow that it will be many generations before it is detectable.

**Table 7.3** Rare Autosomal Recessive Disorders That Are Relatively Common in Certain Groups of People

Group	Disorder	Clinical Features
Finns	Congenital nephrotic syndrome	Edema, proteinuria, susceptibility to infection
	Aspartylglycosaminuria	Progressive mental and motor deterioration, coarse features
	Mulibrey nanism	Muscle, liver, brain and eye involvement
	Congenital chloride diarrhea	Reduced $Cl^-$ absorption, diarrhea
Amish	Diastrophic dysplasia	Progressive epiphyseal dysplasia with dwarfism and scoliosis
	Cartilage–hair hypoplasia	Dwarfism, fine, light-colored and sparse hair
	Ellis–van Creveld syndrome	Dwarfism, polydactyly, congenital heart disease
Hopi and San Blas Indians	Glutaric aciduria type 1	Episodic encephalopathy and cerebral palsy-like dystonia
	Albinism	Lack of pigmentation
Ashkenazi Jews	Tay-Sachs disease	Progressive mental and motor deterioration, blindness
	Gaucher disease	Hepatosplenomegaly, bone lesions, skin pigmentation
	Dysautonomia	Indifference to pain, emotional lability, lack of tears, hyperhidrosis
Karaite Jews	Werdnig-Hoffmann disease	Infantile spinal muscular atrophy
Afrikaners	Sclerosteosis	Tall stature, overgrowth of craniofacial bones with cranial nerve palsies, syndactyly
	Lipoid proteinosis	Thickening of skin and mucous membranes
Ryukyuan Islands (off Japan)	'Ryukyuan' spinal muscular atrophy	Muscle weakness, club foot, scoliosis

**Table 7.4** Presumed Increased Resistance in Heterozygotes That Could Account for the Maintenance of Various Genetic Disorders in Certain Populations

Disorder	Genetics	Region/Population	Resistance or Advantage
Sickle-cell disease	AR	Tropical Africa	Falciparum malaria
$\alpha$ - and $\beta$ -thalassemia	AR	Southeast Asia and the Mediterranean	Falciparum malaria
G6PD deficiency	XLR	Mediterranean	Falciparum malaria
Cystic fibrosis	AR	Western Europe	Tuberculosis? The plague? Cholera?
Tay-Sachs disease	AR	Eastern European Jews	Tuberculosis?
Congenital adrenal hyperplasia	AR	Yupik Eskimos	Influenza B
Type 2 diabetes	AD	Pima Indians and others	Periodic starvation
Phenylketonuria	AR	Western Europe	Spontaneous abortion rate lower?

AR, Autosomal recessive; XLR, X-linked recessive; AD, autosomal dominant; G6PD, glucose 6-phosphate dehydrogenase.

For several AR disorders the mechanisms proposed for heterozygote advantage are largely speculative (see Table 7.4). The discovery of the cystic fibrosis (CF) gene, with the subsequent elucidation of the role of its protein product in membrane permeability (p. 286), supports the hypothesis of selective advantage through increased resistance to the effects of gastrointestinal infections, such as cholera and dysentery, in the heterozygote. This relative resistance could result from reduced loss of fluid and electrolytes. It is likely that this selective advantage was of greatest value several hundred years ago when these infections were endemic in Western Europe. If so, a gradual decline in the incidence of CF would be expected. However, if this theory is correct one has to ask why CF has not become relatively common in other parts of the world where gastrointestinal infections are endemic, particularly the tropics; in fact, the opposite is the case, for CF is rarer in these regions.

An alternative, but speculative, mechanism for the high incidence of a condition such as CF is that the mutant allele is preferentially transmitted at meiosis. This type of segregation distortion, whereby an allele at a particular locus is transmitted more often than would be expected by chance (i.e., in more than 50% of gametes), is referred to as meiotic drive. Firm evidence for this phenomenon in CF is lacking, although it has been demonstrated in the AD disorder myotonic dystrophy (p. 285).

A major practical problem when studying heterozygote advantage is that even a tiny increase in heterozygote fitness, compared with the fitness of unaffected homozygotes, can be sufficient to sustain a high allele frequency. For example, in CF, with an allele frequency of approximately 1 in 50, a heterozygote advantage of 2% to 3% would be sufficient to account for the high allele frequency.

## Genetic Polymorphism

Polymorphism is the occurrence in a population of two or more genetically determined forms (alleles, sequence variants) in such frequencies that the rarest of them could not be maintained by mutation alone. By convention, a polymorphic locus is one at which there are at least two alleles, each with a frequency greater than 1%. Alleles with frequencies of less than 1% are referred to as rare variants.

In humans, at least 30% of structural gene loci are polymorphic, with each individual being heterozygous at between 10% and 20% of all loci. Known polymorphic protein systems

include the ABO blood groups (p. 174) and many serum proteins, which may exhibit polymorphic electrophoretic differences—or isozymes.

DNA polymorphisms, including SNPs, have been crucial to positional cloning, gene mapping, the isolation of many disease genes (p. 43), studying population migrations, and forensic science. They are also used in gene tracking in the clinical context of preimplantation genetic diagnosis (p. 313) and exclusion testing. The value of a particular polymorphic system is assessed by determining its polymorphic information content (PIC). The higher the PIC value, the more likely it is that a polymorphic marker will be of value in various applications.

## Segregation Analysis

Segregation analysis refers to the study of the way in which a disorder is transmitted in families so as to establish the underlying mode of inheritance. The mathematical aspects of complex segregation analysis are far beyond the scope of this book—as well as many clinical geneticists! However, it is an important part of human genetics and some understanding of the principles involved, and the pitfalls, is relevant for the clinician meeting families.

## Autosomal Dominant Inheritance

For an AD disorder, the simplest approach is to compare the observed numbers of affected offspring born to affected parents with what would be expected based on the disease penetrance (i.e., 50% if penetrance is complete). A  $\chi^2$  test can be used to see whether the observed and expected numbers differ significantly. Care must be taken to ensure that a bias is not introduced by excluding parents who were ascertained through an affected child.

## Autosomal Recessive Inheritance

For disorders thought to follow AR inheritance, formal segregation analysis is much more difficult. This is because some couples who are both carriers will by chance not have affected children, and therefore not feature in ascertainment. To illustrate this, consider 64 possible sibships of size 3 in which both parents are carriers, drawn from a large hypothetical population (Table 7.5). The sibship structure shown in Table 7.5 is that which would be expected, on average.

In this population, on average, 27 of the 64 sibships will not contain any affected individuals. This can be calculated simply by cubing  $\frac{3}{4}$ —that is,  $\frac{3}{4} \times \frac{3}{4} \times \frac{3}{4} = \frac{27}{64}$ . Therefore, when the

**Table 7.5** Expected Sibship Structure in a Hypothetical Population That Contains 64 Sibships, Each of Size 3, in Which Both Parents Are Carriers of an Autosomal Recessive Disorder

Number of Affected in Sibship	Structure of Sibship	Number of Sibships	Number of Affected	Total Number of Sibs
3	■ ■ ■	1	3	3
2	■ ■ □	3	6	9
	□ ■ ■	3	6	9
	■ □ ■	3	6	9
1	■ □ □	9	9	27
	□ ■ □	9	9	27
	□ □ ■	9	9	27
	□ □ □	27	0	81
Total		64	48	192

If no allowance is made for truncate ascertainment, in that the 27 sibships with no affected cases will not be ascertained, then a falsely high segregation ratio of 48/111 (= 0.43) will be obtained.

families are analyzed, these 27 sibships containing only healthy individuals will not be ascertained—referred to as incomplete ascertainment. If this is not taken into account, a falsely high segregation ratio of 0.43 will be obtained instead of the correct value of 0.25.

Mathematical methods have been devised to cater for incomplete ascertainment, but analysis is usually further complicated by problems associated with achieving full or complete ascertainment. In practice, ‘proof’ of AR inheritance requires accurate molecular or biochemical markers for carrier detection. Affected siblings (especially when at least one is female) born to unaffected parents usually suggests AR inheritance, but somatic and germline parental mosaicism (p. 76), non-paternity, and other possibilities need to be considered. There are some good examples of conditions originally reported to follow AR inheritance but subsequently shown to be dominant with germline or somatic mosaicism; for example, osteogenesis imperfecta and pseudoachondroplasia. However, a high incidence of parental consanguinity undoubtedly provides strong

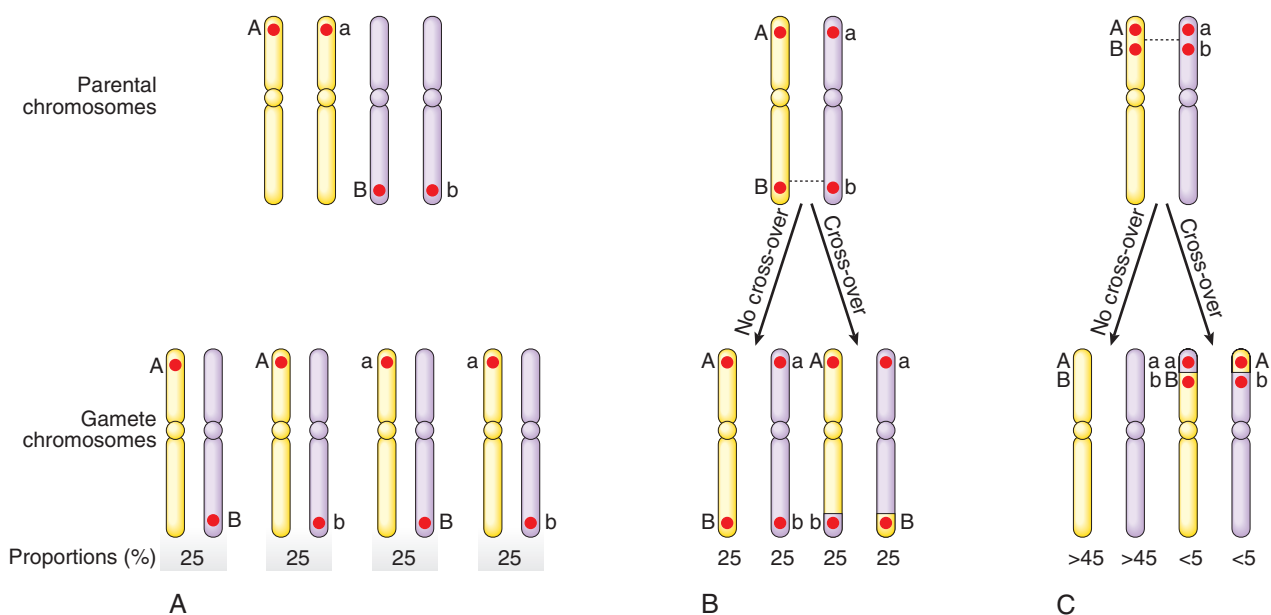
supportive evidence for AR inheritance, as first noted by Bateson and Garrod in 1902 (p. 4).

## Genetic Linkage

Mendel’s third law—the principle of independent assortment—states that members of different gene pairs assort to gametes independently of one another (p. 3). Stated more simply, the alleles of genes at different loci segregate independently. Although this is true for genes on different chromosomes, it is not always true for genes that are located on the same chromosome (i.e., close together, or syntenic).

Two loci positioned adjacent, or close, to each other on the same chromosome, will tend to be inherited together, and are said to be linked. The closer they are, the less likely they will be separated by a crossover, or recombination, during meiosis I (Figure 7.5).

Linked alleles on the same chromosome, and a pattern of associated markers, are known as the **linkage phase**. Thus in



**FIGURE 7.5** Segregation at meiosis of alleles at two loci. In **A** the loci are on different chromosomes and in **B** they are on the same chromosome but widely separated. Hence these loci are not linked and there is independent assortment. In **C** the loci are closely adjacent so that separation by a cross-over is unlikely (i.e., the loci are linked).

the parental chromosomes in Figure 7.5, C, A and B, as well as a and b, are in phase, whereas A and b, as well as a and B, are unlinked, in trans.

### Recombination Fraction

The recombination fraction, usually designated as  $\theta$  (Greek theta), is a measure of the distance separating two loci, or more precisely an indication of the likelihood that a cross-over will occur between them. If two loci are not linked then  $\theta$  equals 0.5 because, on average, genes at unlinked loci will segregate together during 50% of all meioses. If  $\theta$  equals 0.05, this means that on average the syntenic alleles will segregate together 19 times out of 20 (i.e., a crossover will occur between them during, on average, only 1 in 20 meioses).

### Centimorgans

The unit of measurement for genetic linkage is known as a map unit or centimorgan (cM). If two loci are 1 cM apart, a cross-over occurs between them, on average, only once in every 100 meioses (i.e.,  $\theta = 0.01$ ). Centimorgans are a measure of the genetic, or linkage, distance between two loci. This is not the same as physical distance, which is measured in base pairs (kb – kilobases: 1000 base pairs; Mb – megabases: 1,000,000 base pairs).

The human genome has been estimated by recombination studies to be approximately 3000 cM in length in males. Because the physical length of the haploid human genome is approximately  $3 \times 10^9$  bp, 1 cM corresponds to approximately  $10^6$  bp (1 Mb or 1000 kb). However, the relationship between linkage map units and physical length is not linear. Some chromosome regions appear to be particularly prone to recombination—so-called ‘hotspots’—and recombination occurs less often during meiosis in males than in females, in whom the genome ‘linkage’ length has been estimated to be 4200 cM. Generally, in humans one or two recombination events take place between each pair of homologous chromosomes in meiosis I, with a total of  $\sim 40$  across the entire genome. Recombination events are rare close to the centromeres but relatively common in telomeric regions.

### Linkage Analysis

Linkage analysis proved invaluable for mapping genes in the past (see Chapter 4) but is now largely redundant following complete sequencing of the human genome and next generation methodologies, though the principles still apply in genome-wide association studies. It is based on studying the segregation of the disease with polymorphic markers from each chromosome—preferably in large families. Eventually a marker will be identified that co-segregates with the disease more often than would be expected by chance (i.e., the marker and disease locus are linked). The mathematical analysis tends to be very complex, particularly if many closely adjacent markers are being used, as in multipoint linkage analysis. However, the underlying principle is relatively straightforward and involves the use of likelihood ratios, the logarithms of which are known as LOD scores (logarithm of the odds).

### LOD Scores

When studying the segregation of alleles at two loci that could be linked, a series of likelihood ratios is calculated for different values of the recombination fraction ( $\theta$ ), ranging from  $\theta = 0$  to  $\theta = 0.5$ . The likelihood ratio at a given value of  $\theta$  equals the likelihood of the observed data, if the loci are linked at

recombination value of  $\theta$ , divided by the likelihood of the observed data if the loci are not linked ( $\theta = 0.5$ ). The logarithm to the base 10 of this ratio is known as the LOD score (Z)—that is,  $\text{LOD}(\theta) = \log_{10} [L\theta/L(0.5)]$ . Logarithms are used because they allow results from different families to be added together.

For example, a LOD score (Z) of 4 at recombination fraction ( $\theta$ ) 0.05 means that the results, in the families studied, indicate that it is 10,000 ( $10^4$ ) times more likely that the disease and marker loci are closely linked (i.e., 5 cM apart) than that they are not linked. A LOD score of +3 or more would be confirmation of linkage, yielding a ratio of 1000 to 1 in favor of linkage; however, because there is a prior probability of only 1 in 50 that any two given loci are linked, a LOD score of +3 means that the overall probability that the loci are linked is approximately 20 to 1—that is,  $[1000 \times \frac{1}{50}] : 1$ . The importance of taking prior probabilities into account in probability theory is discussed in the section on Bayes’ theorem (p. 94).

#### 1. A ‘Simple’ Example

Consider a three-generation family in which several members have an AD disorder (Figure 7.6). A and B are alleles at a locus that is being tested for linkage to the disease locus.

To establish whether it is likely that these two loci are linked, the LOD score is calculated for various values of  $\theta$ . The value of  $\theta$  that gives the highest LOD score is taken as the best estimate of the recombination fraction. This is known as a **maximum likelihood method**.

To demonstrate the underlying principle, the LOD score is calculated for a value of  $\theta$  equal to 0.05. If  $\theta$  equals 0.05 then the loci are linked, in which case the disease gene and the B marker must be on the same chromosome in II2, as both of these characteristics have been inherited from the mother. Thus in II2 the linkage phase is known: the disease allele and the B allele are linked. Therefore the probability that III1 will be affected and will also inherit the B marker equals 0.95 (i.e.,  $1 - \theta$ ). A similar result is obtained for the remaining three members of the sibship in generation III, giving a value for the numerator of  $(0.95)^4$ . If the loci are not linked, the likelihood of observing both the disease and marker B in III1 equals 0.5. A similar result is obtained for his three siblings, giving a value for the denominator of  $(0.5)^4$ .

Therefore the LOD score for this family, given a value of  $\theta = 0.05$ , equals  $\log_{10} 0.954/0.54 = \log_{10} 13.032 = 1.12$ . For a value of  $\theta = 0$ , the LOD score equals  $\log_{10} 14/0.54$

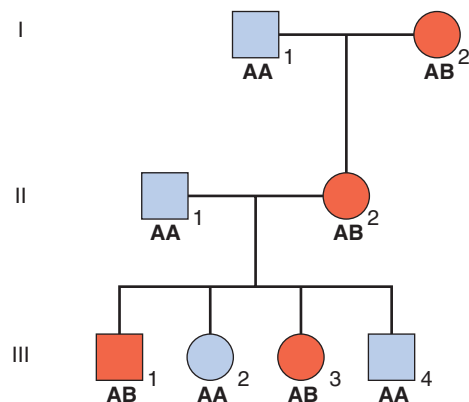


FIGURE 7.6 Three-generation pedigree showing segregation of an autosomal dominant disorder and alleles (A and B) at a locus that may or may not be linked to the disease locus.

$= \log_{10} 16 = 1.20$ . For a value of  $\theta = 0.1$ , the LOD score equals  $\log_{10} 0.94/0.54 = \log_{10} 10.498 = 1.02$ . The highest LOD score is obtained for a value of  $\theta$  equals 0, consistent with close linkage of the disease and marker loci, such that no recombination has occurred between the two loci in members of generation III.

To confirm linkage other families would have to be studied by pooling all the results until a LOD score of +3 or greater was obtained. A LOD score of  $-2$  or less is taken as proof that the loci are not linked. This less stringent requirement for proof of non-linkage (i.e., a LOD score of  $-2$  compared with +3 for proof of linkage) is due to the high prior probability of that any two loci are not linked.

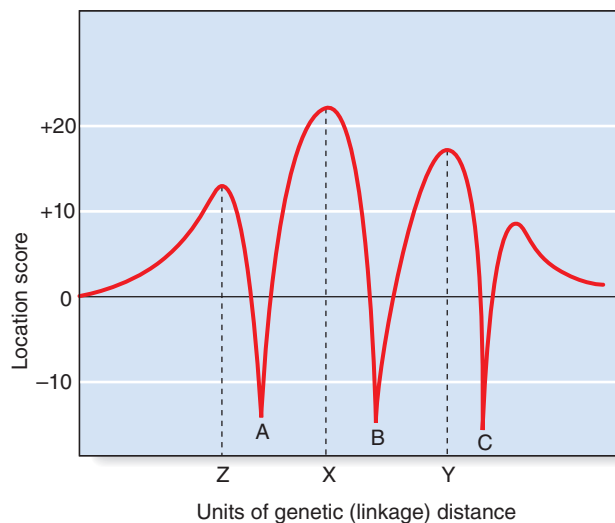
### Multipoint Linkage Analysis

Initial linkage results using a limited number of markers would be followed up a multipoint linkage analysis using a series of polymorphic markers known to map to the disease region, allowing fine tuning of the likely position of the disease locus within the interval previously defined. A computer program would then calculate the overall likelihood of the position of the disease locus in relation to the marker loci, and a graph constructed of the 'location score' against map distance (Figure 7.7). On this graph the peaks represent possible positions of the disease locus, with the tallest peak being the most probable location. The troughs represent the positions of the polymorphic marker loci.

Once the smallest interval for the disease locus was located, physical mapping methods were applied to identify the disease gene (see Chapter 4), though sophisticated sequencing methods are now used.

### Autozygosity Mapping

This form of linkage analysis has been used to map and identify many rare AR disorders. Autozygosity occurs when individuals are homozygous at particular loci by descent from a common ancestor. In an inbred pedigree containing two or more children with a rare AR disorder, it is very likely that the children will



**FIGURE 7.7** Multipoint linkage analysis. A, B, and C represent the known linkage relationships of three polymorphic marker loci. X, Y, and Z represent in descending order of likelihood the probable position of the disease locus.

be homozygous not only at the disease locus but also at closely linked loci. Thus, all affected relatives in an inbred family will be homozygous for markers close to the disease locus (Figure 7.8). By searching the genome for regions of homozygosity in the affected members of a sibship, and perhaps other affected relatives, only a small number of such regions will be identified. One of these can be expected to harbor the disease locus, and sequencing of candidate genes can go ahead.

Where more than one branch of a large inbred family can be studied, autozygosity is very powerful and many rare disease genes have been found in this way, for example, for AR sensorineural hearing loss, various skeletal dysplasias, and primary microcephalies.

### Linkage Disequilibrium

Linkage disequilibrium is defined formally as the association of two alleles at linked loci more frequently than would be expected by chance, and is also referred to as allelic association. The concept and the term relate to the study of diseases in populations rather than families. In the latter, an association between specific alleles and the disease in question holds true only within an individual family; in a separate affected family a different pattern of alleles, or markers, at the same locus may show association with the disease—because the alleles themselves are polymorphic.

The rationale for studying allelic association in populations is based on the assumption that a mutation occurred in a founder case some generations previously and is still causative of the disease. If this is true, the pattern of markers in a small region close to the mutation will have been maintained and thus constitutes what is termed the founder haplotype. The underlying principles used in mapping are the same as those for linkage analysis in families, the difference being the degree of relatedness of the individuals under study. In the pedigree shown in Figure 7.6, support was obtained for linkage of the disease gene with the B marker allele. If we assume that further studies confirm linkage of these loci and that the A and B alleles have an equal frequency of 0.5, it would be reasonable to expect that the disease gene is linked with allele A in approximately 50% of families and with allele B in the remaining 50%. If, however, the disease allele was found to be linked exclusively with one particular marker allele, this would be an example of linkage disequilibrium.

The demonstration of linkage disequilibrium in a particular disease suggests that the mutation causing the disease has occurred relatively recently and that the marker locus studied is very closely linked to the disease locus. There may be pitfalls, however, in interpreting haplotype data that suggest linkage disequilibrium. Other possible reasons for linkage disequilibrium include: (1) the rapid growth of genetically isolated populations leading to large regions of allelic association throughout the genome; (2) selection, whereby particular alleles enhance or diminish reproductive fitness; and (3) population admixture, where population subgroups with different patterns of allele frequencies are combined into a single study. Allowance for the latter problem can be made by using family-based controls and analyzing the transmission of alleles using a method called the transmission/disequilibrium test. This uses the fact that transmitted and non-transmitted alleles from a given parent are paired observations, and examines the preferential transmission of one allele over the other in all heterozygous parents. The method has been applied, for example, to studies of genetic conditions based on discordant sibling pairs.

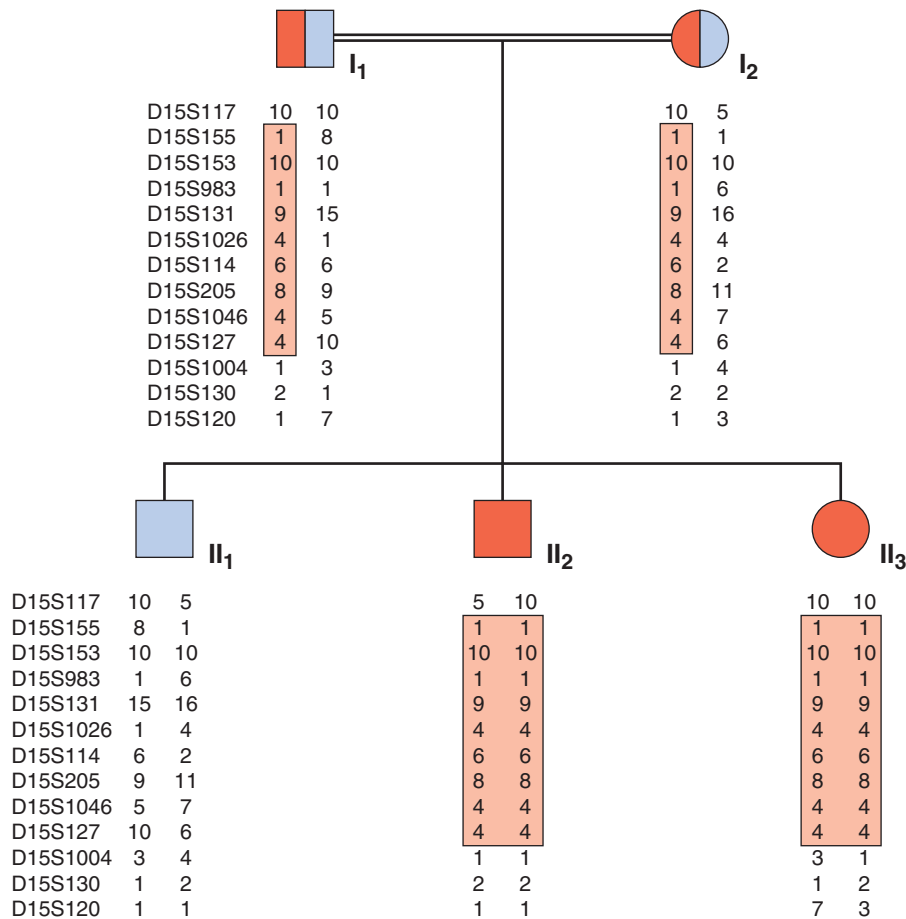


FIGURE 7.8 Autozygosity mapping in a family with spondylocostal dysostosis. The father of individual I1 is the brother of I2’s grandfather. The region of homozygosity is defined by markers D15S155 and D15S127. A mutation in the *MESP2* gene was subsequently shown to be the cause of spondylocostal dysostosis in this pedigree.

### Medical and Societal Intervention

The ability of modern medicine to enable patients with serious disease to live much longer raises the prospect that biological fitness may be increased, leading to increased numbers of ‘bad genes’ in society, potentially adding adversely to humanity’s future genetic load. Such long-term consequences generally carry no weight, however, and may in any case be offset by greater use of prenatal genetic testing, which for many is a focus of ethical concern (see Chapter 22). The ethical debate is very important but it is worth considering the possible long-term effects of artificial selection for or against genetic disorders, according to pattern of inheritance.

#### AD Disorders

If everyone with an AD disorder were successfully encouraged not to reproduce, the incidence of that disorder would decline rapidly, with all future cases being the result only of new mutations. This would have a particularly striking effect on the incidence of relatively mild conditions such as familial hypercholesterolemia, in which genetic fitness is close to 1.

Alternatively, if successful treatment became available for all patients with a serious AD disorder that at present is associated with a marked reduction in genetic fitness, there would be an immediate increase in the frequency of the disease gene followed by a more gradual leveling off at a new equilibrium level. If, at one time, all those with a serious AD disorder died

in childhood ( $f = 0$ ), then the incidence of affected individuals would be  $2\mu$ . If treatment raised the fitness from 0 to 0.9, the incidence of affected children in the next generation would rise to  $2\mu$  due to new mutations plus  $1.8\mu$  inherited, which equals  $3.8\mu$ . Eventually a new equilibrium would be reached, by which time the disease incidence would have risen tenfold to  $20\mu$ . This can be calculated relatively easily with the formula  $\mu = [I(1 - f)]/2$  (p. 86), which can also be expressed as  $I = 2\mu/(1 - f)$ . The net result would be that the proportion of affected children who died would be lower (from 100% down to 10%), but the total number affected would be much greater, although the actual number who died from the disease would remain unchanged at  $2\mu$ .

#### AR Disorders

In contrast to an AD disorder, artificial selection against an AR condition will have only a very slow effect. The reason for this difference is that in AR conditions most of the genes in a population are present in healthy heterozygotes who would not be affected by selection measures. It can be shown that if there is complete selection against an AR disorder, so that no homozygotes reproduce, the number of generations ( $n$ ) required for the allele frequency to change from  $q^0$  to  $q^n$  equals  $1/q^n - 1/q^0$ . Therefore, for a condition with an incidence of approximately 1 in 2000 and an allele frequency of roughly 1 in 45, if all affected patients refrained from reproduction then it would take more than 500 years (18

generations) to reduce the disease incidence by half, and more than 1200 years (45 generations) to reduce the gene frequency by half, assuming an average generation time of 27 years.

Now consider the opposite situation, where selection operating against a serious AR disorder is relaxed because of improvement in medical treatment. More affected individuals will reach adult life and transmit the mutant allele to their offspring. The result will be that the frequency of the mutant allele will increase until a new equilibrium is reached. Using the formula  $\mu = I(1 - f)$ , it can be shown that, when the new equilibrium is eventually reached, an increase in fitness from 0 to 0.9 will have resulted in a tenfold increase in the disease incidence.

### X-Linked Recessive Disorders

Here it is necessary to take into account the fact that a large proportion of the relevant genes are present in entirely healthy female carriers, who are often unaware of their carrier status. For a very serious condition, such as Duchenne muscular dystrophy (p. 281), with fitness equal to 0 in affected males, selection will have no effect unless female carriers choose to limit their families. If all female carriers opted not to have any children, the incidence would be reduced by two-thirds (i.e., from  $3\mu$  to  $\mu$ ).

More plausibly, effective treatment for these disorders may result in a steady increase in the disease incidence. For example, an increase in fitness from 0 to 0.5 will lead to a doubling of the disease incidence by the time a new equilibrium has been established. This can be calculated using the formula  $\mu = [I^M(1 - f)]/3$  (p. 86).

### Conclusion

In reality, it is extremely difficult to predict the long-term impact of medical intervention on the incidence and burden of genetic disease. Although it is true that improvements in medical treatment could result in an increased genetic load in future generations, it is also possible that successful therapies will ease the overall burden of these disorders in terms of human suffering. Some of these arguments applied to other major medical developments, such as immunisation and the discovery of insulin and antibiotics, which have had immeasurable financial implications in terms of the pharmaceutical industry as well as contributing to an aging population. Ultimately, how society copes with these advances and challenges provides a measure of civilization.

### FURTHER READING

Allison, A.C., 1954. Protection afforded by sickle-cell trait against subtertian malarial infection. *BMJ* 1, 290–294.

*A landmark paper providing clear evidence that the sickle-cell trait provides protection against parasitemia by falciparum malaria.*

Emery, A.E.H., 1986. *Methodology in medical genetics*, second ed. Churchill Livingstone, Edinburgh.

*A useful handbook of basic population genetics and mathematical methods for analyzing the results of genetic studies.*

Francomano, C.A., McKusick, V.A., Biesecker, L.G., eds, 2003. Medical genetic studies in the Amish: historical perspective. *Am. J. Med. Genet. C Semin. Med. Genet.* 121, 1–4.

Hardy, G.H., 1908. Mendelian proportions in a mixed population. *Science* 28, 49–50.

*A short letter in which Hardy pointed out that in a large randomly mating population dominant 'characters' would not increase at the expense of recessives.*

Khoury, M.J., Beaty, T.H., Cohen, B.H., 1993. *Fundamentals of genetic epidemiology*. Oxford University Press, New York.

*A comprehensive textbook of population genetics and its areas of overlap with epidemiology.*

Ott, J., 1991. *Analysis of human genetic linkage*. Johns Hopkins University Press, Baltimore.

*A detailed mathematical explanation of linkage analysis.*

Vogel, F., Motulsky, A.G., 1997. *Human genetics, problems and approaches*, third ed. Springer, Berlin.

*The definitive textbook of human genetics with extensive coverage of mathematical aspects.*

### ELEMENTS

- 1 According to the Hardy-Weinberg principle, the relative proportions of the possible genotypes at a particular locus remain constant from one generation to the next.
- 2 Factors that may disturb Hardy-Weinberg equilibrium are non-random mating, mutation, selection for or against a particular genotype, small population size, and migration.
- 3 If an autosomal recessive disorder is in Hardy-Weinberg equilibrium, the carrier frequency can be estimated by doubling the square root of the disease incidence.
- 4 The mutation rate for an autosomal dominant disorder can be measured directly by estimating the proportion of new mutations among all members of one generation. Indirect estimates of mutation rates can be made using the formula:
  - a. =  $[I(1 - f)]/2$  for autosomal dominant inheritance
  - b. =  $I(1 - f)$  for autosomal recessive inheritance
  - c. =  $[I^M(1 - f)]/3$  for X-linked recessive inheritance.
- 5 Otherwise rare single-gene disorders can show a high incidence in a small population because of a founder effect coupled with genetic isolation.
- 6 When a serious autosomal recessive disorder has a relatively high incidence in a large population, it is likely due to heterozygote advantage.
- 7 Closely adjacent loci on the same chromosome are regarded as linked if genes at these loci segregate together during more than 50% of meioses. The recombination fraction ( $\theta$ ) indicates how often two such genes will be separated (recombine) at meiosis.
- 8 The logarithm of the odds (LOD) score is a mathematical indication of the relative likelihood that two loci are linked. A LOD score of +3 or greater is taken as confirmation of linkage.
- 9 The principle of autozygosity (or homozygosity) mapping has facilitated the discovery of many genes for autosomal recessive disorders.

# Chapter 8

## Risk Calculation

*As far as the laws of mathematics refer to reality,  
they are not certain; and as far as they are  
certain, they do not refer to reality.*

ALBERT EINSTEIN

One of the most important aspects of genetic counseling (Chapter 21) is the provision of a risk figure, often referred to as **recurrence risk**. Estimation of the recurrence risk usually requires careful consideration and takes into account:

1. The diagnosis, its mode of inheritance, and epidemiological data relating to the natural history (e.g., age of onset)
2. Analysis of the family pedigree
3. The results of tests, which may include linkage studies using DNA markers or negative mutation analysis, and clinical data from standard investigations

Sometimes the provision of a risk figure can be quite easy, but a surprisingly large number of complicating factors arise that make the calculation very difficult. For example, the mother of a boy who is an isolated case of a sex-linked recessive disorder could very reasonably wish to know the recurrence risk for her next child. This is a very simple question, but the solution may be far from straightforward, as will become clear later in this chapter.

Before proceeding further, it is necessary to clarify what we mean by **probability** and review the different ways in which it can be expressed. The probability of an outcome can be defined as the number or, more correctly, the **proportion** of times it occurs in a large series of events. Conventionally, probability is indicated as a proportion of 1, so that a probability of 0 implies that an outcome will never be observed, whereas a probability of 1 implies that it will always be observed. Therefore, a probability of 0.25 indicates that, on average, a particular outcome or event will be observed on 1 in 4 occasions, or 25%. The probability that the outcome will not occur is 0.75, which can also be expressed as 3 chances out of 4, or 75%. Alternatively, this probability could be expressed as **odds** of 3 to 1 *against*, or 1 to 3 *in favor* of the particular outcome being observed. In this chapter, fractions are used where possible as these tend to be more easily understood than proportions of 1 expressed as decimals.

### Probability Theory

To calculate genetic risks it is necessary to have a basic understanding of probability theory. This will be discussed insofar as it is relevant to genetic counseling.

### Laws of Addition and Multiplication

When considering the probability of two different events or outcomes, it is essential to clarify whether they are mutually exclusive or independent. If the events are mutually exclusive,

then the probability that *either* one or the other will occur equals the sum of their individual probabilities. This is known as the **law of addition**.

If, however, two or more events or outcomes are independent, then the probability that *both* the first and the second will occur equals the **product** of their individual probabilities. This is known as the **law of multiplication**.

As a simple illustration of these laws, consider parents who have embarked upon their first pregnancy. The probability that the baby will be *either* a boy *or* a girl equals 1—i.e.,  $1/2 + 1/2$ . If the mother is found on ultrasonography to be carrying twins who are non-identical, then the probability that *both* the first *and* the second twin will be boys equals  $1/4$ —i.e.,  $1/2 \times 1/2$ .

### Bayes' Theorem

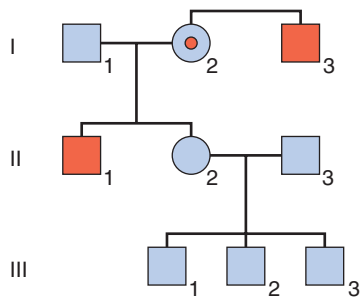
**Bayes' theorem**, first devised by Reverend Thomas Bayes (1702–1761) and published after his death in 1763, is widely used in genetic counseling. Essentially it provides a very valuable method for determining the overall probability of an event or outcome, such as carrier status, by considering all initial possibilities (e.g., carrier or non-carrier) and then modifying or 'conditioning' these by incorporating information, such as test results or pedigree information, that indicates which is the more likely. Thus, the theorem combines the probability that an event *will* occur with the probability that it *will not* occur. The theorem lay fairly dormant for a long time, but has been enthusiastically employed by geneticists. In recent years its simplicity and usefulness have been recognized in many other fields—for example, legal work, computing, and statistical analysis—such that it has truly come of age.

The initial probability of each event is known as its **prior probability**, and is based on ancestral or **anterior information**. The observations that modify these prior probabilities allow **conditional probabilities** to be determined. In genetic counseling these are usually based on numbers of offspring and/or the results of tests. This is **posterior information**. The resulting probability for each event or outcome is known as its **joint probability**. The final probability for each event is known as its **posterior or relative probability** and is obtained by dividing the joint probability for that event by the sum of all the joint probabilities.

This is not an easy concept to grasp! To make it easier, consider a pedigree with two males,  $I_3$  and  $II_1$ , who have a sex-linked recessive disorder (Figure 8.1). The sister,  $II_2$ , of one of these men wishes to know the probability that she is a carrier. Her mother,  $I_2$ , must be a carrier because she has both an affected brother and an affected son (i.e., she is an **obligate carrier**). Therefore, the prior probability that  $II_2$  is a carrier equals  $1/2$ . Similarly, the prior probability that  $II_2$  is not a carrier equals  $1/2$ .

The fact that  $II_2$  already has three healthy sons must be taken into consideration, as intuitively this makes it rather





**FIGURE 8.1** Pedigree showing sex-linked recessive inheritance. When calculating the probability that  $II_2$  is a carrier, it is necessary to take into account her three unaffected sons.

unlikely that she is a carrier. Bayes' theorem provides a way to quantify this intuition. These three healthy sons provide posterior information. The conditional probability that  $II_2$  will have three healthy sons if she is a carrier is  $1/2 \times 1/2 \times 1/2$ , which equals  $1/8$ . These values are multiplied as they are independent events, in that the health of one son is not influenced by the health of his brother(s). The conditional probability that  $II_2$  will have three healthy sons if she is not a carrier equals 1.

This information is now incorporated into a Bayesian calculation (Table 8.1). From this table, the posterior probability that  $II_2$  is a carrier equals  $1/16 / (1/16 + 1/2)$ , which reduces to  $1/9$ . Similarly the posterior probability that  $II_2$  is not a carrier equals  $1/2 / (1/16 + 1/2)$ , which reduces to  $8/9$ . Another way to obtain these results is to consider that the odds for  $II_2$  being a carrier versus not being a carrier are  $1/16$  to  $1/2$  (i.e., 1 to 8, which equals 1 in 9). Thus, by taking into account the fact that  $II_2$  has three healthy sons, we have been able to reduce her risk of being a carrier from 1 in 2 to 1 in 9.

By now the use of Bayes' theorem should be a little clearer. Remember that the basic approach is to draw up a table showing all of the possibilities (e.g., carrier, not a carrier), then establish the background (prior) risk for each possibility, next determine the chance (conditional possibility) that certain observed events (e.g., healthy children) would have happened if each possibility were true, then work out the combined (joint) likelihood for each possibility, and finally weigh up each of the joint probabilities to calculate the exact (posterior) probability for each of the original possibilities. Here are more examples.

### Autosomal Dominant Inheritance

For someone with an autosomal dominant disorder, the risk that each of his or her children will inherit the mutant gene equals 1 in 2. This will apply whether the affected individual inherited the disorder from a parent or developed the condition

**Table 8.1** Bayesian Calculation for  $II_2$  in Figure 8.1

Probability	$II_2$ Is a Carrier	$II_2$ Is Not a Carrier
Prior	$1/2$	$1/2$
<b>Conditional</b>		
Three healthy sons	$(1/2)^3 = 1/8$	$(1)^3 = 1$
<b>Joint</b>	$1/16$	$1/2 (= 8/16)$
Expressed as odds	1 to	8
<b>Posterior</b>	$1/9$	$8/9$

as the result of a new mutation. Therefore the provision of risks for disorders showing autosomal dominant inheritance is usually straightforward as long as there is a clear family history, the condition is characterized by being fully penetrant, and there is a reliable means of diagnosing heterozygotes. However, if penetrance is incomplete or there is a delay in the age of onset so that heterozygotes cannot always be diagnosed, the risk calculation becomes more complicated. Two examples illustrate the problems that can arise.

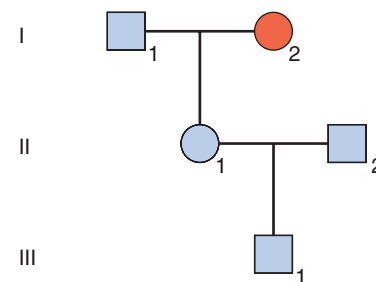
### Reduced Penetrance

A disorder is said to show **reduced penetrance** when it has clearly been demonstrated that individuals who must possess the abnormal gene, who by pedigree analysis must be obligate heterozygotes, show absolutely no manifestations of the condition. For example, if someone who was completely unaffected had both a parent and a child with the same autosomal dominant disorder, this would be an example of **non-penetrance**. Penetrance is usually quoted as a percentage (e.g., 80%) or as a proportion of 1 (e.g., 0.8). This would imply that 80% of all heterozygotes express the condition in some way.

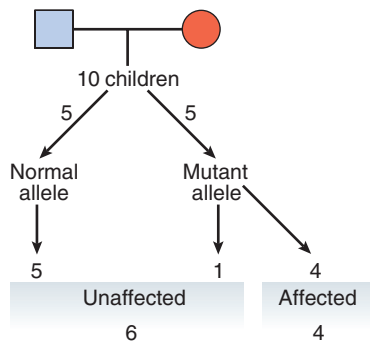
For a condition showing reduced penetrance, the risk that the child of an affected individual will be affected equals  $1/2$ —i.e., the probability that the child will inherit the mutant allele,  $\times P$ , the proportion of heterozygotes who are affected. Therefore, for a disorder such as hereditary retinoblastoma, an embryonic eye tumor (p. 182), which shows dominant inheritance in some families with a penetrance of  $P = 0.8$ , the risk that the child of an affected parent will develop a tumor equals  $1/2 \times 0.8$ , which equals 0.4. A more difficult calculation arises when a risk is sought for the future child of someone who is healthy but whose parent has, or had, an autosomal dominant disorder showing reduced penetrance (Figure 8.2).

Let us assume the penetrance,  $P$ , equals 0.8. Calculation of the risk that  $III_1$  will be affected can be approached in two ways. The first simply involves a little logic. The second uses Bayes' theorem.

1. Imagine that  $I_2$  has 10 children. On average, five children will inherit the gene, but because  $P = 0.8$ , only four will be affected (Figure 8.3). Therefore, six of the 10 children will be unaffected, one of whom has the mutant allele, with the remaining five having the normal allele.  $II_1$  is unaffected, so there is a probability of 1 in 6 that she is, in fact, a heterozygote. Consequently, the probability that  $III_1$  will both inherit the mutant gene and be affected equals  $1/6 \times 1/2 \times P$ , which equals  $1/15$  if  $P$  is 0.8.
2. Now consider  $II_1$  in Figure 8.2. The prior probability that she is a heterozygote equals  $1/2$ . Similarly, the prior



**FIGURE 8.2**  $I_2$  has an autosomal dominant disorder that shows reduced penetrance. The probability that  $III_1$  will be affected has to take into account the possibility that his mother ( $II_1$ ) is a non-penetrant heterozygote.



**FIGURE 8.3** Expected genotypes and phenotypes in 10 children born to an individual with an autosomal dominant disorder with penetrance equal to 0.8.

probability that she is not a heterozygote equals 1/2. Now a bayesian table can be constructed to determine how these prior probabilities are modified by the fact that II<sub>1</sub> is not affected (Table 8.2).

The posterior probability that II<sub>1</sub> is a heterozygote equals  $1/2(1 - P)/[1/2(1 - P) + 1/2]$ , which reduces to  $[1 - P/2 - P]$ . Therefore, the risk that III<sub>1</sub> will both inherit the mutant allele and be affected equals  $(1 - P/2 - P) \times 1/2 \times P$ , which reduces to  $[(P - P^2)/(4 - 2P)]$ . If P equals 0.8, this expression equals 1/15 or 0.067.

By substituting different values of P in the above expression, it can be shown that the maximum risk for III<sub>1</sub> being affected equals 0.086, approximately 1/12, which is obtained when P equals 0.6. This maximal risk figure can be used when counseling people at risk for late-onset autosomal disorders with reduced penetrance and who have an affected grandparent and unaffected parents.

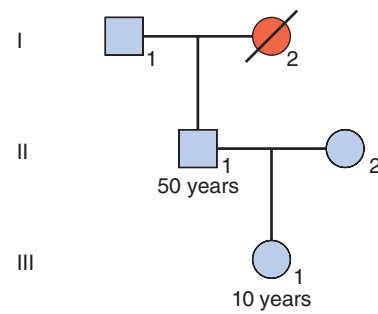
**Delayed Age of Onset**

Many autosomal dominant disorders do not present until well into adult life. Healthy members of families in which these disorders are segregating often wish to know whether they themselves will develop the condition and/or pass it on to their children. Risks for these individuals can be calculated in the following way.

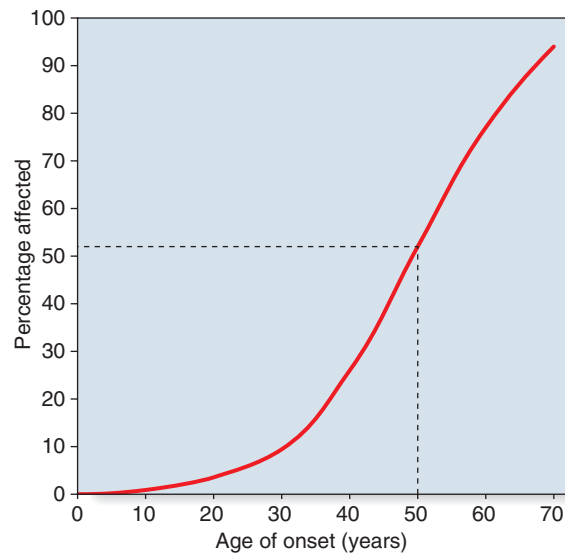
Consider someone who has died with a confirmed diagnosis of Huntington disease (Figure 8.4). This is a late-onset autosomal dominant disorder. The son of I<sub>2</sub> is entirely healthy at age 50 years and wishes to know the probability that his 10-year-old daughter, III<sub>1</sub>, will develop Huntington disease in later life. In this condition, the first signs usually appear between the ages of 30 and 60 years, and approximately 50% of all heterozygotes show signs by the age of 50 years (Figure 8.5).

To answer the question about the risk to III<sub>1</sub>, it is first necessary to calculate the risk for II<sub>1</sub> (if III<sub>1</sub> was asking about her own risk, her father might be referred to as the **dummy consultant**). The probability that II<sub>1</sub> has inherited the gene, given

Table 8.2 Bayesian Calculation for II <sub>1</sub> in Figure 8.2		
Probability	II <sub>1</sub> Is Heterozygous	II <sub>1</sub> Is Not Heterozygous
Prior	1/2	1/2
<b>Conditional</b>		
Not affected	1 - P	1
<b>Joint</b>	1/2 (1 - P)	1/2



**FIGURE 8.4** I<sub>2</sub> had an autosomal dominant disorder showing delayed age of onset. When calculating the probability that III<sub>1</sub> will develop the disorder, it is necessary to determine the probability that II<sub>1</sub> is a heterozygote who is not yet clinically affected.



**FIGURE 8.5** Graph showing age of onset in years of clinical expression in Huntington disease heterozygotes. Approximately 50% show clinical signs or symptoms by age 50 years. (Data from Newcombe RG 1981 A life table for onset of Huntington's chorea. *Ann Hum Genet* 45:375–385.)

that he shows no signs of the condition, can be determined by a simple bayesian calculation (Table 8.3).

The posterior probability that II<sub>1</sub> is heterozygous equals  $1/4/(1/4 + 1/2)$ , which equals 1/3. Therefore, the prior probability that his daughter III<sub>1</sub> will have inherited the disorder equals  $1/3 \times 1/2$ , or 1/6.

There is a temptation when doing calculations such as these to conclude that the overall risk for II<sub>1</sub> being a heterozygote simply equals  $1/2 \times 1/2$ —i.e., the prior probability that he will have inherited the mutant gene times the probability that a

**Table 8.3** Bayesian Calculation for II<sub>1</sub> in Figure 8.4

Probability	II <sub>1</sub> Is Heterozygous	II <sub>1</sub> Is Not Heterozygous
Prior	1/2	1/2
<b>Conditional</b>		
Unaffected at age 50 years	1/2	1
<b>Joint</b>	1/4	1/2

heterozygote will be unaffected at age 50 years, giving a risk of 1/4. This is correct in as much as it gives the joint probability for this possible outcome, but it does not take into account the possibility that  $II_1$  is not a heterozygote. Consider the possibility that  $I_2$  has four children. On average, two will inherit the mutant allele, one of whom will be affected by the age of 50 years. The remaining two children will not inherit the mutant allele. By the time these children have grown up and reached the age of 50 years, on average one will be affected and three will not. Therefore, on average, one-third of the healthy 50-year-old offspring of  $I_2$  will be heterozygotes. Hence the correct risk for  $II_1$  is 1/3 and not 1/4.

### Autosomal Recessive Inheritance

With an autosomal recessive condition, the **biological** parents of an affected child are both heterozygotes. Apart from undisclosed non-paternity and donor insemination, there are two possible exceptions, both of which are very rare. These arise when only one parent is a heterozygote, in which case a child can be affected if either a new mutation occurs on the gamete inherited from the other parent, or uniparental disomy occurs resulting in the child inheriting two copies of the heterozygous parent's mutant allele (p. 77). For practical purposes, it is usually assumed that both parents of an affected child are carriers.

### Carrier Risks for the Extended Family

When both parents are heterozygotes, the risk that each of their children will be affected is 1 in 4. On average three of their four children will be unaffected, of whom, on average, two will be carriers (Figure 8.6). Therefore the probability that the healthy sibling of someone with an autosomal recessive disorder will be a carrier equals 2/3. Carrier risks can be derived for other family members, starting with the assumption that both parents of an affected child are carriers (Figure 8.7).

When calculating risks in autosomal recessive inheritance the underlying principle is to establish the probability that each prospective parent is a carrier, and then multiply the product of these probabilities by 1/4, this being the risk that any child born to two carriers will be affected. Therefore, in Figure 8.7, if the sister,  $III_3$ , of the affected boy was to marry her first cousin,  $III_4$ , the probability that their first baby would be affected would equal  $2/3 \times 1/4 \times 1/4$ —i.e., the probability that

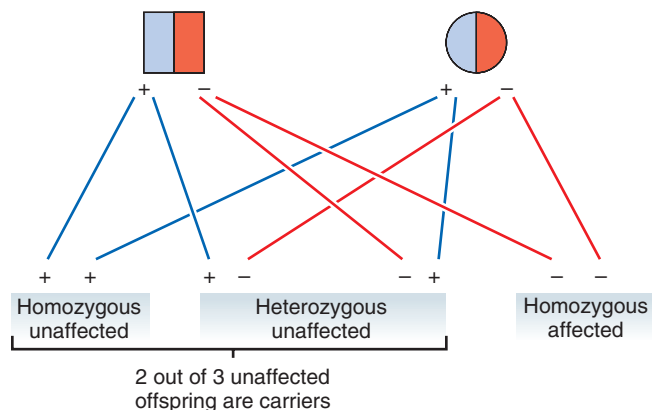


FIGURE 8.6 Possible genotypes and phenotypes in the offspring of parents who are both carriers of an autosomal recessive disorder. On average, two of three healthy offspring are carriers.

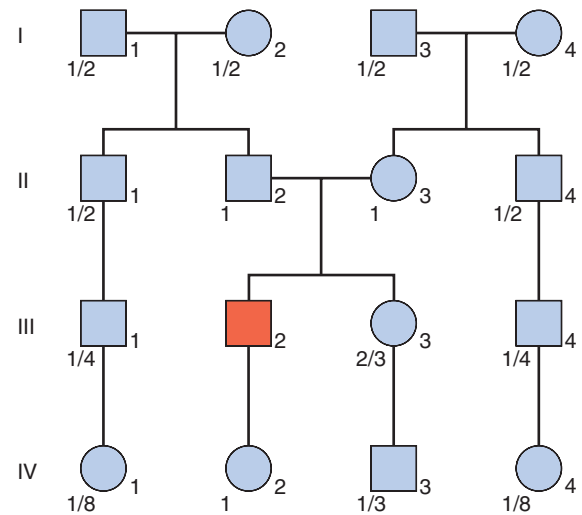


FIGURE 8.7 Autosomal recessive inheritance. The probabilities that various family members are carriers are indicated as fractions.

$III_3$  is a carrier times the probability that  $III_4$  is a carrier times the probability that a child of two carriers will be affected. This gives a total risk of 1/24.

If this same sister,  $III_3$ , was to marry a healthy unrelated individual, the probability that their first child would be affected would equal  $2/3 \times 2pq \times 1/4$ —i.e., the probability that  $III_3$  is a carrier times the carrier frequency in the general population (p. 86) times the probability that a child of two carriers will be affected. For a condition such as cystic fibrosis, with a disease incidence of approximately 1 in 2500,  $q^2 = 1/2500$  and therefore  $q = 1/50$  and thus  $2pq = 1/25$ . Therefore the final risk would be  $2/3 \times 1/25 \times 1/4$ , or 1 in 150.

### Modifying a Carrier Risk by Mutation Analysis

Newborn screening for cystic fibrosis has been introduced in the United Kingdom after pilot studies (p. 151). Around 2000 different mutations have been identified in the cystic fibrosis gene, so that carrier detection by DNA mutation analysis is not straightforward. However, a relatively simple test has been developed for the most common mutations, which enables about 90% of all carriers of western European origin to be detected. What is the probability that a healthy individual who has no family history of cystic fibrosis, and who tests negative on the common mutation screen, is a carrier?

The answer is obtained, once again, by drawing up a simple Bayesian table (Table 8.4). The prior probability that this healthy member of the general population is a carrier equals 1/25; therefore the prior probability that he or she is not a carrier equals 24/25. If this individual is a carrier, then the

Table 8.4 Bayesian Table for Cystic Fibrosis Carrier Risk if Common Mutation Screen Is Negative

Probability	Carrier	Not a Carrier
Prior	1/25	24/25
<b>Conditional</b>		
Normal result on common mutation screening	0.10	1
<b>Joint</b>	1/250	24/25

probability that the common mutation test will be normal is 0.10 as only 10% of carriers do not have a common mutation. The probability that someone who is not a carrier will have a normal common mutation test result is 1.

This gives a joint probability for being a carrier of 1/250 and for not being a carrier of 24/25. Therefore the posterior probability that this individual is a carrier equals  $1/250 / (1/250 + 24/25)$ , which equals 1/241. Thus, the normal result on common mutation testing has reduced the carrier risk from 1/25 to 1/241.

### Sex-Linked Recessive Inheritance

Among mendelian disorders this pattern of inheritance tends to generate the most complicated risk calculations. In severe sex-linked conditions, affected males are often unable to have their own children. Consequently, these conditions are usually transmitted only by healthy female carriers. The carrier of a sex-linked recessive disorder transmits the gene on average to half of her daughters, who are therefore carriers, and to half of her sons who will thus be affected. If an affected male does have children, he will transmit his Y chromosome to all of his sons, who will be unaffected, and his X chromosome to all of his daughters, who will be carriers (Figure 8.8).

An example of how the birth of unaffected sons to a possible carrier of a sex-linked disorder results in a reduction of her carrier risk has already been discussed in the introduction to Bayes' theorem (p. 94). Here we consider two further factors that can complicate risk calculation in sex-linked recessive disorders.

#### The Isolated Case

If a woman has only one affected son, then in the absence of a positive family history there are three possible ways in which this can have occurred.

1. The woman is a carrier of the mutant allele, in which case there is a risk of 1/2 that any future son will be affected.
2. The disorder in the son arose because of a new mutation that occurred during meiosis in the gamete that led to his

conception. The recurrence risk in this situation is negligible.

3. The woman is a **gonadal mosaic** (p. 76) for the mutation that occurred in an early mitotic division during her own embryonic development. The recurrence risk will be equal to the proportion of ova that carry the mutant allele (i.e., between 0% and 50%).

It may be very difficult to distinguish between these three possibilities unless reliable tests are available for carrier detection (which is increasingly the case with modern molecular analysis). If a woman is found to be a carrier, then risk calculation is straightforward. If the tests indicate that she is not a carrier, the recurrence risk is probably low, but not negligible because of the possibility of **gonadal mosaicism**.

For example, in Duchenne Muscular Dystrophy (DMD; p. 281), it has been estimated that among the mothers of isolated cases approximately two-thirds are carriers, 5% to 10% are gonadal mosaics, and in the remaining 25% to 30% the disorder has arisen as a new mutation in meiosis.

Leaving aside the complicating factor of gonadal mosaicism, risk calculation in the context of an isolated case (Figure 8.9) is possible, but may require calculation of the risk for a **dummy consultand** within the pedigree as well as taking account of the **mutation rate**, or  $\mu$ . For a fuller understanding of  $\mu$ , the student is referred to one of the more detailed texts listed at the end of the chapter.

#### Incorporating Carrier Test Results

Where mutation analysis is not available biochemical tests may help in detecting carriers of sex-linked recessive disorders. Unfortunately, there is often overlap in the values obtained for controls and women known to be obligate carriers. Although an abnormal result in a potential carrier would suggest that she is likely to be a carrier, a normal test result does not exclude a woman from being a carrier. Consider the example of DMD.

In DMD the serum creatine kinase level is raised in approximately two out of three obligate carriers (see Figure 11.2; p. 145). Therefore, if a possible carrier such as II<sub>2</sub> in Figure 8.1

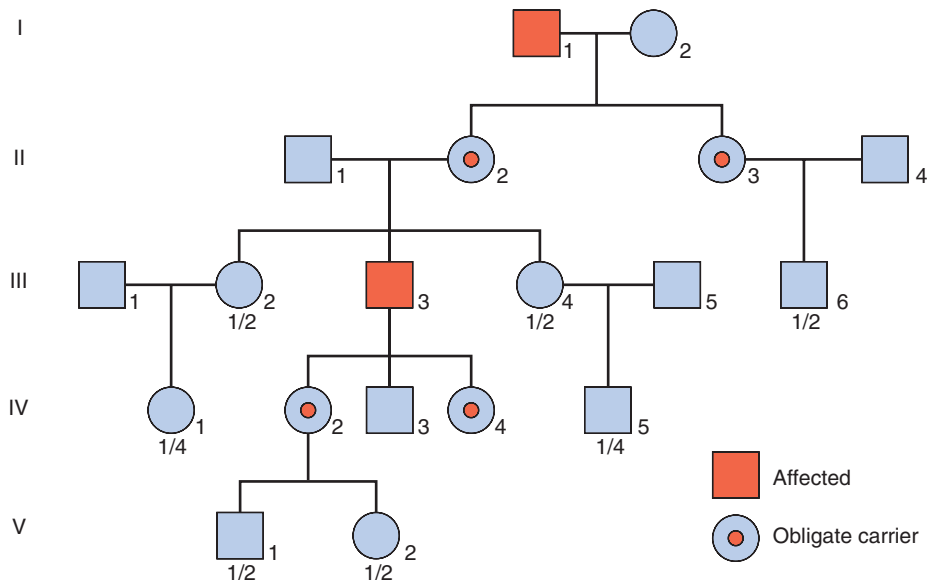
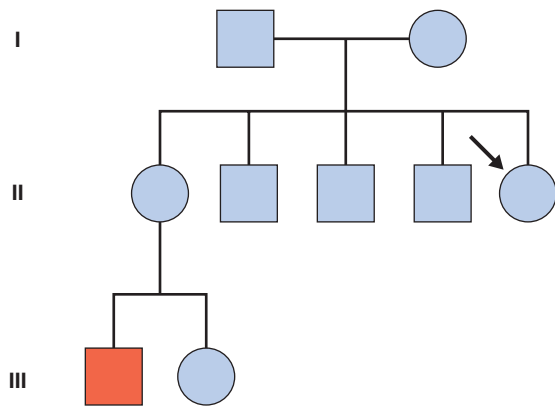


FIGURE 8.8 Probabilities of male relatives being affected and female relatives being carriers of an X-linked recessive disorder. All the daughters of an affected male are obligate carriers.



**FIGURE 8.9** In this pedigree III<sub>1</sub> is affected by Duchenne muscular dystrophy and is an isolated case (i.e., there is no history of the condition in the wider family). The consultand, II<sub>5</sub> (arrow), wishes to know whether she is at risk of having affected sons. To calculate her risk, the risk that her mother, I<sub>2</sub>, is a carrier is first calculated; this requires consideration of the mutation rate,  $\mu$ . I<sub>2</sub> is the *dummy consultand* in this scenario.

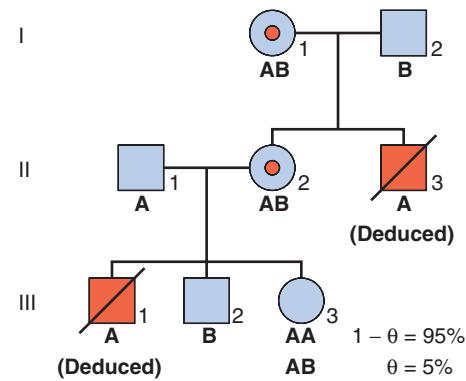
is found to have a normal level of creatine kinase, this would provide further support for her not being a carrier. The test result therefore provides a conditional probability, which is included in a new bayesian calculation (Table 8.5).

The posterior probability that II<sub>2</sub> is a carrier equals  $1/48 / (1/48 + 1/2)$ , or  $1/25$ . Consequently, by first taking into account this woman's three healthy sons, and second her normal creatine kinase test result, it has been possible to reduce her carrier risk from 1 in 2 to 1 in 9 and then to 1 in 25.

### The Use of Linked Markers

Today, for most single-gene disorders sequence analysis is possible if not always routine. Linked DNA markers are therefore rarely used but still sometimes have a role in clarifying the genetic status of an individual in a pedigree, for example where the affected individual died and no DNA was stored. There must be certainty that the disease in question is caused by mutations at just one gene locus and is not **genetically** heterogeneous.

To illustrate, consider the sister of a boy affected with DMD, now deceased, whose mother is an obligate carrier as she herself had an affected brother (Figure 8.10). A DNA marker with alleles A and B is available and is known to be closely linked to the DMD disease locus with a recombination fraction ( $\theta$ ) equal to 0.05. The disease allele must, by deduction, be linked with the A marker allele in II<sub>2</sub>, because II<sub>2</sub> must have inherited the B allele from her normal father, which she has passed to her unaffected son III<sub>2</sub>. If II<sub>1</sub> also has the A allele (not in this case linked to DMD because he is not a relative



**FIGURE 8.10** Pedigree showing a DMD family where the affected individuals are deceased and no DNA is available. **A** and **B** represent alleles closely linked to the dystrophin gene.

and is unaffected), the combination of alleles in III<sub>3</sub> is either AA or AB. If AA, III<sub>3</sub> has inherited the high-risk allele from her mother but, if AB she has inherited the low-risk B allele, the final probability is a function of the chance of a crossover (the recombination fraction,  $\theta$ ) having occurred between the actual mutation and marker locus at meiosis in the ovum from which she was conceived. Therefore, with markers AA the carrier risk is 0.95 or 95%, and with AB the carrier risk for III<sub>3</sub> 0.05 or 5%.

It follows that the smaller the value of  $\theta$ , the smaller the likelihood of a predictive error. If DNA markers 'bridge' or 'flank' the disease locus, this greatly reduces the risk of a predictive error as only a *double* crossover will go undetected, which is extremely unlikely.

### Bayes' Theorem and Prenatal Screening

To further illustrate the potential of Bayes' theorem in genetic risk calculation counseling, an example from prenatal screening follows. A woman age 20 years presents at 13 weeks' gestation with a fetus that has been shown on ultrasound to have significant nuchal translucency (NT) (see Figure 20.6). NT may be present in about 75% of fetuses with Down syndrome (p. 303). In contrast, the incidence in babies not affected with Down syndrome is approximately 5%. Therefore, NT is 15 times more common in Down syndrome than in unaffected fetuses.

Question: Does this mean that the odds are 15 to 1 that this unborn baby has Down syndrome? No! This risk, or more precisely **odds ratio**, would be correct only if the prior probabilities that the baby would be affected or unaffected were equal. In reality the prior probability that the baby will be unaffected is much greater than the prior probability that it will have Down syndrome.

Actual values for these prior probabilities can be obtained by reference to a table showing maternal age-specific risks for Down syndrome (see Table 17.4; p. 237). For a woman age 20, the incidence of Down syndrome is approximately 1 in 1500; hence, the prior probability that the baby will be unaffected equals 1499/1500. If these prior probability values are used in a bayesian calculation, it can be shown that the posterior probability risk that the unborn baby will have Down syndrome is approximately 1 in 100 (Table 8.6), a world apart from the conditional odds of 15 to 1 in favor of the baby being affected.

In practice, the demonstration of NT on ultrasonography in a fetus would usually prompt an offer of definitive

**Table 8.5** Bayesian Calculation for II<sub>2</sub> in Figure 8.1

Probability	II <sub>2</sub> Is a Carrier	II <sub>2</sub> Is Not a Carrier
Prior	1/2	1/2
<b>Conditional</b>		
Three healthy sons	1/8	1
Normal creatine kinase	1/3	1
<b>Joint</b>	1/48	1/2

**Table 8.6** Bayesian Calculation to Show the Posterior Probability that a Fetus With Nuchal Translucency Conceived by a 20-Year-Old Mother Will Have Down Syndrome

Probability	Fetus Unaffected	Fetus Affected
Prior	1499/1500	1/1500
<b>Conditional</b>		
Nuchal translucency	1	15
<b>Joint</b>	1499/1500 = 1	1/100
<b>Expressed as odds</b>	100	to 1
<b>Posterior</b>	100/101	1/101

chromosome analysis by placental biopsy, amniocentesis, or fetal blood sampling (see Chapter 20). This example emphasizes that an observed conditional probability ratio should always be combined with prior probability information to calculate the actual risk.

### Empiric Risks

Up to this point, risks have been calculated for single-gene disorders using knowledge of basic mendelian genetics and applied probability theory. In many counseling situations it is not possible to arrive at an accurate risk figure in this way, either because the disorder in question does not show single-gene inheritance or because the clinical diagnosis with which the family has been referred shows causal heterogeneity (see below). In these situations, it is usually necessary to resort to the use of observed or **empiric risks**. These are based on observations derived from family and population studies rather than theoretical calculations.

### Multifactorial Disorders

One of the basic principles of multifactorial inheritance is that the risk of recurrence in first-degree relatives, siblings and offspring, equals the square root of the incidence of the disease in the general population (p. 134)—i.e.,  $P^{1/2}$ , where P equals the general population incidence. For example, if the general population incidence equals 1/1000, then the theoretical risk to a first-degree relative equals the square root of 1/1000,

which approximates to 1 in 32 or 3%. The theoretical risks for second- and third-degree relatives can be shown to approximate to  $P^{3/4}$  and  $P^{7/8}$ , respectively. Therefore, if there is strong support for multifactorial inheritance, it is reasonable to use these theoretical risks when counseling close family relatives.

However, when using this approach it is important to remember that the confirmation of multifactorial inheritance will often have been based on the study of observed recurrence risks. Consequently, it is generally more appropriate to refer back to the original family studies and counsel on the basis of the derived risks (Table 8.7).

Ideally, reference should be made to local studies as recurrence risks may differ in specific communities, ethnic groups, and geographical locations. For example, in the UK, the recurrence risk for neural tube defects in siblings used to be quoted as 4% (before the promotion of periconceptional maternal folate intake). This, essentially, was an average risk. The actual risk varied from 2% to 3% in southeast England up to 8% in Northern Ireland, and also showed an inverse relationship with the family's socioeconomic status, being greatest for mothers in poorest circumstances.

Unfortunately, empiric risks are rarely available for families in which there are several affected family members, or for disorders with variable severity or different sex incidences. For example, in a family where several members have been affected by cleft lip/palate, the empiric risks based on population data may not apply—the condition may appear to be segregating as an autosomal dominant trait with a high penetrance. In the absence of a syndrome diagnosis being made and genetic testing being possible, the clinical geneticist has to make the best judgement about recurrence risk.

### Conditions Showing Causal Heterogeneity

Many referrals to genetic clinics relate to a clinical phenotype rather than to a precise underlying diagnosis (Table 8.8). In these situations, great care must be taken to ensure that all appropriate diagnostic investigations have been undertaken before resorting to the use of empiric risk data.

It is worth emphasizing that the use of empiric risks for conditions such as sensorineural hearing loss in childhood is at best a compromise, as the figure quoted to an individual family

**Table 8.7** Empiric Recurrence Risks for Common Multifactorial Disorders

Disorder	Incidence (Per 1000)	Sex Ratio (M : F)	Unaffected Parents Having a Second Affected Child (%)	Affected Parents Having an Affected Child (%)
Cleft lip ± cleft palate	1–2	3 : 2	4	4
Clubfoot (talipes)	1–2	2 : 1	3	3
Congenital heart defect	8	1 : 1	1–4	2 (father affected) 6 (mother affected)
Congenital dislocation of the hip	1	1 : 6	6	12
Hypospadias (in males)	2	—	10	10
Manic depression	4	2 : 3	10–15	10–15
<b>Neural Tube Defect</b>				
Anencephaly	1.5	1 : 2	4–5	—
Spina bifida	2.5	2 : 3	4–5	4
<b>Pyloric Stenosis</b>				
Male index	2.5	—	2	4
Female index	0.5	—	10	17
Schizophrenia	10	1 : 1	10	14

**Table 8.8** Empiric Recurrence Risks for Conditions Showing Causal Heterogeneity

Disorder	Incidence (Per 1000)	Sex Ratio (M : F)	Unaffected Parents Having a Second Affected Child (%)	Affected Parents Having an Affected Child (%)
Autism	1–2	4 : 1	2–3	—
Epilepsy (idiopathic)	5	1 : 1	5	5
Hydrocephalus	0.5	1 : 1	3	—
Learning disability (idiopathic)	3	1 : 1	3–5	10
Profound childhood sensorineural hearing loss	1	1 : 1	10–15	5–10

will rarely be the correct one for their particular diagnosis. Severe sensorineural hearing loss in a young child is usually caused either by single-gene inheritance, most commonly autosomal recessive, but occasionally autosomal dominant or sex-linked recessive, or by an environmental condition such as rubella embryopathy. Therefore, for most families the correct risk of recurrence will be either 25% or 0%. In practice, it is often not possible to establish the precise cause, so that the only option available is to offer the family an empiric or 'average' risk.

### FURTHER READING

Bayes, T., 1958. An essay towards solving a problem in the doctrine of chances. *Biometrika* 45, 296–315.

*A reproduction of the Reverend Bayes' original essay on probability theory that was first published, posthumously, in 1763.*

Emery, A.E.H., 1986. *Methodology in medical genetics*, 2nd ed. Churchill Livingstone, Edinburgh, UK.

*An introduction to statistical methods of analysis in human and medical genetics.*

Murphy, E.A., Chase, G.A., 1975. *Principles of genetic counseling*. Year Book Medical, Chicago.

*A very thorough explanation of the use of Bayes' theorem in genetic counseling.*

Young, I.D., 1999. *Introduction to risk calculation in genetic counseling*, 2nd ed. Oxford University Press, Oxford, UK.

*A short introductory guide to all aspects of risk calculation in genetic counseling. Highly recommended.*

### ELEMENTS

- 1 Risk calculation in genetic counseling requires a knowledge and understanding of basic probability theory. Bayes' theorem enables initial background 'prior' risks to be modified by 'conditional' information to give an overall probability or risk for a particular event such as carrier status.
- 2 For disorders showing autosomal dominant inheritance it is often necessary to consider factors such as reduced penetrance and age of onset. For disorders showing autosomal recessive inheritance, risks to offspring are determined by calculating the probability that each parent is a carrier and then multiplying the product of these probabilities by 1/4.
- 3 In sex-linked recessive inheritance, a particular problem arises when only one male in a family is affected. The results of biochemical carrier tests that show overlap between carriers and non-carriers can be incorporated in a bayesian calculation.
- 4 Although relatively rare today, polymorphic DNA markers linked to a mendelian disease locus can be used for carrier detection, preclinical diagnosis, and prenatal diagnosis.
- 5 Empiric (observed) risks are available for multifactorial disorders and for etiologically heterogeneous conditions such as non-syndromal sensorineural hearing loss.

# Chapter 9

## Developmental Genetics

*The history of man for the nine months preceding his birth would, probably, be far more interesting and contain events of greater moment than all the three score and ten years that follow it.*

SAMUEL TAYLOR COLERIDGE

At fertilization the nucleus from a spermatozoon penetrates the cell membrane of an oocyte to form a zygote. This single cell divides to become two, then four, and when the number has doubled some 50 times the resulting organism comprises more than 200 distinct cell types and a total cell number of approximately 10,000 trillion. This is a fully formed human being with complex biochemistry and physiology, capable of exploring the cosmos and identifying subatomic particles. Not surprisingly, biologists and geneticists are intrigued by the mechanisms of early development and, whereas many mysteries remain, the rate of progress in understanding key events and signaling pathways is rapid.

A fetus is recognizably human approximately after 12 weeks of pregnancy—the first trimester. Normal development requires an optimum maternal environment but genetic integrity is fundamental; this has given rise to the field of developmental genetics. Most of what we know about the molecular processes inevitably comes from the study of animal models, with great emphasis on the mouse, whose genome closely resembles our own.

Prenatal life can be divided into three main stages: **pre-embryonic**, **embryonic**, and **fetal** (Table 9.1). During the pre-embryonic stage, a small collection of cells becomes distinguishable, first as a double-layered or **bilaminar disc**, and then as a triple-layered or **trilaminar disc** (Figure 9.1), which is destined to develop into the human infant. During the embryonic stage, craniocaudal, dorsoventral, and proximodistal axes are established, as cellular aggregation and differentiation lead to tissue and organ formation. The final fetal stage is characterized by rapid growth and development as the embryo, now a fetus, matures into a viable human infant.

On average, this extraordinary process takes approximately 38 weeks. By convention pregnancy is usually dated from the first day of the last menstrual period, which usually precedes conception by around 2 weeks, so that the normal period of gestation is often stated (incorrectly) as 40 weeks.

### Fertilization and Gastrulation

Fertilization, the process by which the male and female gametes fuse, occurs in the fallopian tube. Of the 100 to 200 million spermatozoa deposited in the female genital tract, only a few hundred reach the site of fertilization. Of these, usually

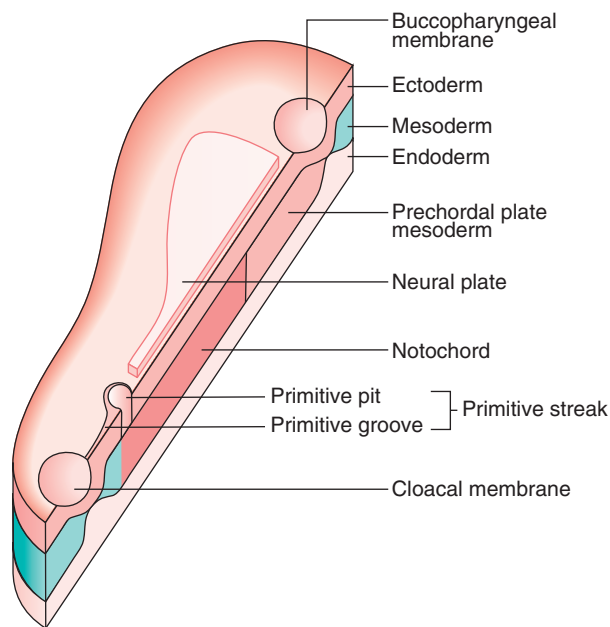
only a single spermatozoon succeeds in penetrating first the corona radiata, then the zona pellucida, and finally the oocyte cell membrane, whereupon the oocyte completes its second meiotic division (p. 32, and see Figure 3.15, p. 34). After the sperm has penetrated the oocyte and the meiotic process has been completed, the two nuclei, known as pronuclei, fuse, thereby restoring the diploid number of 46 chromosomes. This is a potentially chaotic molecular encounter with a high chance of failure, as we know from observations of the early human embryo from *in vitro* fertilization programs. It may be likened, somewhat flippantly, to ‘speed dating’, whereby couples test whether they might be compatible on the basis of only a few minutes’ conversation.

Germ cell and very early embryonic development are two periods characterized by widespread changes in DNA

**Table 9.1** Main Events in the Development of a Human Infant

Stage	Time From Conception	Length of Embryo/Fetus
<b>Pre-Embryonic</b>		
First cell division	30 h	
Zygote reaches uterine cavity	4 d	
Implantation	5–6 d	
Formation of bilaminar disc	12 d	0.2 mm
Lyonization in female	16 d	
Formation of trilaminar disc and primitive streak	19 d	1 mm
<b>Embryonic Stage</b>		
Organogenesis	4–8 wk	
Brain and spinal cord are forming, and first signs of heart and limb buds	4 wk	4 mm
Brain, eyes, heart, and limbs developing rapidly, and bowel and lungs beginning to develop	6 wk	17 mm
Digits have appeared. Ears, kidneys, liver, and muscle are developing	8 wk	4 cm
Palate closes and joints form	10 wk	6 cm
Sexual differentiation almost complete	12 wk	9 cm
<b>Fetal Stage</b>		
Fetal movements felt	16–18 wk	20 cm
Eyelids open. Fetus is now viable with specialized care	24–26 wk	35 cm
Rapid weight gain due to growth and accumulation of fat as lungs mature	28–38 wk	40–50 cm





**FIGURE 9.1** A schematic trilaminar disc, sectioned along the rostrocaudal axis. Cells from the future ectoderm (*top layer*) migrate through the primitive streak to form the endoderm (*bottom layer*) and mesoderm (*blue*). Formation of the neural plate in the overlying ectoderm, destined to be the central nervous system, involves Sonic hedgehog signaling (p. 107) from the notochord and prechordal plate mesoderm. (Redrawn with permission from Larsen WJ 1998 *Essentials of human embryology*. New York: Churchill Livingstone.)

methylation patterns—epigenetic reprogramming (see p. 121). Primordial germ cells are globally *demethylated* as they mature and are subsequently methylated *de novo* during gametogenesis, the time when most DNA methylation **imprints** are established. After fertilization a second wave of change occurs. The oocyte rapidly removes the methyl imprints from the sperm's DNA, which has the effect of resetting the developmental stopwatch to zero. By contrast, the *maternal* genome is more passively *demethylated*, as the imprinting is more resistant to the process. A third wave of methylation, *de novo*, establishes the somatic cell pattern of DNA methylation after implantation. These alternating methylation states help to control which genes are active, or expressed, at a time when two genomes, initially alien to each other, collide.

The fertilized ovum or zygote undergoes a series of mitotic divisions to consist of two cells by 30 hours, four cells by 40 hours, and 12 to 16 cells by 3 days, when it is known as a **morula**. A key concept in development at all stages is the emergence of **polarity** within groups of cells—part of the process of differentiation that generates multiple cell types with unique identities. Although precise mechanisms remain elusive, observations suggest that this begins at the very outset; in the fertilized egg of the mouse, the point of entry of the sperm determines the plane through which the first cell cleavage division occurs. This seminal event is the first step in the development of the so-called dorso-ventral, or primary body, axis in the embryo.

Further cell division leads to formation of a **blastocyst**, which consists of an inner cell mass or **embryoblast**, destined to form the embryo, and an outer cell mass or **trophoblast**, which gives rise to the placenta. The process of converting the inner

cell mass into first a bilaminar, and then a trilaminar, disc (see Figure 9.1) is known as **gastrulation**, and takes place between the beginning of the second and the end of the third weeks.

Between 4 and 8 weeks the body form is established, beginning with the formation of the primitive streak at the caudal end of the embryo. The germinal layers of the trilaminar disc give rise to **ectodermal**, **mesodermal**, and **endodermal** structures (Box 9.1). The neural tube is formed and neural crest cells migrate to form sensory ganglia, the sympathetic nervous system, pigment cells, and both bone and cartilage in parts of the face and branchial arches.

Disorders involving cells of neural crest origin, such as neurofibromatosis (p. 279), are sometimes referred to as **neurocristopathies**. This period between 4 and 8 weeks is described as the period of organogenesis, because during this interval all of the major organs are formed as regional specialization proceeds in a craniocaudal direction down the axis of the embryo.

## Developmental Gene Families

Information about the genetic factors that initiate, maintain, and direct embryogenesis is incomplete. However, extensive genetic studies of the fruit fly, *Drosophila melanogaster*, and vertebrates such as mouse, chick, and zebra-fish have identified several genes and gene families that play important roles in early developmental processes. It has also been possible through painstaking gene expression studies to identify several key developmental pathways, or cascades, to which more detail and complexity is continually being added. The gene families identified in vertebrates usually show strong sequence homology with developmental regulatory genes in *Drosophila*. Studies in humans have revealed that mutations in various members of these gene families can result in either isolated malformations or multiple congenital anomaly syndromes (see Table 16.5, p. 221). Many developmental genes produce proteins called **transcription factors** (p. 17), which control RNA transcription from the DNA template by binding to specific regulatory DNA sequences to form complexes that initiate transcription by RNA polymerase.

There are a number of different regulatory elements and mechanisms for developmental genes besides transcription factors, namely promoters, enhancers and repressors. It is

### Box 9.1 Organ and Tissue Origins

#### Ectodermal

- Central nervous system
- Peripheral nervous system
- Epidermis, including hair and nails
- Subcutaneous glands
- Dental enamel

#### Mesodermal

- Connective tissue
- Cartilage and bone
- Smooth and striated muscle
- Cardiovascular system
- Urogenital system

#### Endodermal

- Thymus and thyroid
- Gastrointestinal system
- Liver and pancreas

becoming clear that the relationships between these elements and their target genes in the molecular space of the nucleus may be crucial to gene expression and easily disrupted by a small intervening deletion, duplication, or inversion in the region. This helps to explain why the search for gene mutations in families with some monogenic disorders is sometimes fruitless, which is well illustrated by the molecular complexities that explain ectrodactyly, or split-hand-foot malformation (SHFM). The locus for SHFM type 1 is chromosome 7q21.3 and several cases were reported in association with a reciprocal translocation or chromosome rearrangement at this locus. It is now apparent that the key gene is *DLX5* but its enhancer must be intact, as well as the spatial relationship with the enhancer. Curiously, the enhancer in this case is found within the terminal exons of an upstream gene called *DYNCH11* (Figure 9.2), which has its own role in neuronal development. It is frequently the case that SHFM shows reduced or non-penetrance, which is not easily explained.

Besides these regulatory elements switching genes on and off by activating or repressing gene expression, in normal development this occurs as a highly coordinated and complex series of sequential cascades and feedback loops involving the regulation of fundamental embryological processes such as **induction** (the process in which extracellular signals give rise to a change from one cell fate to another in a particular group of cells), **segmentation**, **migration**, **differentiation**, and **programmed cell death** (known as **apoptosis**). It is believed that these processes are mediated by growth factors, cell receptors, and chemicals known as **morphogens**. Across species the signaling molecules involved are very similar. The protein signals identified over and over again tend to be members of the *transforming growth factor- $\beta$*  (*TGF- $\beta$* ) family, the *wingless* (*Wnt*) family, and the *hedgehog* (*HH*) family (see the following

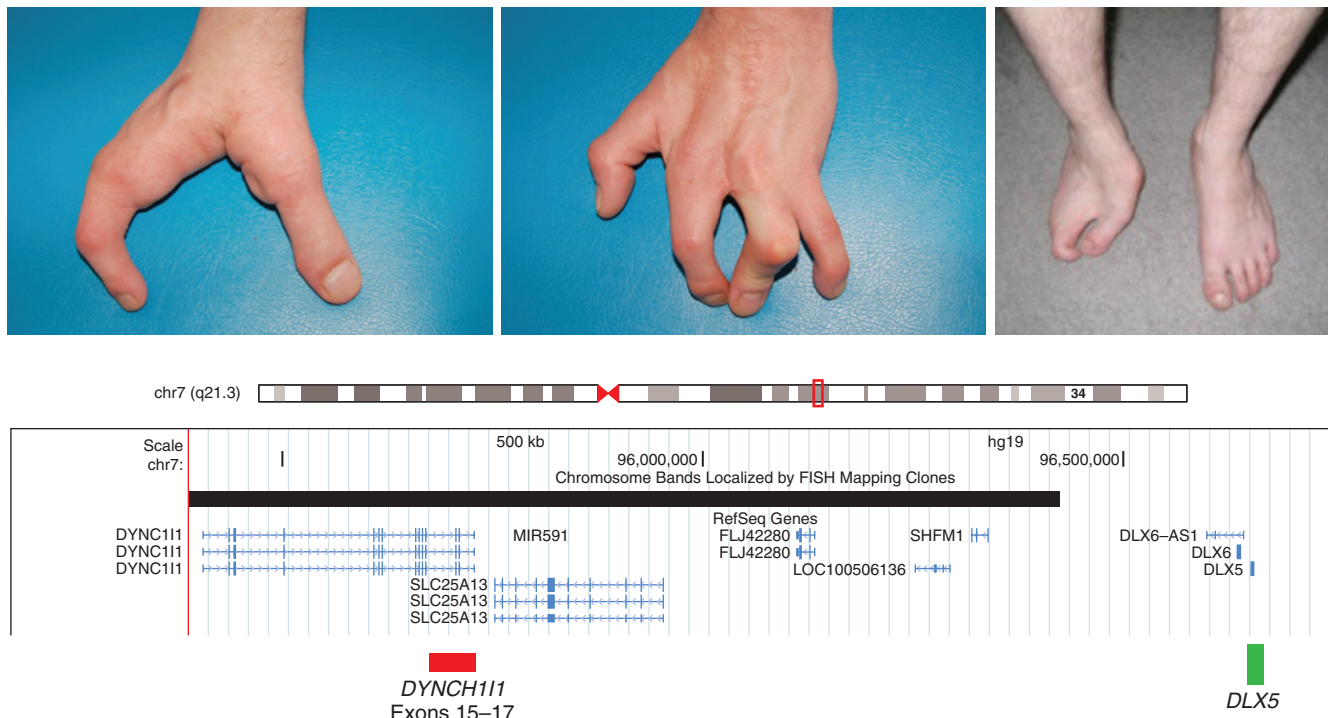
section). In addition, it is clear within any given organism that the same molecular pathways are reused in different developmental domains. In addition, it has become clear that these pathways are closely interlinked with each other, with plenty of ‘cross-talk’.

### Early Patterning

The emergence of the mesoderm heralds the transition from the stage of **bilaminar** to **trilaminar** disc, or **gastrulation**. Induction of the mesoderm—the initiation, maintenance, and subsequent patterning of this layer—involves several key families of signaling factors. The *Nodal* family is involved in initiation, fibroblast growth factors (FGFs) and WNTs are involved in maintenance, and BMPs (bone morphogenetic proteins) are involved in patterning the mesoderm. Signaling pathways are activated when a key ligand binds specific membrane-bound protein receptors. This usually leads to the phosphorylation of a cytoplasmic factor, and this in turn leads to binding with other factor(s). These factors translocate to the nucleus where transcriptional activation of specific targets occurs.

In the case of the Nodal and BMP pathways, ligand binding of a specific heterotetramer membrane-bound protein initiates the signaling, which is common to all members of the TGF- $\beta$  family, the cytoplasmic mediators being SMAD factors (see the following section). The embryo appears to have gradients of Nodal activity along the dorsal-ventral axis, although the significance and role of these gradients in mesoderm induction are uncertain.

The WNT pathway has two main branches: one that is  $\beta$ -catenin-dependent (canonical) and the other independent of  $\beta$ -catenin. In the canonical pathway, Wnt ligand binds to a Frizzled/LRP (low density lipoprotein receptor-related protein) heterodimer membrane-bound protein complex and the



**FIGURE 9.2** Split-hand-foot malformation (SHFM), *aka* ectrodactyly, and chromosome 7q21.3. In this individual with SHFM (and other family members) a deletion of approximately 100 kb has occurred, removing exons 15–17 of the *DYNCH11* gene which incorporates an enhancer of the downstream *DLX5* gene. Any disruption of the relationship between *DLX5* and its enhancer causes SHFM.

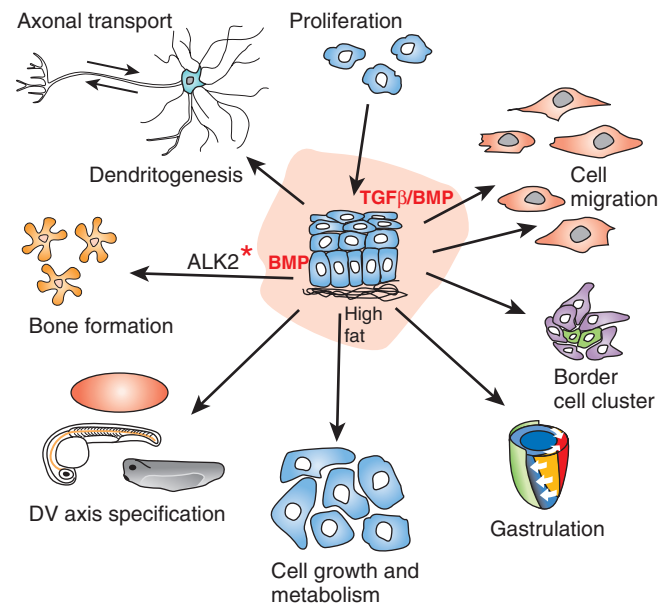
downstream intracellular signaling involves a G protein. The effect of this is to disrupt a large cytoplasmic protein complex that includes Axin, the adenomatous polyposis coli (APC; see p. 189) protein, and the glycogen synthase kinase-3 $\beta$  (GSK-3 $\beta$ ) protein. This prevents the phosphorylation of  $\beta$ -catenin, but when  $\beta$ -catenin is not degraded, it accumulates and translocates to the nucleus where it activates the transcription of dorsal-specific regulatory genes. Binding of the ligand to the Fgf receptor results in dimerization of the receptor and transphosphorylation of the receptor's cytoplasmic domain, with activation of Ras and other kinases, one of which enters the nucleus and activates target transcription factors. Mutated *WNT10A* in man results in a form of ectodermal dysplasia (odontonycho-dermal dysplasia) and *WNT4* is one of the genes implicated in the rare Mayer-Rokitansky-Kuster syndrome, featuring Müllerian (female genital) tract malformations.

### The TGF- $\beta$ Superfamily in Development and Disease

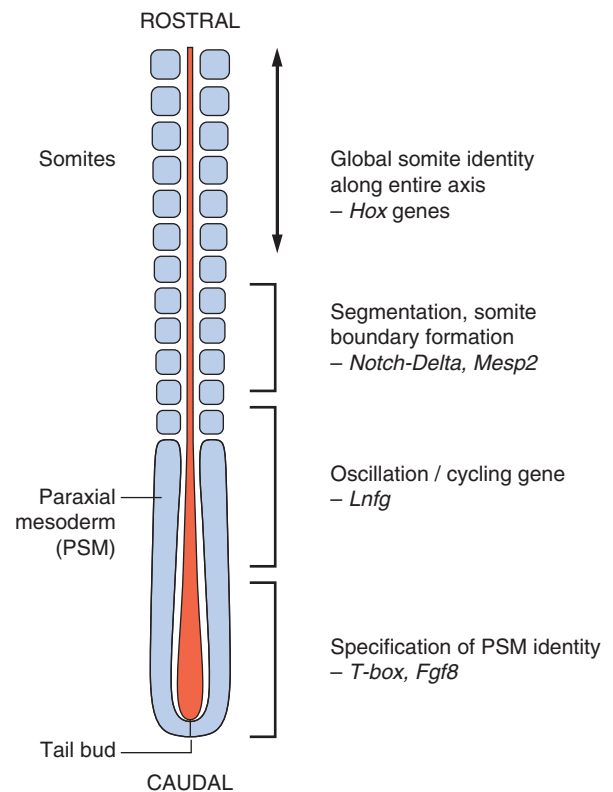
Thus far it recognized that there are more than 30 members of this **cytokine** family. Cytokines are a category of signaling molecules—polypeptide regulators—that enable cells to communicate. They differ from hormones in that they are not produced by discrete glands. These extracellular signaling polypeptides are transduced through a cascade to regulate gene expression within the cell nucleus. This is achieved through binding with cell surface receptors that, in a series of reactions, induces phosphorylation and activation of specific receptor kinases. This leads to the translocation of complexes into the nucleus, which executes transcriptional activation or repression of responsive target genes. The TGF- $\beta$  family can be divided into two groups: (1) the BMPs and (2) the TGF- $\beta$ s, activins, nodal, and myostatin, acting through various SMAD proteins. Ultimately, this superfamily is actively involved in a very broad range of cellular and developmental processes (Figure 9.3). This includes regulation of the cell cycle, cell migration, cell size, gastrulation and axis specification, and metabolic processes. In relation to health and disease, there are consequences for immunity, cancer, heart disease, diabetes, and Marfan and Loey's-Dietz syndromes (pp. 291, 293). Hyperactive signaling (overexpression) of *BMP4* has been found in the rare bony condition fibrodysplasia ossificans progressiva, where disabling heterotopic bone deposition occurs, which is due to mutated *ACVR1*, encoding a BMP type 1 receptor. A mutated BMP receptor 2 has been shown to be a cause of familial primary pulmonary hypertension (p. 288). BMP signaling is also involved in both dendritogenesis and axonal transport.

### Somatogenesis, Notch Signaling, and the Axial Skeleton

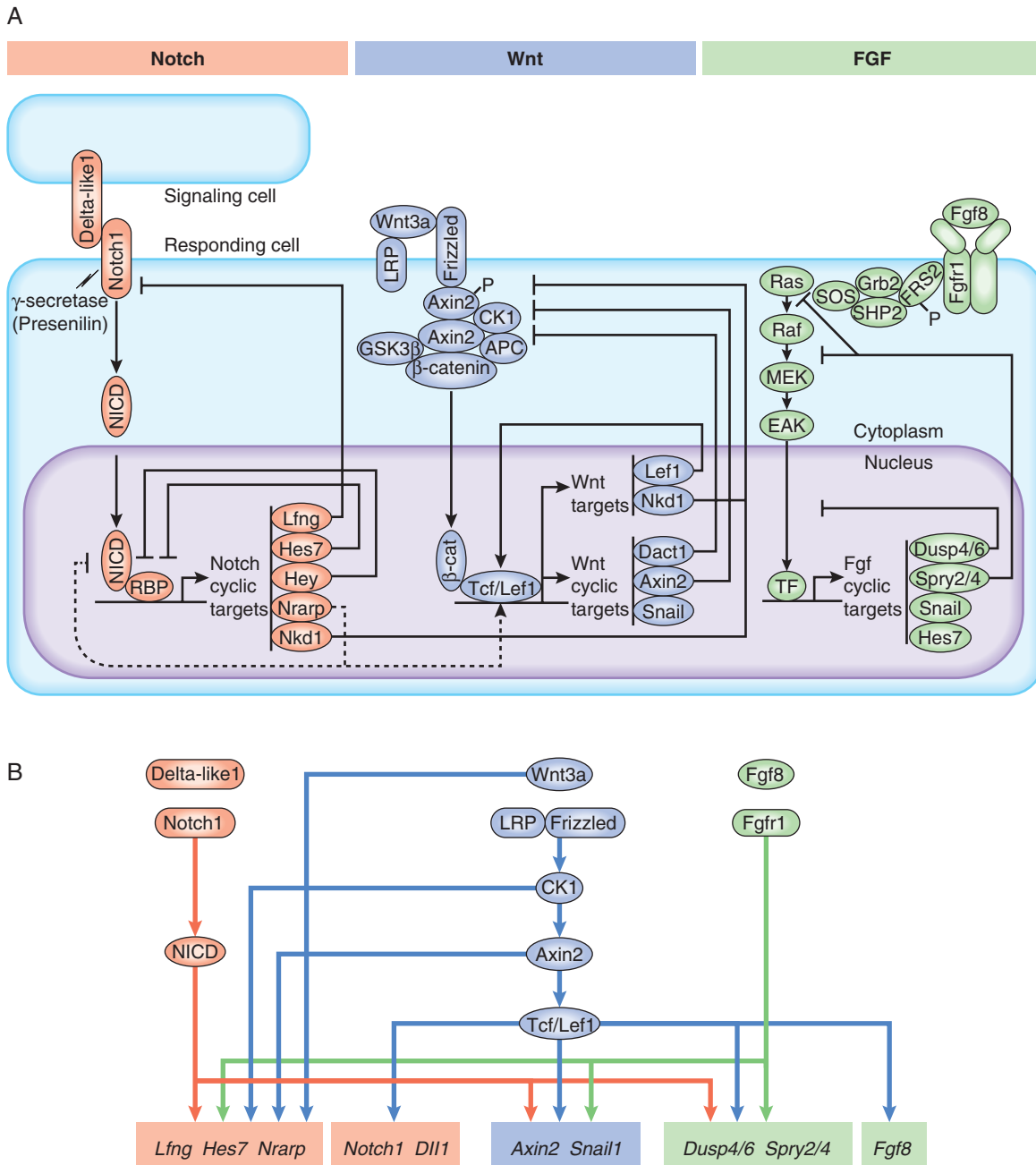
The vertebrate axis is closely linked to the development of the primary body axis during gastrulation, and during this process the presomitic mesoderm (PSM), where somites arise, is laid down in higher vertebrates. Wnt and FGF signals play vital roles in the specification of the PSM. The somites form as blocks of tissue from the PSM in a rostro-caudal direction (Figure 9.4), each being laid down with a precise periodicity that, in the 1970s, gave rise to the concept of the 'clock and wavefront' model. Since then, molecular techniques have given substance to this concept, and the key pathway here is **notch-delta signaling** and the 'oscillation clock'—a precise, temporally defined wave of **cycling gene** expression (*c-hairy* in the chick,



**FIGURE 9.3** A summary of biological responses to TGF family signaling. The range of processes that come under the influence of this superfamily is very broad. (Modified from Wharton K, Derynck R 2009 TGF $\beta$  family signaling: novel insights in development and disease. *Development* 136:3693.)



**FIGURE 9.4** Somatogenesis and Notch-Delta pathway. *T-box* genes have a role in PSM specification, whereas the segmentation clock depends on oscillation, or cycling, genes that are important in somite boundary formation where genes of the *Notch-Delta* pathway establish rostro-caudal polarity. *Hox* genes have a global function in establishing somite identity along the entire rostro-caudal axis. (Adapted from Tickle C 2003 *Patterning in vertebrate development*. Oxford: Oxford University Press.)



**FIGURE 9.5** The Notch, Wnt, and FGF signaling pathways, and their interactions. This diagram highlights the basic but complex circuitry of the three distinct ‘oscillator’ developmental pathways in the mouse presomitic mesoderm (PSM). **(A)** The Notch and Fgf-regulated genes oscillate asynchronously to those of the Wnt pathway, and many are involved in negative feedback loops. Mutations in the human orthologs of some of these genes give rise to distinct malformations or syndromes. The hashed line represents interactions in the tissues outside the PSM; and **(B)** this shows the interactions between the three pathways that have been demonstrated in the mouse PSM through the study of mouse mutants, relying on analysis of mRNA expression. (Redrawn with permission from Gibb S, Maroto M, Dale JK 2010 *The segmentation clock mechanism moves up a notch. Trends Cell Biol* 20:593–600 *An overview of Notch signaling.*)

*lunatic fringe* and *hes* genes in the mouse) that sweeps from the tail-bud region in a rostral direction and has a key role in the process leading to the defining of somite boundaries. It has become clear that the integrity of the segmentation oscillation clock is dependent on complex interactions and cross-talk between the Notch, Wnt, and FGF signaling pathways (see [Figure 9.5](#)).

Not all of the components of Notch signaling are fully understood, but the *notch receptor* and its ligands, *delta-like-1*,

and *delta-like-3*, together with *presenilin-1* and *mesoderm posterior-2*, work in concert to establish rostro-caudal polarity within the PSM such that somite blocks are formed. Human phenotypes from mutated genes in this pathway are now well known and include presenile dementia (*presenilin-1*), which is dominantly inherited, and spondylocostal dysostosis (*delta-like-3*, *mesoderm posterior-2*, *lunatic fringe*, and *hairy enhancer of split-7*), which is recessively inherited ([Figure 9.6](#)). *T-Box6* is implicated in some cases of dominantly inherited as well as



**FIGURE 9.6** Disrupted development of the vertebrae in a patient with spondylocostal dysostosis type 1 resulting from mutations in the *delta-like-3* gene, part of the notch signaling pathway. (Courtesy Dr. Meriel McEntagart, Kennedy-Galton Centre, London.)

recessive spondylocostal dysostosis. Another component of the pathway is *JAGGED1* which, when mutated, results in the dominantly inherited and very variable condition known as Alagille syndrome (arteriohepatic dysplasia) (Figure 9.7). Mutations in *NOTCH2* are a rare cause of Alagille syndrome as well as Hajdu-Cheney syndrome.

### The Sonic Hedgehog–Patched GLI Pathway

The Sonic hedgehog gene (*SHH*) is as well known for its quirky name as for its function. *SHH* induces cell proliferation in a tissue-specific distribution and is expressed in the notochord, the brain, and the zone of polarizing activity of developing limbs. After cleavage and modification by the addition of a cholesterol moiety, the *SHH* protein binds with its receptor, Patched (PTCH), a transmembrane protein. The normal action of PTCH is to inhibit another transmembrane protein called Smoothed (Smo), but when bound by Shh this inhibition is released and a signaling cascade within the cell is activated. The key intracellular targets are the *GLI* (glioma-associated oncogene) family of transcription factors (Figure 9.8).

Molecular defects in any part of this pathway lead to a number of apparently diverse malformation syndromes (see Figure 9.8). Mutations in, or deletions of, *SHH* (chromosome 7q36) cause holoprosencephaly (Figure 9.9), in which the primary defect is incomplete cleavage of the developing brain into separate hemispheres and ventricles. The most severe form of this malformation is cyclopia—the presence of a single central eye. The complexity of early development can be appreciated by the fact that a dozen or so chromosomal regions have so far been implicated in the pathogenesis of holoprosencephaly (p. 222). Mutations in *PTCH* (9q22) result in Gorlin syndrome (nevroid basal cell carcinoma syndrome; Figure 9.10), which comprises multiple basal cell carcinomas, odontogenic

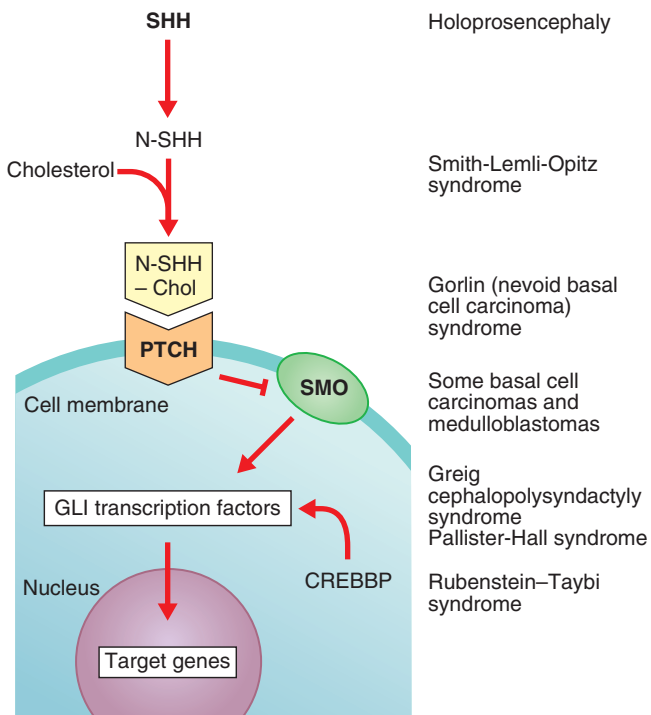
keratocysts, bifid ribs, calcification of the falx cerebri, and ovarian fibromata. Mutations in *SMO* (7q31) are found in some basal cell carcinomas and medulloblastomas. Mutations in *GLI3* (7p13) cause Pallister-Hall and Grieg syndromes, which are distinct entities with more or less the same body systems affected. However, there are also links to other conditions, in particular the very variable Smith-Lemli-Opitz syndrome (SLOS), which may include holoprosencephaly as well as some characteristic facial features, pulmonary segmentation defects, genital anomalies, postaxial polydactyly and syndactyly. This condition is due to a defect in the final step of cholesterol biosynthesis, which in turn may disrupt the binding of SHH with its receptor, PTCH. Some, or all, of the features of SLOS may therefore be due to loss of integrity in this pathway. Furthermore, a cofactor for the GLI proteins, *CREBBP* (16p13) is mutated in Rubenstein-Taybi syndrome (Figure 9.11). Disturbance of different components of the SHH is also clearly implicated in many types of tumor formation.

### Homeobox (*HOX*) Genes

In *Drosophila* a class of genes known as the homeotic genes has been shown to determine segment identity. Incorrect



**FIGURE 9.7 A**, Boy with Alagille syndrome and confirmed mutation in *JAGGED1* who presented with congenital heart disease. **B**, The same boy a few years earlier with his parents. His mother has a pigmentary retinopathy and was positive for the same gene mutation.



**FIGURE 9.8** The Sonic hedgehog (SHH)-Patched (PTCH)-GLI pathway and connection with disease. Different elements in the pathway act as activators (arrows) or inhibitors (bars). The SHH protein is initially cleaved to an active N-terminal form, which is then modified by the addition of cholesterol. The normal action of PTCH is to inhibit SMO, but when SHH is bound by PTCH this inhibition is removed and the downstream signaling proceeds. CREBBP, cAMP response element-binding protein.

expression of these genes results in major structural abnormalities; the *Antp* gene, for example, which is normally expressed in the second thoracic segment, will transform the adult fly's antennae into legs if incorrectly expressed in the head. Homeotic genes contain a conserved 180-base pair (bp) sequence known as the homeobox, which is believed to be characteristic of genes involved in spatial pattern control and development. This encodes a 60-amino-acid domain that binds to DNA in Hox-response enhancers. Proteins from homeobox-containing (or *HOX*) genes are therefore important transcription factors that activate and repress batteries of downstream genes. At least 35 downstream targets are known. The Hox proteins regulate other 'executive' genes that encode transcription factors or morphogen signals, as well as operating at many other levels, on genes that mediate cell adhesion, cell division rates, cell death, and cell movement. They specify cell fate and help to establish the embryonic pattern along the primary (rostro-caudal) axis as well as the secondary (genital and limb bud) axis. They therefore play a major part in the development of the central nervous system, axial skeleton and limbs, the gastrointestinal and urogenital tracts, and external genitalia.

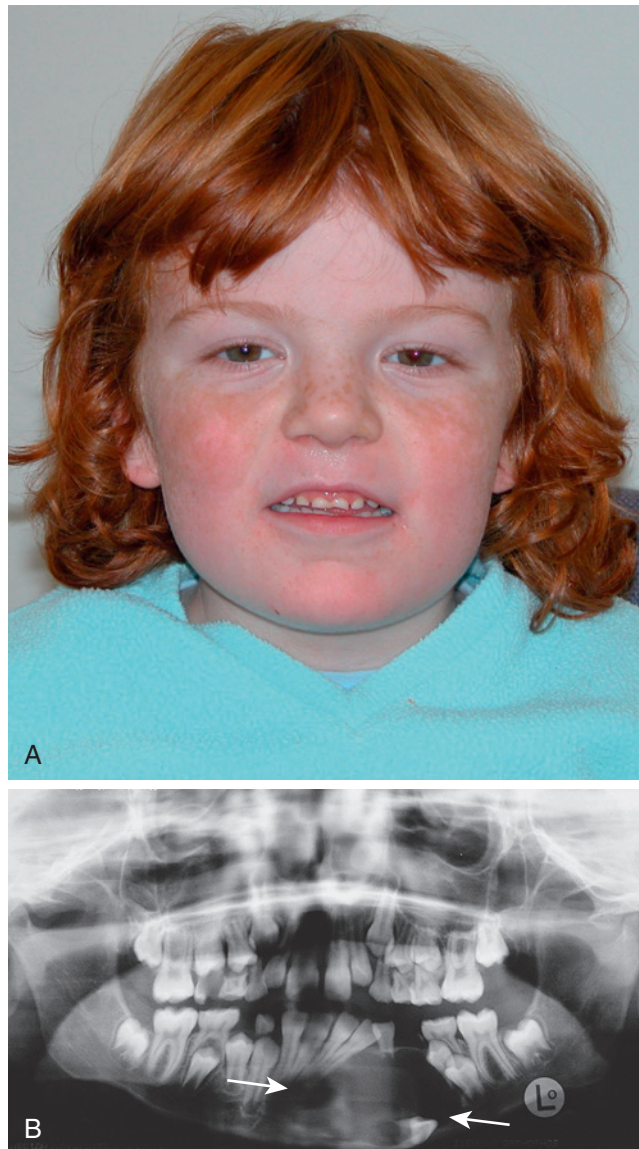
*Drosophila* has eight *Hox* genes arranged in a single cluster, but in humans, as in most vertebrates, there are four homeobox gene clusters containing a total of 39 *HOX* genes (Figure 9.12). Each cluster contains a series of closely linked genes. In vertebrates such as mice, it has been shown that these genes are expressed in segmental units in the hindbrain and in global patterning of the somites formed from axial presomitic mesoderm. In each *HOX* cluster, there is a direct linear correlation

between the position of the gene and its temporal and spatial expression. These observations indicate that these genes play a crucial role in early morphogenesis. Thus, in the developing limb bud (p. 118, see Figure 9.25) *HOXA9* is expressed both anterior to, and before, *HOX10*, and so on.

Mutations in *HOXA13* cause a rare condition known as the hand-foot-genital syndrome. This shows autosomal dominant inheritance and is characterized by shortening of the first and fifth digits, with hypospadias in males and bicornuate uterus in females. Experiments with mouse *Hoxa13* mutants have shown that expression of another gene, *Epha7*, is severely reduced. Therefore, if this gene is not activated by *Hoxa13*, there is failure to form the normal chondrogenic condensations in the primordial distal limb. Mutations in *HOXD13* result in an equally rare limb developmental abnormality known as synpolydactyly. This also shows autosomal dominant inheritance and is characterized by insertion of an additional digit between the third and fourth fingers and the fourth and fifth toes, which are webbed (Figure 9.13). The phenotype in homozygotes is more severe and reported mutations take the form of an increase in the number of residues in a polyalanine tract. This triplet-repeat expansion probably alters the structure and function of the protein, thereby constituting a gain-of-function mutation (p. 20). Mutated *HOXA1* has been found in the rare, recessively inherited, Bosley-Saleh-Alorainy



**FIGURE 9.9** Facial features in holoprosencephaly. The eyes are close together and there is a midline cleft lip because of a failure of normal prolabia development.



**FIGURE 9.10** Gorlin (nevroid basal cell carcinoma) syndrome. **A**, This 6-year-old girl from a large family with Gorlin syndrome has macrocephaly and a cherubic appearance. **B**, Her affected sister developed a rapidly enlarging odontogenic keratocyst (arrows) in the mandible at the age of 9 years, displacing the roots of her teeth.

syndrome, consisting of central nervous system abnormalities, deafness, and cardiac and laryngotracheal anomalies. A mutation in *HOXD10* was found in isolated congenital vertical talus in a large family demonstrating autosomal dominant inheritance, and duplications of *HOXD* have been found in mesomelic limb abnormality syndromes.

Given that there are 39 *HOX* genes in mammals, it is surprising that so few syndromes or malformations have been attributed to *HOX* gene mutations. One possible explanation is that most *HOX* mutations are so devastating that the embryo cannot survive. Alternatively, the high degree of homology between *HOX* genes in the different clusters could lead to functional redundancy so that one *HOX* gene compensates for a loss-of-function mutation in another. In this context *HOX* genes are said to be paralogous because family members from

different clusters, such as *HOXA13* and *HOXD13*, are more similar than adjacent genes in the same cluster.

Several other developmental genes also contain a homeobox-like domain. These include *MSX2*, mutations in which can cause craniosynostosis—premature fusion of the cranial sutures.

### Paired-Box (*PAX*) Genes

The paired-box is a highly conserved DNA sequence that encodes a 130-amino-acid DNA-binding transcription regulator domain. Nine *PAX* genes have been identified in mice and humans. In mice these have been shown to play important roles in the developing nervous system and vertebral column. In humans, loss-of-function mutations in five *PAX* genes have been identified in association with developmental abnormalities (Table 9.2). Waardenburg syndrome type 1 is caused by mutations in *PAX3*. It shows autosomal dominant inheritance and is characterized by sensorineural hearing loss, areas of depigmentation in hair and skin, abnormal patterns of pigmentation in the iris, and widely spaced inner canthi (Figure 9.14). Waardenburg syndrome shows clinical and genetic heterogeneity; the more common type 2 form, in which the inner canthi are not widely separated, may be caused by mutations in *MITF* or *SOX10*, with other cases as yet unexplained.

The importance of expression of the *PAX* gene family in eye development is illustrated by the effects of mutations in *PAX2* and *PAX6*. Mutations in *PAX2* cause the renal-coloboma syndrome, in which renal malformations occur in association with structural defects in various parts of the eye, including the retina and optic nerve. Mutations in *PAX6* lead to absence of the iris, which is known as aniridia (Figure 9.15). This is a key feature of the WAGR syndrome (p. 243), which results from a contiguous gene deletion involving the *PAX6* locus on chromosome 11.

### *SRY*-Type HMG Box (*SOX*) Genes

*SRY* is the Y-linked gene that plays a major role in male sex determination (p. 123). A family of genes known as the *SOX* genes show homology with *SRY* by sharing a 79-amino-acid domain known as the HMG (high-mobility group) box. This HMG domain activates transcription by bending DNA in such a way that other regulatory factors can bind with the promoter regions of genes that encode for important structural proteins. These *SOX* genes are thus transcription regulators and are expressed in specific tissues during embryogenesis. For example, *SOX1*, *SOX2*, and *SOX3* are expressed in the developing mouse nervous system.

In humans it has been shown that loss-of-function mutations in *SOX9* on chromosome 17 cause campomelic dysplasia (Figure 9.16). This very rare disorder is characterized by bowing of the long bones, sex reversal in chromosomal males, and very poor long-term survival. In-situ hybridization studies

**Table 9.2** Developmental Abnormalities Associated with *PAX* Gene Mutations

Gene	Chromosome Location	Developmental Abnormality
<i>PAX2</i>	10q24	Renal-coloboma syndrome
<i>PAX3</i>	2q35	Waardenburg syndrome type 1
<i>PAX6</i>	11p13	Aniridia
<i>PAX8</i>	2q12	Absent or ectopic thyroid gland
<i>PAX9</i>	14q12	Oligodontia



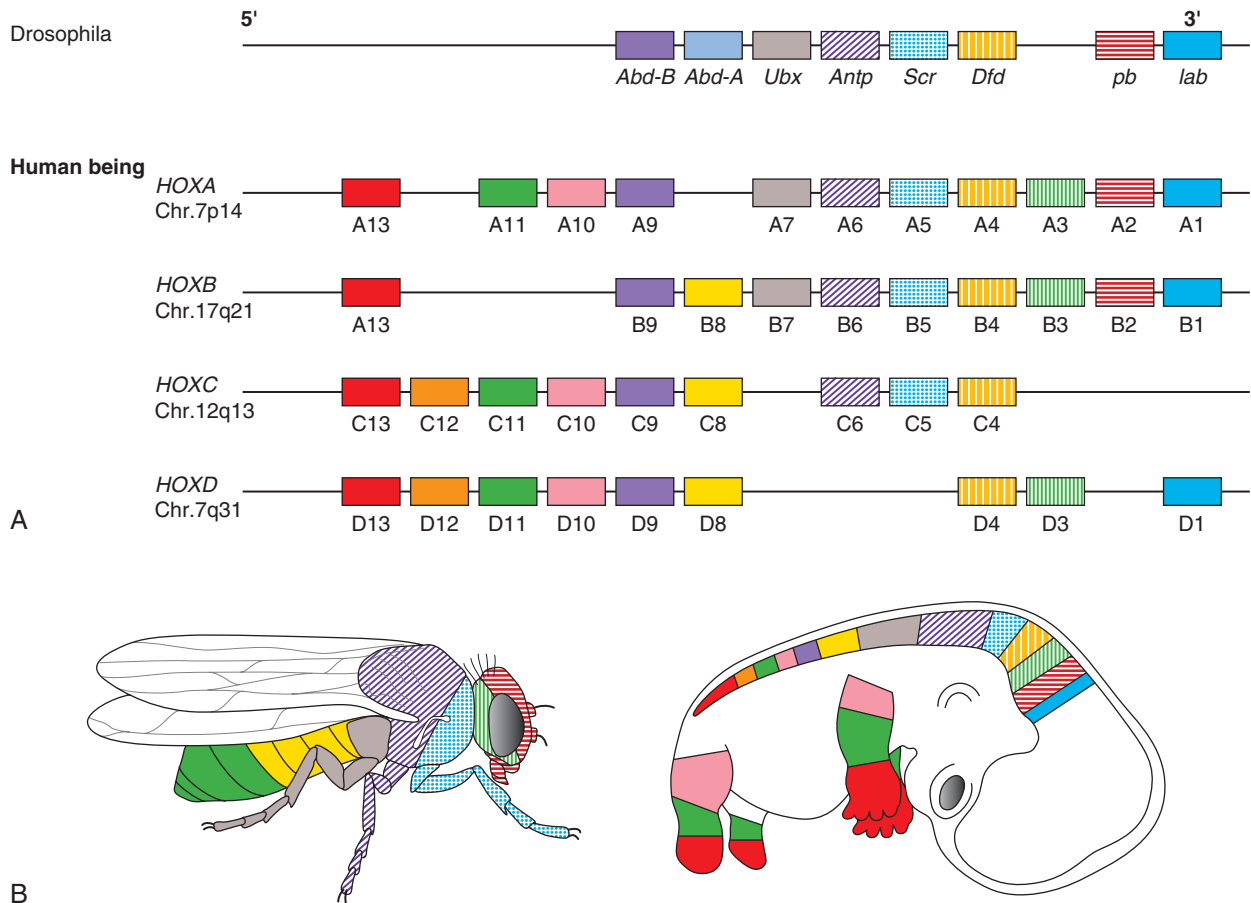
**FIGURE 9.11** A baby with characteristic facial features (A) of Rubenstein-Taybi syndrome, angulated thumbs (B), and postaxial polydactyly of the feet (C). A young adult (D) with the same condition, though more mildly affected.

in mice have shown that *SOX9* is expressed in the developing embryo in skeletal primordial tissue, where it regulates type II collagen expression, as well as in the genital ridges and early gonads. *SOX9* is now thought to be one of several genes that are expressed downstream of *SRY* in the process of male sex determination (p. 123). Mutations in *SOX10* are one cause of Waardenburg syndrome type 2 and may include a peripheral neuropathy as well as Hirschsprung disease. Mutations in *SOX2* (3q26) have been shown to cause anophthalmia or microphthalmia, but also a wider syndrome of esophageal atresia and genital hypoplasia in males – the anophthalmia-esophageal-genital syndrome.

### T-Box (*TBX*) Genes

The T gene in mice plays an important role in specification of the paraxial mesoderm and notochord differentiation. Heterozygotes for loss-of-function mutations have a short tail and malformed sacral vertebrae. This gene, which is also known as *Brachyury*, encodes a transcription factor that contains both activator and repressor domains. It shows homology with a series of genes through the shared possession of the T domain, which is also referred to as the T-box. These T-box or *TBX* genes are dispersed throughout the human genome, with some family members existing in small clusters. One of these clusters on chromosome 12 contains *TBX3* and *TBX5*. Loss-of-function





**FIGURE 9.12 A**, *Drosophila* has eight *Hox* genes in a single cluster whereas there are 39 *HOX* genes in humans, arranged in four clusters located on chromosomes 7p, 17q, 12q, and 2q for the A, B, C, and D clusters, respectively. **B**, Expression patterns of *Hox* and *HOX* genes along the rostro-caudal axis in invertebrates and vertebrates, respectively. In vertebrates the clusters are *paralogous* and appear to compensate for one another. (Redrawn from Veraksa A, Del Campo M, McGinnis W: *Developmental patterning genes and their conserved functions: from model organisms to humans*. *Mol Genet Metab* 2000;69:85–100, with permission.)



**FIGURE 9.13** Clinical (**A**) and (**B**) radiographic views of the hands in synpolydactyly due to mutated *HOXD13*.



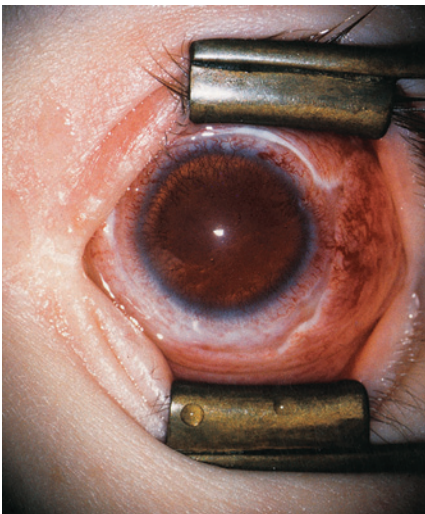
**FIGURE 9.14** Iris heterochromia and marked dystopia canthorum in an infant with Waardenburg syndrome type 1, caused by a mutation in *PAX3*.

mutations in *TBX3* cause the ulnar-mammary syndrome in which ulnar ray developmental abnormalities in the upper limbs are associated with hypoplasia of the mammary glands. Loss-of-function mutations in *TBX5* cause the Holt-Oram syndrome. This autosomal dominant disorder is characterized by congenital heart abnormalities, most notably atrial septal defects, and upper limb radial ray reduction defects that can vary from mild hypoplasia (sometimes duplication) of the thumbs to almost complete absence of the forearms. *TBX6* is implicated in congenital scoliosis, autosomal dominant and recessive forms of spondylocostal dysostosis, and Müllerian aplasia (abnormalities of the female genital tract).

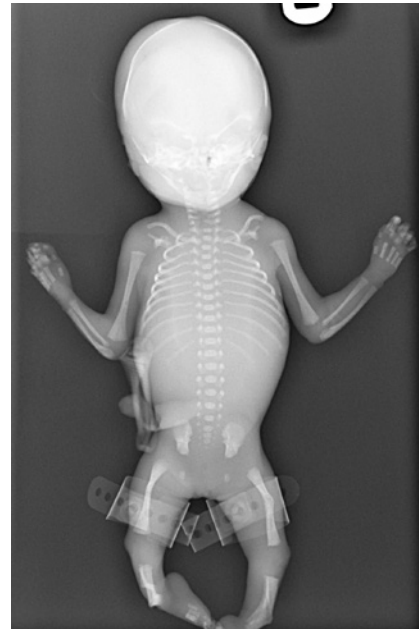
### Zinc Finger Genes

The term **zinc finger** refers to a finger-like loop projection consisting of a series of four amino acids that form a complex with a zinc ion. Genes that contain a zinc finger motif act as transcription factors through binding of the zinc finger to DNA. Consequently they are good candidates for single-gene developmental disorders (Table 9.3).

For example, a zinc finger motif-containing (zfm-c) gene known as *GLI3* on chromosome 7 (as mentioned, a component of the SHH pathway) has been implicated as the cause of two developmental disorders. Large deletions or translocations involving *GLI3* cause Greig cephalopolysyndactyly, which is characterized by head, hand, and foot abnormalities such as polydactyly and syndactyly (Figure 9.17A). In contrast,



**FIGURE 9.15** An eye showing absence of the iris (aniridia). The cornea shows abnormal vascularization. (Courtesy Mr. R. Gregson, Queen's Medical Centre, Nottingham, UK.)



**FIGURE 9.16** Campomelic dysplasia. This skeletal dysplasia is characterized by angulation of the long bones, especially in the legs, very small scapulae, and sex reversal in males. Severe and life-threatening respiratory distress in the neonatal period is usual. It is caused by mutations in the *SOX9* gene.

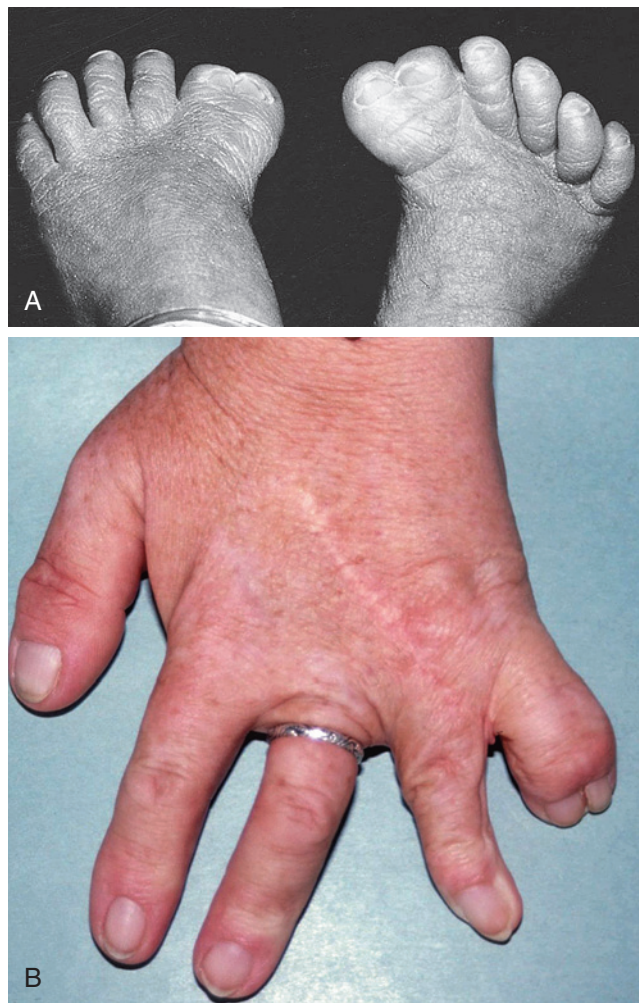
frameshift mutations in *GLI3* have been reported in the Pallister-Hall syndrome (see Figure 9.17B), in which the key features are polydactyly, hypothalamic hamartomata and imperforate anus.

Mutations in another zfm-c gene known as *WT1* on chromosome 11 can cause both Wilms' tumor and a rare developmental disorder, the Denys-Drash syndrome, in which the external genitalia are ambiguous and there is progressive renal failure as a result of nephritis. Mutations in two other zfm-c genes, *ZIC2* and *ZIC3*, have been shown to cause holoprosencephaly and laterality defects, respectively.

Just as **polarity** is a key concept in development, so too is **laterality**, with implications for the establishment of a normal left-right body axis. In very early development, integrity of many of the same gene families previously mentioned—Nodal, SHH, and Notch—is essential to the establishment of this axis. Clinically, **situs solitus** is the term given to normal left-right asymmetry and **situs inversus** to reversal of the normal arrangement. Up to 25% of individuals with situs inversus have an autosomal recessive condition—Kartagener syndrome, or ciliary dyskinesia. Other terms used are **isomerism sequence**, **heterotaxy**, **asplenia/polyasplenia**, and **Ivemark syndrome**. Laterality defects are characterized by abnormal positioning of unpaired

**Table 9.3** Developmental Abnormalities Associated with Genes Containing a Zinc Finger Motif

Gene	Chromosome Location	Developmental Abnormality
<i>GLI3</i>	7p13	Greig syndrome and Pallister-Hall syndrome
<i>WT1</i>	11p13	Denys-Drash syndrome
<i>ZIC2</i>	13q32	Holoprosencephaly
<i>ZIC3</i>	Xq26	Laterality defects



**FIGURE 9.17** **A**, The feet of a child with Greig cephalopolysyndactyly. Note that they show both preaxial polydactyly (extra digits) and syndactyly (fused digits). **B**, The left hand of a woman with Pallister-Hall syndrome and a proven mutation in *GLI3*. Note the postaxial polydactyly and the surgical scar, where an extra digit arising from between the normal metacarpal rays (mesoaxial polydactyly) was removed.

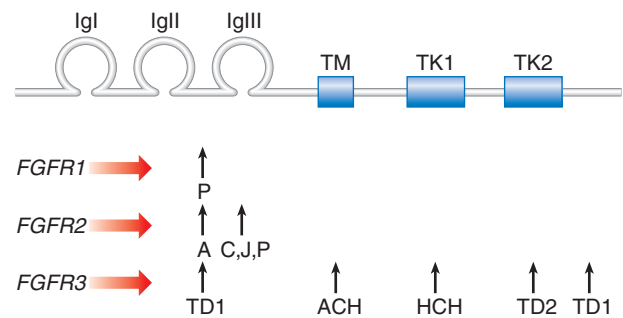
organs such as the heart, liver, and spleen, and more than 20 genes are now implicated from studies in vertebrates, with a number identified in humans by the study of affected families, with all of the main patterns of inheritance represented.

### Signal Transduction ('Signaling') Genes

Signal transduction is the process whereby extracellular growth factors regulate cell division and differentiation by a complex pathway of genetically determined intermediate steps. Mutations in many of the genes involved in signal transduction play a role in causing cancer (p. 181). In some cases they can also cause developmental abnormalities.

### The *RET* Proto-Oncogene

The proto-oncogene *RET* on chromosome 10q11.2 encodes a cell-surface tyrosine kinase. Gain-of-function mutations, whether inherited or acquired, are found in a high proportion of medullary thyroid cancers (Chapter 14). Loss-of-function mutations in *RET* have been identified in approximately 50% of familial cases of Hirschsprung disease, in which there is failure



**FIGURE 9.18** Structure of the fibroblast growth factor receptor (*FGFR*). Arrows indicate the location of mutations in the craniosynostosis syndromes and achondroplasia group of skeletal dysplasias. *Ig*, Immunoglobulin-like domain; *TM*, transmembrane domain; *TK*, tyrosine kinase domain; *P*, Pfeiffer syndrome; *A*, Apert syndrome; *C*, Crouzon syndrome; *J*, Jackson-Weiss syndrome; *TD*, thanatophoric dysplasia; *ACH*, achondroplasia; *HCH*, hypochondroplasia.

of migration of ganglionic cells to the submucosal and myenteric plexuses of the large bowel. The clinical consequences are usually apparent shortly after birth when the child presents with abdominal distension and intestinal obstruction.

### FGF Receptors

FGFs play key roles in embryogenesis, including cell division, migration, and differentiation. The transduction of extracellular FGF signals is mediated by a family of four transmembrane tyrosine kinase receptors. These are the fibroblast growth factor receptors (FGFRs), each of which contains three main components: an extracellular region with three immunoglobulin-like domains, a transmembrane segment, and two intracellular tyrosine kinase domains (Figure 9.18).

Mutations in the genes that code for FGFRs have been identified in two groups of developmental disorders (Table 9.4), and these are activating or gain-of-function mutations (p. 20). These are the craniosynostosis syndromes and the achondroplasia family of skeletal dysplasias. The craniosynostosis syndromes, of which Apert syndrome (Figure 9.19) is the best known, are characterized by premature fusion of the cranial sutures, often in association with hand and foot abnormalities such as syndactyly (fusion of the digits). Apert syndrome is caused by a mutation in one of the adjacent *FGFR2* residues in the peptides that link the second and third immunoglobulin loops (see Figure 9.18). In contrast, mutations in the third

**Table 9.4** Developmental Disorders Caused by Mutations in Fibroblast Growth Factor Receptors

Gene	Chromosome	Syndrome
<b>Craniosynostosis Syndromes</b>		
<i>FGFR1</i>	8p11	Pfeiffer
<i>FGFR2</i>	10q25	Apert Crouzon Jackson-Weiss Pfeiffer
<i>FGFR3</i>	4p16	Crouzon (with acanthosis nigricans)
<b>Skeletal Dysplasias</b>		
<i>FGFR3</i>	4p16	Achondroplasia Hypochondroplasia Thanatophoric dysplasia



**FIGURE 9.19** Apert syndrome, due to mutated *FGFR2*. Views of the face (**A**), hand (**B**), and foot (**C**) of a child. An affected adult is shown in (**D**), (**E**), and (**F**).

immunoglobulin loop can cause either Crouzon syndrome, in which the limbs are normal, or Pfeiffer syndrome, in which the thumbs and big toes are broad. Achondroplasia is the most commonly encountered form of genetic short stature (Figure 9.20). The limbs show proximal ('rhizomelic') shortening and the head is enlarged with frontal bossing. Intelligence and life expectancy are normal. Achondroplasia is almost always caused by a mutation in, or close to, the transmembrane domain of *FGFR3*. The common transmembrane domain mutation, G380R or c.1138G>A, results in the replacement of a glycine residue by arginine—an amino acid never normally found in cell membranes. This in turn appears to enhance dimerization of the protein that catalyzes downstream signaling. Hypochondroplasia, a milder form of skeletal dysplasia with similar trunk and limb changes but normal head shape and size, is caused by mutations in the proximal tyrosine kinase domain (intracellular) of *FGFR3*. Finally, thanatophoric dysplasia, a much more severe and invariably lethal form of skeletal dysplasia, is caused

by mutations in either the peptides linking the second and third immunoglobulin domains (extracellular) of *FGFR3*, or the distal *FGFR3* tyrosine kinase domain. The mechanism by which these mutations cause skeletal shortening is not fully understood at present. The mutations cannot have loss-of-function effects as children with the Wolf-Hirschhorn syndrome (p. 243), which is due to chromosome 4p microdeletions that include *FGFR3*, do not show similar skeletal abnormalities.

### The Pharyngeal Arches

The pharyngeal (or branchial) arches correspond to the gill system of lower vertebrates and appear in the fourth and fifth weeks of development. Five (segmented) pharyngeal arches in humans arise lateral to the structures of the head (Figure 9.21) and each comprises cells from the three germ layers and the neural crest. The lining of the pharynx, thyroid, and parathyroids arises from the endoderm, and the outer



**FIGURE 9.20** Two young patients with achondroplasia. **(A)** An infant, showing typical frontal bossing and excess skin folds due to short long bones. **(B)** An older child who is part of a family with achondroplasia.

epidermal layer arises from the **ectoderm**. The musculature arises from the **mesoderm**, and bony structures from **neural crest** cells. Separating the arches are the pharyngeal clefts externally and the pharyngeal pouches internally; these have important destinies. Numbered from the rostral end, the first arch forms the jaw and muscles of mastication; the first cleft is destined to be the external auditory meatus, and the first pouch the middle ear apparatus. The second arch forms the hyoid apparatus and muscles of facial expression, whereas the third pouch develops into the thymus, and the third and fourth pouches become the parathyroids. The arteries within the arches have important destinies too and, after remodeling, give rise to the aortic and pulmonary arterial systems. Some of the syndromes, malformations, inheritance patterns and genetic mechanisms associated with the first and second pharyngeal arches are listed in Table 9.5. One of these, branchio-oculo-facial syndrome (BOFS), is illustrated in Figure 9.22. However, the most well-known condition due to disturbed development of pharyngeal structures—the third and fourth pouches—is DiGeorge syndrome, also known as velocardiofacial syndrome, and well described earlier by Sedláčková of Prague in 1955. This is covered in more detail in Chapter 17 (p. 245) and results from a 3Mb submicroscopic chromosome deletion at band 22q11.2 with the loss of some 30 genes. Studies in mice (the equivalent, or **syntenic**, region is on mouse chromosome 16) suggest that the most significant gene loss is that of *Tbx1*, strongly expressed throughout the pharyngeal apparatus. Heterozygous *Tbx1* knock-out mice show hypoplastic or absent fourth pharyngeal arch arteries, suggesting that *TBX1* in humans

is the key. Indeed, mutations in this gene have been found in some congenital heart abnormalities and it is possible that *TBX1* is the key gene for other elements of the phenotype.

### The Role of Cilia in Developmental Abnormalities

In recent years, the vital role of the humble cilium in driving movement or particle flow across epithelial surfaces has become increasingly apparent. As with other areas of cell and molecular biology, we learn most about motile cilia when they are dysfunctional—the result may be major developmental abnormalities.

Cilia are the equivalent of flagella in wider biology and they share structural identity. They are hair-like protrusions from the cell surface (Figure 9.23), up to 20  $\mu\text{m}$  long and, present in large numbers on the apical cell surface, beat in coordinated waves. In cross-section they consist of a scaffold of nine microtubule doublets surrounding a central pair. The central and outer doublets are connected by radial spokes, which produce the force necessary to bend the cilium; dynein arms facilitate this movement. They clear mucus from the respiratory epithelium, drive sperm along the Fallopian tube, and move cerebrospinal fluid in the cavities of the central nervous system. In development, the cilia at the organizational node of the vertebrate embryo conduct a circular motion, wafting molecules unidirectionally and helping to establish left-right asymmetry.

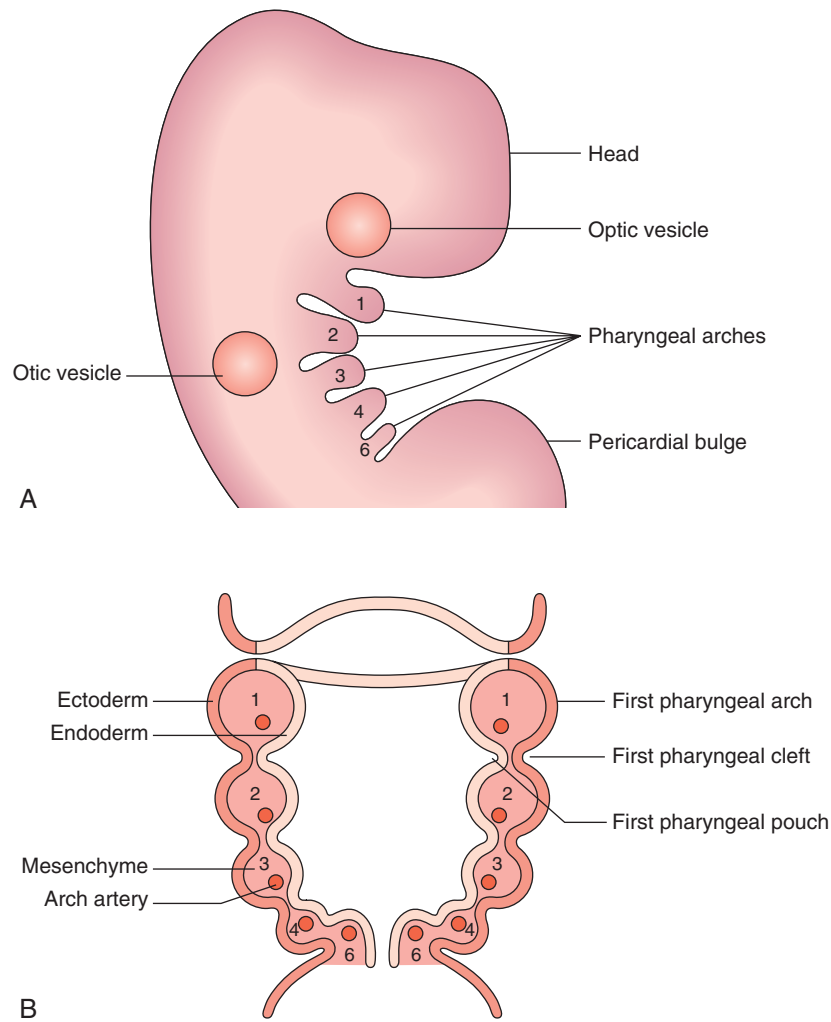
Apart from their obvious mechanical function, which conceptually is straightforward, it appears increasingly likely that cilia behave like molecular antennae that sense extracellular signaling molecules. The Sonic hedgehog and Wnt signaling pathways depend to an extent on cilia functional integrity for optimal signaling. Defective cilia function can therefore impact on a broad range of developmental processes and pathways. Defects in the cilia proteins themselves lead to wide-ranging phenotypic effects that include retinal degeneration, anosmia, renal, hepatic, and pancreatic cyst formation, postaxial polydactyly, and situs inversus. These recognizable syndromes are referred to as ‘ciliopathies’ (Table 9.6). One of these, short-rib polydactyly syndrome, which follows autosomal recessive inheritance and is due to mutated *DYNC2H1* (among others), is shown in Figure 9.24. The features of the listed syndromes in Table 9.6 overlap with many other multiple congenital abnormality syndromes and the role of cilia in developmental genetics cannot be underestimated.

### The Limb as a Developmental Model

Four main phases are recognized in limb development: (1) initiation, (2) specification, (3) tissue differentiation, and (4) growth. Understanding of these stages and their molecular mechanisms continues to grow and insights have been gleaned from the study of limb development in chicks and mice in particular, as well as elucidating the causes of various limb abnormalities in man.

#### Initiation and Specification

Limb bud formation is thought to be initiated at approximately 28 days by a member of the *FGF* family as illustrated by the development of an extra limb if *FGF1*, *FGF2*, or *FGF4* is applied to the side of a developing chick embryo. During normal limb initiation *FGF8* transcripts have been identified in



**FIGURE 9.21** The pharyngeal (or branchial) apparatus. The lateral view **(A)** shows the five pharyngeal arches close to the embryonic head and the cross-section **(B)** shows the basic arrangement from which many head and neck structures, as well as the heart, develop. Humans and mice do not have arch no. 5. (Redrawn from Graham A, Smith A 2001 *Patterning the pharyngeal arches*. *Bioessays* 23:54–61, with permission of Wiley-Liss Inc., a subsidiary of John Wiley & Sons, Inc.)



**FIGURE 9.22** Branchio-oculo-facial syndrome (BOFS), a condition affecting the 1st and 2nd pharyngeal arches. **A**, a young child with a pseudocleft of the upper lip, flattened nasal tip and antverted nares; **B**, the same child showing a typical cutaneous branchial sinus lesion; **C**, the child with his mother (who also has small ears) and grandmother – all clearly affected with pseudoclefts.

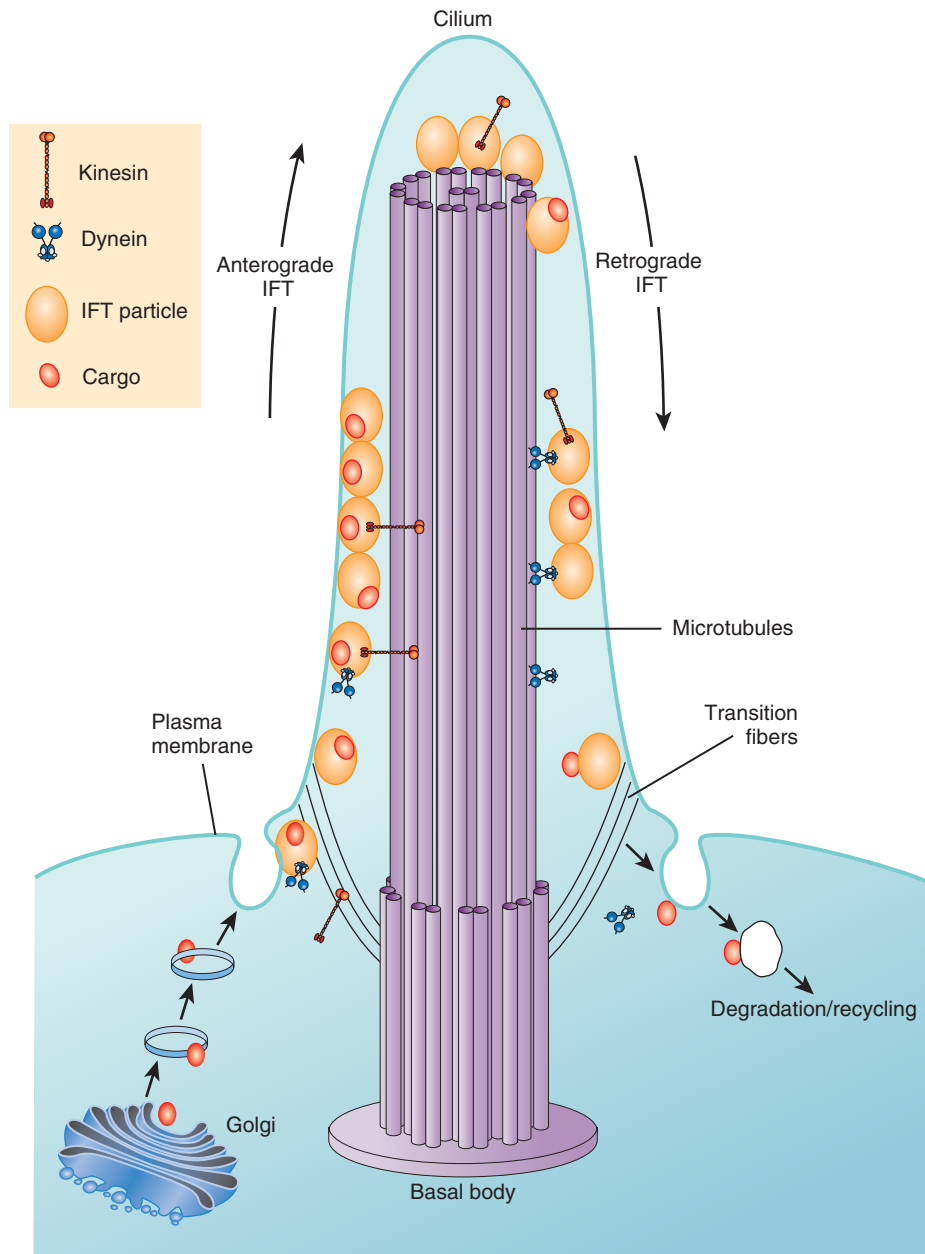
**Table 9.5** Some Syndromes and Malformations Associated With the First and Second Pharyngeal Arches

Syndrome	Malformations	Inheritance	Mechanisms
Oculo-auriculo-vertebral spectrum (OAVS; Goldenhar syndrome)	Hemifacial microsomia, ear malformations; epibulbar dermoids; occasional clefts; (cervical vertebral anomalies)	Usually sporadic. Occasional AD and AR families reported	Probable non-genetic factors Possible locus at 14q32.1
Treacher Collins syndrome	Hypoplasia of the maxilla and mandible; downslanting palpebral fissures with coloboma of the lower lid; cleft palate; hearing impairment	AD	Mutation in <i>TCOF1</i> gene
Branchio-oculo-facial syndrome (BOFS)	Branchial cleft sinus defects; a cleft or pseudocleft lip/palate; ocular anomalies including microphthalmia and lacrimal duct obstruction	AD	Mutation in <i>TFAP2A</i> gene
Branchio-oto-renal (BOR) syndrome	Long, narrow face; aplasia or stenosis of lacrimal duct; ear anomalies—external and inner—and preauricular pits	AD	Mutation in <i>EYA1</i> , <i>SIX5</i> , possible locus at 1q31
Pierre-Robin sequence	Micrognathia, cleft palate, glossoptosis (posteriorly placed tongue); if syndromic, may be associated with limb anomalies and or congenital heart disease	Various: sporadic if occurring as an isolated malformation complex; syndromic forms—both AD and AR families reported	Sporadic cases may be a deformation sequence secondary to oligohydramnios. One AD form segregates with a 75 kb deletion at 17q24, which may affect expression of <i>SOX9</i> (campomelic dysplasia)
Townes-Brock syndrome	Malformed ('satyr') ears, sensorineural hearing loss, preauricular skin tags; (imperforate anus, triphalangeal thumbs, cardiac/renal defects)	AD	Mutation in <i>SALL1</i>
Auriculo-condylar syndrome	Prominent, malformed ears; abnormal temporomandibular joint; microstomia	AD	One locus, mapped to 1p21-q23
Oro-facial-digital (OFD) syndromes (types I to X)	Cleft or lobulated tongue; cleft palate; oral frenulae; (digital anomalies—brachydactyly, polydactyly, syndactyly, clinodactyly)	XLD (OFD1, OFD7) XLR (OFD8, OFD9) AR (OFD2, OFD3, OFD4, OFD5), OFD6, OFD9) AD (OFD7)	OFD1 due to mutation in <i>CXORF5</i> (Xp22)
Oto-palato-digital (OPD) syndrome	Prominent supraorbital ridge, wide nasal bridge, downslanting palpebral fissures, low set ears, microstomia, micrognathia; (skeletal abnormalities—restricted growth, narrow thorax, platyspondyly, bowed long bones)	XL semidominant	Mutation in <i>FLNA</i> (Xq28)

AD, Autosomal dominant; AR, autosomal recessive; XLD, X-linked dominant; XLR, X-linked recessive.

**Table 9.6** The Human Ciliopathies: Those Diseases of Development Known to Be Due to Defective Cilia

Disease/Syndrome	Gene	Chromosome Locus	Body System(s) Affected
Alstrom syndrome	<i>ALMS1</i>	2p13	Retina, adipose, endocrine, heart
Jeune asphyxiating thoracic dystrophy	<i>IFT80</i>	15q13	Skeleton
Bardet-Biedl syndrome	<i>BBS1-BBS14</i>	Multiple	Multisystem, including retina, kidney, skeleton
Cranioectodermal dysplasia (Sensenbrenner syndrome)	<i>IFT122</i>	3q21.3	Kidney, liver
	<i>WDR35</i>	2p24.1	
	<i>IFT43</i>	14q24.3	
	<i>WDR19</i>	4p14	
Ellis-van Crefeld syndrome	<i>EVC1</i> , <i>EVC2</i>	4p16	Skeleton, heart
Joubert syndrome	<i>JBTS1</i> (+ others)	9q34.3	Brain
Leber congenital amaurosis	<i>GUCY2D</i> , <i>RPE65</i> (+ others)	17p13, 11p31 (+ others)	Retina
McKusick-Kaufman syndrome	<i>BBS6</i>	20p12	Limb, heart, urogenital tract
Meckel-Gruber syndrome	<i>MKS1</i> (+ others)	17q23 (+ others)	Brain, kidney, liver
Nephronophthisis (types 1–4)	Nephrocyston (+ others)	Multiple	Kidney
Oro-facio-digital syndrome type 1	<i>OFD1</i> (+ others)	Xp.22 (+ others)	Skeleton (limb, face)
Polycystic kidney disease	Multiple	Multiple	Kidney
Primary ciliary dyskinesia (Kartegener syndrome)	Multiple	Multiple	Multi-system
Senior-Loken syndrome	Multiple	Multiple	Retina, kidney
Short-rib polydactyly syndrome	<i>DYNC2H1</i>	11q13	Skeleton, kidney, urogenital tract



**FIGURE 9.23** The structure of a cilium. Nine microtubule doublets provide the main scaffold and surround one microtubule doublet in the center.

mesenchyme near the initiation site. *FGF8* expression is probably controlled by *HOX* genes, which determine limb type (forelimb or hindlimb) and number.

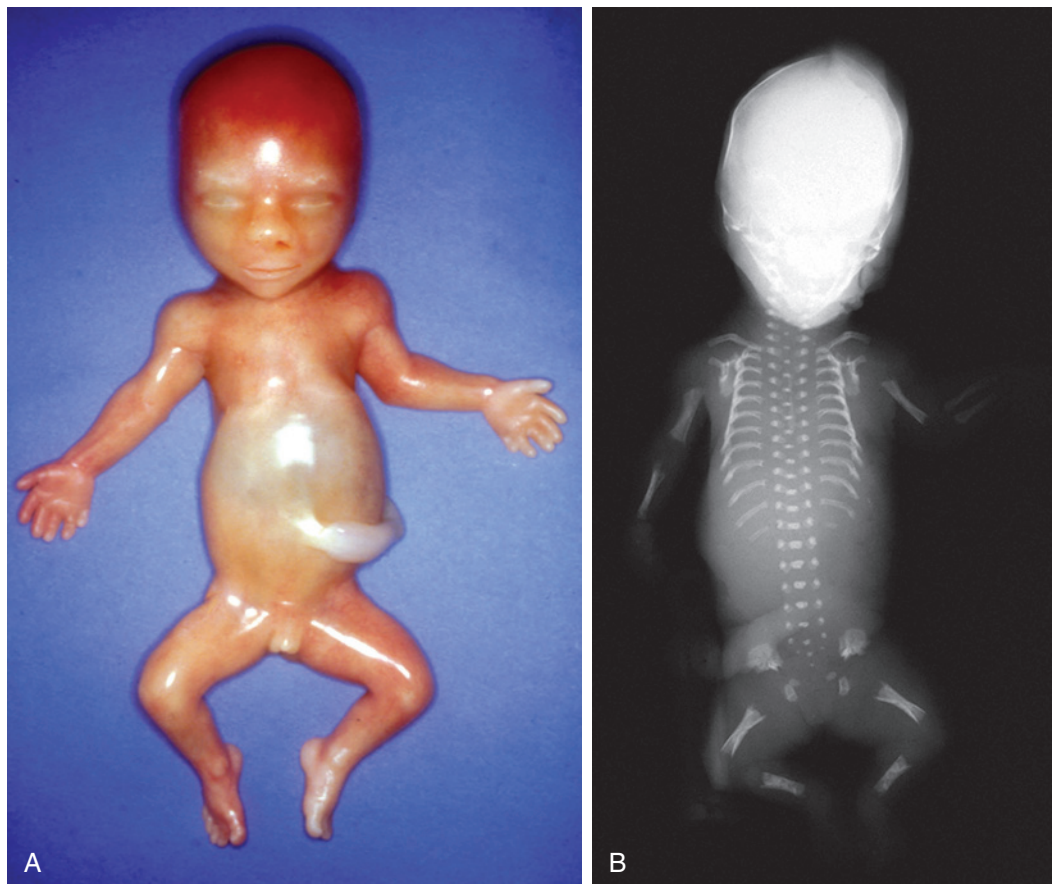
### Tissue Differentiation and Growth

Once limb formation has been initiated, a localized area of thickened ectoderm at the limb tip, known as the **apical ectodermal ridge (AER)**, produces growth signals such as *FGF4* and *FGF8*, which maintain further growth and establish the proximo-distal axis (Figure 9.25). Expression of the gene *TP63* is crucial for sustaining the AER and, when this gene is mutated, split hand-foot malformations result, often together with oral clefting and other anomalies—ectrodactyly-ectodermal dysplasia-clefting syndrome. Signals from another localized area on the posterior margin of the developing bud, known as the **zone of polarizing activity**, determine the anteroposterior axis. One of these

signals is *SHH* (p. 107), which acts in concert with other *FGF* genes, *GLI3*, and another gene family, which produces BMPs. Another morphogen, retinoic acid, is believed to play a major role at this stage in determining development at the anterior margin of the limb bud.

Subsequent development involves the activation of genes from the *HOXA* and *HOXD* clusters in the undifferentiated proliferating mesenchymal cells beneath the AER. This area is known as the progress zone. Cells in different regions express different combinations of *HOX* genes that determine local cell proliferation, adhesion, and differentiation. Downstream targets of the *HOX* gene clusters remain to be identified. Other genes that clearly have a key role are those of the *T-box* family, previously discussed, and *SALL4*, which is mutated in Okinohira syndrome (radial ray defects with abnormal eye movements resulting from congenital palsy affecting the sixth cranial nerve).





**FIGURE 9.24** Short-rib polydactyly syndrome. **A**, The chest of the fetus is narrow and postaxial polydactyly affects all four limbs. **B**, As seen in this x-ray, the ribs of the fetus are very short.

FGFs continue to be important during the later stages of limb development. In this context it becomes easy to understand why limb abnormalities are a feature of disorders such as Apert syndrome (see Figure 9.19), in which mutations have been identified in the extracellular domains of *FGFR2*. Wnt signaling is also integral to limb development and homozygous (or compound heterozygous) mutations of *LRP4*, the protein of which forms a complex with Frizzled in the Wnt canonical pathway (see Figure 9.5), give rise to the condition Cenani-Lenz syndrome, a condition characterized by digital fusion/syndactyly, oligodactyly, renal anomalies, and facial dysmorphism.

### Developmental Genes and Cancer

Several genes that play important roles in embryogenesis have also been shown to play a role in causing cancer (Table 9.7).

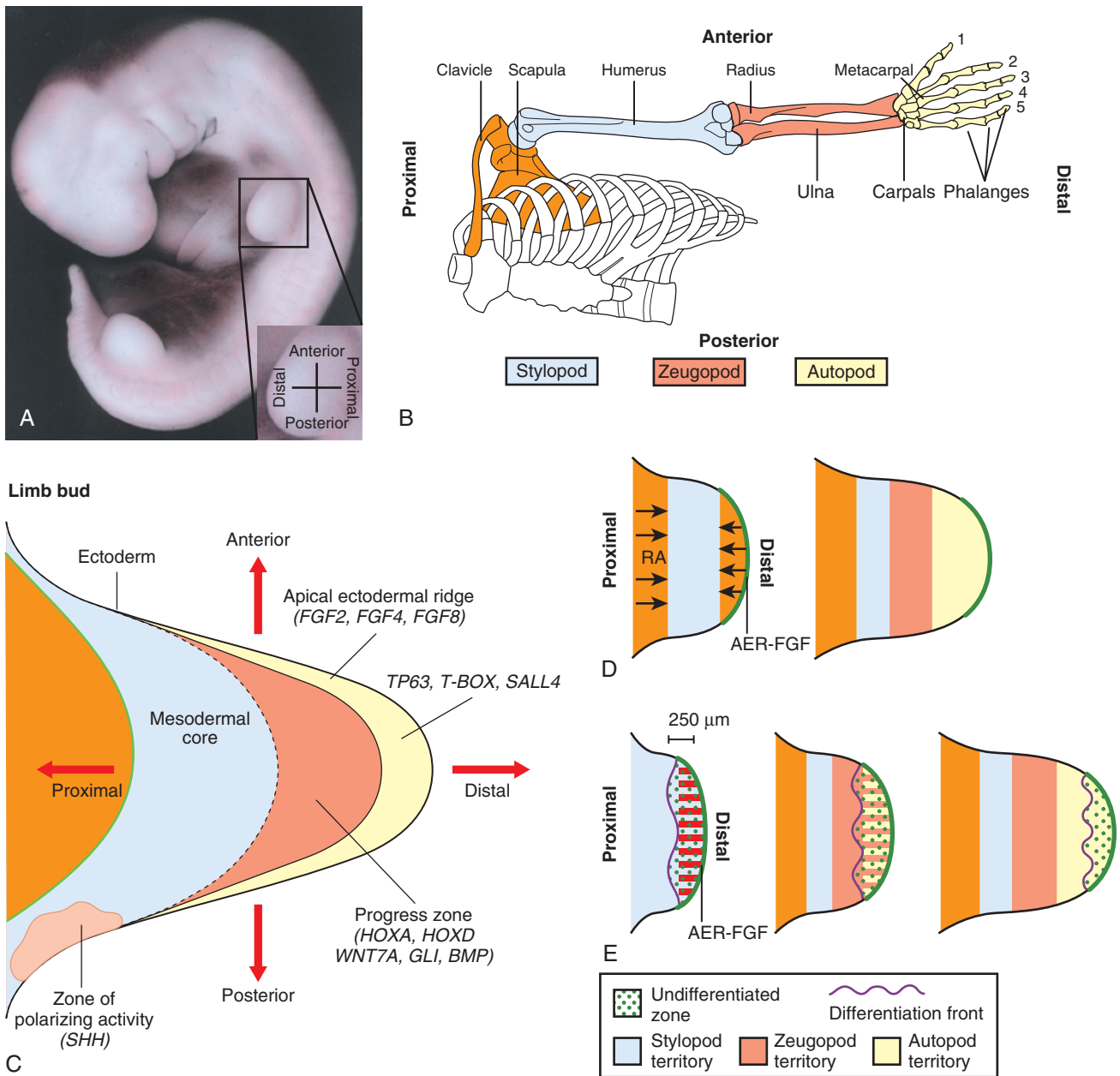
This is not surprising, given that many developmental genes are expressed throughout life in processes such as signal transduction and signal transcription (see Figure 14.5, p. 181). It has been shown that several different mechanisms can account for the phenotypic diversity demonstrated by these so-called teratogenes.

### Gain-of-Function Versus Loss-of-Function Mutations

Mention has already been made of the causal role of the *RET* proto-oncogene in familial Hirschsprung disease, as well as in both inherited and sporadic medullary thyroid cancer (p. 113). The protein product encoded by *RET* consists of three main domains: an extracellular domain that binds to a glial cell line–derived neurotrophil factor, a transmembrane domain,

**Table 9.7** Genes that can Cause Both Developmental Anomalies and Cancer

Gene	Chromosome	Developmental Anomaly	Cancer
<i>PAX3</i>	2q35	Waardenburg syndrome type 1	Alveolar rhabdomyosarcoma
<i>KIT</i>	4q12	Piebaldism	Mast cell leukemia
<i>PTCH</i>	9q22	Gorlin syndrome	Basal cell carcinoma
<i>RET</i>	10p11	Hirschsprung disease	MEN2A, MEN2B, medullary thyroid carcinoma
<i>WT1</i>	11p13	Denys-Drash syndrome	Wilms' tumor



**FIGURE 9.25** Simplified representation of vertebrate limb development. **A**, The emerging limb bud in a vertebrate embryo, with axes defined. **B**, Diagram of the human upper limb skeleton, the colors of the component parts corresponding to the regions depicted in **(C)**, **(D)** and **(E)**. **C**, The various developmental regions of the limb bud, with the expression regions of key genes highlighted. **D**, **E**, The role of retinoic acid (RA) and FGF in determining segmental regions within the limb bud.

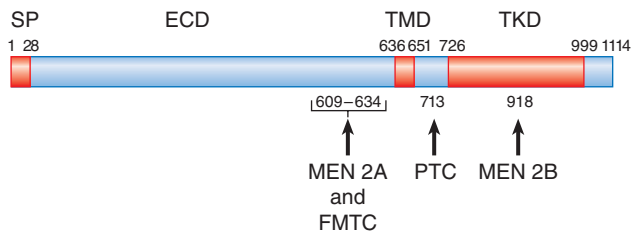
and an intracellular tyrosine kinase domain that activates signal transduction (Figure 9.26). Mutations causing loss-of-function result in Hirschsprung disease. These include whole gene deletions, small intragenic deletions, nonsense mutations, and splicing mutations leading to synthesis of a truncated protein.

In contrast, mutations causing a gain-of-function effect result in either type 2A or type 2B multiple endocrine neoplasia (MEN). These disorders are characterized by a high incidence of medullary thyroid carcinoma and pheochromocytoma. The activating mutations that cause MEN-2A are clustered in five cysteine residues in the extracellular domain. MEN-2B, which differs from MEN-2A, in that affected individuals are tall and

thin, is usually caused by a unique mutation in a methionine residue in the tyrosine kinase domain.

### Somatic Rearrangements

Activation of the *RET* proto-oncogene can occur by a different mechanism whereby the genomic region encoding the intracellular domain is juxtaposed to one of several activating genes that are normally preferentially expressed in the thyroid gland. The newly formed hybrid *RET* gene produces a novel protein whose activity is not ligand dependent. These somatic rearrangements are found in a high proportion of papillary thyroid carcinomas, which show a particularly high incidence in



**FIGURE 9.26** The *RET* proto-oncogene. The most common mutation sites in the different clinical entities associated with *RET* are indicated. Numbers refer to amino-acid residues. *SP*, signal peptide; *ECD*, extracellular domain; *TMD*, transmembrane domain; *TKD*, tyrosine kinase domain; *MEN*, multiple endocrine adenomatosis; *FMTC*, familial medullary thyroid carcinoma. The arrow above *PTC* (papillary thyroid carcinoma) indicates the somatic rearrangement site for the formation of new hybrid forms of *RET*. (Adapted from Pasini B, Ceccherini I, Romeo G 1996 *RET* mutations in human disease. *Trends Genet* 12:138–144.)

children who were exposed to radiation following the Chernobyl accident in 1986.

*PAX3* provides another example of a developmental gene that can cause cancer if it is fused to new DNA sequences. A specific translocation between chromosomes 2 and 13 that results in a new chimeric transcript leads to the development in children of a rare lung tumor called alveolar rhabdomyosarcoma.

### Positional Effects and Developmental Genes

The discovery of a chromosomal abnormality, such as a translocation or inversion, in a person with a single-gene developmental syndrome provides a strong indication of the probable position of the disease locus, because it is likely that one of the breakpoints involved in the rearrangement will have disrupted the relevant gene. However, in a few instances, it has emerged that the chromosome breakpoint actually lies approximately 10 to 1000 kb upstream or downstream of the gene that is subsequently shown to be mutated in other affected individuals (Table 9.8). The probable explanation is that the breakpoint has separated the coding part of the gene from contiguous regulatory elements, similar to the scenario discussed in relation to SHFM type 1 (see Figure 9.2).

### Hydatidiform Moles

Occasionally conception results in an abnormal pregnancy in which the placenta consists of a proliferating disorganized mass known as a hydatidiform mole. These changes can be either partial or complete (Table 9.9).

#### Partial Hydatidiform Mole

Chromosome analysis of tissue from partial moles reveals the presence of 69 chromosomes—i.e., triploidy (p. 238). Using

**Table 9.8** Developmental Genes that Show a Position Effect

Gene	Chromosome	Developmental Anomaly
<i>GLI3</i>	7p13	Greig cephalopolysyndactyly
<i>SHH</i>	7q36	Holoprosencephaly
<i>PAX6</i>	11p13	Aniridia
<i>SOX9</i>	17q24	Campomelic dysplasia

**Table 9.9** Characteristics of Partial and Complete Hydatidiform Moles

	Partial Mole	Complete Mole
No. of chromosomes	69	46
Parental origin of chromosomes	23 maternal 46 paternal	All 46 paternal
Fetus present	Yes, but not viable	No
Malignant potential	Very low	High

DNA polymorphisms, it has been shown that 46 of these chromosomes are always derived from the father, with the remaining 23 being maternal in origin. This doubling of the normal haploid paternal contribution of 23 chromosomes can be due to either fertilization by two sperm, which is known as **dispermy**, or to duplication of a haploid sperm chromosome set by a process known as **endoreduplication**.

In these pregnancies the fetus rarely if ever survives to term. Triploid conceptions survive to term only when the additional chromosome complement is maternally derived, in which case partial hydatidiform changes do not occur. Even in these situations, it is extremely uncommon for a triploid infant to survive for more than a few hours or days after birth.

#### Complete Hydatidiform Mole

Complete moles have only 46 chromosomes, but these are exclusively paternal in origin. A complete mole is caused by fertilization of an empty ovum either by two sperm or by a single sperm that undergoes endoreduplication. The opposite situation of an egg undergoing development without being fertilized by a sperm, a process known as parthenogenesis, occurs in lower animals such as arthropods but has been reported in a human on only one occasion, this being in the form of chimeric fusion with another cell line that had a normal male-derived complement.

The main importance of complete moles lies in their potential to undergo malignant change into invasive choriocarcinoma. This can usually be treated successfully by chemotherapy, but if untreated the outcome can be fatal. Malignant change is seen only very rarely with partial moles.

#### Different Parental Expression in Trophoblast and Embryoblast

Studies in mice have shown that when all nuclear genes in a zygote are derived from the father, the embryo fails to develop, whereas trophoblast development proceeds relatively unimpaired. In contrast, if all of the nuclear genes are maternal in origin, the embryo develops normally, but extra-embryonic development is poor. The observations outlined previously on partial and complete moles indicate that a comparable situation exists in humans, with *paternally* derived genes being essential for trophoblast development and *maternally* derived genes being necessary for early embryonic development. These phenomena are relevant to the concept of epigenetics.

### Epigenetics and Development

The concept of ‘epigenetics’ is not recent. Epigenesis was first mooted as a theme by Conrad Waddington in 1942 and referred, in essence, to the unfolding of developmental programs and processes from an undifferentiated zygote—the very heart of embryonic development. This roughly equates with

our modern understanding of the control of developmental gene expression and signaling pathways. It incorporated the concept of molecular mechanisms being ‘wiped clean’ and ‘reset’ at some point in the life cycle, as mentioned earlier. Although this is still valid, the term in current usage is extended to include heritable changes to gene expression that are *not* from differences in the genetic code. Such gene expression states may be transmitted stably through cell divisions—certainly mitosis but also sometimes meiosis (thereby not necessarily subject to a ‘resetting’ process). One genotype can therefore give rise to more than one phenotype, depending on the ‘epigenetic state’ of a locus, or loci.

The mechanism for epigenesis, and hence DNA modification with the consequence of downstream influences on gene regulation, is usually the biochemical, covalent **methylation** of nucleotides. This appears to lead to a series of steps that alters local chromatin structure. In human genetics the best recognized epigenetic phenomena are X-chromosome inactivation, described below, and parent-of-origin specific gene expression (parental imprinting), which is realized when errors occur to give rise to Prader-Willi and Angelman syndromes (p. 78), and Beckwith-Wiedemann and Russell-Silver syndromes (pp. 79–80).

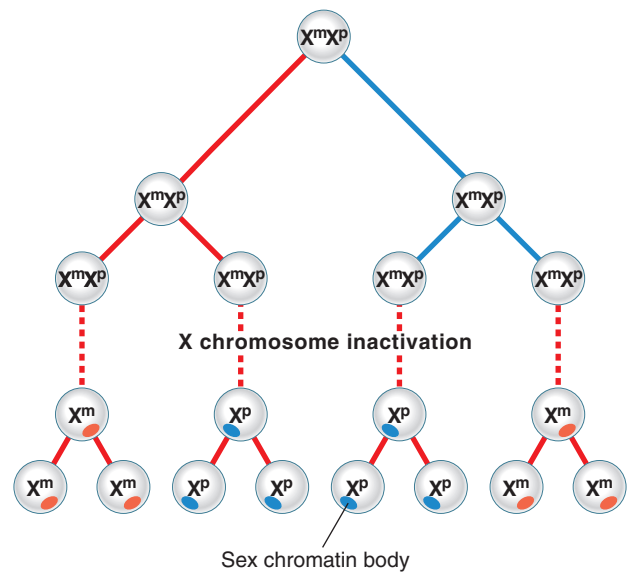
There is much interest, however, in the possibility that epigenetic states can be influenced by environmental factors in utero, such as maternal obesity and type 2 diabetes mellitus, as well as ingested toxins. In animal studies there is evidence that the nutritional and behavioral environment may lead to different ‘epialleles’, and in human populations epidemiological studies have shown convincing correlations of maternal (and in some cases grandparental) nutritional status with late-onset cardiovascular and metabolic-endocrine disease. Some of this evidence has come from correlating peri-conceptional famine exposure, where reliable data exist, to DNA methylation patterns 60 years later. Other studies using banked DNA from birth cohorts have found some correlation between methylation patterns and subsequent body fat composition in later childhood. However, there is still much to learn about the causal mechanisms.

### X-Chromosome Inactivation

As techniques were developed for studying chromosomes, it was noted that in female mice one of the X chromosomes often differed from all other chromosomes in the extent to which it was condensed. In 1961 Dr Mary Lyon proposed that this heteropyknotic X chromosome was inactivated, citing as evidence her observations on the mosaic pattern of skin coloration seen in mice known to be heterozygous for X-linked genes that influence coat color. Subsequent events have confirmed the validity of Lyon’s hypothesis, and in recognition of her foresight the process of X-chromosome inactivation (XCI) is often referred to as **lyonization**.

The process of XCI occurs early in development at approximately 15 to 16 days’ gestation, when the embryo consists of approximately 5000 cells. Normally either of the two X chromosomes can be inactivated in any particular cell. Thereafter, the same X chromosome is inactivated in all daughter cells (Figure 9.27). This differs from marsupials, where the paternally derived X chromosome is consistently inactivated.

The inactive X chromosome exists in a condensed form during interphase when it appears as a darkly staining mass of ‘sex chromatin’, or Barr body (p. 30). In men and women with more than one X chromosome, the number of Barr bodies visible at interphase is always one less than the total number



**FIGURE 9.27** X-chromosome inactivation during development. The maternally and paternally derived X chromosomes are represented as  $X^m$  and  $X^p$ , respectively.

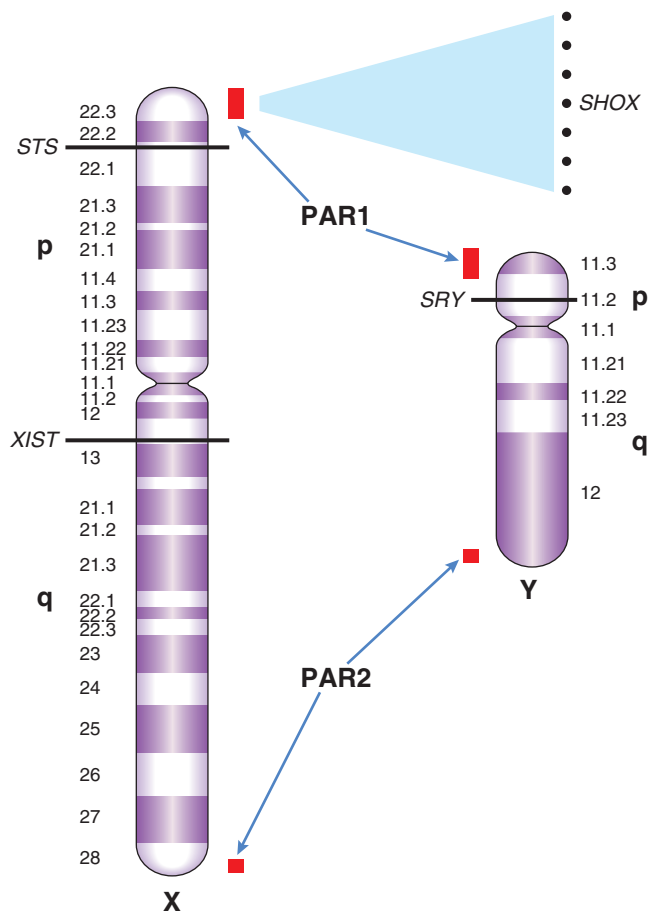
of X chromosomes. Thus, men with Klinefelter syndrome (p. 239) (47,XXY) have a single Barr body, whereas women with a 47,XXX karyotype (p. 241) have two.

During mitosis the inactive X chromosome is late replicating. Laboratory techniques can distinguish which X is late replicating in each cell. This may be useful for identifying structurally abnormal X chromosomes because they are usually preferentially inactivated—or, more correctly, only those hematopoietic stem cells in which the normal X chromosome is active will have survived. Such apparent non-random XCI is usual when one X is involved in a translocation with an autosome (p. 73).

The epigenetic process of XCI is achieved by differential methylation, initiated by a gene called *XIST*, located at Xq13.3. *XIST* is expressed only from the inactive X chromosome and produces RNA that spreads an inactivation methylation signal in both directions along the X chromosome. This differential methylation of the X chromosomes has been utilized in carrier detection studies for X-linked immunodeficiency diseases (e.g., Wiskott-Aldrich syndrome) using methylation-sensitive probes (p. 174). But not all of the X chromosome is inactivated. Genes in the pseudoautosomal region (PAR) at the tip of the short arm (Figure 9.28) remain active, as do other loci elsewhere on both long and short arms, including *XIST*. More genes escape XCI in Xp (PAR1) compared with Xq (PAR2), which probably explains why more severe phenotypic effects are seen in women with small Xp deletions compared with women with small deletions in Xq. If all loci on the X chromosome were inactivated, then all women would have Turner syndrome and more than one X in a male (e.g., 47,XXY), or two in a female (e.g., 47,XXX), would have no phenotypic effects. In fact, these disorders have characteristic clinical features (see Chapter 17).

### Dosage Compensation and X-Linked Disorders Involving the PAR

For most X-chromosome genes the levels of their protein products are equivalent between the sexes by virtue of XCI in women, for example the blood clotting Factor VIII which is implicated in hemophilia A. However, the level of steroid



**FIGURE 9.28** The X and Y chromosomes showing the pseudoautosomal regions, PAR1 and PAR2, at the tips of Xp-Yp and Xq-Yq respectively, and the relative positions of the *XIST*, *SRY*, *STS*, and *SHOX* genes, referred to in the text.

sulfatase in blood, encoded by the *STS* gene, is increased in women compared with men, and this is due to the fact that it escapes XCI and two copies are therefore expressed. Deficiency of steroid sulfatase caused either by a mutation in *STS* or small deletion causes the skin disorder X-linked ichthyosis.

Within the PAR1 itself, the only known gene with a clear role in human development, giving rise to a recognizable phenotype when mutated, is *SHOX* (short stature homeobox; see [Figure 9.28](#)). Mutations in, or deletions of, the gene cause either Leri-Weill dyschondrosteosis with mesomelic limb shortening, or non-syndromic short stature. Deletions may also occur outside the gene itself, affecting the *SHOX* gene regulatory elements. Importantly in genetic counseling, the inheritance pattern behaves like autosomal dominant rather than X-linked.

### X-Chromosome Mosaicism

Mice that are heterozygous for X-linked genes affecting coat color show mosaicism with alternating patches of different color rather than a homogeneous pattern. This is consistent with patches of skin being clonal in origin in that they are derived from a single stem cell in which one or other of the X chromosomes is expressed, but not both. Thus, each patch reflects which of the X chromosomes was active in the original stem cell. Similar effects are seen in tissues of clonal origin in women who are heterozygous for X-linked mutations, such as ocular albinism (see [Figure 11.1](#)) and incontinentia pigmenti (see [Figure 6.18](#), p. 74).

Carrier detection for X-linked recessive disorders based only on examination of clinical features, or on biochemical assay of the gene product in Fabry disease or X-linked adrenoleukodystrophy, for example, is unreliable (see [Chapter 18](#)). Fortunately, the development of molecular methods for carrier detection in X-linked disorders can bypass these problems by use of PCR primers that distinguish the products of methylated and unmethylated DNA—if there has been selection against the cell line in which the mutant-bearing X chromosome is active ([Figure 9.29](#)). Some female carriers of X-linked recessive conditions manifest clear features of the disorder, and this is most likely to be due to *skewed* X-inactivation (p. 122).

It also appears that XCI is not necessarily an all-or-none phenomenon for every gene. In a study of skin fibroblasts, which express more than 600 of the 1098 genes identified on the X chromosome, approximately 20% were found to be inactivated in some but not all samples. Approximately 15% escaped XCI completely, whereas only 65% were fully silenced and thus expressed in one dose. In addition to non-random, or skewed, XCI, the variable dosage of genes that escape XCI may account for variation among normal females as well as those who are heterozygous for X-linked recessive disease genes.

## Sex Determination and Disorders of Sex Development

The determination of gender is a crucial aspect of *physical* development, as well as procreation and the survival of our species, but when it goes wrong the impact may be extremely challenging for the parents and family as well as the affected child, with lifelong *emotional* and *psychological* consequences. In many societies serious *cultural taboos* are associated with the birth of a child whose gender is indeterminate. The term Disorders of Sex Development (DSD) is now preferred to cover congenital conditions in which chromosomal, gonadal, or anatomical sex is atypical, and terms such as ‘inter-sex’ and ‘pseudohermaphrodite’ are considered anachronistic and derogatory, and are therefore strongly discouraged. In a clinical setting, good management of each case requires expert input from the disciplines of endocrinology, genetics, surgery, and psychology, as well as radiology and laboratory science.

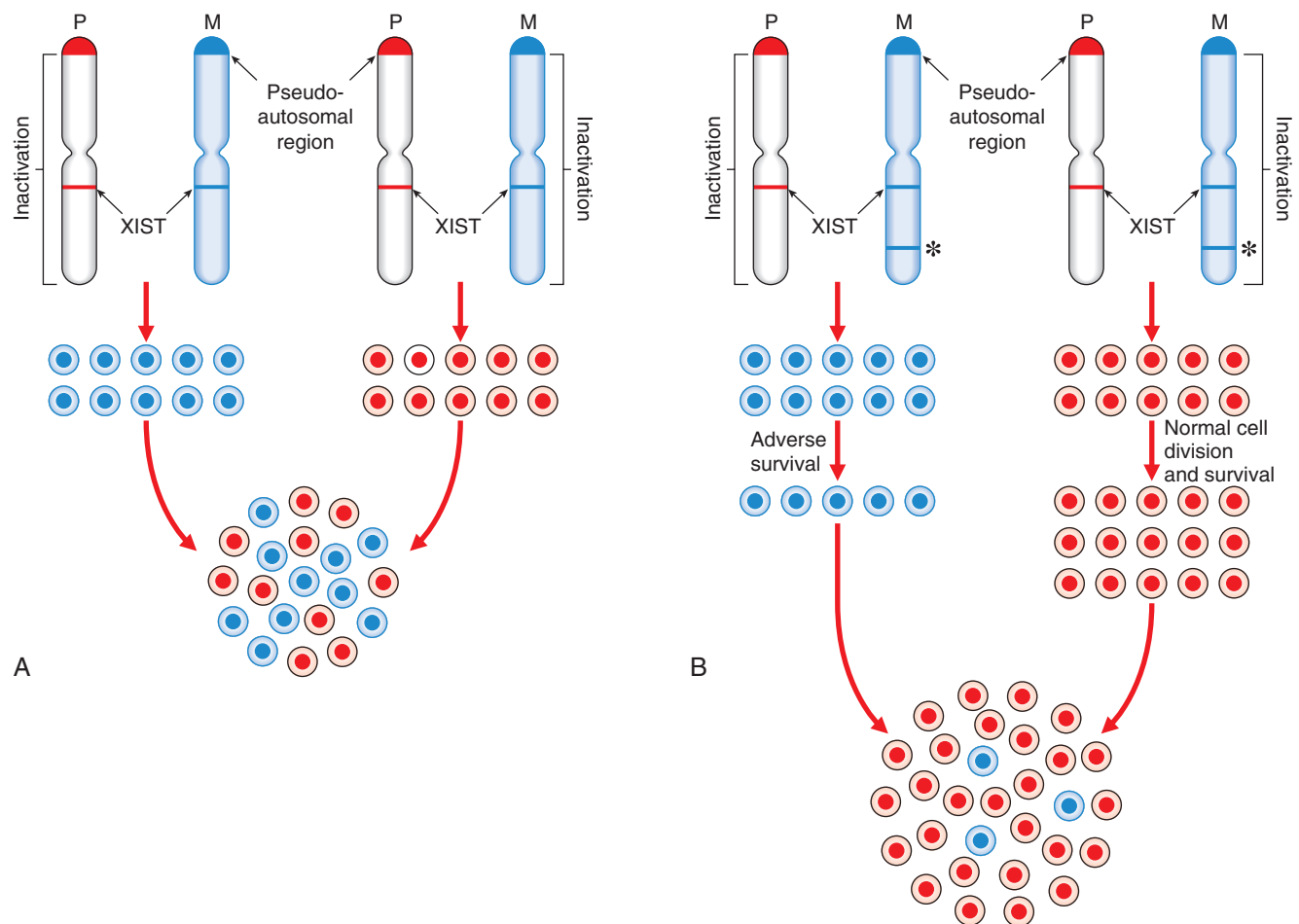
### Normal Development

In man the default developmental pathway is, in fact, woman! The presence of an intact Y chromosome is essential for male development regardless of the number of X chromosomes present, and absence of a functioning Y chromosome results in female development.

Although the sex chromosomes are present from conception, differentiation into a phenotypic male or female does not commence until approximately 6 weeks. Up to this point both the Müllerian and Wolffian duct systems are present and the embryonic gonads, although consisting of cortex and medulla, are still undifferentiated ([Figure 9.30](#)). From 6 weeks onwards, the embryo develops into a female unless the ‘testis-determining factor’—the *SRY* gene—initiates a sequence of events that prompt the undifferentiated gonads to develop into testes ([Figure 9.31](#)).

### The *SRY* Gene

In 1990 it was shown that the *SRY* gene is located on chromosome Yp close to the pseudoautosomal region (see [Figure 9.28](#)), and derives its name from being in the ‘Sex-determining



**FIGURE 9.29** **A**, Normal X-chromosome inactivation resulting in survival of roughly equal numbers of cells with the paternally (P) and maternally (M) derived X chromosome active. **B**, In this situation the maternally derived X chromosome has a mutation (\*) that results in selection against the cells in which it is active. Thus surviving cells show preferential expression of the paternally derived X chromosome.

Region' of the Y chromosome. It consists of a single exon that encodes a protein of 204 amino acids, including a 79-amino-acid DNA-binding HMG motif (p. 109), indicating its role as a transcription factor. Evidence that the *SRY* gene determines gonadal and anatomic (but not necessarily chromosomal) maleness is given in [Box 9.2](#).

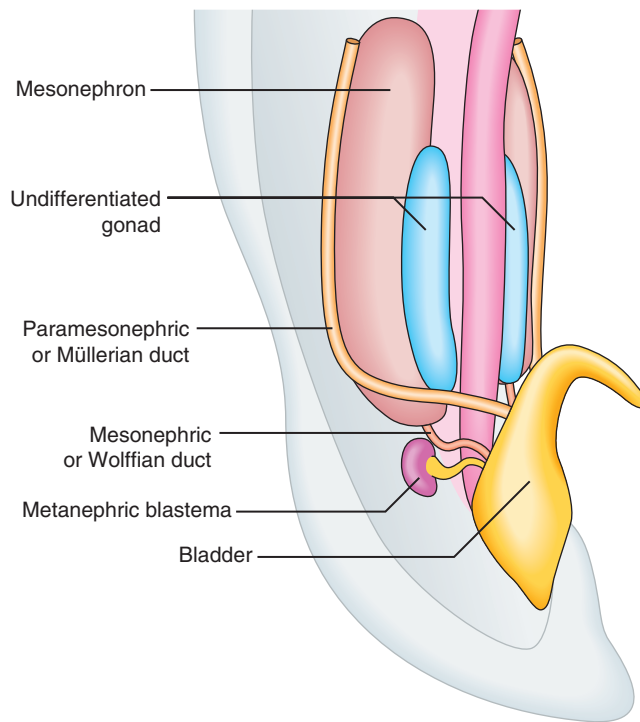
From a biological fitness viewpoint (i.e., the maintenance of the species), it would clearly be impossible for the *SRY* gene to be involved in crossing over with the X chromosome during meiosis I. Hence *SRY* has to lie outside the pseudoautosomal region. However, there has to be pairing of X and Y

chromosomes, as otherwise they would segregate together into the same gamete during, on average, 50% of meioses. Nature's compromise has been to ensure that only small regions of the X and Y are homologous, and therefore pair during meiosis I. Unfortunately, the close proximity of *SRY* to the pseudoautosomal region means that occasionally it is caught up in a recombination event (see [Figure 9.28](#)). This appears to account for approximately 80% of XX males, in whom molecular and FISH studies show evidence of Y-chromosome sequences at the distal end of one X-chromosome short arm ([Figure 9.32](#)).

Expression of *SRY* triggers a series of events that involves inhibition of an upstream repressor of *SOX9* (17q24), allowing the latter to be upregulated to stimulate the medulla of the undifferentiated gonad to develop into a testis and for pre-Sertoli cells to become Sertoli cells. Concomitantly, and by the end of week 9, interstitial cells derived from mesenchyme give rise to steroid-secreting Leydig cells and the production of testosterone ([Figure 9.33](#)). This leads to stimulation of the Wolffian ducts and formation of male internal genitalia, as well as masculinization of the external genitalia. This latter step is mediated by dihydrotestosterone, produced from testosterone by the action of  $5\alpha$ -reductase (p. 262). The Sertoli cells produce anti-Müllerian hormone, also known as Müllerian inhibitory factor, which causes the Müllerian duct system to regress. In campomelic dysplasia (see [Figure 9.16](#)), resulting

### Box 9.2 Evidence that the *SRY* Gene Determines Gonadal and Anatomic Maleness

- *SRY* sequences are present in approximately 80% of 46,XX individuals, who are infertile phenotypic males.
- Up to 20% of infertile, phenotypic females with a 46,XY karyotype have mutations or deletions in *SRY*.
- In mice, the *Sry* gene is expressed only in the male gonadal ridge as testes are developing in the embryo.
- Transgenic XX mice with tiny portions of Y chromosome containing the *Sry* region develop into males with testes.



**FIGURE 9.30** Both male and female genital ducts are present in the embryo at the end of 6 weeks' gestation, derived from the mesonephrons. Anatomical sex has the potential to differentiate either way.

from mutated *SOX9*, sex reversal occurs in cases with a 46,XY karyotype. Sex reversal is also frequent in cases of deletion 9p24.3 syndrome, probably due to haploinsufficiency for the *DMRT1* gene, a transcriptional regulator expressed in Sertoli cells, spermatogonia, and spermatocytes.

In the absence of normal *SRY* expression, the cortex of the undifferentiated gonad develops into an ovary. The Müllerian duct forms the internal female genitalia. The external genitalia fail to fuse and grow as in the male, and instead evolve into normal female external genitalia. Without the stimulating effects of testosterone, the Wolffian duct system regresses.

Members of the Wnt family of developmental signaling molecules are also important in gonadal differentiation. *WNT4* is expressed in the developing mesonephros and activates

**Table 9.10** Nomenclature Relating to Disorders of Sex Development (DSDs)

Previous	Proposed
Intersex	Disorders of sex development (DSDs)
Male pseudohermaphrodite	46,XY DSD
Undervirilization of an XY male	
Female pseudohermaphrodite	46,XX DSD
Overvirilization of an XX female	
Masculinization of an XX female	
True hermaphrodite	Ovotesticular DSD
XX male or XX sex reversal	46,XX testicular DSD
XY sex reversal	46,XY complete gonadal dysgenesis

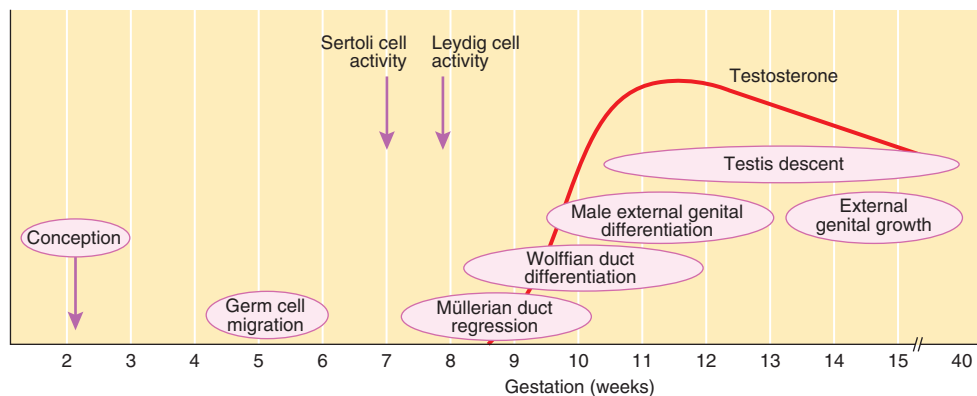
*DAX1*. It is down-regulated in the testis by *SRY* but persists in the ovary, is expressed in the Müllerian ducts but is absent from Wolffian ducts. Disruption of *WNT4* in females results in masculinized ovaries, production of androgens from Leydig-like cells, and is a rare cause of Müllerian aplasia. Another member of the family, *WNT7A*, is needed to complete development of Müllerian ducts into the internal female genital tract.

Normally sexual differentiation is complete by 12 to 14 weeks' gestation, although the testes do not migrate into the scrotum until late pregnancy (see [Figure 9.31](#)).

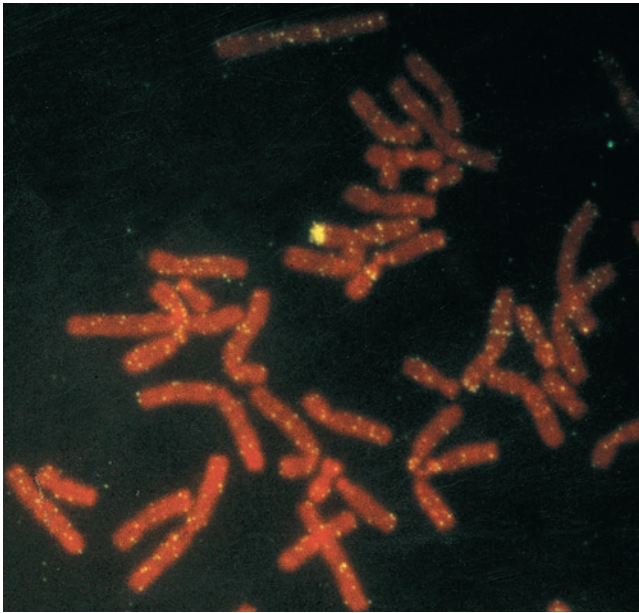
Abnormalities of sexual differentiation are uncommon but they are important causes of infertility and sexual ambiguity, and their management involves multidisciplinary teams. We now turn our attention to an overview of the various DSDs, though sex chromosome aneuploidy conditions are described in [Chapter 17](#), and congenital adrenal hyperplasia (CAH) is covered in [Chapter 18](#).

### Classification of DSDs

This is a complex area and dissatisfaction with existing classifications led to a major multidisciplinary and far-ranging international review of DSDs, with the establishment of a new system known as the Chicago Consensus, published in 2006. However, this remains a 'work in progress' as a definitive diagnosis is not always reached and there is more to be discovered in the molecular pathways of sexual differentiation. The main proposals for changes in nomenclature are shown in [Table 9.10](#). Apart from the sex chromosome aneuploidies



**FIGURE 9.31** The timing of embryological events in male sex differentiation. At approximately 6–7 weeks' gestation the first sign of testis determination is seen with the aggregation of pre-Sertoli cells to form primary sex cords. Steroid-secreting Leydig cells emerge from differentiation of interstitial cells by the end of week 9, which secrete anti-Müllerian hormone (AMH) to cause Müllerian duct regression. Testosterone levels rise in fetal serum to approach concentrations close to the lower end of the adult male range.



**FIGURE 9.32** FISH showing hybridization of a Y chromosome paint to the short arm of an X chromosome in a 46,XX male. (Courtesy Nigel Smith, City Hospital, Nottingham, UK.)

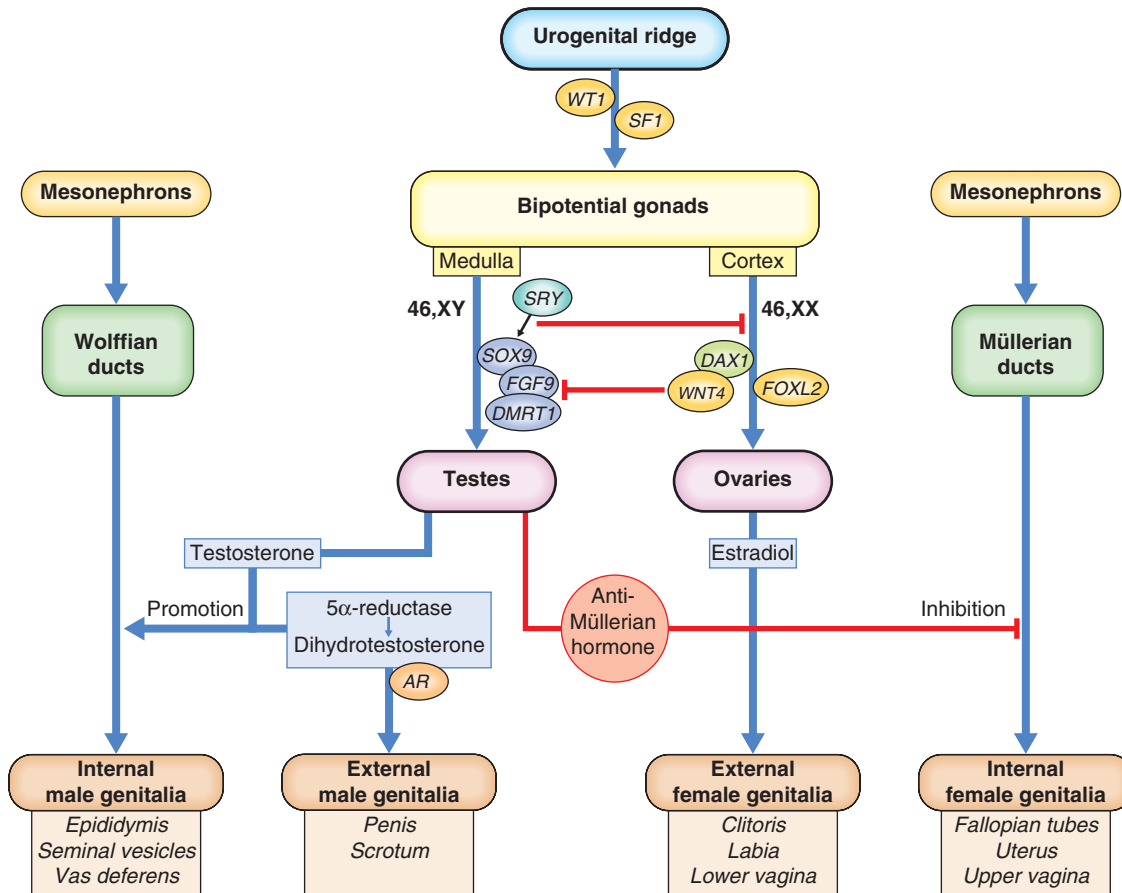
(Chapter 17) the starting point for the classification is the chromosomal sex, and an outline diagnostic tree or algorithm is shown in Figure 9.34.

**46,XY DSDs**

In the current classification the causes of XY DSDs are shown in Box 9.3. This is the largest group of DSDs but the likelihood of reaching a definitive genetic diagnosis is lower than the XX DSD group. No more than 15% of cases of complete gonadal dysgenesis are due to *SRY* gene defects, so other genes are implicated, including *SF1*, also known as *NR5A1*, which encodes the protein steroidogenic factor 1. Some are implicated in various syndromes, such as *SOX9* in campomelic dysplasia (see Figure 9.16).

*Androgen Insensitivity Syndrome*

Overall, resistance to the action of androgens is the most common cause of XY DSD, with complete androgen insensitivity syndrome (CAIS) being the classic condition. This is usually due to mutations in the androgen receptor (*AR*) gene on the X-chromosome but can be secondary to abnormalities of *AR* intracellular transport, which is dependent on a number of coregulator proteins. Partial AIS (PAIS), where partial under-masculinization occurs, is only occasionally due to variants in the *AR* gene and in many cases the cause currently remains undetermined. Individuals with CAIS have female external



**FIGURE 9.33** A simplified scheme of the main genetic and hormonal events of sex determination. *SRY* is crucial to driving testis development, whereas *WNT4* and *FOXL2* are important for ovarian development. The promotion of either male or female gonads is accompanied by inhibition of the pathways in the alternative gonad. *DAX1* has a positive role in testis development but overexpression inhibits testis formation, and *WNT4* upregulates *DAX1* to assist this inhibition.



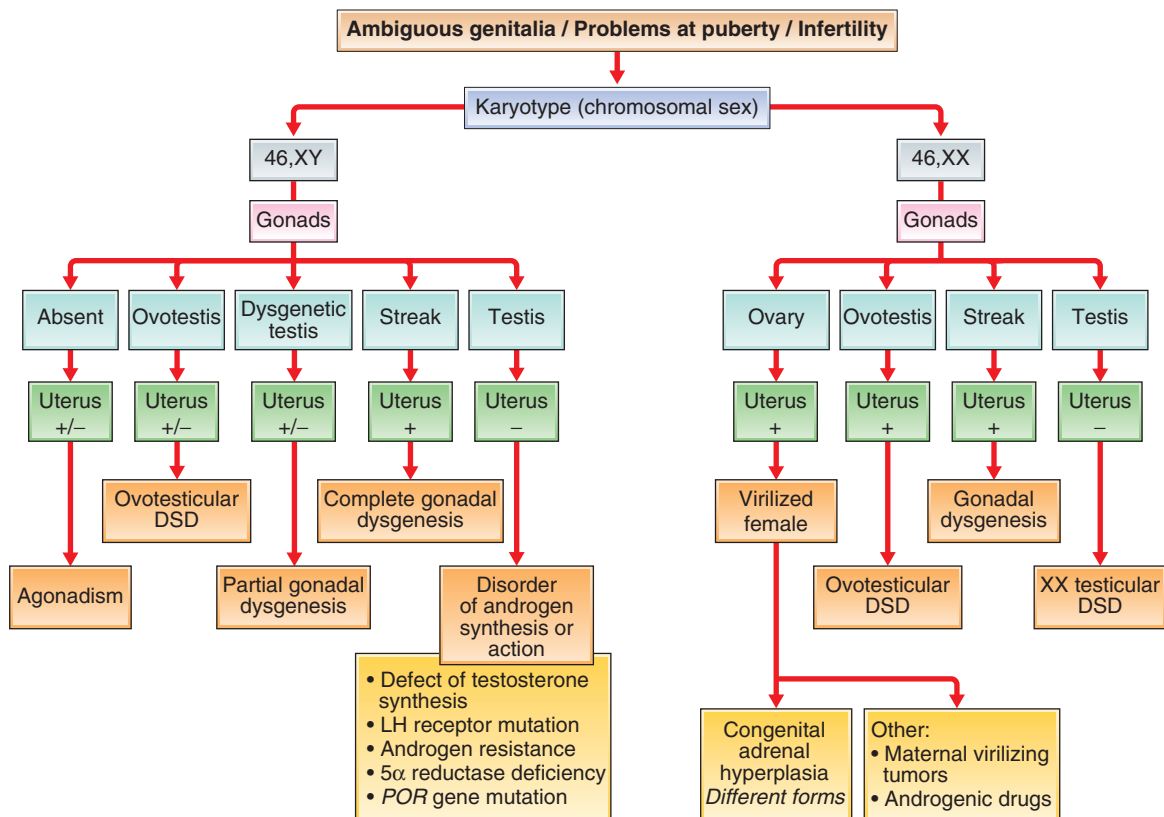


FIGURE 9.34 A DSD diagnostic tree or algorithm.

### Box 9.3 Causes of 46,XY DSDs

#### A: Disorders of gonadal (testicular) development

1. Complete or partial gonadal dysgenesis (e.g. *SRY*, *SOX9*, *SF1*, *WT1*, *DHH* etc.)
2. Ovotesticular DSD
3. Testis regression

#### B: Disorders in androgen synthesis or action

##### 1. Disorders of androgen synthesis

- LH receptor mutations
- Smith-Lemli-Opitz syndrome
- Steroidogenic acute regulatory protein mutations
- Cholesterol side-chain cleavage (*CYP11A1*)
- 3 $\beta$ -hydroxysteroid dehydrogenase 2 (*HSD3B2*)
- 17 $\alpha$ -hydroxylase/17,20-lyase (*CYP17*)
- P450 oxidoreductase (*POR*)
- 17 $\beta$ -hydroxysteroid dehydrogenase (*HSD17B3*)
- 5 $\alpha$ -reductase 2 (*SRD5A2*)

##### 2. Disorders of androgen action

- Androgen insensitivity syndrome (*AR* gene)
- Drugs and environmental modulators

#### C: Other

1. Syndromic associations of male genital development, e.g. cloacal anomalies
2. Persistent Müllerian duct syndrome
3. Vanishing testis syndrome
4. Isolated hypospadias (*CXorf6*)
5. Congenital hypogonadotropic hypogonadism
6. Cryptorchidism (*INSL3*, *LGR8*)
7. Environmental influences

genitalia and develop breasts at puberty, but the uterus and fallopian tubes are absent. They often present with primary amenorrhoea, though in girls with inguinal hernia, especially if bilateral, the diagnosis should be considered. Androgen production by the testes is normal but it does not bind because the receptor is non-functional. Testicular tissue must be removed because of the risk of malignancy.

### 46,XX DSDs

The causes of XX DSDs are shown in Box 9.4. Congenital adrenal hyperplasia is the most common form of XX DSD, due to defects in steroidogenesis leading to excess androgens in the developing female fetus. This is covered in detail in Chapter 18 (p. 261). Relatively recently identified conditions in this group are those cases due to mutations in the cytochrome P450 oxidoreductase (*POR*) gene (which is also implicated in some cases of the rare Antley-Bixler syndrome) and aromatase deficiency.

A normal male phenotype occurs in 46,XX DSD where Wolffian structures (testes) are present and Müllerian structures absent, and these patients are often diagnosed when a karyotype analysis is undertaken for infertility. Approximately 80% to 90% of these patients have Y chromosomal material, including a translocated *SRY* gene, which is only rarely detected in 46,XX DSD where testicular structures (and sometimes ovarian structures – ‘ovotestis’) are present. Such ‘dysgenetic’ gonads are often at risk of later gonadoblastoma and in many DSDs prophylactic gonadectomy is recommended when this tissue has been located.

### Twinning

Twinning occurs frequently in humans, although the incidence in early pregnancy as diagnosed by ultrasonography is greater

**Box 9.4 Causes of 46,XX DSDs****A: Disorders of gonadal (ovarian) development**

1. Gonadal dysgenesis
2. Ovotesticular DSD
3. Testicular DSD (e.g. *SRYp*, dup *SOX9*, *RSP01*)

**B: Androgen excess****1. Fetal (different forms of congenital adrenal hyperplasia)**

- 3 $\beta$ -hydroxysteroid dehydrogenase 2 (*HSD3B2*)
- 21-hydroxylase (*CYP21A2*)
- P450 oxidoreductase (*POR*)
- 11 $\beta$ -hydroxylase (*CYP11B1*)
- Glucocorticoid receptor mutations

**2. Fetoplacental**

- Aromatase (*CYP19*) deficiency
- Oxidoreductase (*POR*) deficiency

**3. Maternal**

- Maternal virilizing tumors (e.g. luteomas)
- Androgenic drugs

**C: Other**

1. Syndromic associations (e.g. cloacal anomalies)
2. Müllerian agenesis/hypoplasia, (e.g. MURCS)
3. Uterine abnormalities (e.g. *MODY5—HNF1B* gene)
4. Vaginal atresias (e.g. KcKusick-Kaufman)
5. Labial adhesions

than at delivery, presumably as a result of death and subsequent resorption of one of the twins in a proportion of twin pregnancies. The overall incidence of twinning in the UK is approximately 1 in 80 of all pregnancies, so that approximately 1 in 40 (i.e., 2 of 80) of all individuals is a twin. However, the spontaneous twinning rate varies enormously, from approximately 1 in 125 pregnancies in Japan to 1 in 22 in Nigeria.

Twins can be identical or non-identical—i.e., **monozygotic** (MZ) (uniovular) or **dizygotic** (DZ) (biovular)—depending on whether they originate from a single conception or from two separate conceptions (Table 9.11). Comparison of the incidence of disease in MZ and DZ twins reared apart and together can provide information about the relative contributions of genetics

and the environment to the cause of many of the common diseases of adult life (p. 131), especially the study of mental health and behavior.

**Monozygotic Twins**

MZ twinning occurs in approximately 1 in 300 births in all populations that have been studied. MZ twins originate from a single egg that has been fertilized by a single sperm. A very early division, occurring in the zygote before separation of the cells that make the chorion, results in dichorionic twins. Division during the blastocyst stage from days 3 to 7 results in monochorionic diamniotic twins. Division after the first week leads to monoamniotic twins. However, the reason(s) why MZ twinning occurs at all in humans is not clear. As an event, the incidence is increased two- to five-fold in babies born by *in vitro* fertilization. There are rare cases of familial MZ twinning that can be transmitted by the father or mother, suggesting a single-gene defect that predisposes to the phenomenon.

There is a tendency to think of MZ twins as being genetically identical, and basically this is of course true. However, they can be discordant for structural birth defects that may be linked to the twinning process itself—especially those anomalies affecting midline structures. There is probably a two- to three-fold increased risk of congenital anomalies in MZ twins (i.e., 5% to 10% of MZ twins overall). Discordance for single-gene traits or chromosome abnormalities may occur because of a post-zygotic somatic mutation or non-disjunction, respectively. One example of the latter is the very rare occurrence of MZ twins of different sex: one 46,XY and the other 45,X. Curiously, MZ female twins can show quite striking discrepancy in X-chromosome inactivation. There are several reports of female MZ twin pairs of which only one is affected by an X-linked recessive condition such as DMD or hemophilia A. In these rare examples, both twins have the mutation and both show non-random X-inactivation, but in opposite directions.

MZ twins have traditionally provided ideal research material for the study of genetic versus environmental influences. In a study of 40 pairs of MZ twins, geneticists measured levels of two epigenetic modifications, DNA methylation, and histone acetylation. Two-thirds of the twin pairs had essentially identical profiles, but significant differences were observed in the remaining third. These differences were broadly correlated with the age of the twins, with the amount of time spent apart and the differences in their medical histories, suggesting a cumulative effect on DNA modification over time. It also suggests a possible causal link between epigenetic modification and susceptibility to disease.

Very late division occurring more than 14 days after conception can result in conjoined twins. This occurs in about 1 in 100,000 pregnancies, or approximately 1 in 400 MZ twin births. Conjoined twins are sometimes referred to as Siamese, in memory of Chang and Eng, who were born in 1811 in Thailand, then known as Siam. They were joined at the upper abdomen and made a successful living as celebrities at traveling shows in the United States, where they settled and married. They both managed to have large numbers of children and died within a few hours of each other at age 61.

The sex ratio for conjoined twins is markedly distorted, with approximately 75% being female. The later the twinning event, the more distorted the sex ratio in favor of females, and X-inactivation studies suggest that MZ twinning occurs around the time of X-inactivation, a phenomenon limited to female zygotes, of course.

**Table 9.11** Summary of Differences Between Monozygotic and Dizygotic Twins

	Monozygotic	Dizygotic
Origin	Single egg fertilized	Two eggs, each fertilized by a single sperm
Incidence	1 in 300 pregnancies	Varies from 1 in 100 to 1 in 500 pregnancies
Proportion of genes in common	100%	50% (on average)
Fetal membranes	70% monochorionic and diamniotic; 30% dichorionic and diamniotic; rarely monochorionic and monoamniotic	Always dichorionic and diamniotic

## Dizygotic Twins

DZ twins result from the fertilization of two ova by two sperm and are no more closely related genetically than brothers and sisters, as they share, on average, 50% of the same genes from each parent; hence, they are sometimes referred to as **fraternal twins**. DZ twins are dichorionic and diamniotic, although they can have a single fused placenta if implantation occurs at closely adjacent sites. The incidence varies from approximately 1 in 100 deliveries in black Caribbean populations to 1 in 500 deliveries in Asia and Japan. In western European whites, the incidence is approximately 1 in 120 deliveries and has been observed to fall with both urbanization and starvation, but increases in relation to the amount of seasonal light (e.g., in northern Scandinavia during the summer). Factors that convey an increased risk for DZ twinning are: increased maternal age, a positive family history (from a familial increase in follicle-stimulating hormone levels), and the use of ovulation-inducing drugs such as clomiphene.

## Determination of Zygosity

Zygosity used to be established by study of the placenta and membranes and also by analysis of polymorphic systems such as the blood groups, the human leukocyte antigens and other biochemical markers. Now it is determined most reliably by the use of highly polymorphic molecular (DNA) markers (pp. 50–52) and single nucleotide polymorphisms.

## FURTHER READING

- Baker, K., Beales, P.L., 2009. Making sense of cilia in disease: the human ciliopathies. *Am. J. Med. Genet.* 151C, 281–295.
- Dequéant, M.-L., Pourquié, O., 2008. Segmental patterning of the vertebrate embryonic axis. *Nat. Rev. Genet.* 9, 370–382.
- Gibb, S., Maroto, M., Dale, J.K., 2010. The segmentation clock mechanism moves up a notch. *Trends Cell Biol.* 20, 593–600.  
*An overview of Notch signaling.*
- Hall, J.G., 2003. Twinning. *Lancet* 362, 735–743.
- Hughes, I.A., 2008. Disorders of sex development: a new definition and classification. *Best Pract. Res. Clin. Endocrinol. Metab.* 22, 119–134.
- Krumlauf, R., 1994. Hox genes in vertebrate development. *Cell* 78, 191–201.  
*An early overview of Hox genes.*
- Lyon, M.F., 1961. Gene action in the X chromosome of the mouse (*Mus musculus* L). *Nature* 190, 372–373.  
*The original proposal of X-inactivation—very short and easily understood.*
- Muragaki, Y., Mundlos, S., Upton, J., Olsen, B.R., 1996. Altered growth and branching patterns in synpolydactyly caused by mutations in HOXD13. *Science* 272, 548–551.  
*The long-awaited first report of a human malformation caused by a mutation in a HOX gene.*
- Passos-Bueno, M.R., Ornelas, C.C., Fanganiello, R.D., 2009. Syndromes of the first and second pharyngeal arches: a review. *Am. J. Med. Genet. A* 149A, 1853–1859.  
*An excellent short overview of pharyngeal arches and associated syndromes.*
- Saga, Y., 2012. The mechanism of somite formation in mice. *Curr. Opin. Genet. Dev.* 22, 331–338.  
*An excellent review of somite development.*

Tickle, C., 2003. Patterning in vertebrate development. Oxford University Press, Oxford.

*A detailed, multi-author collection handling very early development, from mainly molecular perspectives.*

Villavicencio, E.H., Walterhouse, D.O., Iannaccone, P.M., 2000. The Sonic hedgehog-patched-Gli pathway in human development and disease. *Am. J. Hum. Genet.* 67, 1047–1054.

*An excellent short overview of the Sonic hedgehog pathway.*

## ELEMENTS

- 1 Developmental gene families first identified in *Drosophila* and mice also play important roles in human morphogenesis. These include segment polarity genes, homeobox-containing genes (*HOX*) and paired-box containing genes (*PAX*). Many of these genes act as transcription factors that regulate sequential developmental processes. Others are important in cell signaling. Many human malformations and multiple malformation syndromes are caused by mutations in these genes.
- 2 Many well-recognized syndromes are now known to be linked through their relationships to developmental signaling pathways (e.g., Sonic-Hedgehog, Notch-Delta, TGF-Beta).
- 3 The conformational alignment and relationship of a developmental gene with its promotor, enhancer or repressor is key to normal developmental processes, particularly in the limb bud.
- 4 For normal development a haploid chromosome set must be inherited from each parent. A paternal diploid complement results in a complete hydatidiform mole if there is no maternal contribution, and in triploidy with a partial hydatidiform mole if there is a haploid maternal contribution.
- 5 The testis-determining factor on the Y chromosome, known as *SRY*, is crucial in stimulating the undifferentiated gonads to develop into testes. This, in turn, sets off a series of events leading to male development and suppression of female gonadal development. Without *SRY* expression the human embryo develops into a female.
- 6 In females one of the X chromosomes is inactivated in each cell in early embryogenesis. This can be either the maternally derived or the paternally derived X chromosome. Thereafter, in all daughter cells the same X chromosome is inactivated. This process, known as lyonization, explains the presence of the Barr body in female nuclei and achieves dosage compensation of X-chromosome gene products in males and females.
- 7 Twins can be monozygotic (identical) or dizygotic (fraternal). Monozygotic twins originate from a single zygote that divides into two during the first 2 weeks after conception. Monozygotic twins are genetically identical. Dizygotic twins originate from two separate zygotes and are no more genetically alike than brothers and sisters.

# Common Disease, Polygenic and Multifactorial Genetics

Many disorders demonstrate familial clustering that does not conform to any recognized pattern of Mendelian inheritance. Examples include several of the most common congenital malformations and many common acquired diseases (Box 10.1). These conditions show a definite familial tendency, but the incidence in close relatives of affected individuals is much lower than would be seen if these conditions were caused by mutations in single genes. Medical genetics usually concentrates on the study of rare unifactorial chromosomal and single-gene disorders. Diseases such as diabetes, cancer, cardiovascular and coronary artery disease, mental health, and neurodegenerative disorders are responsible, however, for the majority of the morbidity and mortality in developed countries.

Because it is likely that many factors, both genetic and environmental, are involved in causing these disorders, they are generally referred to as showing **multifactorial** inheritance, although sometimes one can appear more important than the other (Figure 10.1). At one extreme are diseases such as Duchenne muscular dystrophy; these are exclusively genetic in origin, and the environment plays little or no direct part in the etiology. At the other extreme are infectious diseases that are

almost entirely the result of environmental factors. Between these two extremes are the common diseases and disorders such as diabetes mellitus, hypertension, cerebrovascular and coronary artery disease, schizophrenia, the common cancers, and certain congenital abnormalities in which both genetic and environmental factors are involved.

## Types and Mechanisms of Genetic Susceptibility

Genetic susceptibility for a particular disease can occur through single-gene inheritance of an abnormal gene product involved in a particular metabolic pathway, such as occurs in early coronary artery disease arising from familial hypercholesterolemia (FH) (p. 262). In an individual with a mutation in the *FH* gene, the genetic susceptibility is the main determinant of the development of coronary artery disease, but this can be modified by environmental alteration like reduction in dietary cholesterol and avoidance of other risk factors such as obesity, lack of exercise, and smoking.

Inheritance of single-gene susceptibility does not, however, necessarily lead to development of a disease. For some diseases, exposure to specific environmental factors will be the main determinant in the development of the disease (e.g., smoking or occupational dust exposure in the development of pulmonary emphysema in persons with  $\alpha_1$ -antitrypsin deficiency [p. 288]).

In other instances, the mechanism of the genetic susceptibility is less clear-cut. This can involve inheritance of a single gene polymorphism (p. 50) that leads to differences in susceptibility to a disease (e.g., acetaldehyde dehydrogenase activity and alcoholism). In addition, inherited single-gene polymorphisms appear to determine the response to as yet undefined environmental factors—for example, the antigens of the major histocompatibility (HLA) complex and specific disease associations (p. 170) such as type 1 diabetes and rheumatoid arthritis. Lastly, genetic susceptibility can determine differences in responses to medical treatment; isoniazid inactivation status in the treatment of tuberculosis (p. 201) is a good example.

Many common diseases however are **polygenic**, being determined by variation in many genes at different loci, with each variant exerting a small, generally **additive** effect. Additive means that the influence of each genetic variant on the phenotype is cumulative, not dominant or recessive. For instance if a variant doubles the risk for coronary heart disease, compared with homozygous carriers of the low-risk allele, heterozygotes will have a twofold increased risk and alternative homozygotes a fourfold increased risk of heart disease.

### Box 10.1 Disorders That Show Multifactorial Inheritance

#### Congenital Malformations

Cleft lip/palate  
Congenital dislocation of the hip  
Congenital heart defects  
Neural tube defects  
Pyloric stenosis  
Talipes

#### Acquired Diseases of Childhood and Adult Life

Asthma  
Autism  
Diabetes mellitus  
Epilepsy  
Glaucoma  
Hypertension  
Inflammatory bowel disease (Crohn disease and ulcerative colitis)  
Ischemic heart disease  
Ischemic stroke  
Bipolar disorder  
Multiple sclerosis  
Parkinson disease  
Psoriasis  
Rheumatoid arthritis  
Schizophrenia

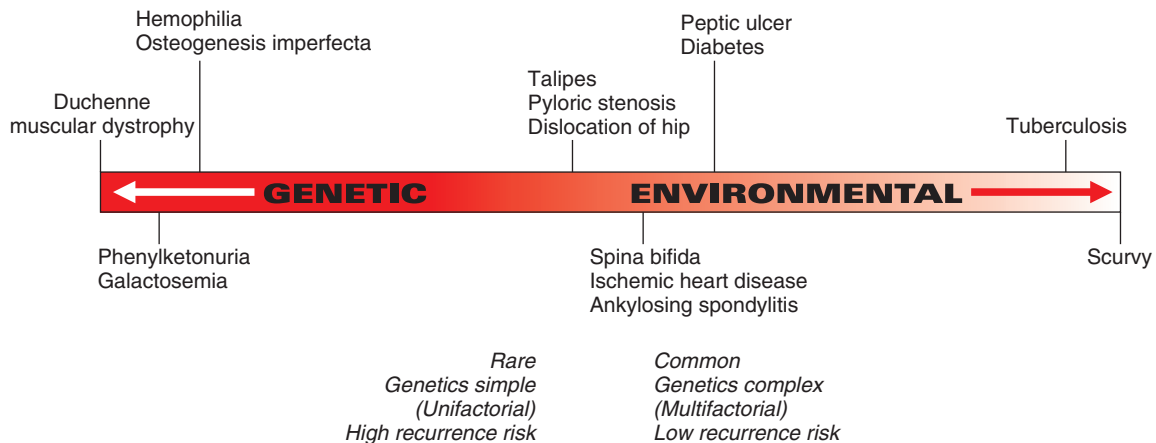


FIGURE 10.1 Human diseases represented as being on a spectrum ranging from those that are largely environmental in causation to those that are entirely genetic.

## Approaches to Demonstrating Genetic Susceptibility to Common Diseases

In attempting to understand the genetics of a particular condition, the investigator can approach the problem in a number of ways. These can include comparing the prevalence and incidence in various different population groups and the effects of migration. Studies of migrant groups moving from a population group with a low incidence of a disease to one with a high incidence, in which the incidence of the disease in the migrant group rises to that of its new population group, would suggest that environmental factors are more important. Conversely, maintenance of a low incidence of the disease in the migrant group would suggest that genetic factors are more important.

### Family and Twin Studies

Genetic susceptibility to a disease can be suggested by the finding of a higher frequency of the disease in relatives than in the general population. Familial aggregation does not, however, prove a genetic susceptibility, since families share a common environment. This problem can be partly resolved by comparing differences in the frequency of a disease or disorder between non-identical or dizygotic (DZ) and identical or monozygotic (MZ) twin pairs. Both members of a pair of twins are said to be **concordant** when either both are affected or neither is affected. The term **discordant** is used when only one member of a pair of twins is affected. Both types of twins will have a tendency to share the same environment but, whereas identical twins basically have identical genotypes (p. 127), non-identical twins are no more similar genetically than brothers and sisters. If a disease is entirely genetically determined, then apart from rare events such as chromosome non-disjunction or a new mutation occurring in one of a twin pair, both members of a pair of identical twins will be similarly affected, but non-identical twins are more likely to differ. If a disease is entirely caused by environmental factors, then identical and non-identical twins will have similar concordance rates.

Although all twins tend to share the same environment, it is probably more likely in identical twins than in non-identical twins. Similarities between identical twins can therefore reflect their shared environment as much as their identical genotypes. In one study of identical twins reared separately, the data clearly showed that each pair of twins differed little in height

but differed considerably in body weight. These observations suggest that heredity plays a bigger part in determining stature than it does in determining body weight.

### Heritability

The similarity between individuals in a family for a particular phenotype can be used to calculate the heritability of the disease or trait. The heritability gives a mathematical estimate of the relative contributions of genetic variation and environmental factors to the trait variability. Heritability (often denoted  $h^2$ ) is the proportion of a trait that is due to genetic variation divided by the total variation in the trait in a given population. The total variation is a combination of genetic and environmental variation. Genetic variability is best calculated by measuring the difference in disease concordance in identical twins compared with non-identical twins, who only share 50% of their genes on average, but like identical twins have a shared environment. The calculation assumes that environmental variation for twin pairs is identical, which may not be true, and may differ for MZ versus DZ twins. A more accurate estimate can be achieved by comparing twin pairs separated at birth, but these studies are not feasible for most diseases because there are not enough individuals that meet these criteria. Where such studies have been carried out they give estimates comparable to the MZ versus DZ comparisons. Heritability estimates for some common multifactorial diseases are given in Table 10.1.

The degree of familial clustering shown by a multifactorial disorder can be estimated by measuring the ratio of the risk to siblings of affected individuals compared with the general population incidence. This ratio of sib risk to population incidence is known as  $\lambda_s$ . For example, in type 1 diabetes, where the UK population incidence is 0.4% and the risk to siblings is 6%,  $\lambda_s$  is 15. For type 2 diabetes in Europe,  $\lambda_s$  is estimated at a more modest 3.5 (35% sibling risk; 10% population risk).

### Polymorphism Association Studies

Sequencing of the human genome has shown that the ~3 billion base pairs are 99.9% identical in every person. This also means that individuals are, on average, 0.1% different genetically from every other person on the planet. And within that 0.1% lies the mystery of why some people are more susceptible to a particular illness, or more likely to be healthy, than another member of the population. The human genome contains more

**Table 10.1** Examples of Complex Diseases With Heritability Estimates Based on Twin/Family Studies and Calculated From Genome-Wide Association Studies (GWAS)

Trait or Disease	Twin/Family Study Heritability	Top GWAS SNPs (a)	All common SNPs (b)
Type 1 diabetes	0.9	0.6	0.3
Type 2 diabetes	0.3–0.6	0.05–0.1	
Obesity (BMI)	0.4–0.6	0.01–0.02	0.2
Crohn disease	0.6–0.8	0.1	0.4
Ulcerative colitis	0.5	0.05	
Multiple sclerosis	0.3–0.8	0.1	
Ankylosing spondylitis	>0.90	0.21	
Rheumatoid arthritis	0.6		
Schizophrenia	0.7–0.8	0.01	0.3
Bipolar disorder	0.6–0.7	0.02	0.4
Breast cancer	0.3	0.08	
Von Willebrand factor	0.66–0.75	0.13	0.2
Height	0.8	0.1	0.5
Bone mineral density	0.6–0.8	0.05	
QT interval	0.37–0.60	0.07	0.2
HDL cholesterol	0.5	0.1	
Platelet count	0.8	0.05–0.1	

GWAS estimates are either based on the known top signals associated with the trait (a) or by using all common variants without invoking a p value threshold(b). From: Visscher PM, Brown MA, McCarthy MI, Yang J 2012 Five years of GWAS discovery. *Am J Hum Genet* 90:7–24.

than 10 million single nucleotide polymorphisms (SNPs) that occur in greater than 1% of individuals, and our increased knowledge of genetic variation, together with high throughput SNP genotyping platforms, has revolutionized our ability to identify disease susceptibility loci for many common diseases and traits.

It is possible to determine whether particular variants occur more commonly in individuals affected with a particular disease than in the population in general, or what is known as **association**. Although demonstration of a polymorphic association can suggest that the inherited variation is involved in the etiology of the disorder, such as the demonstration of HLA associations in the immune response in the causation of the autoimmune disorders (p. 170), it may only reflect that a gene nearby in linkage disequilibrium (p. 92) is involved in causation of the disorder.

### Polygenic Inheritance and the Normal Distribution

The concept of **polygenic** inheritance, the cornerstone of **quantitative** genetics, was first proposed by Ronald Fisher in 1918 and is exemplified by variation in human height, the classic polygenic trait. The result is a normal distribution of the trait generated by many genes, known as **polygenes**, each acting in an additive fashion. Individuals who lie at the extreme ends of the distribution curve may be of clinical interest, e.g. those with idiopathic short or tall stature.

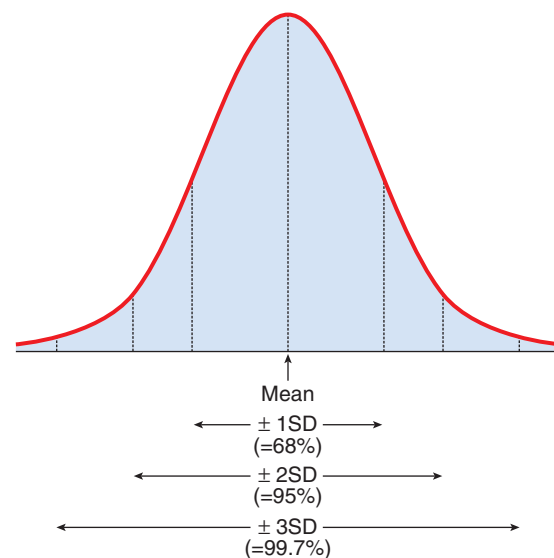
Several human characteristics (Box 10.2) show a continuous distribution in the general population, which closely resembles a normal distribution. This takes the form of a symmetrical bell-shaped curve distributed evenly about a mean (Figure 10.2). The spread of the distribution about the mean is determined by the standard deviation. Approximately 68%, 95%, and 99.7% of observations fall within the mean plus or minus one, two, or three standard deviations, respectively.

It is possible to show that a phenotype with a normal distribution in the general population can be generated by

### Box 10.2 Human Characteristics That Show a Continuous Normal Distribution

Blood pressure  
Dermatoglyphics (ridge count)  
Head circumference  
Height  
Intelligence  
Body mass index

polygenic inheritance involving the action of many genes at different loci, each of which exerts an equal additive effect. This can be illustrated by considering a trait such as height. If height were to be determined by two equally frequent alleles, 'a' (tall) and 'b' (short), at a single locus, then this would result

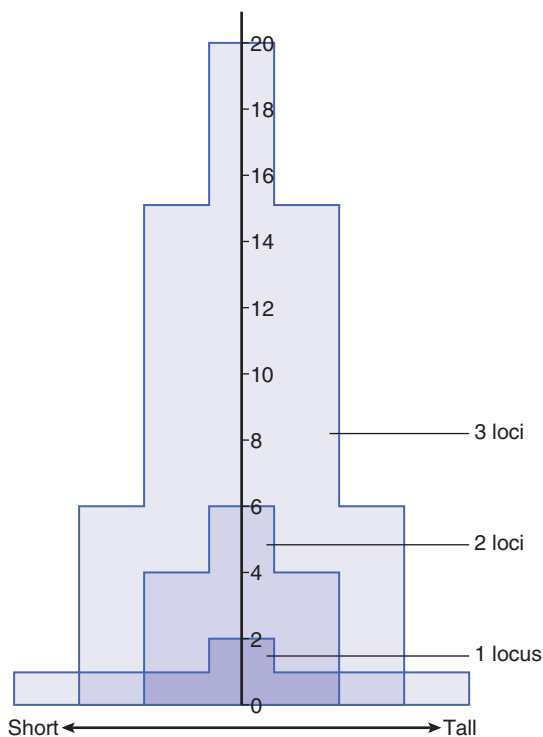


**FIGURE 10.2** The normal (Gaussian) distribution.

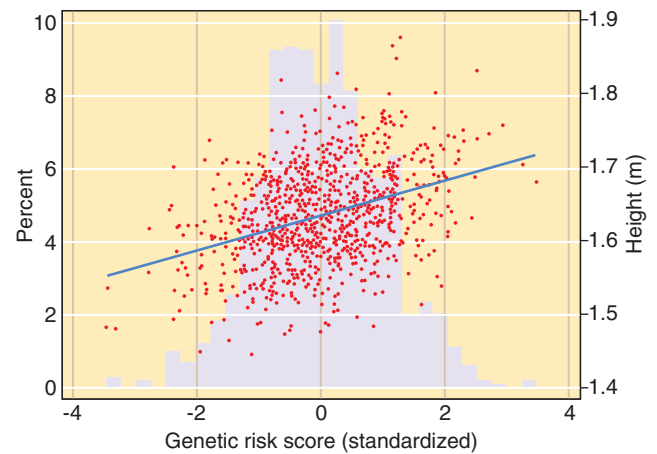
in a discontinuous phenotype with three groups in a ratio of 1 (tall-aa) to 2 (average-ab/ba) to 1 (short-bb). If the same trait were to be determined by two alleles at each of two loci interacting in a simple additive way, this would lead to a phenotypic distribution of five groups in a ratio of 1 (4 tall genes) to 4 (3 tall + 1 short) to 6 (2 tall + 2 short) to 4 (1 tall + 3 short) to 1 (4 short). For a system with three loci each with two alleles the phenotypic ratio would be 1-6-15-20-15-6-1 (Figure 10.3).

It can be seen that as the number of loci increases, the distribution increasingly comes to resemble a normal curve, thereby supporting the concept that characteristics such as height are determined by the additive effects of many genes at different loci. The prediction from this model has now been demonstrated with empirical data (Figure 10.4). Correlation is a statistical measure of the degree of resemblance or relationship between two parameters. First-degree relatives share, on average, 50% of their genes (see Table 10.1). Therefore, if height is polygenic, the correlation between first-degree relatives should be 0.5. Several studies have shown that the sib-sib correlation for height is indeed close to 0.5.

In reality, human characteristics such as height and intelligence are also influenced by environment, and possibly also by genes that are not additive in that they exert a dominant effect. These factors probably account for the observed tendency of offspring to show what is known as **regression to the mean**. This is demonstrated by tall or intelligent parents (the two are not mutually exclusive!) having children whose average height or intelligence is slightly lower than the average or mid-parental value. Similarly, parents who are very short or of low



**FIGURE 10.3** Distribution of genotypes for a characteristic such as height with 1, 2, and 3 loci each with two alleles of equal frequency. The values for each genotype can be obtained from the binomial expansion  $(p + q)^{2n}$ , where  $p = q = 1/2$  and  $n$  equals the number of loci.



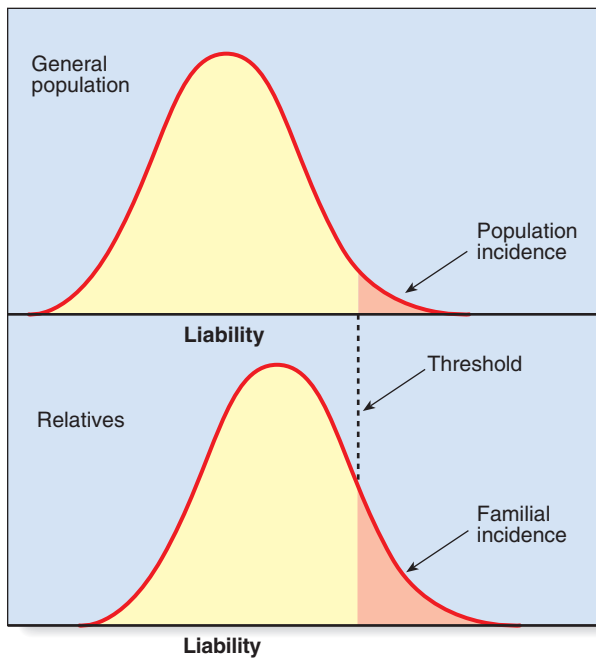
**FIGURE 10.4** The combined effect of 697 common variants, which explain 20% of the heritability of height, on the variation of height in a population of 1000 adult women. The scatter plot indicates the mean height for individuals carrying each risk score for height genes and the histogram illustrates the percentage of individuals carrying that risk score. The risk score has been standardized so that it has a mean of 0 and standard deviation of 1. There is a difference in mean height of about 1.5 cm between those individuals with the fewest compared with the greatest number of height-increasing variants.

intelligence tend to have children whose average height or intelligence is lower than the general population average, but higher than the average value of the parents. If a trait were to show true polygenic inheritance with no external influences, then the measurements in offspring would be distributed evenly around the mean of their parents' values.

### Multifactorial Inheritance—the Liability/Threshold Model

For disease states such as type 1 diabetes mellitus (T1DM), the genetic contribution involves many loci, but the phenotype does not have a continuous distribution, it is either present or absent. The polygenic theory for the inheritance of quantitative or continuous traits accounts for **discontinuous** multifactorial disorders, such as T1DM or cleft lip, with the **liability/threshold** model, proposed by Sewall Wright in 1934. All of the factors which influence the development of a multifactorial disorder, whether genetic or environmental, can be considered as a single entity known as liability. The liabilities of all individuals in a population form a continuous variable, which has a normal distribution in both the general population and in relatives of affected individuals. However, the curves for these relatives will be shifted to the right, with the extent to which they are shifted being directly related to the closeness of their relationship to the affected index case, indicating an increased shared genetic burden (Figure 10.5).

It is important to emphasize again that liability includes all factors that contribute to the cause of the condition. Looked at very simply, a deleterious liability can be viewed as consisting of a combination of several 'bad' genes and adverse environmental factors. This model of inheritance has been supported by numerous multifactorial discontinuous traits over the last 5 years, by genome wide association studies (p. 135), including schizophrenia, T2DM, rheumatoid arthritis, Crohn disease and various cancers.



**FIGURE 10.5** Hypothetical liability curves in the general population and in relatives for a hereditary disorder in which the genetic predisposition is multifactorial.

### Consequences of the Liability/Threshold Model

Part of the attraction of this model, is that it provides a simple explanation for the observed patterns of familial risks in conditions such as cleft lip/palate, pyloric stenosis, and spina bifida.

1. The incidence of the condition is greatest among relatives of the most severely affected patients, presumably because they are the most extreme deviants along the liability curve. For example, in cleft lip/palate the proportion of affected first-degree relatives (parents, siblings, and offspring) is 6% if the index patient has bilateral cleft lip and palate, but only 2% if the index patient has a unilateral cleft lip (Figure 10.6).
2. The risk is greatest among close relatives of the index case and decreases rapidly in more distant relatives. For example, in spina bifida the risks to first-, second-, and third-degree relatives of the index case are approximately 4%, 1%, and less than 0.5%, respectively.
3. If there is more than one affected close relative, then the risks for other relatives are increased. In spina bifida, if one sibling is affected the risk to the next sibling (if folic acid is not taken by the mother periconceptionally) is approximately 4%; if two siblings are affected; the risk to a subsequent sibling is approximately 10%.
4. If the condition is more common in individuals of one sex, then relatives of an affected individual of the less frequently affected sex will be at higher risk than relatives of an affected individual of the more frequently affected sex. This is illustrated by the condition pyloric stenosis. Pyloric stenosis shows a male to female ratio of 5 to 1. The proportions of affected offspring of male index patients are 5.5% for sons and 2.4% for daughters, whereas the risks to the offspring of female index patients are 19.4% for sons and 7.3% for daughters. The probable explanation for these different risks is that for a female to be affected, she has to lie at the extreme of the liability curve, so that her close relatives will

also have a very high liability for developing the condition. Because males are more susceptible to developing the disorder, risks in male offspring are higher than in female offspring regardless of the sex of the affected parent.

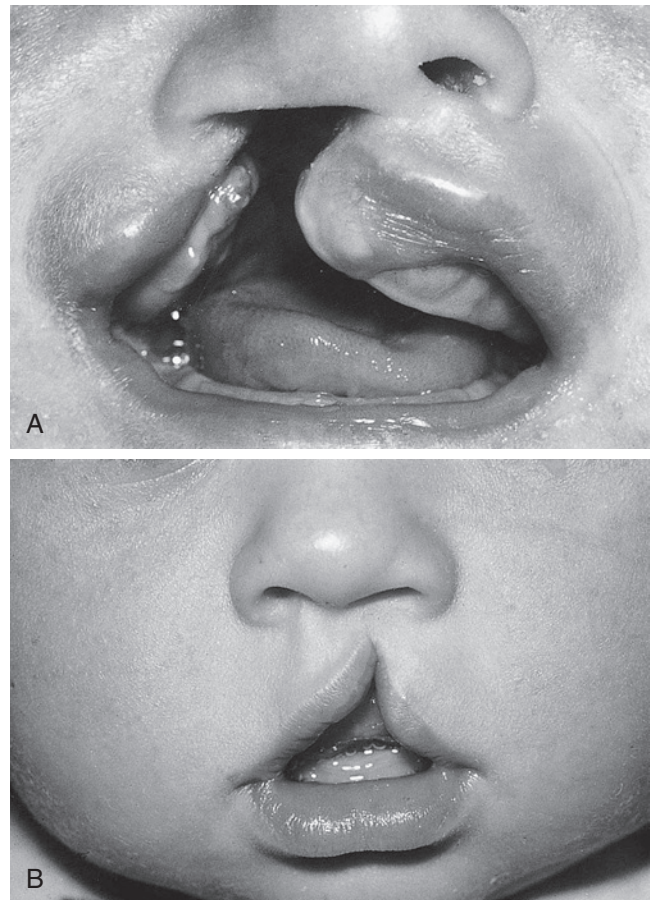
5. The risk of recurrence for first-degree relatives (i.e., siblings and offspring) approximates to the square root of the general population incidence. Thus if the incidence is 1 in 1000, the sibling and offspring risk will equal approximately 1 in 32, or 3%.

### Identifying Genes That Cause Multifactorial Disorders

Multifactorial disorders are common and make a major contribution to human morbidity and mortality (p. 6). Vigorous efforts have been made over recent years to identify genes that contribute to their etiology. Early studies focused on methods used in monogenic disease, such as linkage analysis (p. 91), but these were largely unsuccessful. In 2007 the results from the first large scale genome-wide association studies were published and this has revolutionized the field of complex trait genetics.

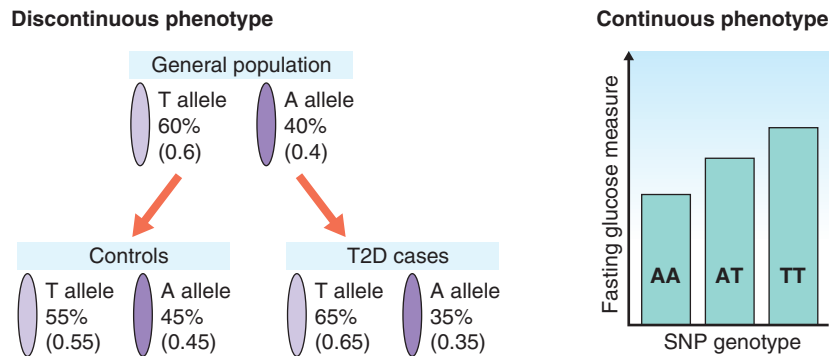
### Association Studies

Association studies are undertaken by comparing the frequency of a particular variant in affected patients with its frequency in a control group. This approach is often described as a **case-control** study. If the frequencies in the two groups differ significantly, this provides evidence for an association. For



**FIGURE 10.6** Severe (A) and mild (B) forms of cleft lip/palate.





**FIGURE 10.7** Illustration of the principle of association testing, using diabetes as an example, with a single SNP. Studies may either test allele frequency differences between cases and controls for a disease phenotype, or compare mean trait values for each genotype group (e.g. for fasting glucose).

quantitative traits the mean trait value for each genotype group is compared and significant differences provide evidence for an association (Figure 10.7).

The polymorphic HLA histocompatibility complex on chromosome 6 (p. 170) has been frequently studied. One of the strongest known HLA associations is that between ankylosing spondylitis and the B27 allele. This is present in approximately 90% of all patients and in only 5% of controls. The strength of an association is indicated by the ratio of the odds of developing the disease in those with the antigen to the odds of developing the disease in those without the antigen (Table 10.2). This is known as the **odds ratio** and it gives an indication of how much more frequently the disease occurs in individuals with a specific marker than in those without that marker. For the HLA-ankylosing spondylitis association, the odds ratio is 171. However, for most markers associated with multifactorial disease, the frequency difference between cases and controls is small, giving rise to modest odds ratios (usually between 1.1 and 1.5).

If evidence for association is forthcoming, this suggests that the allele encoded by the marker is either directly involved in causing the disease (i.e., a susceptibility variant) or that the marker is in linkage disequilibrium with a closely linked susceptibility variant. When considering disease associations, it is important to remember that the identification of a susceptibility locus does not mean that the definitive disease gene has been identified. For example, although it is one of the strongest disease associations known, only 1% of all HLA B27 individuals develop ankylosing spondylitis, so that many other factors, genetic and/or environmental, must be involved in causing this condition.

Before 2006, association studies were carried out by first selecting a candidate gene or genomic region, which would either have plausible biological links to the disease of interest or be situated in a region of linkage. One or more genetic

variants were selected from the gene or gene region and genotyped in cases and controls to test for association with the disease. Many studies showing evidence of association with candidate genes were published for a variety of diseases and traits. However, in numerous cases, these associations did not replicate in independent studies, leaving the validity of many of the initially reported associations unclear. The reasons for this inconsistency included (1) small sample sizes, (2) weak statistical support, and (3) the low prior probability of any of the few selected variants being genuinely associated with the disease. All of these features increased the chances of false-positive associations. In addition, false-positive associations were found to be due to population stratification, in which the population contains subgroups of different ancestries and both the disease and the allele happen to be common within that subset. A famous example was reported in a study by Lander and Schork which showed, in a San Francisco population, that HLA-A1 is associated with the ability to eat with chopsticks. This association is simply explained by the fact that HLA-A1 is more common among Chinese than Europeans!

The candidate gene approach led to only a handful of widely replicated associations. Two important developments made it possible to move away from this approach, toward a genome-wide approach to association studies: the first was the development of microarray technology to genotype hundreds of thousands of SNPs in thousands of individuals quickly and at little cost; the second was the creation of a reference catalogue of SNPs and linkage disequilibrium, the International Haplotype Map (HapMap).

### HapMap Project ([www.1000genomes.org](http://www.1000genomes.org) or <ftp://ftp.ncbi.nlm.nih.gov/hapmap/>)

Although it is estimated that there are over 10 million SNPs in the human genome, many SNPs are in linkage disequilibrium (p. 92) and therefore co-inherited. Regions of linked SNPs are known as haplotypes. The International HapMap project was set up to identify SNP frequencies and haplotypes in different populations and make that data freely publically available. The project genotyped more than 3 million SNPs in 270 samples from Europe, East Asia, and West Africa.

### Genome-Wide Association Studies

In **genome-wide association (GWA)** studies, researchers compare variants across the entire genome, rather than looking at just one variant at a time. Since 2006, this powerful new method has produced an explosion in the number of widely

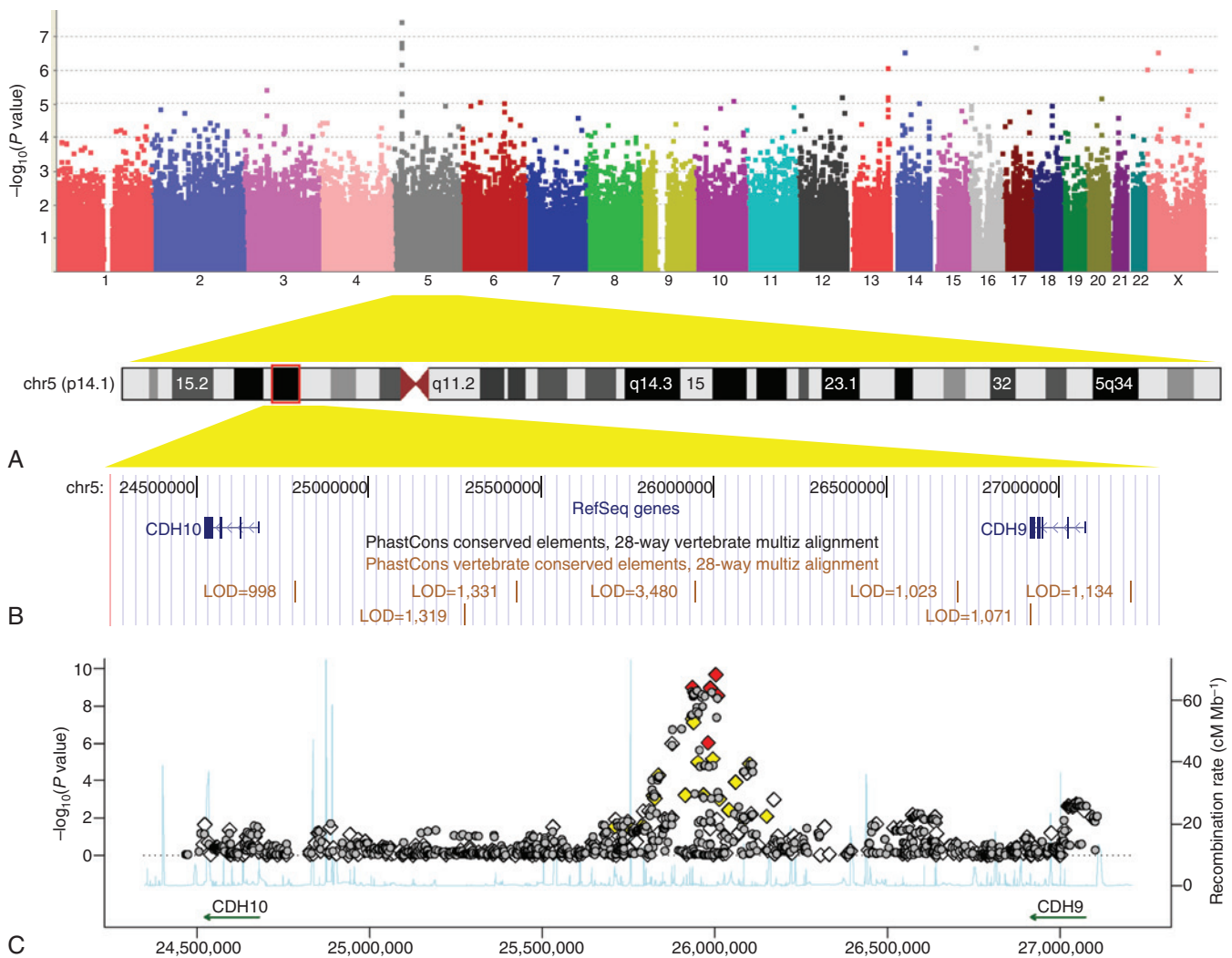
**Table 10.2** Calculation of Odds Ratio for a Disease Association

	Allele 1	Allele 2
Patients	a	b
Controls	c	d
Odds ratio	$= \frac{a/c}{b/d}$ $= \frac{ad}{bc}$	

replicated associations between SNPs and common diseases, which are catalogued at <http://www.ebi.ac.uk/gwas/>. By 2014, GWA studies had identified thousands of reproducible associations with over 600 common diseases or traits. The results of a GWA study of autism are shown in Figure 10.8. In a typical GWA study, 500,000 to 1,000,000 SNPs are genotyped in each subject using a single microarray ('SNP chip').

A clear advantage of GWA studies over the candidate gene approach is that they are 'hypothesis-free'. No prior assumption is made about the genes likely to be involved in the disease, and as a result, associations have been uncovered which provide new insights into biological pathways, opening up new avenues for research.

It has been important to develop new statistical criteria for GWA studies. If we were to perform a statistical test of association comparing the frequency of one SNP between cases and controls, we might interpret a  $P$  value of  $<.05$  as being unlikely to have occurred by chance. However, when testing associations with increasing numbers of SNPs, the  $P$  value threshold needs to change: 1 in 20 tests will have a  $P$  value  $<.05$  just by chance. Based on HapMap European data, there are approximately 1 million common SNPs in the genome that are independent (i.e., in very low linkage disequilibrium with all others). Therefore, a comprehensive GWA study of common variants is equivalent to testing approximately 1 million hypotheses. Consequently, in GWA studies,  $P = 5 \times 10^{-8}$  is the



**FIGURE 10.8** Results of a genome-wide association study of autism spectrum disorders. **A**, 'Manhattan plot' of  $-\log_{10}(P \text{ value})$  against genomic position. Each data point represents the association between an individual single nucleotide polymorphism (SNP) and autism. SNPs are ordered according to their position in the genome and each chromosome is colored differently. The higher the position on the y-axis, the stronger the evidence for association. SNPs on chromosome 5p14.1 show the strongest associations. **B**, The 5p14.1 genomic region as displayed in the UCSC genome browser (<http://genome.ucsc.edu/>). **C**, Zooming in on the 5p14.1 region: Both genotyped SNPs (diamonds) and imputed SNPs (inferred from linkage disequilibrium with genotyped SNPs; grey circles) are plotted with  $-\log_{10}(P \text{ value})$  (y-axis) against genomic position (x-axis). Genotyped SNPs are colored on the basis of their correlation with the most strongly associated SNP (red = high, yellow = medium, white = low). Estimated recombination rates from HapMap data are plotted to reflect the local linkage disequilibrium structure. LOD, Logarithm of odds; RefSeq, reference sequence. (From Wang K, Zhang H, Ma D, et al 2009 Common genetic variants on 5p14.1 associated with autism spectrum disorders. *Nature* 459:528–533, with permission.)

accepted threshold below which an association is unlikely to be a false positive. Large sample sizes are needed to achieve such low  $P$  values, and meta-analysis of multiple studies is a common approach to enlarge the sample size. Dense SNP data can be used to identify population stratification in GWA studies. For example, if an individual shows allele frequency differences from the rest of the study sample at thousands of SNPs, this may indicate that they are of different ancestry and may lead to their exclusion from the study.

Initially GWAS focused on common variation, i.e. SNPs with a minor allele frequency greater than 5%. However despite identifying multiple loci, for most traits initial studies were only able to explain a relatively small proportion of the trait variability, typically less than 10%. Rarer variants, not captured by the GWA approach, may explain some of this **missing heritability**. Common variants found to date have relatively modest effect sizes, for example for human height a typical GWAS SNP alters adult height by less than 1mm per allele. This has led to the hypothesis that much of the missing heritability lies in a rarer variation that has a larger effect size per allele, i.e. intermediate between classic monogenic disease-causing alleles and the typical common GWAS SNPs (Figure 10.9). Some of this rarer variation is captured with specialized SNP arrays, or **exome chips**, that are enriched for SNPs in the coding sequence. Rarer variation in the non-coding regions can also be evaluated by using **imputation**.

### Imputation

Most SNPs are strongly correlated to one or more others nearby and by genotyping only a proportion of SNPs we can infer genotypes for others based on these linkage disequilibrium patterns. This means that by genotyping approximately 500,000 SNPs in most populations, we can capture information on the majority of common SNPs in the human genome (with minor allele frequency  $>5\%$ ). The added advantage of imputation is that studies that have used different genotyping arrays can impute missing SNPs and thus studies can be meta-analyzed easily. Imputation relies on using a **reference panel** of genomic

data and the larger and more detailed the reference panel allows more and rarer untyped SNPs to be imputed.

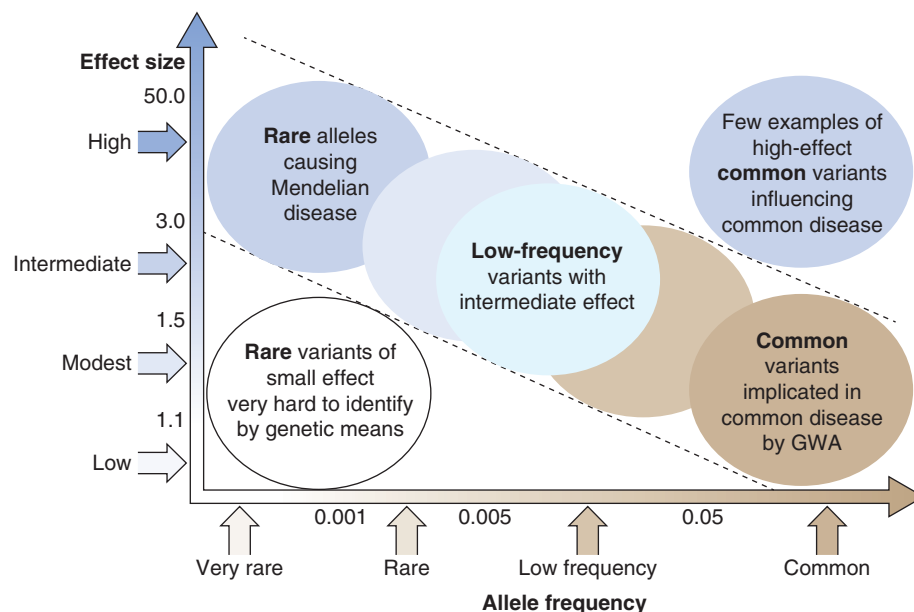
### Reference Panels

The reference panel was originally provided by the HapMap consortium, but since 2013 additional reference panels have become available based on whole genome sequence data rather than SNP genotypes. The **thousand genomes project** ([www.1000genomes.org](http://www.1000genomes.org)) provides an accurate map of alleles with frequencies as low as 1% and will capture not only SNPs but other types of variation including copy number polymorphisms (duplications, deletions, and other structural variation). The **Haplotype Reference Consortium** (<http://www.haplotype-reference-consortium.org/>) is compiling an even more comprehensive map of the human genome which will allow more detailed analysis of rarer variation in the genome.

Despite the success of GWA studies, many challenges remain. To date, the associations identified only explain a small fraction of the susceptibility to each disease studied (e.g.,  $<10\%$  in type 2 diabetes and  $<20\%$  in Crohn disease). Over 10,000 SNPs have been reported from GWAS, associated with hundreds of traits and diseases, but 90% of those SNPs fall in non-coding regions of the genome. In addition, the loci identified generally range from 10 to 100 kb in length and include numerous associated SNPs. This means that it has not been possible in most cases to identify the causal variants or even the causal genes. Further techniques, including resequencing of the associated regions, testing in different ethnic groups, examining expression data and functional studies will be necessary to understand the associations fully.

### Disease Models for Multifactorial Inheritance

The search for susceptibility loci in human multifactorial disorders has met with increasing success in recent years, largely due to the success of GWA studies. Examples of recent research in some common conditions will be considered to



**Figure 10.9** Feasibility of identifying genetic variants by risk allele frequency and strength of genetic effect (odds ratio). Manolio TA, Collins FS, Cox NJ, et al, 2009 Finding the missing heritability of complex diseases. *Nature* 461(7265):747–753, with permission.

illustrate the progress to date and the extent of the challenges that lie ahead.

### Diabetes Mellitus (DM)

There are two main forms of DM that are clinically distinct. T1DM is the rarer juvenile-onset, insulin-dependent form (previous abbreviation IDDM) which affects 0.4% of the population and shows a high incidence of potentially serious renal, retinal, and vascular complications. T1DM has a peak age of onset in adolescence and can only be controlled by regular injection of insulin. Type 2 is the more common later-onset, non-insulin-dependent form that affects up to 10% of the population and is strongly associated with overweight and obesity. It usually affects older persons and may respond to simple weight loss, although many people with T2DM require oral hypoglycemic medication, and some require insulin. An additional 1% to 2% of persons with diabetes have **monogenic** (single gene) forms of diabetes.

Up to 10% of women develop glucose intolerance during pregnancy. This is known as **gestational** diabetes. Their abnormal glucose tolerance usually reverts to normal after the pregnancy; although these women have an increased risk of developing T2DM later in life.

Diabetes can also occur secondary to a variety of other rare genetic syndromes and non-genetic disorders. Examples include Prader-Willi syndrome (p. 78), Bardet-Biedl syndrome, Wolfram syndrome, and Friedreich ataxia (p. 275). Diabetes mellitus is therefore etiologically heterogeneous.

#### Type 1 Diabetes

Initial research into the genetics of diabetes tended to focus on type 1 diabetes, where there is greater evidence for familial clustering ( $\lambda_s$  is 15 for T1DM versus 3.5 for T2DM [p. 133]). The concordance rates in monozygotic and dizygotic twins are approximately 50% and 12%, respectively. These observations point to a multifactorial etiology with both environmental and genetic contributions. Known environmental factors include diet, viral exposure in early childhood, and certain drugs. The disease process involves irreversible destruction of insulin-producing islet  $\beta$  cells in the pancreas by the body's own immune system, perhaps as a result of an interaction between infection and an abnormal genetically programmed immune response.

The first major breakthrough came with the recognition of strong associations with the HLA region on chromosome 6p21. The original associations were with the HLA B8 and B15 antigens that are in linkage disequilibrium with the DR3 and DR4 alleles (pp. 134, 170). It is with these that the T1DM association is strongest, with 95% of affected individuals having DR3 and/or DR4 compared with 50% of the general population. Following the development of PCR analysis for the HLA region, it was shown that the HLA contribution to T1DM susceptibility is determined by the 57th amino acid residue at the DQ locus, where aspartic acid conveys protection, in contrast to other alleles that increase susceptibility. The HLA region contributes approximately 50% of the genetic susceptibility to T1DM.

The next locus to be identified was the insulin gene on chromosome 11p15, where it was shown that variation in the number of tandem repeats of a 14-bp sequence upstream to the gene (known as the *INS VNTR*) influences disease susceptibility. It is hypothesized that long repeats convey protection by increasing expression of the insulin gene in the fetal thymus

gland, thereby reducing the likelihood that insulin-producing  $\beta$  cells will be viewed as foreign by the mature immune system.

These two loci contribute  $\lambda_s$  values of approximately 3 and 1.3, respectively. However, the total risk ratio for T1DM is approximately 15. Numerous genome-wide association studies of increasing size have led to an explosion in the number of T1DM susceptibility loci supported by robust statistical evidence, bringing the total to over 50 distinct genomic locations. It is likely that many more remain to be identified through future, even larger, efforts. Most of the identified loci confer a modest increase in the risk of T1DM, with odds ratios (p. 134) ranging from 1.1 to 1.3 for each inherited allele, in contrast with the much larger role of the HLA locus. In most cases, the causal genes and variants underlying the associations have yet to be identified. However, the regions of association often encompass strong biological candidates—for example, the interleukin genes, *IL10*, *IL19*, *IL20*, and *IL27*. In two notable cases, follow-up studies have already enabled the causal gene to be confirmed, deepening our understanding of the biological pathways behind the associations.

The first example was a study of the *IL2RA* (*CD25*) locus by Dendrou et al (2009). It used the UK-based Cambridge BioResource, a collection of approximately 5000 volunteers who can be recalled to participate in research on the basis of their genotype. Using fewer than 200 of these individuals, and by means of flow cytometry to assay the levels of CD25 protein expressed on the surface of T-regulatory cells, the study showed that people with the T1DM-protective haplotype expressed higher CD25 levels. This confirmed that *IL2RA* is indeed the causal gene and that the genotype-phenotype association is mediated via differences in expression of the gene product.

In the second study by Nejentsev et al (2009), the exons and splice sites of 10 candidate genes situated in regions of genome-wide association were resequenced in 480 T1DM patients and 480 controls. Variants identified were then tested for association with the disease in 30,000 further subjects. Four rare variants (minor allele frequency  $\approx$  1% to 2%) in the *IFIH1* gene were identified, each of which independently reduced the odds of T1DM by about 50%. This finding demonstrated that the *IFIH1* gene is important in the etiology of T1DM. Since its function is to mediate the induction of an interferon response to viral RNA, it adds to the evidence implicating viral infection in the development of the disease. These results also demonstrate that there may be both high- and low-frequency susceptibility variants at the same locus, with varying effect sizes. Future follow-up by resequencing of other loci, both in T1DM and in other diseases, should lead to the identification of even more of these variants and a better understanding of the loci.

#### Type 2 Diabetes

The prevalence of T2DM is increasing and is predicted to reach 300 million affected worldwide by 2025. Although commonly believed to be more benign than the earlier-onset, insulin-dependent T1DM diabetes, patients with T2DM are also prone to both macrovascular and microvascular diabetic complications, with corresponding excess morbidity and mortality.

GWAS has identified over 90 susceptibility loci for T2DM. There is no overlap with the T1DM loci, illustrating that these two diseases have very different etiologies. Unlike the HLA and *INS VNTR* loci in T1DM, there are no major predisposing loci associated with T2DM. Most odds ratios are modest (between 1.05 and 1.3 per allele), but by combining variants



In 2001, two groups working independently and using different approaches identified disease-predisposing variants in the *CARD15* gene (previously known as *NOD2*). One of the groups, Ogura et al, had previously identified a Toll-like receptor (p. 164), *NOD2*, which activates nuclear factor Kappa-B (NFκB) (p. 171), making it responsive to bacterial lipopolysaccharides. Sequence analysis revealed three variants (R702W, G908R and 3020insC) that were shown by case-control and transmission disequilibrium tests to be associated with Crohn disease. The second group, Hugot et al, fine-mapped the 16p12 region by genotyping SNPs within the 20Mb interval and also arrived at the same variants within the *CARD15* gene. These variants are found in up to 15% of patients with Crohn disease but only 5% of controls. The relative risk conferred by heterozygous and homozygous genotypes was approximately 2.5 and 40, respectively. For therapy, drugs which target the NFκB complex (p. 171) are already the most effective drugs currently available.

Since 2006, GWA studies have identified nearly 200 susceptibility loci for inflammatory bowel disease, all of which confer more modest risks of disease than the *CARD15* variants (odds ratios per allele between 1.1 and 2.5). The genes identified implicate innate immunity, T cell signaling and epithelial barrier function as the predominant etiological mechanisms in IBD. Discoveries of loci containing the *IRGM* and *ATG16L1* genes were particularly exciting findings, as these genes are essential for autophagy, a biological pathway whose relevance to the disease was previously unsuspected. Further studies of the *IRGM* locus by McCarroll et al (2008) identified that the causal variant is a 20-kb deletion immediately upstream of *IRGM*, which is in linkage disequilibrium (p. 92) with the associated SNPs. The deletion results in altered patterns of gene expression, which in turn were shown to modulate the autophagy of bacteria inside cells.

### Coronary Artery Disease

Coronary artery disease is the most common cause of death in industrialized countries and is rapidly increasing in prevalence in developing countries. It results from atherosclerosis, a process taking place over many years which involves the deposition of fibrous plaques in the subendothelial space (intima) of arteries, with a consequent narrowing of their lumina. Narrowing of the coronary arteries compromises the metabolic needs of the heart muscle, leading to myocardial ischemia, which if severe, results in myocardial infarction.

For the majority of persons, their risk of coronary artery disease is multifactorial or polygenic in origin. A variety of different genetic and environmental risk factors have been identified that predispose to early onset of the atherosclerotic process, including lack of exercise, dietary saturated fat, and smoking.

### Lipid Metabolism

The metabolic pathways by which the body absorbs, synthesizes, transports, and catabolizes dietary and endogenous lipids are complex. Lipids are packaged in intestinal cells as a complex with various proteins known as **apolipoproteins** to form triglyceride-rich chylomicrons. These are secreted into the lymph and transported to the liver, where, in association with endogenous synthesis of triglyceride and cholesterol, they are packaged and secreted into the circulation as triglyceride-rich very low-density lipoproteins (VLDLs). VLDL is degraded to intermediate-density lipoprotein (IDL), which is further broken down into cholesterol-rich low-density lipoprotein

**Table 10.3** Recurrence Risks for Premature Coronary Artery Disease

Proband	Relative Risk
<b>Male (&lt;55 Y)</b>	
Brother	5
Sister	2.5
<b>Female (&lt;65 Y)</b>	
Siblings	7

Data from Slack J, Evans KA 1966 The increased risk of death from ischemic heart disease in first degree relatives of 121 men and 96 women with ischemic heart disease. *J Med Genet* 3:239–257

(LDL). High-density lipoproteins (HDLs) are formed from lipoproteins secreted by the liver, chylomicrons, and VLDL remnants.

High levels of LDLs are associated with an increased risk of coronary artery disease. Conversely, high levels of HDLs are inversely correlated with a risk of coronary artery disease. Consequently, the LDL:HDL ratio has been used as a risk predictor for coronary artery disease and as an indicator for therapeutic intervention. Statins are effective drugs for lowering LDL cholesterol levels.

### Family and Twin Studies

The risk to a first-degree relative of a person with premature coronary artery disease, defined as occurring before age 55 in males and age 65 in females, varies between two and seven times that for the general population (Table 10.3). Twin studies of concordance for coronary artery disease vary from 15% to 25% for dizygotic twins and from 39% to 48% for monozygotic twins. Although these figures support the involvement of genetic factors, the low concordance rate for monozygotic twins clearly supports the importance of environmental factors.

### Single-Gene Disorders of Lipid Metabolism Leading to Coronary Artery Disease

Although there are a number of individually rare inherited disorders of specific lipoproteins, levels of the various lipoproteins and the hyperlipidemias are determined by a complex interaction of genetic and environmental factors. Family studies of some of the hyperlipidemias are, however, consistent with a single gene being a major factor determining genetic susceptibility.

### Familial Hypercholesterolemia

The best-known disorder of lipid metabolism is familial hypercholesterolemia (FH) (p. 262). FH is associated with a significantly increased risk of early coronary artery disease and is inherited as an autosomal dominant disorder. It has been estimated that about 1 person in 500 in the general population, and about 1 in 20 persons presenting with early coronary artery disease, are heterozygous for a mutation in the low-density lipoprotein receptor (*LDLR*) gene. Molecular studies in FH have revealed that it is due to a variety of defects in the number, function, or processing of the LDL receptors on the cell surface (p. 263).

### Susceptibility Genes

Since 2007, numerous large-scale GWA and follow-up replication studies have identified nearly 60 susceptibility loci for coronary artery disease and myocardial infarction. Of these loci about a third are also associated with lipid levels and 10% with

blood pressure and the key pathways implicated in the pathogenesis of coronary artery disease from GWAS are lipid metabolism, inflammation and artery vessel wall structure. One of the strongest associations identified is on chromosome 9p21 (odds ratio per allele  $\approx 1.3$ ). The nearest genes, *CDKN2A* and *CDKN2B*, are over 100 kb away. Interestingly, the SNPs most strongly associated with coronary artery disease are only 10 kb away from those associated with type 2 diabetes. However, the two disease associations are independent and not in linkage disequilibrium with one another. Much work is already being done to investigate the role of *ANRIL*, a large, non-coding RNA which overlaps with the coronary artery disease-associated haplotype. It is expressed in tissues associated with atherosclerosis, and studies have shown correlations between expression of *ANRIL* transcripts and severity of atherosclerosis. However, additional evidence from large-scale association studies has shown that the same haplotype on 9p21 is associated with abdominal aortic aneurysm and intracranial aneurysm, suggesting that its role is not limited to atherosclerotic disease. Together with the other 59 loci, the locus at 9p21 only explains a small fraction of the heritability of coronary artery disease (approximately 6%), and it is likely that many more loci will be identified.

Progress in uncovering susceptibility loci has also come from large GWA studies of lipid levels. Common variants in at least 150 loci are now robustly associated with circulating levels of lipids, with over one-third of these associated with LDL levels. In addition to common variants, low frequency variants have also been associated with lipid levels and together these variants explain 9.3%, 12.8%, 19.5%, and 18.8% of the variance in triglycerides, HDL cholesterol, LDL cholesterol, and total cholesterol concentrations, respectively. The frequency of LDL-raising alleles is higher in patients with coronary artery disease than in controls, indicating that they predispose to the disease via their primary effect on LDL levels. In many cases, the genes implicated by the loci are already associated with single-gene disorders. For example, *PCSK9* harbors a full spectrum of LDL-altering alleles, from rare mutations which cause large differences in LDL (>100 mg/dL), through low-frequency variants with more modest effects (e.g., *PCSK9* R46L has a 1% minor allele frequency and a 16 mg/dL effect size), to common variants at 20% minor allele frequency which change LDL levels by less than 5 mg/dL. Monoclonal antibody *PCSK9* inhibitors have now been approved for use as cholesterol lowering agents and could provide an alternative to statin treatment. The resequencing of further loci is likely to uncover rarer variants and mutations at lipid trait loci, which may further explain genetic susceptibility to coronary artery disease.

## Schizophrenia

Schizophrenia is a serious psychotic illness with an onset usually in late adolescence or early adult life. It is characterized by grossly disorganized thought processes and behavior, together with a marked deterioration of social and occupational functioning, and can be accompanied by hallucinations and delusions.

### Epidemiology

Schizophrenia is a principal cause of chronic mental illness. There is a 1% lifetime risk for a person to develop schizophrenia, and at any one time, approximately 0.2% of the population is affected. Schizophrenia occurs more commonly in individuals of poorer socioeconomic status and has an earlier age of onset and worse prognosis in males. There is an excess of winter births in schizophrenic individuals, which has suggested that environmental factors such as certain viral infections or nutritional factors could be contributory.

### Evidence for Genetic Factors

The nature and extent of the genetic contribution to schizophrenia is unclear. This is partly because of past and continuing controversy concerning the definition of schizophrenia and the term *schizoid*. The latter term refers to the schizophrenia-like traits often seen in relatives of schizophrenics. The problem arises because clinical criteria to distinguish schizoid from normal personality are lacking. For the sake of simplicity, we can regard the term *schizoid* as referring to a person with the fundamental symptoms of schizophrenia but in a milder form. It has been estimated that roughly 4% of the general population have schizophrenia or a schizoid personality disorder.

### Family and Twin Studies

The results of several studies of the prevalence of schizophrenia and schizoid disorder among the relatives of schizophrenics are summarized in Table 10.4. If only schizophrenia is considered, the concordance rate for identical twins is only 46%, suggesting the importance of environmental factors. If, however, schizophrenia and schizoid personality disorder are considered together, then almost 90% of identical co-twins are concordant.

### Susceptibility Genes

Genome-wide association studies of copy number variations (CNVs) have identified large (>500 kb) deletions associated with the condition—for example on chromosomes 1q21.1, 15q13.3, and 22q11.2 (pp. 245, 250). These deletions are rare but penetrant: the odds ratio for the 15q13.3 deletion has been

**Table 10.4** Proportions (%) of First-Degree Relatives of Individuals With Schizophrenia Who Are Similarly Affected or Have a Schizoid Disorder<sup>a</sup>

Relatives	Proportion (%) of Relatives		
	Schizophrenia <sup>b</sup>	Schizoid	Total Schizophrenia + Schizoid
Identical twins	46	41	87
Offspring (of 1 schizophrenic)	16	33	49
Siblings	14	32	46
Parents	9	35	44
Offspring (of 2 schizophrenics)	34	32	66
General population	1	3	4

<sup>a</sup>From Heston LL 1970 The genetics of schizophrenia and schizoid disease. *Science* 167:249–256.

<sup>b</sup>Age corrected.

estimated at between 16 and 18 in two independent studies. A key observation is that these deletions are not only associated with schizophrenia. The 1q21.1 deletion (p. 248) has also been associated with autism, learning disability, and epilepsy. Thus, current clinically defined disease boundaries are not mirrored by the underlying genetics. While these deletions explain some of the genetic susceptibility to schizophrenia, they also explain susceptibility to other conditions. It is likely that a better understanding of the genetics will lead to better definition of clinical phenotypes.

Common genetic variants are also implicated in the etiology of schizophrenia. Recent meta-analyses of GWA studies have identified over 100 associated loci, including the HLA region on chromosome 6p21.3-6p22.1, suggesting an immune system component to the risk of disease. Robust associations have also been observed with variants near the *NRGN* gene and in the *TCF4* gene, which implicate biological pathways involved in brain development, cognition, and memory. There are likely to be many more common and rare variants that collectively contribute to the heritability of schizophrenia.

## Alzheimer Disease

Dementia is characterized by an irreversible and progressive global impairment of intellect, memory, social skills, and control of emotional reactions in the presence of normal consciousness. Dementia is etiologically heterogeneous, occurring secondarily to both a variety of non-genetic causes such as vascular disease and infections such as AIDS, as well as genetic causes. Alzheimer disease (AD) is the most common cause of dementia in persons with either early-onset dementia (<60 years, or presenile) or late onset (>60 years, or senile). The classic neuropathological finding in persons with AD is the presence at postmortem examination of amyloid deposits in neurofibrillary tangles and neuronal or senile plaques. In addition, individuals with Down syndrome have an increased risk of developing dementia (p. 236), which at postmortem has identical CNS findings to those seen in persons with typical AD.

## Epidemiology

Limited numbers of studies of the incidence and prevalence of AD are available, owing to problems of ascertainment. However, the risk of developing AD clearly increases dramatically with age (Table 10.5).

## Twin and Family Studies

Differences in the age of onset of AD in identical twins are consistent with the importance of environmental factors, but

**Table 10.5** Estimates of Age-Specific Cumulative Prevalence of Dementia

Age Interval (Y)	Prevalence (%)
<70	1.3
70–74	2.3
75–79	6.4
80–84	15.3
85–89	23.7
90–94	42.9
>95	50.9

From Heston LL 1992 Alzheimer's disease. Chapter 39 in King RA, Rotter JJ, Motulsky AG eds The genetic basis of common diseases. New York: Oxford University Press

there are difficulties with family studies in AD. Many studies are based on a clinical diagnosis. However, a significant proportion of persons with a clinical diagnosis of AD are found to have other causes at postmortem, such as cerebrovascular atherosclerotic disease. Attempts to confirm diagnoses in relatives who have died previously are often unsuccessful. Obviously, given the age of onset, it is generally neither practical nor possible to obtain funding for prospective studies of the risk to offspring. Therefore, family studies of the risk to siblings are the only practical type of family study to provide reliable data. Although there are numerous retrospective reports of families with AD that are consistent with autosomal dominant inheritance, recurrence risks in a number of studies for first-degree relatives are less than 10%. The risks are age related and are greater the younger the age at diagnosis in the affected individual.

## Biochemical Studies

The amyloid deposits in the neurofibrillary tangles and neuronal plaques have been shown to consist of the amyloid- $\beta$  A4 precursor protein (APP). The major protein component of the neurofibrillary tangles has been shown to be derived from a microtubule-associated protein (MAP) called *tau* ( $\tau$ ). Along with other MAPs, it interacts with  $\beta$ -tubulin to stabilize microtubules.

## Single-Gene Disorders

The identification of APP in the amyloid deposits of the neuronal plaques, its mapping in or near to the critical region of the distal part of chromosome 21q associated with the phenotypic features of Down syndrome (p. 236), and the increased risk of AD in persons with Down syndrome led to the suggestion that duplication of the *APP* gene could be a cause of AD. Evidence of linkage to the *APP* locus was found in studies of families with early-onset AD, and it is now known that mutations in the *APP* gene account for a small proportion of cases.

Evidence of linkage to early-onset AD was found for another locus on chromosome 14q. Mutations were identified in a proportion of affected individuals in one of a novel class of genes known as *presenilin-1* (*PSEN1*), now known to be a component of the Notch signaling pathway (p. 105). A large number of mutations in *PSEN1* have now been identified and account for up to 70% of familial early-onset AD. A second gene, *presenilin-2* (*PSEN2*), with homology to *PSEN1*, was mapped to chromosome 1q and has been shown to have mutations in a limited number of families with AD. *PSEN1* and *PSEN2* are integral membrane proteins containing multiple transmembrane domains that localize to the endoplasmic reticulum and the Golgi complex. All of the presenile dementias following autosomal dominant inheritance demonstrate high penetrance.

## Susceptibility Genes

Polymorphisms in the apolipoprotein E (*APOE*) gene are the most important genetic risk factor identified for late-onset AD. The locus was initially identified in the early 1990s through linkage studies. The *APOE* gene has three major protein isoforms,  $\epsilon 2$ ,  $\epsilon 3$ , and  $\epsilon 4$ . Numerous studies in various populations and ethnic groups have shown an increased frequency of the  $\epsilon 4$  allele in persons with both sporadic and late-onset familial AD. In addition, the  $\epsilon 2$  allele is associated with a decreased risk of the disease. The finding of apolipoprotein E in senile plaques and neurofibrillary tangles, along with its role in lipid



transport, possibly in relation to the nerve injury and regeneration seen in AD, provides further evidence for a possible role in the acceleration of the neurodegenerative process in AD.

Although the *APOE*  $\epsilon 4$  allele, found in up to 40% of cases, is a clearly important risk factor, the strongest association is with the age of onset rather than absolute risk of developing AD. The *APOE*  $\epsilon 4$  allele is therefore neither necessary nor sufficient for the development of AD, emphasizing the importance of other genetic and environmental etiological factors.

GWAS for AD has found over 20 loci associated with disease risk, but none has an effect comparable to *APOE*, the odds ratios ranging from 1.1 to 2.0. In fact even in combination the attributable risk of all common variants is less than that for *APOE*. The loci do however shed light on the pathogenesis of AD and there appear to be three predominant pathways involved: cholesterol and lipid metabolism; immune system and inflammatory response; and endosomal vesicle cycling. Further work will be needed to uncover the mechanisms underlying these associations, and it is likely that many more loci with more modest effects remain to be discovered.

### FURTHER READING

Albert, F.W., Kruglyak, L., 2015. The role of regulatory variation in complex traits and disease. *Nat. Rev. Genet.* 16, 197–212.

*This article highlights the challenges and approaches that can be used to take a region of association identified by GWAS through to understanding how that locus causes disease or variation in a trait.*

Falconer, D.S., 1965. The inheritance of liability to certain diseases estimated from the incidence among relatives. *Ann. Hum. Genet.* 29, 51–76.

*The original exposition of the liability/threshold model and how correlations between relatives can be used to calculate heritability.*

Fraser, F.C., 1980. Evolution of a palatable multifactorial threshold model. *Am. J. Hum. Genet.* 32, 796–813.

*An amusing and 'reader-friendly' account of models proposed to explain multifactorial inheritance.*

McCarthy, M.I., Abecasis, G.R., Cardon, L.R., et al., 2008. Genome-wide association studies for complex traits: consensus, uncertainty and challenges. *Nat. Rev. Genet.* 9, 356–369.

*Detailed review article on genome-wide association studies, which gives a comprehensive overview of the methods and highlights the various challenges which still need to be addressed in the search for complex disease genes.*

Visscher, P.M., Brown, M.A., McCarthy, M.I., Yang, J., 2012. Five years of GWAS discovery. *Am. J. Hum. Genet.* 90, 7–24.

*Summarises the progress made in as a result of the first five years of GWAS. It focusses on autoimmune and metabolic disease, but gives an excellent general overview of the field.*

Witte, J.S., Visscher, P.M., Wray, N.R., 2014. The contribution of genetic variants to disease depends on the ruler. *Nat. Rev. Genet.* 15, 765–776.

*Assesses the different methods that can be used to determine the genetic contribution or heritability of a trait or disease.*

### ELEMENTS

- 1 The concept of multifactorial inheritance has been proposed to account for the common congenital malformations and acquired disorders that show non-Mendelian familial aggregation. These disorders are thought to result from the interaction of genetic and environmental factors.
- 2 Human characteristics such as height and intelligence, which show a normally distributed continuous distribution in the general population, are probably caused by the additive effects of many genes (i.e. polygenic inheritance).
- 3 According to the liability/threshold model for multifactorial inheritance, the population's genetic and environmental susceptibility, which is known as liability, is normally distributed. Individuals are affected if their liability exceeds a threshold superimposed on the liability curve.
- 4 Recurrence risks to relatives for multifactorial disorders are influenced by the disease severity, the degree of relationship to the index case, the number of affected close relatives and, if there is a higher incidence in one particular sex, the sex of the index case.
- 5 Heritability is a measure of the proportion of the total variance of a character or disease that is due to the genetic variance. Heritability is best calculated in twin and family studies.
- 6 Thousands of genetic susceptibility loci for multiple common diseases have been identified. Major progress has been enabled in recent years by genome-wide association studies revealing new biological pathways involved in disease pathogenesis and leading to future therapeutic advances.

# Screening for Genetic Disease

Genetic disease may affect individuals and their families dramatically, nonetheless, every person and every couple having children is at some risk of seeing a disorder with a genetic component suddenly appear. Our concepts and approaches to screening reflect the different burdens that these two realities impose. First, there is screening of individuals and couples known to be at significant or high risk because of a positive family history—sometimes referred to as **targeted** or **family screening**. This includes **carrier**, or **heterozygote**, **screening**, as well as **presymptomatic testing**. Second, there is the screening offered to the general population, who are at low risk—sometimes referred to as **community genetics**—and very much within the remit of public health. Population screening involves the offer of genetic testing on an equitable basis to all relevant individuals in a defined population. The objectives are the prevention of morbidity and suffering resulting from genetic disease, and to enhance individual autonomy through better information about genetic risks and reproductive options.

## Screening Those at High Risk

Here we focus on the very wide range of general genetic disease as opposed to screening in the field of cancer genetics, which is addressed in [Chapter 14](#). Prenatal screening is also covered in more detail in [Chapter 20](#). If it were easy to recognize carriers of autosomal and X-linked recessive disorders, and persons who are heterozygous for autosomal dominant disorders that show reduced penetrance or a late age of onset, much doubt and uncertainty would be removed when providing information in genetic counseling. Increasingly, mutation analysis in genes that cause these disorders is indeed making the task easier. Where this is not possible, either because no gene test is available or the molecular pathology is elusive in a gene known to be associated with the disorder in question, a number of strategies are available to detect carriers for autosomal and X-linked recessive disorders, and for presymptomatic diagnosis of heterozygotes for autosomal dominant disorders.

## Carrier Testing for Autosomal Recessive and X-Linked Disorders

In a number of autosomal recessive disorders, such as some of the inborn errors of metabolism (e.g., Tay-Sachs disease; [p. 264](#)) and the hemoglobinopathies (e.g., sickle cell disease; [p. 158](#)), carriers can be recognized with a high degree of certainty using biochemical or hematological techniques, and DNA analysis is often not necessary. In other single-gene disorders, it is possible to detect or confirm carrier status by biochemical means in only a proportion of carriers; for example, mildly abnormal coagulation study results in a woman at risk of being a carrier for hemophilia ([p. 300](#)). A significant proportion of obligate carriers of hemophilia will have normal

coagulation, however, so a normal result does not exclude a woman at risk from being a carrier.

There are several possible ways in which carriers of genetic diseases can be recognized.

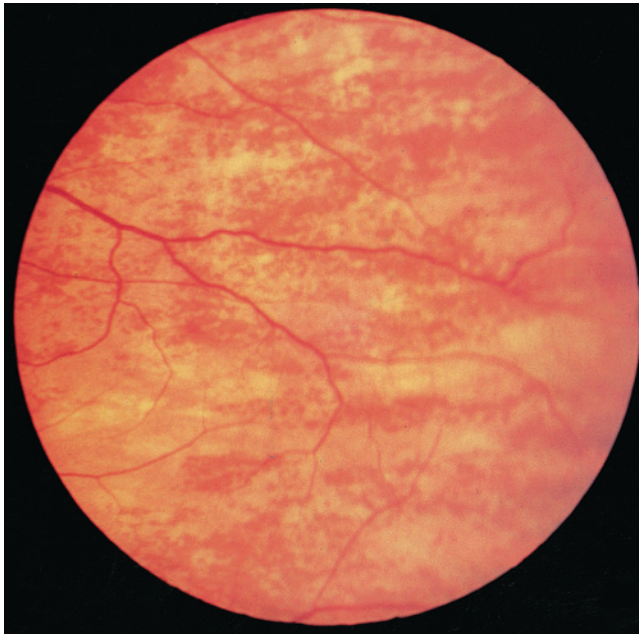
### Clinical Manifestations in Carriers

Occasionally, carriers for certain disorders can have mild clinical manifestations of the disease ([Table 11.1](#)), particularly with some of the X-linked disorders. These manifestations are usually so slight that they are apparent only on careful clinical examination; for instance, the mosaic pattern of retinal pigmentation seen in manifesting female carriers of X-linked ocular albinism ([Figure 11.1](#)), or the characteristic lens opacities seen in Fabry disease. Such manifestations, even though minimal, are often very reliable, though they are the exception rather than the rule, and in most autosomal and X-linked recessive disorders there are either no manifestations in carriers, or they overlap with the variation seen in the general population.

**Table 11.1** Clinical and Biochemical Abnormalities in Carriers of X-Linked Disorders\*

Disorder	Abnormality
<i>Clinical</i>	
Ocular albinism	Mosaic retinal pigmentary pattern
Retinitis pigmentosa	Mosaic retinal pigmentation, abnormal electroretinographic findings
Anhidrotic ectodermal dysplasia	Sweat pore counts reduced, dental anomalies
Lowe syndrome	Lens opacities
Alport syndrome	Hematuria
<i>Biochemical</i>	
Hemophilia A	Reduced factor VIII activity : antigen ratio
Hemophilia B	Reduced levels of factor IX
Glucose 6-phosphate dehydrogenase (G6PD) deficiency	Erythrocyte G6PD activity reduced
Lesch-Nyhan syndrome fibroblasts	Reduced hypoxanthine-guanine phosphoribosyl transferase activity in skin
Hunter syndrome	Reduced sulfiduronate sulfatase activity in skin fibroblasts
Vitamin D-resistant rickets	Serum phosphate level reduced
Duchenne muscular dystrophy	Raised serum creatine kinase level
Becker muscular dystrophy	Raised serum creatine kinase level
Fabry disease	Corneal and lens opacities

\*In many cases these methods have been superseded by direct gene tests.



**FIGURE 11.1** The fundus of a carrier of X-linked ocular albinism showing a mosaic pattern of retinal pigmentation. (Courtesy Mr. S.J. Charles, The Royal Eye Hospital, Manchester, UK.)

An example would be female carriers of hemophilia, who have a tendency to bruise easily; this is not a reliable sign of carrier status as this is relatively common in the general population for other reasons. In X-linked adrenoleukodystrophy, a proportion of female carriers manifest neurological features, sometimes relatively late in life when the signs might easily be confused with the problems of aging.

### Biochemical Abnormalities in Carriers

Historically, the demonstration of detectable biochemical abnormalities in carriers of certain diseases has been important. In some cases the biochemical abnormality is a direct product of the gene and the carrier status can be tested for with confidence. For example, in carriers of Tay-Sachs disease the range of enzyme activity (**hexosaminidase**) is intermediate between levels found in normal and affected people. Carrier testing for Tay-Sachs disease in many orthodox Jewish communities, which are at significantly increased risk of the disorder, is highly developed. Because of faith-based objections to termination of pregnancy, carrier testing may be crucial in the selection of life partners. A couple considering betrothal will first see their rabbi. In addition to receiving spiritual advice, they will undergo carrier testing for Tay-Sachs disease. If both prove to be carriers, the proposed engagement will be called off, leaving them free to look for a new partner. If only one proves to be a carrier the engagement can proceed, although the rabbi does not disclose which one is the carrier. Although such a strategy to prevent genetic disease would theoretically be possible in many communities where inbreeding is the norm, and their 'private' diseases have been well characterized either biochemically or by molecular genetics, in practice this is very rare.

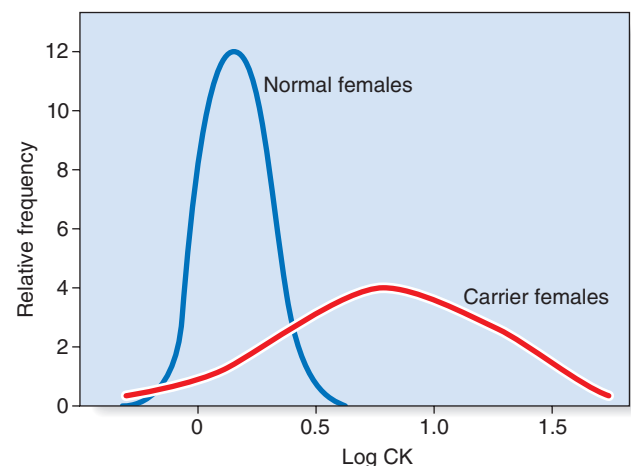
In many single-gene disorders, the biochemical abnormality used in the diagnosis of the disorder in the affected individual is not a direct result of action of the gene product but the consequence of a secondary or downstream process. Such abnormalities are further from the primary action of the gene

and, consequently, are usually much less likely to be useful in identifying carriers. For example, in Duchenne muscular dystrophy (DMD) there is an increased permeability of the muscle membrane, resulting in the escape of muscle enzymes into the blood. A grossly raised serum creatine kinase (CK) level often confirms the diagnosis of DMD in a boy presenting with features of the disorder (p. 281). Obligate female carriers of DMD have, on average, serum CK levels that are increased compared with those of the general female population (Figure 11.2) but there is substantial overlap of CK values between normal and obligate carrier females. Nevertheless, where DNA is not available from an affected male for dystrophin gene mutation analysis, this information can be used in conjunction with pedigree risk information (p. 98), and the results of linked DNA markers (p. 99), to help calculate the likelihood of a woman being a carrier for this disorder. Where linked markers are used, whether for DMD or another disease, it is essential that DNA samples are available from key family members, both affected and unaffected, and the chance of recombination between the marker(s) and the locus is taken into account. Also, the markers used need to be sufficiently polymorphic to be **informative** in the family being investigated, and locus, or genetic, heterogeneity (where the disease phenotype may be associated with mutations in more than one gene) should not be an issue.

The other reason for difficulty with carrier testing in X-linked recessive disorders is random inactivation of the X chromosome in females (p. 122), which often renders biochemical methods unreliable. An exception to this involves analysis of individual *clones* to look for evidence of two populations of cells, as with peripheral blood lymphocytes in female carriers of some of the X-linked immunodeficiency syndromes (p. 174), usually referred to as 'X-inactivation studies'.

### Presymptomatic Diagnosis of Autosomal Dominant Disorders

Many autosomal dominant single-gene disorders either have a delayed age of onset (p. 96) or exhibit reduced penetrance (p. 95). The results of clinical examination, specialist



**FIGURE 11.2** Creatine kinase (CK) levels in obligate carrier females of Duchenne muscular dystrophy and women from the general population. (Adapted from Tippett PA, Dennis NR, Machin D, et al 1982 Creatine kinase activity in the detection of carriers of Duchenne muscular dystrophy: comparison of two methods. *Clin Chim Acta* 121:345–359.)

investigations, biochemical studies, and family DNA studies can enable the genetic status of the person at risk to be determined before the onset of symptoms or signs. This is known as **presymptomatic**, or **predictive**, testing.

### Clinical Examination

In some dominantly inherited disorders, simple clinical means can be used for presymptomatic diagnosis, taking into account possible pleiotropic effects of a gene (p. 66). For example, individuals with neurofibromatosis type I (NF1) can have a variety of clinical features (p. 279). It is not unusual to examine an apparently unaffected relative of someone with NF1, who has had no medical problems, only to discover that they have sufficient numbers of café-au-lait spots or cutaneous **neurofibromas** to confirm that they are affected. However, NF1 is a relatively rare example of a dominantly inherited disorder that is virtually 100% penetrant by the age of 5 or 6 years, with visible external features. With many other disorders, clinical examination is less helpful.

In tuberous sclerosis (TSC) a number of body systems may be involved and the external manifestations, such as the facial rash of angiokeratoma (Chapter 6; see Figure 6.5A, p. 68) may not be present. Similarly, seizures and learning difficulties are not inevitable. In autosomal dominant polycystic kidney disease, which is extremely variable and may have a delayed age of onset, there may be no suspicion of the condition from routine examination, and hypertension may be borderline without raising suspicions of an underlying problem. Reaching a diagnosis in Marfan syndrome (p. 291) can be difficult because of the variable features and overlap with other joint hypermobility disorders, even though very detailed diagnostic criteria have been established. However, other inherited cardiac conditions, such as the cardiomyopathies or familial arrhythmias (e.g. long QT and Brugada syndromes) present very significant challenges (Chapter 19). These conditions are clinically variable with reduced penetrance, are genetically very heterogeneous, and in a proportion of cases are due to digenic inheritance (Chapter 6, p. 75)

### Specialist Investigation

In conditions where clinical assessment leaves diagnostic doubt or ambiguity, special investigations of relevant body systems can serve to clarify status and presymptomatic diagnosis. In TSC, imaging studies of the brain by computed tomography to look for intracranial calcification (Figure 11.3) are more or less routine, as well as renal ultrasonography to identify the cysts known as angiomyolipoma(ta) (Figure 11.4). Use of these relatively non-invasive tests in relatives of persons with TSC can often detect evidence of the condition in asymptomatic persons.

Similarly, assessment for Marfan syndrome involves ophthalmic examination for evidence of ectopia lentis, echocardiography for measurement of the aortic root diameter, and sometimes magnetic resonance imaging of the lumbar spine to look for evidence of dural ectasia—all of which are important criteria.

Absence of these findings on clinical examination or specialist investigation does not always exclude the diagnosis, however, though the likelihood of the person having inherited the faulty gene is reduced. Where positive findings are made, it is important to know how specific or pathognomonic they are, which together with pedigree risk information may help to calculate the residual likelihood of having inherited the faulty gene.

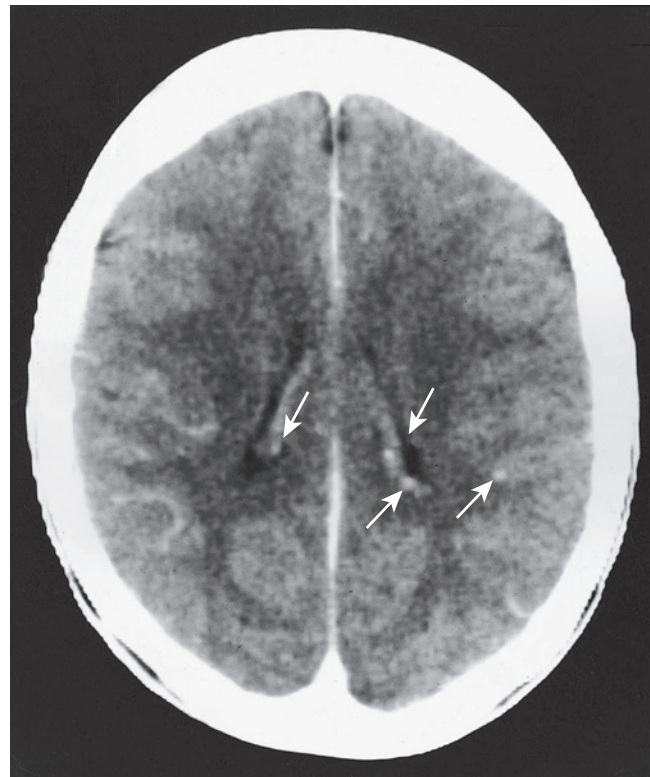


FIGURE 11.3 Intracranial calcification (arrows) in an asymptomatic person with tuberous sclerosis.

### Biochemical Tests

For a number of autosomal dominant disorders, biochemical tests can determine whether or not a person at risk has inherited a gene. Examples include the use of serum cholesterol levels in those at risk for familial hypercholesterolemia (p. 262), though genetic testing is increasingly being introduced, and

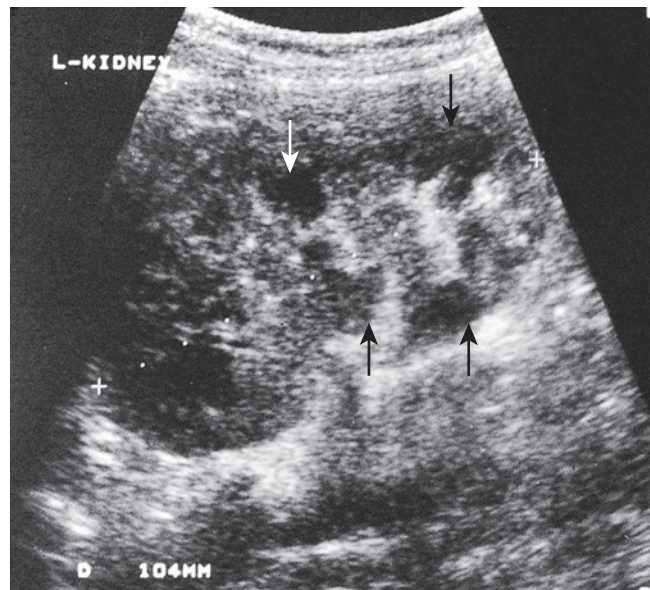


FIGURE 11.4 Renal ultrasonogram of an asymptomatic person with tuberous sclerosis showing abnormal echogenicity due to presumed angiomyolipomata (arrows).

assay of the appropriate urinary porphyrins or the specific enzyme deficiency in the various dominant porphyrias (p. 266).

### Direct Mutation Testing

Increasingly, as our knowledge of the human genome has grown, direct DNA mutation analysis is the investigation of choice to clarify the genetic status of individuals at risk of inherited conditions. In the large majority of clinical situations it is both desirable and necessary to identify a pathogenic mutation in an affected individual within a family. Where this is achieved with confidence presymptomatic testing can be offered to family members at risk, taking into account age-appropriateness and consent/autonomy issues relating to children and minors. A common pitfall faced in the outcome of testing, however, is the pathogenicity of many DNA findings such as missense variants and intronic changes, especially where they are novel and not previously listed in DNA databases. In these circumstances the help of bioinformatics tools can be crucial to determining whether a particular finding is clinically useful. [Box 11.1](#) lists some of the more common conditions in which DNA mutation analysis is regularly used to offer presymptomatic diagnosis, but there are of course many more.

### Ethical Considerations in Carrier Detection and Predictive Testing

Medically, there are often advantages in being able to determine the carrier status of a person at risk of an autosomal or X-linked recessive disorder, mainly relating to a couple being able to make an informed choice when having children. For some individuals and couples, however, the knowledge that there is a significant risk of having an affected child may present options and choices that they would rather not have. The attendant risk, and the awareness that prenatal diagnosis is available, may create a sense of guilt whichever decision is taken—either to have a child knowing it could be affected, or to have prenatal testing and possible termination of pregnancy. The latter option is especially difficult when the prognosis of the disease in question cannot be stated with any certainty because of variability or reduced penetrance, or if there is hope that treatment may be developed in time to help the child. Because of these difficulties and potential dilemmas it is normal practice to

suggest that information is passed on *within* families, rather than by professionals. In general this approach works well, but professional dilemmas can arise if family members refuse to communicate with one another when the disease in question carries significant morbidity and the risk may be high, particularly with X-linked conditions.

In those at risk for late-onset autosomal dominant disorders, many of which have neurological features, there can in some instances be a clear advantage in presymptomatic diagnosis. For example, in those at risk for familial adenomatous polyposis (p. 189), colonoscopy looking for the presence of colonic polyps can be offered as a regular screening procedure to those who have been shown to be at high risk of developing colonic cancer by molecular studies. Conversely, individuals who have not inherited a mutation in the *APC* gene do not need to be screened.

In contrast, for persons at risk for Huntington disease (HD), in which there is not yet any effective treatment to delay the onset or progression of the disorder, the benefit of predictive testing is not immediately obvious. The same is true for familial forms of Alzheimer disease, motor neurone disease, cerebral autosomal dominant arteriopathy with subcortical infarcts and leukoencephalopathy (CADASIL), and the spinocerebellar ataxias. Although choice is often considered to be of paramount importance in genetic counseling for those at risk for inherited disorders, it is important to remember that those considering presymptomatic or predictive testing should proceed only if they can give truly informed consent and are free from coercion from any outside influence. It is possible that employers, life insurance companies, and society in general will put indirect, and on occasion, direct pressure on those at high at risk to be tested (p. 327). Indeed, there are examples in which individuals at risk of HD have received prejudicial treatment in relation to employment, and higher than average insurance premiums can be expected on the basis of the family history alone. A significant problem raised by predictive testing for late-onset disorders is that it can, in theory, be used for children and minors. This issue can be very contentious, with parents sometimes arguing that it is their right to know the status of their child(ren). However, this conflicts with the high ideal of upholding the principle of individual autonomy wherever possible. Presymptomatic testing of children is therefore usually discouraged unless an early medical intervention or screening is beneficial for the disorder, which is certainly true for a number of the familial cancer conditions. The issue of genetic testing of children is addressed more fully in [Chapter 22](#) (p. 326).

#### Box 11.1 Autosomal Disorders That Show a Delayed Age of Onset, or Exhibit Reduced Penetrance, for Which Mutational Analysis (or Occasionally Linked Markers) Can Be Used to Offer Presymptomatic Testing

- Breast cancer
- Familial adenomatous polyposis
- Hereditary motor and sensory neuropathy type I
- Hereditary non-polyposis colonic cancer
- Huntington disease
- Inherited cardiac arrhythmias
- Marfan syndrome
- Myotonic dystrophy
- Neurofibromatosis type I
- Neurofibromatosis type II
- Tuberous sclerosis
- Von Hippel–Lindau disease

### Population Screening

One definition of population screening is: ‘The systematic application of a test or inquiry, to identify individuals at sufficient risk of a specific disorder to warrant further investigation or treatment, amongst persons who have not sought medical attention on account of symptoms of that disorder’. Neonatal screening for phenylketonuria is the paradigm of a good screening program and has been available since 1969 in the UK, with screening for congenital hypothyroidism from 1981. In the United Kingdom, since 1996, population screening has been overseen by the UK National Screening Committee (NSC), which advises the government. The current, nationally managed, screening programs are listed in [Box 11.2](#). The implementation of a screening program is a huge logistical exercise requiring financial and statistical expertise, and technology resources, as

### Box 11.2 Current Nationally Managed Screening Programs in the UK (With Genetic or Potentially Genetic Causes)

#### Antenatal

Down syndrome  
Sickle cell disease  
Thalassemia  
Structural abnormalities (fetal anomaly scanning at 18–20 weeks' gestation)

#### Newborn Bloodspot

Phenylketonuria (PKU)  
Congenital hypothyroidism (CHT)  
Sickle cell disease (SCD)  
Cystic fibrosis (CF)  
Medium chain acyl-CoA dehydrogenase deficiency (MCADD)  
Maple syrup urine disease (MSUD)  
Isovaleric acidemia (IVA)  
Glutaric aciduria type 1 (GA1)  
Homocystinuria (HCU)

#### Newborn and Infant Physical Examination

Newborn hearing

#### Adult

Breast cancer (women >50y)  
Bowel cancer (>60y, fecal occult blood)  
Sight-threatening diabetic retinopathy  
Abdominal aortic aneurysm (men >65y)

well as setting up practical mechanisms to introduce the program and monitor outcomes and quality assurance.

### Criteria for a Screening Program

These can be considered under the headings of the disease, the test, and the practical aspects of the program (Box 11.3). These criteria apply equally to prenatal screening, which is addressed in Chapter 20.

#### The Disease

To justify the applied effort and resources allocated to screening, the disease should be sufficiently common and have potentially serious effects that are amenable to prevention or amelioration. This may involve early treatment, as in phenylketonuria diagnosed in the neonatal period (p. 255), or the offer of termination of pregnancy for disorders that cannot be

### Box 11.3 Criteria for a Screening Program

#### Disease

High incidence in target population  
Serious effect on health  
Treatable or preventable

#### Test

Non-invasive and easily carried out  
Accurate and reliable (high sensitivity and specificity)  
Inexpensive

#### Program

Widespread and equitable availability  
Voluntary participation  
Acceptable to the target population  
Full information and counseling provided

Table 11.2 Sensitivity and Specificity

	Disease Status	
	Affected	Unaffected
<i>Screening Test Result</i>		
Positive	a (true positive)	b (false positive)
Negative	c (false negative)	d (true negative)
Sensitivity: $a/(a + c)$ – proportion of true positives		
Specificity: $d/(d + b)$ – proportion of true negatives		

treated effectively and are associated with serious morbidity and/or mortality.

#### The Test

The test should be accurate and reliable with high **sensitivity** and **specificity**. Sensitivity refers to the proportion of cases that are detected. A measure of sensitivity can be made by determining the proportion of false-negative results (i.e., how many cases are missed). Thus, if a test detects only 70 of 100 cases, it shows a sensitivity of 70%. Specificity refers to the extent to which the test detects *only affected* individuals. If unaffected people test positive, these are referred to as false positives. Thus, if 10 of 100 unaffected individuals have a false-positive test result, the test shows a **specificity** of 90%. Table 11.2 explains this further. Of great interest too is the **positive predictive value** of a screening test, which is the proportion of positive tests that are true positives; this is illustrated in Table 11.3.

#### The Program

The program should be offered in a fair and equitable manner, and should be widely available. It must also be morally acceptable to a substantial proportion of the population to which it is offered. Participation must be entirely voluntary in the case of prenatal programs, but the ethical principles are more complex in neonatal screening for conditions where early treatment is essential and effective in preventing morbidity. In these situations, the principles of **beneficence** (doing good) and **non-maleficence** (not doing harm) are relevant. Easily understood information and well-informed counseling should both be readily available.

It is often stated that the cost of a screening program should be reasonable and affordable. This does not mean that the potential savings gained through a reduction in the number of affected cases requiring treatment should exceed or even balance the cost of screening. The incidence of several conditions screened for in the UK, based on data from 2005–2011, is shown in Table 11.4. Financial considerations can never be

Table 11.3 In This Hypothetical Scenario a Screening Test for Congenital Adrenal Hyperplasia (CAH) Has Been Implemented, With the Following Results

CAH Present		CAH Absent	
Positive	Negative	Positive	Negative
96	4	4980	510,100
Positive predictive value: $96/(96 + 4980) \cong 2\%$			
Sensitivity: $96/(96 + 4) = 96\%$			
Specificity: $510,100/(510,100 + 4980) \cong 99\%$			

**Table 11.4** Incidence of Conditions in the UK Detected by Newborn Bloodspot Screening (NBS), Based on 6 Million Births 2005–2011

Phenylketonuria (PKU)	1:10,000
Congenital hypothyroidism (CHT)	1:3,000
Medium chain Acyl CoA dehydrogenase deficiency (MCADD)	1:10,000
Cystic fibrosis (CF)	1:2,500
Sickle cell disease (SCD)	1:2,400

ignored but cost–benefit analyses must also take into account non-tangible factors such as the emotional costs of human suffering borne by both the affected individuals and those who care for them.

### Prenatal and Postnatal Screening

In the UK the NSC has overseen the establishment of a comprehensive program of screening through pregnancy and the neonatal period (see Figure 11.5), and to a greater or lesser extent similar programs are in place elsewhere in the world where public healthcare systems exist. This comprises fetal anomaly screening, Newborn Bloodspot Screening (NBS), the newborn and infant physical examination, and newborn hearing. In addition, the NHS Sickle Cell and Thalassaemia screening program is available both prenatally, aimed at identifying mothers and parents who are carriers for sickle cell, thalassaemia and other hemoglobin disorders, and as part of the NBS for sickle cell and  $\beta$ -thalassaemia major. This program is backed up by an educational resource called Professional Education for Genetic Assessment and Screening (PEGASUS), aimed at training in basic genetics using recessively inherited hemoglobinopathies as the model. Screening is constantly evolving and, for example, the early detection of ‘critical’ congenital heart disease by pulse oximetry is likely to be introduced in the near future.

### Fetal Anomaly Screening

Aspects of prenatal screening and testing are covered in more detail in Chapter 20. Fetal anomaly screening essentially consists of the *combined test*, optimally performed between 11<sup>+</sup>2 to 14<sup>+</sup>1 weeks of pregnancy, aimed mainly at the detection of Down syndrome but also trisomies 13 and 18, and has four components: maternal age, the nuchal translucency measurement, free beta human chorionic gonadotropin, and pregnancy associated plasma protein A. Subsequently, the program consists of ultrasound scanning of the fetus sometime between 18<sup>+</sup>0 and 20<sup>+</sup>6 weeks’ gestation.

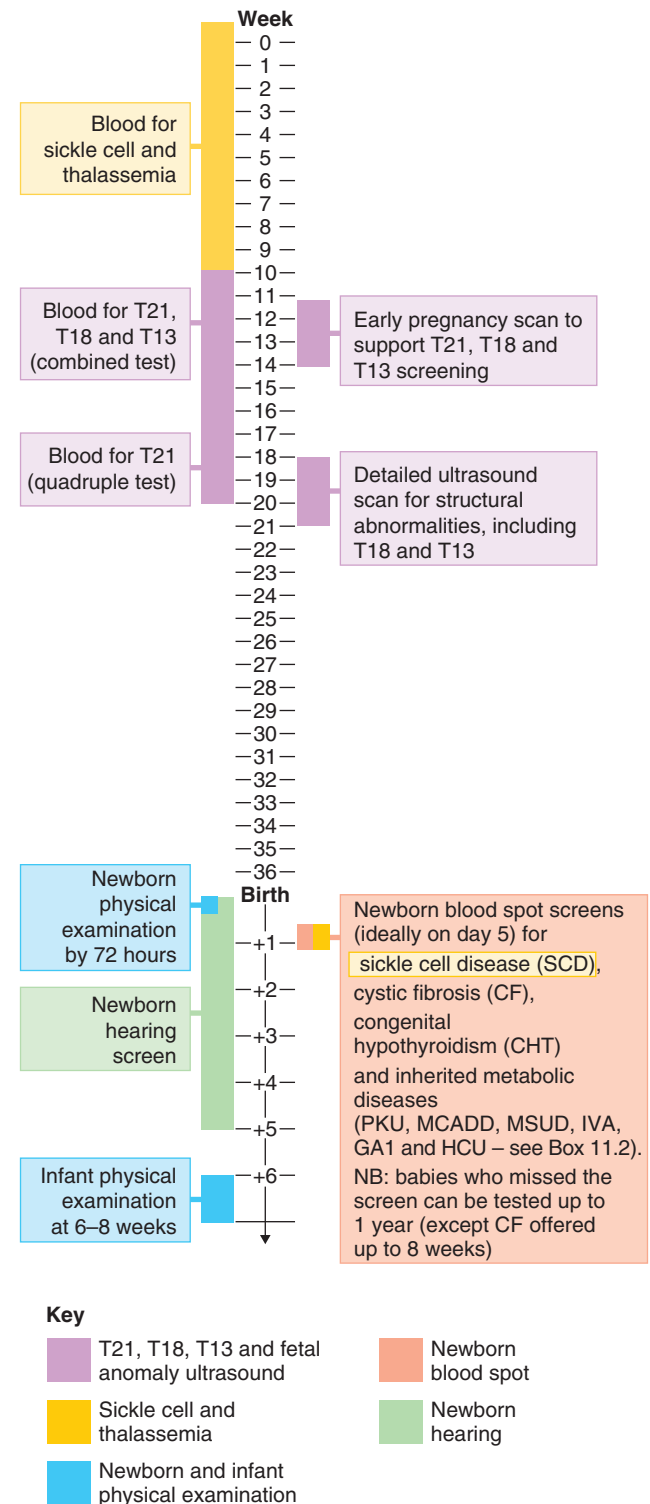
### Newborn Screening

#### Clinical Examination

A competent and thorough clinical examination of the newborn infant within 2–3 days of birth is a fundamental screening episode and should be performed by a trained clinician or health visitor who is familiar with the normal range. To miss developmental dysplasia of the hip at this stage and not embark on treatment, for example, may have lifelong disabling consequences. Follow-up examinations are usually performed by health visitors, who refer to a pediatrician if they have concerns about developmental progress or hearing, vision, and vocalization/speech.

### Newborn Bloodspot Screening

This methodology is indebted to Robert Guthrie, an American microbiologist, whose niece was diagnosed with PKU in 1958. Using a bacterial inhibition assay he developed a method that could detect high levels of phenylalanine in blood shortly after a baby was born, which he pioneered from 1961. For this he introduced the filter paper on which blood spots could be easily



**FIGURE 11.5** Prenatal and postnatal screening timeline, indicating the key routine events.

collected and transported—still used today—and overcame commercial pressures to see his methods introduced at low cost. NBS programs have been extended significantly after being limited to phenylketonuria, galactosemia, and congenital hypothyroidism for many years, and the analytical methods vary, with tandem mass spectrometry greatly extending the range (Tables 11.4 and 11.5).

In the UK nine conditions are now screened, the most recently introduced in 2014 (see Box 11.2). For all these disorders early diagnosis leads either to treatment that essentially prevents the development of learning disability, or other interventions that prevent or ameliorate medical problems. Worldwide, there is significant variation in NBS programs with the USA leading the way. Here the 'Newborn Screening Saves Lives Act' was signed into law in 2007 with the intention of unifying and expanding the program nationwide. This is overseen by the Centers for Disease Prevention and Control and at least 29 conditions are screened in all states, and more than 50 in some. The list includes severe combined immunodeficiency as well as a wide range of metabolic disorders. Germany screens for 15 conditions, and across the Middle East and North Africa, where rates of consanguinity are high, there is wide variation. In Saudi Arabia, for example, NBS covers more than 10 disorders but this does not reach the whole population. In The Netherlands, newborn screening is voluntary with informed parental consent, though highly recommended. Generally speaking, screening is mandatory or consent is implied.

**Table 11.5** Some Conditions for Which Neonatal Screening Is Undertaken, and the Methods of Testing

Disorder	Test/Method
Phenylketonuria	Guthrie test* or tandem mass spectrometry
Congenital hypothyroidism	Thyroid-stimulating hormone (fluoroimmunoassay)
Biotinidase deficiency	Enzymatic assay (fluorescence measurement)
Galactosemia	Enzymatic assay (fluorescence measurement)
Maple syrup urine disease	Tandem mass spectrometry
Glutaric aciduria, type 1	Tandem mass spectrometry
Isovaleric acidemia	Tandem mass spectrometry
Medium chain acyl-CoA dehydrogenase-deficiency (MCADD)	Tandem mass spectrometry
Very long chain acyl-CoA dehydrogenase-deficiency (VLCAD)	Tandem mass spectrometry
Long chain 3-hydroxyacyl-CoA-dehydrogenase deficiency (LCHAD)	Tandem mass spectrometry
Congenital adrenal hyperplasia	17-Hydroxyprogesterone assay (fluoroimmunoassay)
Cystic fibrosis	Immunoreactive trypsin and DNA analysis
Duchenne muscular dystrophy	Creatine kinase
Sickle-cell disease	Hemoglobin electrophoresis

\*The Guthrie test is based on reversal of bacterial growth inhibition by a high level of phenylalanine.

The importance of adhering to the principle of screening for a disorder that needs to be treated early is illustrated by the Swedish experience of neonatal screening for  $\alpha_1$ -antitrypsin deficiency. In this condition neonatal complications occur in up to 10%, but for most cases the morbidity is seen in adult life, and the main message on diagnosing the disorder is avoidance of smoking. Between 1972 and 1974, 200,000 newborns were screened and follow-up studies showed that considerable anxiety was generated when the information was conveyed to parents, who perceived their children to be at risk of a serious, life-threatening disorder. The case of newborn screening for Duchenne muscular dystrophy also deviates from the screening paradigm because, thus far, no early intervention is helpful. Here, the parents (or mother) can be counseled before having *more* children and, in the wider family, identification of female carriers (of reproductive age) may be possible. However, parental reaction has not been uniformly favorable. The rationale of screening for the following conditions is well established.

### Phenylketonuria

This was introduced in the UK in 1969 after it had been shown (some 10 years earlier) that a low-phenylalanine diet could prevent the severe learning disabilities that previously had been a hallmark of this condition (p. 255). The bloodspot is obtained by heel-prick at approximately 6–7 days of age and an abnormal test result is followed by repeat analysis of phenylalanine levels in a venous blood sample. A low-phenylalanine diet is not particularly palatable but affected children can be persuaded to adhere to it until early adult life when it can be relaxed. However, because high phenylalanine levels are toxic to the developing brain, a woman with phenylketonuria who is contemplating pregnancy should adhere to a strict low-phenylalanine diet both before and during pregnancy (p. 227).

### Galactosemia

Classic galactosemia affects approximately 1 in 50,000 newborn infants and usually presents with vomiting, lethargy, and severe metabolic collapse within the first 2 or 3 weeks of life. Early introduction of appropriate dietary restriction can prevent the development of serious complications such as cataracts, liver failure, and learning disability. Newborn screening was based on a modification of Guthrie's early methods with subsequent confirmation by specific enzyme assay, but was discontinued in the UK around 2000 on the recommendation of the NSC, the rationale being that if present it will manifest within the first few days of life and should be clinically recognizable. However, it is included in the extended screening programs of some countries.

### Congenital Hypothyroidism

Screening was introduced in the United States in 1974, the UK in 1981, and is now widespread. The test is usually based on assay of **thyroid-stimulating hormone**. This disorder is particularly suitable for screening as it is relatively common, with an incidence of approximately 1 in 4000, and treatment with lifelong thyroxine replacement is extremely effective in preventing the severe developmental problems associated with the classic picture of 'cretinism'. The most common cause of congenital hypothyroidism is absence of the thyroid gland rather than an inborn error of metabolism (see Chapter 18). Congenital absence of the thyroid gland is usually not caused



by genetic factors but on rare occasion is part of a wider syndrome.

### Cystic Fibrosis

Newborn screening for cystic fibrosis (CF, p. 286) is particularly relevant for northern European countries with a high population carrier frequency and was introduced in England in 2006. It is based on the detection of a raised blood level of **immunoreactive trypsin**, which is a consequence of blockage of pancreatic ducts in utero, supplemented by DNA analysis. Early treatment with physiotherapy and antibiotics improves the long-term prognosis.

### Sickle Cell Disease and Thalassemia

Newborn screening based on **hemoglobin electrophoresis** is undertaken in many countries with a significant Afro-Caribbean community. As with CF, it is anticipated that early prophylaxis will reduce morbidity and mortality, and the long-term outlook. In the case of sickle cell disease, treatment involves the use of oral penicillin to reduce the risk of pneumococcal infection resulting from immune deficiency secondary to splenic infarction (p. 158). Even in Western countries with good medical facilities, a significant proportion of sickle cell homozygotes, possibly as many as 15%, die as a result of infection in early childhood. In the case of thalassemia, early diagnosis makes it possible to optimize transfusion regimens and iron-chelation therapy from an early stage. Neonatal screening programs for both of these hemoglobinopathies were implemented in the United Kingdom in 2005, with antenatal screening (the mother, followed by the father if necessary) also in place. In some low-risk areas there is a preference for antenatal screening to be targeted to high-risk couples after completion of an ethnicity questionnaire (p. 162).

### Newborn Hearing Screening

The acquisition of language skills is an early developmental process in postnatal life and crucially dependent on adequate hearing sense. Although individuals, and their community, with hearing impairment make the best of life opportunities, and should not be subject to discrimination, most would concur that good communication skills are very important through life. If hearing impairment is identified early then aids can be fitted. The assessment should be performed in the first month of life and consists of the automated otoacoustic emission (AOAE) test for well babies followed by the automated auditory brainstem response test where there is no clear AOAE response.

### Population Carrier Screening

Widespread screening for carriers of autosomal recessive disorders in high-incidence populations was first introduced for the hemoglobinopathies (see Chapter 12) and has been extended to several other disorders (Table 11.6). The rationale behind these programs is that carrier detection can be supported by genetic counseling so that carrier couples can be forewarned of the 1 in 4 risk that each of their children could be affected. The example of Tay-Sachs disease in orthodox Jewish communities has been discussed previously (p. 145) but this does not amount to 'population' screening.

Experience with the two common hemoglobinopathies, thalassemia and sickle cell disease, illustrates the extremes of success and failure that can result from well or poorly planned screening programs.

**Table 11.6** Autosomal Recessive Disorders Suitable for Population Carrier Screening

Disorder	Ethnic Group or Community	Test
$\alpha$ -Thalassemia	China and eastern Asia	Mean corpuscular hemoglobin and hemoglobin electrophoresis
$\beta$ -Thalassemia	Indian subcontinent and Mediterranean countries	Mean corpuscular hemoglobin and hemoglobin electrophoresis
Sickle cell disease	Afro-Caribbean	Sickle test and hemoglobin electrophoresis
Cystic fibrosis	Western European whites	Common mutation analysis
Tay-Sachs disease	Ashkenazi Jews	Hexosaminidase A

### Thalassemia

$\alpha$ -Thalassemia and  $\beta$ -thalassemia are caused by abnormal globin chain synthesis because of mutations involving the  $\alpha$ - and  $\beta$ -globin genes or their promoter regions (p. 159) and show autosomal recessive inheritance. They are very common in South-East Asia ( $\alpha$ -thalassemia), Cyprus and the Mediterranean region, Italy, and the Indian subcontinent ( $\beta$ -thalassemia).

In Cyprus in 1974 the birth incidence of  $\beta$ -thalassemia was 1 in 250 (carrier frequency 1 in 8). After the introduction of a comprehensive screening program to determine the carrier status of young adults, which had the support of the Greek Orthodox Church, the incidence of affected babies declined by more than 95% within 10 years. Similar programs in Greece and Italy have seen a drop in the incidence of affected homozygotes of more than 50%.

### Sickle Cell Disease

In contrast to the Cypriot response to  $\beta$ -thalassemia screening, early attempts to introduce sickle cell carrier detection in the black population of North America were disastrous. Information pamphlets tended to confuse the sickle cell carrier state, or trait, which is usually harmless, with the homozygous disease, which conveys significant morbidity (p. 158). Several US states passed legislation making sickle cell screening in black people mandatory, and carriers suffered discrimination by employers and insurance companies, resulting in screening programs being abandoned. This experience emphasizes the importance of ensuring voluntary participation and providing adequate and appropriate information and counseling. Later pilot studies in the United States and in Cuba have shown that individuals of Afro-Caribbean origin are perfectly receptive to well planned, non-directive sickle cell screening programs.

### Cystic Fibrosis

In the white population of the United Kingdom, the CF carrier frequency is approximately 1 in 25 and the Phe508del mutation accounts for 75% to 80% of all heterozygotes. Initial studies of attitudes to CF carrier detection yielded quite divergent results. A casual, written invitation generates a poor take-up response of approximately 10%, whereas personal contact during early pregnancy, whether mediated through general practice or the antenatal clinic, results in uptake rates

of more than 80%. Studies have been undertaken to explore attitudes to CF screening among specific groups, such as school leavers and women in early pregnancy.

Two approaches for screening pregnant women have been considered. The first is referred to as **two-step** and involves testing pregnant mothers at the antenatal clinic. Those who test positive for a common mutation (approximately 85% of all cystic fibrosis carriers) are informed of the result and invited to bring their partners for testing—hence ‘two-step’ testing. If both partners are found to be carriers, an offer of prenatal diagnosis is made. This approach has the advantage that all carriers detected are informed of their result and further family studies—**cascade screening**—can be initiated.

The second approach is referred to as **couple screening**, which involves testing both partners simultaneously and disclosing positive results only if both partners are found to be carriers. In this way much less anxiety is generated, but the opportunity for offering tests to the extended family when only one partner is a carrier is lost. The results of these studies suggested that the ‘two-step’ and ‘couple’ screening approaches were equally acceptable to pregnant women, with take-up rates of approximately 70%. However, there is no publicly available CF screening for adults in the UK and newborn screening is now established.

### Positive and Negative Aspects of Population Screening

Well-planned population screening enhances informed choice and offers the prospect of a significant reduction in the incidence of disabling genetic disorders. These potential advantages have to be weighed against the potential disadvantages that can arise from the overenthusiastic pursuit of a poorly planned or ill-judged screening program (Box 11.4). Experience to date indicates that in relatively small, well-informed groups, such as the Greek Cypriots and American Ashkenazi Jews, community screening is welcomed. When screening is offered to larger populations the outcome is less certain.

A 3-year follow-up of almost 750 individuals screened for CF carrier status in the United Kingdom revealed that a positive test result did not cause undue anxiety, although some carriers had a relatively poor perception of their own general health. A more worrying outcome was that almost 50% of the individuals tested could not accurately recall or interpret their results. This emphasizes the importance of pretest counseling

#### Box 11.4 Potential Advantages and Disadvantages of Population Genetic Screening

##### Advantages

Informed choice  
Improved understanding  
Early treatment when available  
Reduction in births of affected homozygotes

##### Disadvantages and hazards

Pressure to participate causing mistrust and suspicion  
Stigmatization of carriers (social, insurance, and employment)  
Irrational anxiety in carriers  
Inappropriate reassurance if test is not 100% sensitive

#### Box 11.5 Roles and Benefits of Genetic Registers

- To maintain a communication process between the family and the genetics center when necessary, thus providing information and long term support
- To link biological relatives in order to understand the genetic risks that may apply to individuals, and help coordinate predictive testing and prenatal testing when requested
- To offer carrier detection to relevant family members when age-appropriate (e.g. young women for X-linked disorders)
- To schedule the start (and continuation) of conventional screening investigations and multidisciplinary management when age-appropriate (e.g. inherited cardiac conditions)
- To rapidly identify individuals eligible for new or modified screening programs (e.g. in cancer genetics) and, increasingly, treatment
- To readily identify suitable patients for new research projects
- To contribute to national and international efforts to assemble information in the genomic era and thus determine the significance of DNA sequence data through good phenotyping

and the provision of accurate information that is easily processed and understood.

### Genetic Registers

Regional genetic centers maintain confidential patient information systems and **registers** of families and individuals according to specific disease groups. The main difference compared with conventional medical records is the linking of biological relatives—some affected, some unaffected, and others at risk. They greatly assist patient and family management and calls for their destruction at a given time after death will be vigorously resisted. Confidentiality and data security are of course paramount.

One important function of registers is the facility to rapidly identify patients eligible for new or modified screening programs and modalities when introduced, for example in cancer genetics (Chapter 14). Similarly, patients with specific diagnoses or phenotypes can be readily found for new research projects. The uses of genetic registers are listed in Box 11.5 and in the future it is anticipated there will be more amalgamation of register information, particularly with respect to the massive quantities of data generated through whole exome and whole genome sequencing, the significance of which will require good clinical phenotyping. This era is underway with large scale population projects such as ‘100,000 Genomes’ in England and the Human Variome Project.

#### FURTHER READING

Axworthy, D., Brock, D.J.H., Bobrow, M., Marteau, T.M., 1996. Psychological impact of population-based carrier testing for cystic fibrosis: 3-year follow-up. *Lancet* 347, 1443–1446.

*A review of the impact of carrier testing for cystic fibrosis on over 700 individuals.*

Baily, M.A., Murray, T.H. (Eds.), 2009. Ethics and newborn genetic screening: new technologies, new challenges. Johns Hopkins University Press, Baltimore.

*A multi-author volume with a focus on the health economics of newborn screening and distributive justice.*

Harper, P.S., 2010. Practical Genetic Counselling, seventh ed. Hodder Arnold, London.

*A very good starting point in almost every aspect of genetic counselling, including carrier testing.*

Marteau, T., Richards, M. (Eds.), 1996. The troubled helix. Cambridge University Press, Cambridge.

*Perspectives on the social and psychological implications of genetic testing and screening.*

Nuffield Council on Bioethics, 1993. Genetic screening: ethical issues.

Nuffield Council on Bioethics, London.

*This report remains a very helpful read even though technologies have progressed.*

## Websites

Centers for Disease Control and Prevention. Newborn Screening (<http://www.cdc.gov/newbornscreening/>).

*A source of information on newborn screening in the USA*

Hilary Burton, Sowmiya Moorthie, 2010. Expanded Newborn Screening. A review of the evidence. PHG Foundation, Cambridge (<http://www.phgfoundation.org/file/5502/>).

The Human Variome Project (<http://www.humanvariomeproject.org/>).

*Portal to the successor to the Human Genome Project*

UK National Screening Committee (<https://www.gov.uk/government/groups/uk-national-screening-committee-uk-nsc>).

*A source of up-to-date information on screening in the UK*

## ELEMENTS

- 1** Targeted or family screening in genetics concerns those who are at relatively high risk because of their family history. Direct gene testing is often possible but there remains a vital role for detailed clinical examination and specialist clinical investigations, such as biochemical tests and imaging.
- 2** Consideration should be given to the advantages and disadvantages of presymptomatic or predictive testing from both a practical and an ethical point of view.
- 3** Population screening involves the offer of genetic testing to all members of a particular population, with the objectives of preventing later ill-health and providing informed personal choice. A good screening test has a high sensitivity and specificity.
- 4** Participation should be voluntary and each program should be widely available, equitably distributed, acceptable to the target population, and supported by full information and counseling.
- 5** Prenatal screening is routinely available and based on ultrasound examination at approximately 12 and 20 weeks' gestation, as well as combined testing to refine the risk for aneuploidies such as Down syndrome, which may lead to the offer of amniocentesis for fetal karyotyping.
- 6** Newborn screening for phenylketonuria was introduced in the 1960s but has now expanded to incorporate a wide range of metabolic conditions as well as hearing testing.
- 7** Population screening programs for carriers of  $\beta$ -thalassaemia have resulted in a major fall in the incidence of births of affected homozygotes. This has provided the paradigm for the introduction of screening for other disorders with serious long-term morbidity.
- 8** Well-organized genetic registers provide an effective means of identifying individuals eligible for testing and screening when new programs or modalities are introduced.

# Hemoglobin and the Hemoglobinopathies

*Blood is a very special juice.*

JOHANN WOLFGANG VON GOETHE, IN *FAUST I* (1808)

At least a quarter of a million people are born in the world each year with one of the disorders of the structure or synthesis of hemoglobin (Hb)—the *hemoglobinopathies*. These disorders therefore have the greatest impact on morbidity and mortality of any single group of disorders following Mendelian inheritance and have served as a paradigm for our understanding of the pathology of inherited disease at the clinical, protein, and DNA levels. The mobility of modern society means that new communities with a high frequency of hemoglobinopathies have become established in countries whose indigenous populations have a low frequency. As they are a major public health concern many countries have introduced screening programs. In England and Wales, there are an estimated 600,000 healthy carriers of Hb variants.

To understand the various hemoglobinopathies and their clinical consequences, it is first necessary to consider the structure, function, and synthesis of Hb.

## Structure of Hb

Hb is the protein present in red blood cells that is responsible for oxygen transport. There are approximately 15 grams of Hb in every 100 mL of blood, making it amenable to analysis.

## Protein Analysis

In 1956, by fractionating the peptide products of digestion of human Hb with the proteolytic enzyme, trypsin, Ingram found 30 discrete peptide fragments. Trypsin cuts polypeptide chains at the amino acids arginine and lysine. Analysis of the 580 amino acids of human Hb had previously revealed a total of 60 arginine and lysine residues, suggesting that Hb was made up of two identical peptide chains with 30 arginine and lysine residues on each chain.

At about the same time, a family was reported in which two hemoglobin variants, HbS and Hb Hopkins II, were both present in some family members. Several members of the family who possessed both variants had children with normal Hb—offspring who were heterozygous for only one Hb variant, as well as offspring who, like their parents, were doubly heterozygous for the two Hb variants. These observations provided further evidence that at least two different genes were involved in the production of human Hb.

Soon after, the amino-terminal amino acid sequence of human Hb was determined and showed valine-leucine and valine-histidine sequences in equimolar proportions, with two moles of each of these sequences per mole of Hb. This was consistent with human Hb being made up of a tetramer

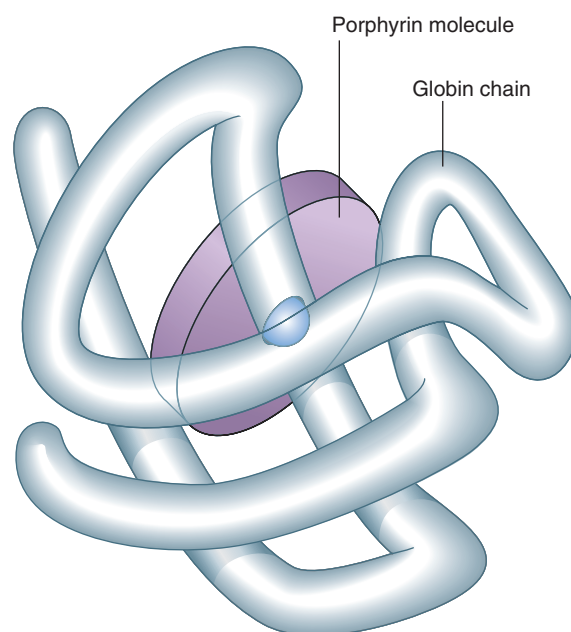
consisting of two pairs of different polypeptides, referred to as the  $\alpha$ - and  $\beta$ -globin chains.

Analysis of the iron content of human Hb revealed that iron constituted 0.35% of its weight, from which it was calculated that human Hb should have a minimum molecular weight of 16,000 Da. In contrast, determination of the molecular weight of human Hb by physical methods gave values of the order of 64,000 Da, consistent with the suggested *tetrameric* structure,  $\alpha_2\beta_2$ , with each of the globin chains having its own iron-containing group—*heme* (Figure 12.1).

Subsequent investigators demonstrated that Hb from normal adults also contained a minor fraction, constituting 2% to 3% of the total Hb, with an electrophoretic mobility different from the majority of human Hb. The main component was called HbA, whereas the minority component was called HbA<sub>2</sub>. Subsequent studies revealed HbA<sub>2</sub> to be a tetramer of two normal  $\alpha$  chains and two other polypeptide chains whose amino-acid sequence resembled most closely the  $\beta$  chain and was designated delta ( $\delta$ ).

## Developmental Expression of Hemoglobin

Analysis of Hb from a human fetus revealed it to consist primarily of an Hb with a different electrophoretic mobility from normal HbA, and was designated fetal Hb or HbF. Subsequent analysis showed HbF to be a tetramer of two  $\alpha$  chains and two



**FIGURE 12.1** Diagrammatic representation of one of the globin chains and associated porphyrin molecule of human hemoglobin.

Stage in Development	Hemoglobin	Structure	Proportion in Normal Adult (%)
Embryonic	Gower I	$\zeta_2\varepsilon_2$	—
	Gower II	$\alpha_2\varepsilon_2$	—
	Portland I	$\zeta_2\gamma_2$	—
Fetal	F	$\alpha_2\gamma_2$	<1
	A	$\alpha_2\beta_2$	97–98
Adult	A <sub>2</sub>	$\alpha_2\delta_2$	2–3

polypeptide chains whose sequence resembled the  $\beta$  chain and which were designated gamma ( $\gamma$ ). HbF makes up somewhere in the region of 0.5% of hemoglobin in the blood of normal adults.

Analysis of Hb from embryos earlier in gestation revealed a developmental, or ontological, succession of different embryonic Hbs: Hb Gower I and II, and Hb Portland, which are produced transiently in varying amounts at different gestational ages. These occur in tetramers of various combinations of  $\alpha$ , or  $\alpha$ -like, zeta ( $\zeta$ ) chains with  $\beta$ , or  $\beta$ -like,  $\gamma$ - and epsilon ( $\varepsilon$ ) chains (Table 12.1). Although both the  $\zeta$  chain and  $\varepsilon$  chain are expressed transiently in early embryonic life, the  $\alpha$  and  $\gamma$  chains are expressed throughout development, with increasing levels of expression of the  $\beta$  chain toward the end of fetal life (Figure 12.2).

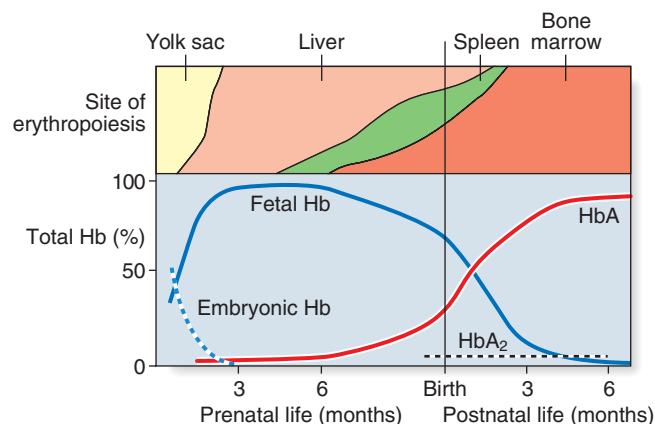
### Globin Chain Structure

Analysis of the structure of the individual globin chains was initially carried out at the protein level.

#### Protein Studies

Amino acid sequencing in the 1960s showed that the  $\alpha$  chain was 141 amino acids long compared with the  $\beta$  chain's 146 amino acids. Their sequences were similar but not identical. The  $\delta$  chain differs from the  $\beta$  chain by 10 amino acids, and analysis of the  $\gamma$  chain showed that it also most closely resembles the  $\beta$  chain, differing by 39 amino acids. In addition, two types of HbF were identified, in which the  $\gamma$  chain contains either the amino acid glycine or alanine at position 136, designated (G) $\gamma$  and (A) $\gamma$ , respectively. Partial sequence analyses of the  $\zeta$  and  $\varepsilon$  chains of embryonic Hb suggest that  $\zeta$  is similar in amino acid sequence to the  $\alpha$  chain, whereas  $\varepsilon$  resembles the  $\beta$  chain.

Thus, there are two groups of globin chains, the  $\alpha$ -like and  $\beta$ -like, possibly derived from an ancestral Hb gene that has changed over time.



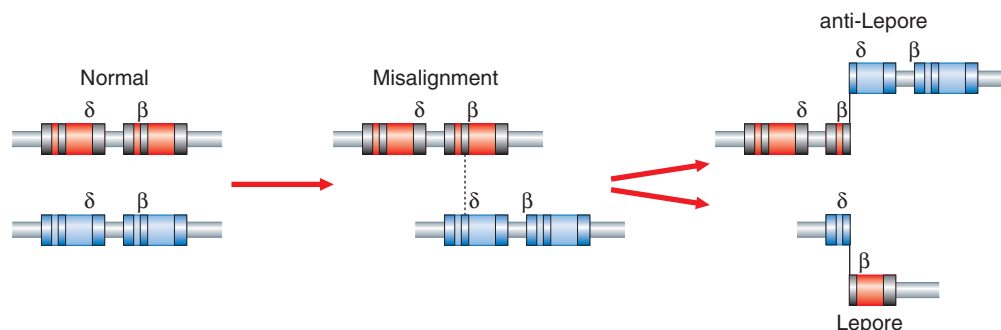
**FIGURE 12.2** Hemoglobin synthesis during prenatal and postnatal development. There are several embryonic hemoglobins. (After Huehns ER, Shooter EM 1965 *Human haemoglobins. J Med Genet* 2:48–90, with permission.)

### Globin Gene Mapping

Analysis of the Hb electrophoretic variant, Hb Lepore, helped our understanding of how globin genes are assembled on human chromosomes. Comparison of trypsin digests of Hb Lepore with normal Hb revealed normal  $\alpha$  chains, whereas the non- $\alpha$  chains consisted of an amino-terminal  $\delta$ -like sequence and a carboxy-terminal  $\beta$ -like sequence. This suggested Hb Lepore could represent a 'fusion' globin chain resulting from a crossover coincidental with mispairing of the  $\delta$ - and  $\beta$ -globin genes during meiosis because of sequence similarity of the two genes and their close proximity on the same chromosome (Figure 12.3). If correct, it was argued that there should also be an 'anti-Lepore' Hb—i.e., a  $\beta$ - $\delta$ -globin fusion product in which the non- $\alpha$ -globin chains contained  $\beta$ -chain residues at the amino-terminal end and  $\delta$ -chain residues at the carboxy-terminal end, as predicted.

Further evidence at the protein level for the physical mapping of globin genes came from another electrophoretic variant, Hb Kenya. Amino acid analysis suggested it was a  $\gamma$ - $\beta$  fusion product with a crossover having occurred somewhere between amino acids 81 and 86 in the two globin chains, which in turn suggested the  $\gamma$ -globin structural gene must also be in close physical proximity to the  $\beta$ -globin gene.

Little evidence was forthcoming from protein studies about the mapping of the  $\alpha$ -globin genes. The presence of normal



**FIGURE 12.3** Mechanism of unequal crossing over which generates Hb Lepore and anti-Lepore. (Adapted from Weatherall DJ, Clegg JB 1981 *The thalassaemia syndromes. Blackwell, Oxford.*)

HbA in individuals who, from family studies, should have been homozygous for a particular  $\alpha$  chain variant, or obligate compound (double) heterozygotes (p. 71), suggested there could be more than one  $\alpha$ -globin gene. In addition, the proportion of the total Hb made up by the  $\alpha$  chain variant in subjects heterozygous for those variants was consistently lower (<20%) than that seen with the  $\beta$  chain variants (usually >30%), suggesting there could be more than one  $\alpha$ -globin structural gene.

### Globin Gene Structure

The detailed structure of globin genes has been made possible by DNA analysis. Immature red blood cells, reticulocytes, provide a rich source of globin mRNA for the synthesis of cDNA—reticulocytes synthesize little else! Use of  $\beta$ -globin cDNA for restriction mapping studies of DNA from normal individuals revealed that the non- $\alpha$ , or  $\beta$ -like, globin genes are located in a 50-kilobase (kb) stretch on the short arm of chromosome 11 (Figure 12.4). The entire sequence of this 50-kb stretch containing the various globin structural genes is known. Of interest are non-functional regions with sequences similar to those of the globin structural genes—i.e., they produce no identifiable message or protein product and are pseudogenes.

Studies of the  $\alpha$ -globin structural genes have shown that there are two  $\alpha$ -globin structural genes— $\alpha_1$  and  $\alpha_2$ —located on chromosome 16p (see Figure 12.4). Sequencing has revealed nucleotide differences between these two genes even though the transcribed  $\alpha$ -globin chains have an identical amino acid sequence—considered as evidence for ‘degeneracy’ of the genetic code. In addition, there are pseudo- $\alpha$ , pseudo- $\zeta$ , and  $\zeta$  genes to the 5' side of the  $\alpha$ -globin genes, as well as an additional theta ( $\theta$ )-globin gene to the 3' side of the  $\alpha_1$ -globin gene. The  $\theta$ -globin gene, whose function is unknown, is interesting because, unlike the globin pseudogenes, which are not expressed, its structure is compatible with expression. It has been suggested that it could be expressed in very early erythroid tissue such as the fetal liver and yolk sac.

### Synthesis and Control of Hemoglobin Expression

Translation studies with reticulocyte mRNA has shown that  $\alpha$ - and  $\beta$ -globin chains are synthesized in roughly equal proportions. *In vitro* studies have shown, however, that  $\beta$ -globin mRNA is slightly more efficient in protein synthesis than  $\alpha$ -globin mRNA, and this difference is compensated for in red blood cell precursors by a relative excess of  $\alpha$ -globin mRNA. The most important level of regulation of expression of the

globin genes, as with other eukaryotic genes, appears to occur at the level of transcription (p. 14).

The timing and tissue-specific pattern of expression of globin genes in development is due to the **locus control region (lcr)**. In addition to promoter sequences in the 5' flanking regions of the various globin genes, there are sequences 6–20 kb 5' to the  $\epsilon$ -globin gene necessary for the expression of the various  $\beta$ -like globin genes, which constitute the lcr. This region regulates the **switching** of  $\beta$ -like globin genes. There is a similar region 5' to the  $\alpha$ -globin genes involved in the control of their expression, in both cases involved in the binding of proteins and transcription factors.

### Disorders of Hemoglobin

The disorders of human Hb can be divided into two main groups: (1) structural globin chain variants, such as sickle-cell disease, and (2) disorders of synthesis of the globin chains, the thalassemias.

#### Structural Variants/Disorders

In 1975, Ingram demonstrated that the difference between HbA and HbS lay in the substitution of valine for glutamic acid in the  $\beta$  chain. In 2001 the HbVar database was established at the Globin Gene Server (<http://globin.bx.psu.edu>) and more than 600 Hb electrophoretic variants have been described according to the type of mutation (Table 12.2). The majority are single amino acid substitutions resulting from a point mutation, are rare, and are not associated with clinical disease. A number are of course associated with disease and often relatively population-specific.

#### Types of Mutation

##### Point Mutation

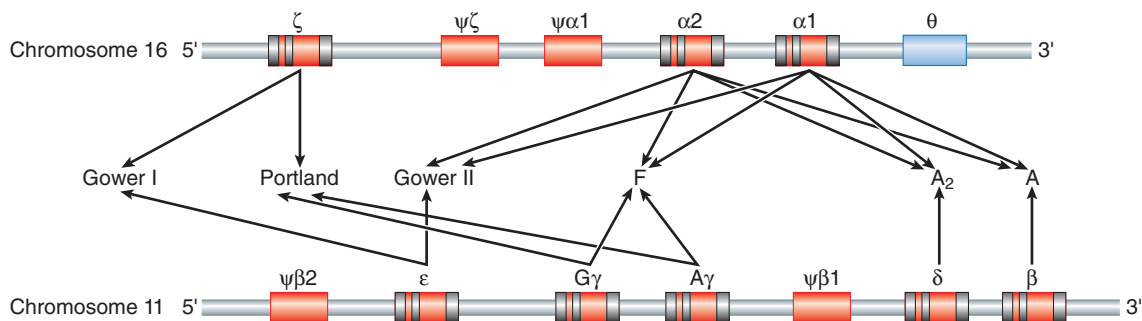
A point mutation that results in substitution of one amino acid for another can lead to altered hemoglobin, such as HbS, HbC, or HbE, which are missense mutations (p. 17).

##### Deletion

There are a number of Hb variants in which one or more amino acids of one of the globin chains are missing or deleted (p. 18) (e.g., Hb Freiburg).

##### Insertion

Conversely, there are variants in which the globin chains are longer than normal because of insertions (p. 18), such as Hb Grady.



**FIGURE 12.4** The  $\alpha$ - and  $\beta$ -globin regions on chromosomes 16 and 11 showing the structural genes and pseudogenes ( $\psi$ ) and the various hemoglobins produced. (Adapted from Carrell RW, Lehman H 1985 *The haemoglobinopathies*. In: Dawson AM, Besser G, Compston N eds. *Recent advances in medicine* 19, pp. 223–225. Churchill Livingstone, Edinburgh, UK.)

**Table 12.2** Structural Variants of Hemoglobin

Type of Mutation	Examples	Chain/Residue(s)/Alteration
Point (>200 variants)	HbS HbC HbE	$\beta$ , 6 glu to val $\beta$ , 6 glu to lys $\beta$ , 26 glu to lys
Deletion (shortened chain)	Hb Freiburg Hb Lyon Hb Leiden Hb Gun Hill	$\beta$ , 23 to 0 $\beta$ , 17–18 to 0 $\beta$ , 6 or 7 to 0 $\beta$ , 92–96 or 93–97 to 0
Insertion (elongated chain)	Hb Grady	$\alpha$ , 116–118 (glu, phe, thr) duplicated
Frameshift (insertion or deletion of multiples other than 3 base pairs)	Hb Tak, Hb Cranston Hb Wayne Hb McKees Rock	$\beta^*$ , +11 residues, loss of termination codon, insertion of 2 base pairs in codon 146/147 $\alpha^*$ , +5 residues, due to loss of termination codon by single base-pair deletion in codon 138/139 $\beta^*$ , –2 residues, point mutation in 145, generating premature termination codon
Chain termination	Hb Constant Spring	$\alpha^*$ , +31 residues, point mutation in termination codon
Fusion chain (unequal crossing over)	Hb Lepore/anti-Lepore Hb Kenya/anti-Kenya	Non- $\alpha$ , $\delta$ -like residues at N-terminal end and $\beta$ -like residues at C-terminal end, and vice versa, respectively Non- $\alpha$ , $\gamma$ -like residues at N-terminal end and $\beta$ -like residues at C-terminal end, and vice versa, respectively

\*Residues are either added (+) or lost (–).

### Frameshift Mutation

Frameshift mutations involve disruption of the normal triplet reading frame—i.e., the addition or removal of a number of bases that are not a multiple of three (p. 20). In this instance, translation of the mRNA continues until a termination codon is read ‘in frame’. These variants can result in either an elongated or a shortened globin chain.

### Chain Termination

A mutation in the termination codon itself can lead to an elongated globin chain (e.g., Hb Constant Spring).

### Fusion Polypeptides

Unequal crossover events in meiosis can lead to structural variants called **fusion polypeptides**, of which Hbs Lepore and Kenya are examples (p. 155).

### Clinical Aspects

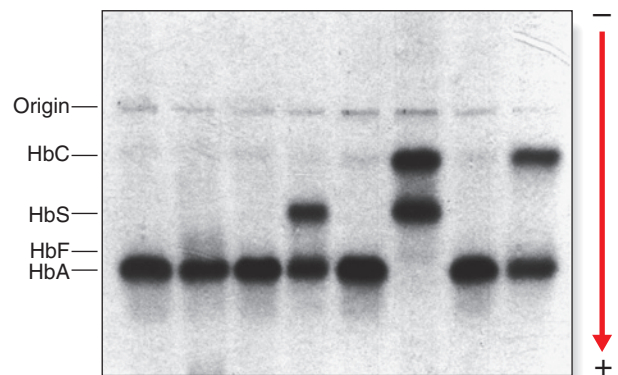
Some Hb variants are associated with disease—the more common shown in Table 12.3—but most are harmless, having been identified coincidentally in the course of population surveys.

If the mutation is on the inside of the globin subunits, in close proximity to the heme pockets, or at the interchain contact areas, this can produce an unstable Hb molecule that precipitates in the red blood cell, damaging the membrane and resulting in hemolysis of the cell. Alternatively, mutations can interfere with the normal oxygen transport function of Hb, leading to either enhanced, or reduced, oxygen affinity, or an Hb that is more stable in its reduced form, so-called **methemoglobin**.

The structural variants of Hb identified by *electrophoretic* techniques represent a minority of the total number of variants that exist, as it is predicted that only one-third of possible Hb mutations will produce an altered *charge* in the Hb molecule, and thereby be detectable by electrophoresis (Figure 12.5).

**Table 12.3** Functional Abnormalities of Structural Variants of Hemoglobin

Clinical Features	Examples
<b>Hemolytic Anemia</b> Sickling disorders	HbS/S, HbS/C disease, or HbS/O (Arab), HbS/D (Punjab), HbS/ $\beta$ -thalassemia, HbS/Lepore Other rare homozygous sickling mutations—HbS-Antilles, HbS-Oman
Unstable hemoglobin	Hb Köln Hb Gun Hill Hb Bristol
<b>Cyanosis</b> Hemoglobin M (methemoglobinemia) Low oxygen affinity	HbM (Boston) HbM (Hyde Park) Hb Kansas
<b>Polycythemia</b> High oxygen affinity	Hb Chesapeake Hb Heathrow



**FIGURE 12.5** Hemoglobin electrophoresis showing hemoglobins A, C, and S. (Courtesy Dr. D. Norfolk, General Infirmary, Leeds, UK.)

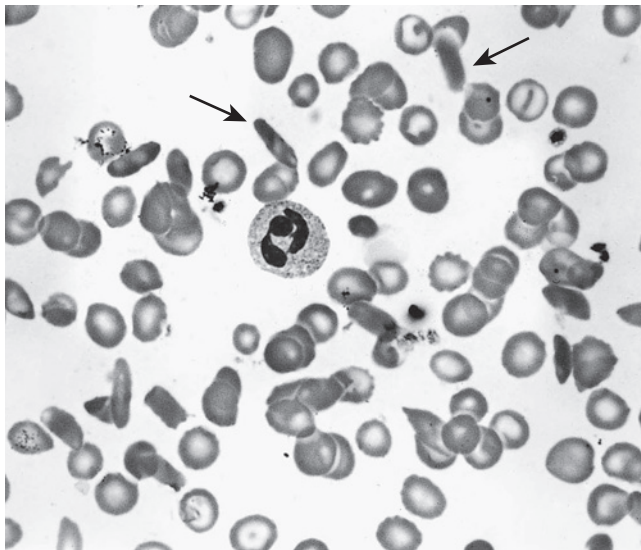


FIGURE 12.6 Blood film showing sickling of red cells in sickle-cell disease. Sickled cells are arrowed. (Courtesy Dr. D. Norfolk, General Infirmary, Leeds, UK.)

### Sickle Cell Disease

This severe hereditary hemolytic anemia was first recognized clinically early in the twentieth century, but in 1940 red blood cells from affected individuals with sickle cell (SC) disease were noted to appear birefringent when viewed in polarized light under the microscope, reflecting polymerization of the sickle hemoglobin. This distorts the shape of red blood corpuscles under deoxygenated conditions—so-called **sickling** (Figure 12.6). Linus Pauling, using electrophoresis in 1949, showed that it had different mobility to HbA and called it HbS, for sickle.

### Clinical Aspects of SC Disease

SC disease, following autosomal recessive inheritance, is the most common hemoglobinopathy, with some 9,500 sufferers in the UK. This is a prevalence, not an incidence, figure, and in England approximately 250,000 people are thought to be carriers (sickle cell trait), dominated by those of

African-Caribbean origin. The disease is especially prevalent in those areas of the world where malaria is endemic. The parasite *Plasmodium falciparum* is disadvantaged because the red cells of SC heterozygotes are believed to express malarial or altered self-antigens more effectively, resulting in more rapid removal of parasitized cells from the circulation. SC heterozygotes are therefore relatively protected from malarial attacks and biologically fitter, meaning the SC gene can be passed to the next generation. Over time this has resulted in relatively high gene frequency in malarial-infested regions (see Chapter 7).

Clinical manifestations include painful **sickle cell crisis**, chest crisis, aplastic crisis, splenic sequestration crisis, priapism, retinal disease, and cerebrovascular accident. Pulmonary hypertension may occur and heart failure can accompany severe anemia during aplastic or splenic sequestration crises. All these result from deformed, sickle-shaped red cells, which are less able to change shape and tend to obstruct small arteries, thus reducing oxygen supply to the tissues (Figure 12.7). Sickled cells, with damaged cell membranes, are taken up by the reticuloendothelial system. Shorter red cell survival time leads to a more rapid red cell turnover and, consequently, anemia.

Sickling crises reduce life expectancy, so early recognition and treatment of the complications are vital. Prophylactic penicillin to prevent the risk of overwhelming sepsis from splenic infarction has been successful and increased survival. The other beneficial approach is the use of **hydroxyurea**, a simple chemical compound that can be taken orally. Once-daily administration has been shown to increase levels of HbF through pharmacological induction. The HbF percentage has been shown to predict the clinical severity of SC disease, preventing intracellular sickling, which decreases vasoocclusion and hemolysis. It has been suggested that a potential threshold of 20% HbF is required to prevent recurrent vaso-occlusive events. Hydroxyurea is well-tolerated, safe, and has many features of an ideal drug. The US Food and Drug Administration approved hydroxyurea for adult patients with clinically severe sickle cell disease some years ago, but it has been used only sparingly.

### SC Trait

The heterozygous, or carrier, state for the SC allele is known as **sickle cell trait** and in general is not associated with any

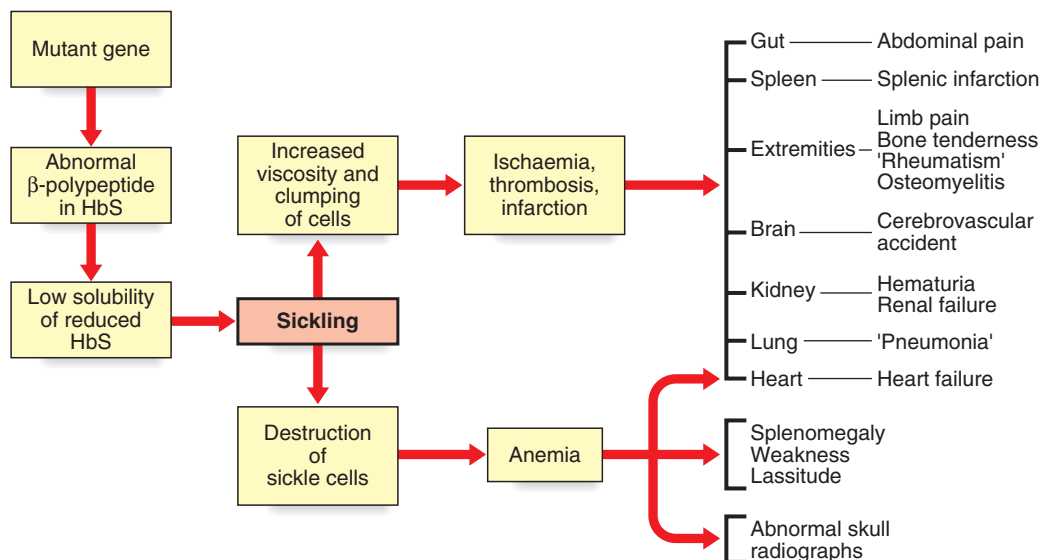


FIGURE 12.7 The pleiotropic effects of the gene for sickle-cell disease.



significant health risk. However, there may be a small increased risk of sudden death associated with strenuous exercise, possible risks from hypoxia on airplane flights, and anesthesia in pregnant women who are carriers.

### Mutational Basis of SC Disease

The amino acid valine, at the sixth position of the  $\beta$ -globin chain, is substituted by glutamic acid, the result of a missense change from  $GAG$  to  $GTC$ , which is readily detected by PCR. In the UK, as elsewhere, both antenatal and newborn screening programs are established to identify carriers (see [Chapter 11](#)).

### Disorders of Hemoglobin Synthesis

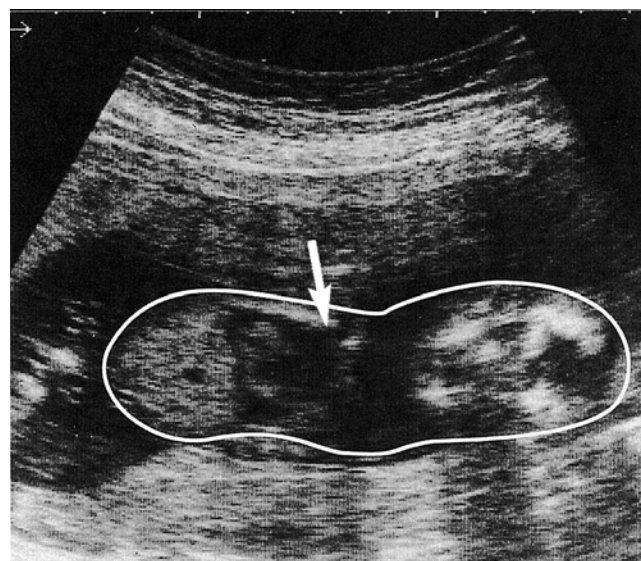
The **thalassemias** are the most common single group of inherited disorders in humans, occurring in persons from the Mediterranean region, Middle East, Indian subcontinent, and Southeast Asia. They are heterogeneous and classified according to the particular globin chain, or chains, synthesized in *reduced amounts* (e.g.,  $\alpha$ -,  $\beta$ -,  $\delta\beta$ -thalassemia). There are similarities in the pathophysiology of all forms of thalassemia, though excessive  $\alpha$  chains are more hemolytic than excessive  $\beta$  chains. An imbalance of globin-chain production results in the accumulation of free globin chains in the red blood cell precursors which, being insoluble, precipitate, resulting in hemolysis of red blood cells (i.e., a hemolytic anemia). The consequence is compensatory hyperplasia of the bone marrow.

#### $\alpha$ -Thalassemia

This results from underproduction of the  $\alpha$ -globin chains and occurs most commonly in Southeast Asia but is also prevalent in the Mediterranean, Middle East, India, and sub-Saharan Africa, with carrier frequencies ranging from 15% to 30%. There are two main types of  $\alpha$ -thalassemia: the severe form, in which no  $\alpha$  chains are produced, is associated with fetal death due to massive edema secondary to heart failure from severe anemia—*hydrops fetalis* ([Figure 12.8](#)). Analysis of Hb from such fetuses reveals a tetramer of  $\gamma$  chains, originally called Hb Barts. The milder forms of  $\alpha$ -thalassemia are compatible with survival, and although some  $\alpha$  chains are produced there is still a relative excess of  $\beta$  chains, resulting in production of the  $\beta$ -globin tetramer HbH—known as **HbH disease**. Both Hb Barts and HbH globin tetramers have an oxygen affinity similar to that of myoglobin and do not release oxygen as normal to peripheral tissues. Also, HbH is unstable and precipitates, resulting in hemolysis of red blood cells.

#### Mutational Basis of $\alpha$ -Thalassemia

The absence of  $\alpha$  chain synthesis in hydropic fetuses, and partial absence in HbH disease, was confirmed using quantitative mRNA studies from reticulocytes. Studies comparing the quantitative hybridization of radioactively labeled  $\alpha$ -globin cDNA to DNA from hydropic fetuses, and in HbH disease, were consistent with the  $\alpha$ -globin genes being deleted, which

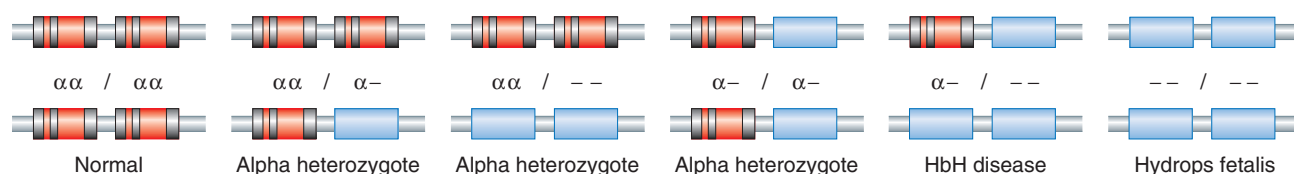


**FIGURE 12.8** Longitudinal ultrasonographic scan of a coronal section of the head (to the right) and thorax of a fetus with hydrops fetalis from the severe form of  $\alpha$ -thalassemia, Hb Barts, showing a large pleural effusion (arrow). (Courtesy Mr. J. Campbell, St. James's Hospital, Leeds, UK.)

by restriction mapping studies were localized to chromosome 16p. The various forms of  $\alpha$ -thalassemia are mostly the result of deletions of one or more of these structural genes ([Figure 12.9](#)), and deletions are thought to have arisen as a result of unequal crossover events in meiosis—more likely to occur where genes with homologous sequences are in close proximity. Support for this hypothesis comes from the finding of the other product of such an event (i.e., individuals with *three*  $\alpha$ -globin structural genes located on one chromosome).

These observations resulted in the recognition of two other milder forms of  $\alpha$ -thalassemia that are not associated with anemia and can be detected only by the *transient* presence of Hb Barts in newborns. Mapping studies of the  $\alpha$ -globin region showed that these milder forms of  $\alpha$ -thalassemia are due to the deletion of one or two of the  $\alpha$ -globin genes. Occasionally, non-deletion point mutations in the  $\alpha$ -globin genes, as well as the 5' transcriptional region, have been found to cause  $\alpha$ -thalassemia.

An exception to this classification of  $\alpha$ -thalassemias is the Hb variant Constant Spring, named after the town in the United States from which the original patient came. This was detected as an electrophoretic variant in a person with HbH disease. Hb Constant Spring is due to an abnormally long  $\alpha$  chain resulting from a mutation in the normal termination codon at position 142 in the  $\alpha$ -globin gene. Translation of  $\alpha$ -globin mRNA therefore continues until another termination codon is reached, resulting in an abnormally long  $\alpha$ -globin chain. The abnormal  $\alpha$ -globin mRNA molecule is also unstable,



**FIGURE 12.9** Structure of the normal and deleted  $\alpha$ -globin structural genes in the various forms of  $\alpha$ -thalassemia. (Adapted from Emery AEH 1984 *An introduction to recombinant DNA*. John Wiley, Chichester.)

leading to a relative deficiency of  $\alpha$  chains and the presence of the  $\beta$ -globin tetramer, HbH.

### $\beta$ -Thalassemia

By now the reader will deduce that this is caused by *underproduction* of the  $\beta$ -globin chain of Hb. Production of  $\beta$ -globin chains may be either reduced ( $\beta^+$ ) or absent ( $\beta^0$ ). Individuals homozygous for  $\beta^0$ -thalassemia mutations have severe, transfusion-dependent anemia. Approximately 1:1000 Northern Europeans are  $\beta$ -thalassemia carriers and in the United Kingdom some 20 babies with  $\beta^0$  thalassemia are born annually, and approximately 1000 people live with the condition. There are an estimated 214,000 carriers in England, mainly of Cypriot, Indian, Pakistani, Bangladeshi, or Chinese origins.

#### Mutational Basis of $\beta$ -Thalassemia

$\beta$ -Thalassemia is rarely the result of gene deletion and DNA sequencing is often necessary to determine the molecular pathology. In excess of 100 different mutations have been shown to cause  $\beta$ -thalassemia, including point mutations, insertions, and base-pair deletions. These occur within both the coding and non-coding portions of the  $\beta$ -globin genes as well as the 5' flanking promoter region, the 5' capping sequences (p. 15) and the 3' polyadenylation sequences (p. 15) (Figure 12.10). The various mutations are often unique to certain population groups and can be considered to fall into six main functional types.

**Transcription mutations.** Mutations in the 5' flanking TATA box or the promoter region of the  $\beta$ -globin gene can result in reduced transcription levels of the  $\beta$ -globin mRNA.

**mRNA splicing mutations.** Mutations involving the invariant 5' GT or 3' AG dinucleotides of the introns in the  $\beta$ -globin gene or the consensus donor or acceptor sequences (p. 15) result in abnormal splicing with consequent reduced levels of  $\beta$ -globin mRNA. The most common Mediterranean  $\beta$ -thalassemia mutation leads to the creation of a new acceptor AG dinucleotide splice site sequence in the first intron of the  $\beta$ -globin gene, creating a 'cryptic' splice site (p. 20). The cryptic splice site competes with the normal splice site, leading to reduced levels of the normal  $\beta$ -globin mRNA. Mutations in the coding regions of the  $\beta$ -globin region can also lead to cryptic splice sites.

**Polyadenylation signal mutations.** Mutations in the 3' end of the untranslated region of the  $\beta$ -globin gene can lead to loss of the signal for cleavage and polyadenylation of the  $\beta$ -globin gene transcript.

**RNA modification mutations.** Mutations in the 5' and 3' DNA sequences, involved respectively in the capping and polyadenylation (p. 15) of the mRNA, can result in abnormal processing and transportation of the  $\beta$ -globin mRNA to the cytoplasm, and therefore reduced levels of translation.

**Chain termination mutations.** Insertions, deletions, and point mutations can all generate a nonsense or chain termination codon, leading to premature termination of translation of the  $\beta$ -globin mRNA. Usually this results in a shortened  $\beta$ -globin mRNA that is unstable and more rapidly degraded leading to reduced levels of translation of an abnormal  $\beta$ -globin.

**Missense mutations.** Rarely, missense mutations lead to a highly unstable  $\beta$ -globin (e.g., Hb Indianapolis).

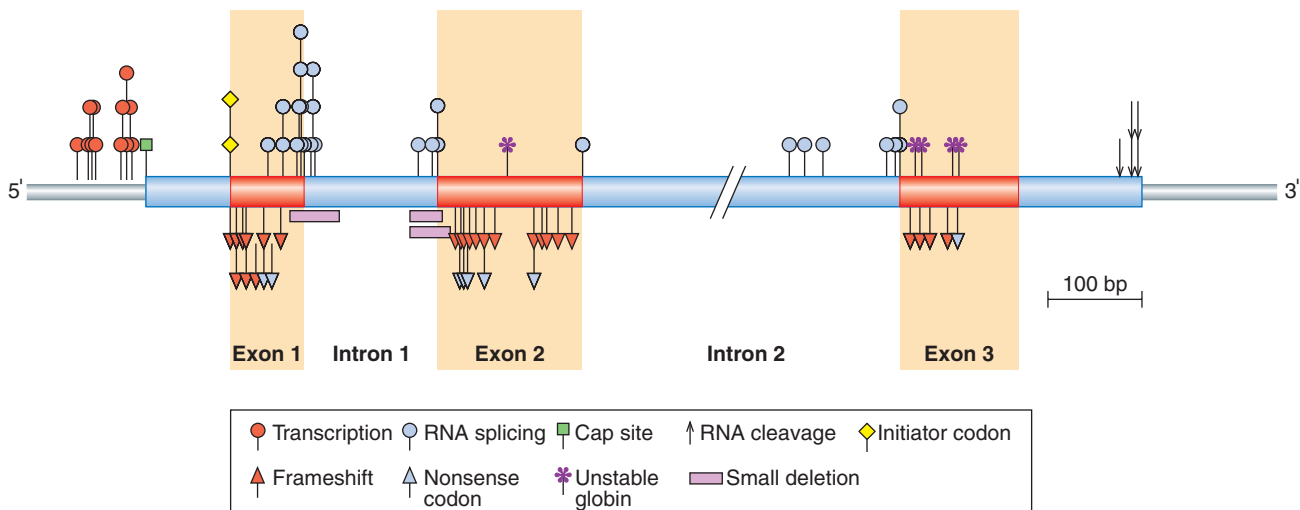
#### Clinical Aspects of $\beta$ -Thalassemia

Children with thalassemia major, or 'Cooley's anemia' as it was originally known, usually present in infancy with a severe transfusion-dependent anemia. Unless adequately transfused, compensatory expansion of the bone marrow results in an unusually shaped face and skull (Figure 12.11). Affected individuals typically died in their teens or early adulthood from complications resulting from iron overload from repeated transfusions. However, daily use of iron-chelating drugs, such as desferrioxamine, has greatly improved their long-term survival.

Individuals heterozygous for  $\beta$ -thalassemia—**thalassemia trait** or **thalassemia minor**—usually have no symptoms or signs but do have a mild hypochromic, microcytic anemia. This can easily be confused with simple iron deficiency anemia.

#### $\delta\beta$ -Thalassemia

In this hemoglobinopathy, there is underproduction of both the  $\delta$  and  $\beta$  chains. Homozygous individuals produce no  $\delta$ - or  $\beta$ -globin chains, which one might expect to cause a profound illness. However, they have only mild anemia because of increased production of  $\gamma$  chains, such that HbF levels are much



**FIGURE 12.10** Location and some of the types of mutation in the  $\beta$ -globin gene and flanking region that result in  $\beta$ -thalassemia. (Adapted from Orkin SH, Kazazian HH 1984 *The mutation and polymorphism of the human  $\beta$ -globin gene and its surrounding DNA*. *Annu Rev Genet* 18:131–171.)



**FIGURE 12.11** Facies of a child with  $\beta$ -thalassemia showing prominence of the forehead through changes in skull shape as a result of bone marrow hypertrophy. (Courtesy Dr. D. Norfolk, General Infirmary, Leeds, UK.)

higher compared with the mild compensatory increase seen in  $\beta^0$  thalassemia.

#### Mutational Basis of $\delta\beta$ -Thalassemia

The cause is extensive deletions in the  $\beta$ -globin region involving the  $\delta$ - and  $\beta$ -globin structural genes (Figure 12.12). Some large deletions include the  $A\gamma$ -globin gene so that only the  $G\gamma$ -globin chain is synthesized.

#### Hereditary Persistence of Fetal Hemoglobin

Hereditary persistence of fetal Hb (HPFH), in which HbF production persists into childhood and beyond, is included in

the thalassemias. It is usually a form of  $\delta\beta$ -thalassemia in which continued  $\gamma$ -chain synthesis compensates for the lack of  $\delta$  and  $\beta$  chains. HbF may account for 20% to 30% of total Hb in heterozygotes and 100% in homozygotes. Individuals are usually symptom free.

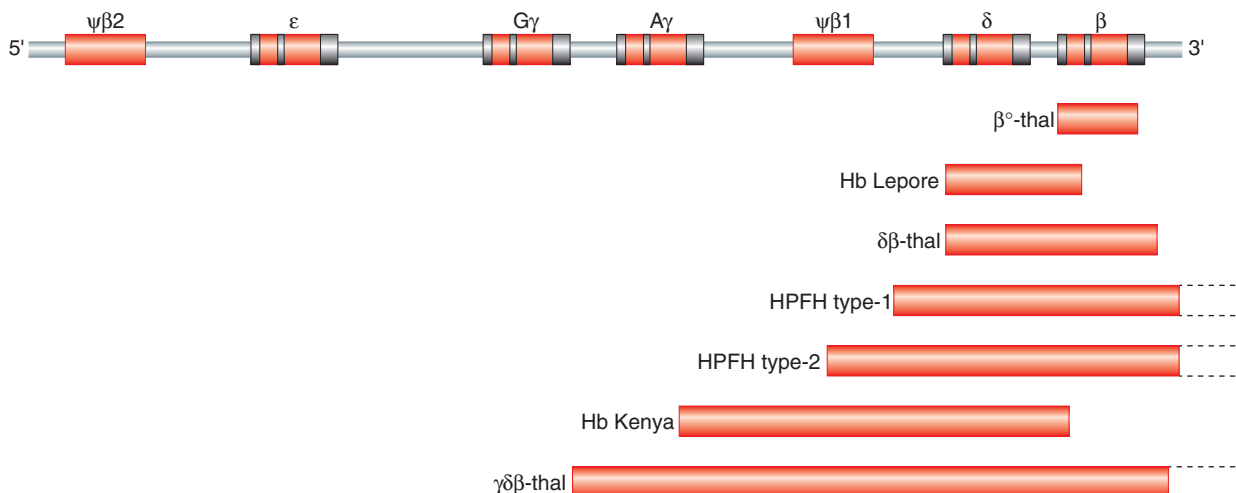
#### Mutational Basis of HPFH

Some forms of HPFH are due to deletions of the  $\delta$ - and  $\beta$ -globin genes, whereas non-deletion forms may have point mutations in the 5' flanking promoter region of either the  $G\gamma$  or  $A\gamma$ -globin genes near the CAAT box sequences (p. 16), which are involved in the control of Hb gene expression.

### Clinical Variation of the Hemoglobinopathies

The marked mutational heterogeneity of  $\beta$ -thalassemia means that affected individuals are often compound heterozygotes (p. 71), i.e., they have different mutations in their  $\beta$ -globin genes, leading to a broad spectrum of severity, including intermediate forms—**thalassemia intermedia**—which require less frequent transfusions.

Certain areas of the world show a high prevalence of all the hemoglobinopathies and, not unexpectedly, individuals may have two different disorders of Hb. In the past, precise diagnoses were difficult but DNA sequencing has greatly helped to solve conundrums—e.g., individuals heterozygous for both HbS and  $\beta$ -thalassemia (i.e., compound heterozygotes). Certain combinations can result in a previously unexplained mild form of what might otherwise be anticipated to be a severe hemoglobinopathy. For example, deletion of one or two of the  $\alpha$ -globin genes in a person homozygous for  $\beta$ -thalassemia results in a milder illness because there is less of an imbalance in globin chain production. Similarly, the presence of one form of HPFH in a person homozygous for  $\beta$ -thalassemia or sickle cell can contribute to amelioration of the disease as the increased production of  $\gamma$ -globin chains compensates for the deficient  $\beta$ -globin chain production. The relative severity of different homozygous or compound heterozygous hemoglobinopathies is helpfully summarized in a risk assessment tool produced by the NHS Sickle Cell and Thalassemia Screening Programme (Figure 12.13).



**FIGURE 12.12** Some of the deletions in the  $\beta$ -globin region that result in some forms of thalassemia and hereditary persistence of fetal hemoglobin.

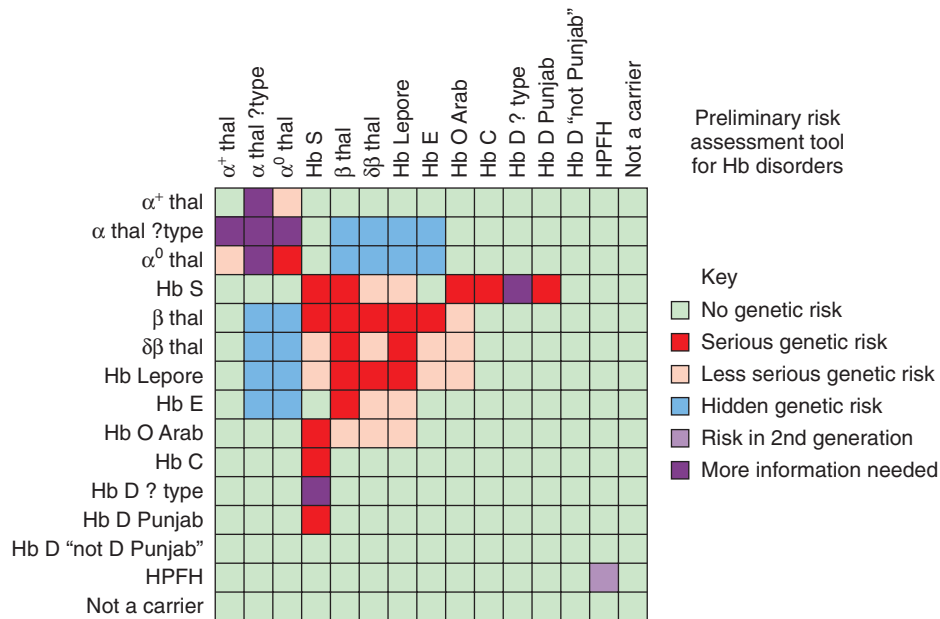


FIGURE 12.13 A hemoglobinopathy tool depicting the anticipated clinical severity associated with the occurrence of different homozygous or compound heterozygous states.

### Antenatal and Newborn Hemoglobinopathy Screening

SC and thalassemia screening was introduced in newborns in the United Kingdom in 2005, and in most areas antenatal screening is under way. The purpose is the presymptomatic diagnosis of infants with serious hemoglobinopathies so that early treatment can be instituted and long-term complications minimized. The genetic risk to future pregnancies is also identified. The programs also mean that parental testing, cascade screening through the wider family, and genetic counseling, can be offered when a carrier infant is identified.

The decision to perform antenatal screening is in some regions guided by the findings of an ethnicity and family history questionnaire administered to the pregnant woman. Initial screening is undertaken on a simple full blood count, looking for anemia (Hb < 11 g/dl) and microcytosis MCH (mean corpuscular hemoglobin/0 < 27 pg). These findings prompt electrophoresis by high performance liquid chromatography, summarized in Figure 12.14. As with all screening, this program aims to reduce the burden of health care in the long term and improve quality of life.

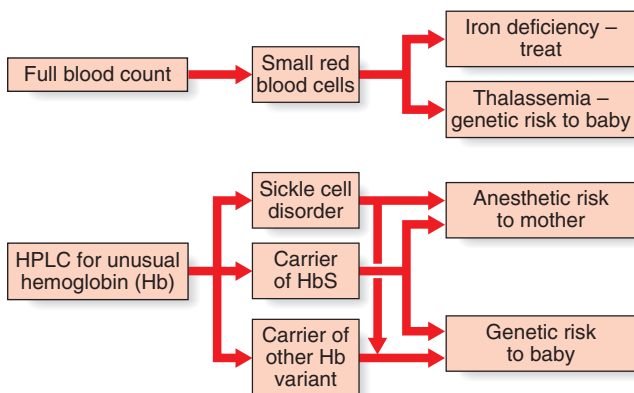


FIGURE 12.14 Antenatal screening for hemoglobinopathies.

### FURTHER READING

Cooley, T.B., Lee, P., 1925. A series of cases of splenomegaly in children with anemia and peculiar bone changes. *Trans. Am. Pediatr. Soc.* 37, 29–40.  
*The original description of  $\beta$ -thalassemia.*  
 Giardine, B., Borg, J., Viennas, E., et al., 2014. Updates of the HbVar database of human hemoglobin variants and thalassemia mutations. *Nucleic Acids Res.* 42 (Database issue), D1063–D1069.  
*A helpful introduction to the HbVar database.*  
 Pauling, L., Itano, H.A., Singer, S.J., Wells, I.C., 1949. Sickle-cell anaemia, a molecular disease. *Science* 110, 543–548.  
*The first genetic disease in which a molecular basis was described, leading to a Nobel Prize.*  
 Serjeant, G.R., Serjeant, B.E., 2001. *Sickle Cell Disease*, third ed. Oxford University Press, Oxford.  
*Excellent, comprehensive text covering all aspects of this important disorder.*  
 Weatherall, D.J., Clegg, J.B., 2008. *The Thalassemia Syndromes*, fourth ed. [onlinelibrary.wiley.com/book/10.1002/9780470696705](http://onlinelibrary.wiley.com/book/10.1002/9780470696705)  
 Copyright 2001 Blackwell Science Ltd.  
*An authoritative and comprehensive text, available online.*

### Websites

<http://www.nhr.nhs.uk/>.  
*The National Haemoglobinopathy Registry (NHR) is a database of patients with red cell disorders (mainly sickle cell disease and thalassaemia major) living in the UK. Various useful reports are available online.*  
<https://www.gov.uk/guidance/sickle-cell-and-thalassaemia-screening-programme-overview>.  
*An overview of the NHS sickle cell and thalassaemia screening programme.*

**ELEMENTS**

- 1** Hemoglobin (Hb), the protein present in red blood cells responsible for oxygen transport, is a tetramer made up of two dissimilar pairs of polypeptide chains and the iron-containing molecule, heme.
- 2** Human Hb is heterogeneous. During development, it comprises a succession of different globin chains that are expressed differentially during embryonic, fetal, and adult life (e.g.,  $\alpha_2\varepsilon_2$ ,  $\alpha_2\gamma_2$ ,  $\alpha_2\delta_2$ ,  $\alpha_2\beta_2$ ).
- 3** The disorders of Hb—the hemoglobinopathies—can be divided into two main groups: the structural disorders of Hb, such as sickle-cell Hb (HbS), and disorders of production, or synthesis—the thalassemias. The former can be subdivided by the way in which they interfere with the normal *function* of Hb and/or the red blood cell (e.g., abnormal oxygen affinity, hemolytic anemia). The latter can be subdivided according to which globin chain is produced abnormally (i.e.,  $\alpha$ -,  $\beta$ -, or  $\delta\beta$ -thalassemia).
- 4** Screening for hemoglobinopathies has been introduced in many countries, not only in those areas with a high prevalence. Without such measures the burden of disease would be much higher; early detection facilitates early treatment and reduced morbidity from long term consequences, and in many places prenatal diagnosis for the serious disorders is accepted.

# Immunogenetics

*Medicinal discovery,  
It moves in mighty leaps,  
It leapt straight past the common cold  
And gave it us for keeps.*

PAM AYERS

## Immunity

The immune system defends us against armies of microorganisms that, numerically, dwarf the human population. Without it we would not survive and in order to understand the inherited disorders of immunity we must look at the fundamentals of the genetic basis of immunity.

Immune defense mechanisms can be divided into two main types: **innate immunity**, which includes a number of non-specific systems that do not require or involve prior contact with the infectious agent, and **specific acquired or adaptive immunity**, which involves a tailor-made immune response that occurs after exposure to an infectious agent. Both types can involve either **humoral immunity**, which combats extracellular infections, or **cell-mediated immunity**, which fights intracellular infections.

## Innate Immunity

The first simple defense against infection is the mechanical barrier of the skin, which functions most of the time as an impermeable barrier but in addition, the acidic pH of sweat is inhibitory to bacterial growth. Mucus membranes line the respiratory and gastrointestinal tracts, and the respiratory tract is further protected by ciliary movement. Other body fluids contain a variety of bactericidal agents, such as lysozymes in tears. If an organism succeeds in invading the body, a healthy immune system reacts immediately by recognizing the alien intruder and a chain of response is triggered.

## Cell-Mediated Innate Immunity

### Phagocytosis

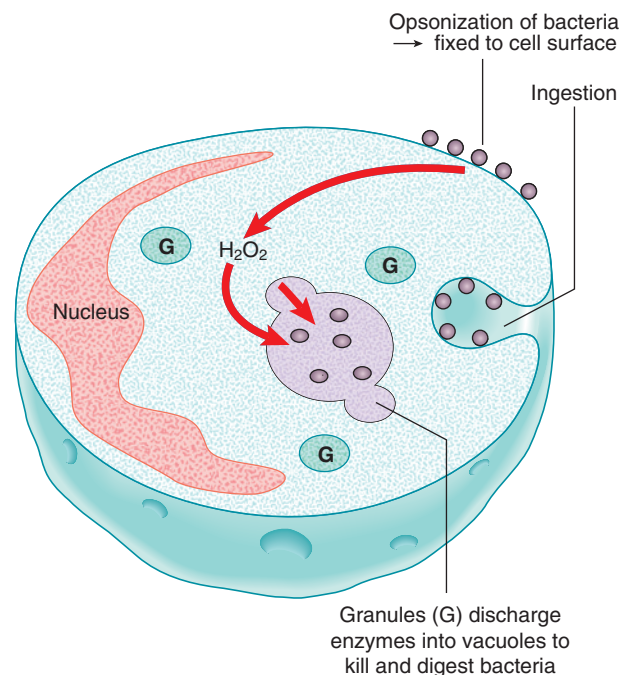
Two major cell types go on the offensive when a foreign microorganism invades—macrophages and neutrophils. Macrophages are the mature form of circulating monocytes that migrate into tissues and occur primarily around the basement membrane of blood vessels in connective tissue, lung, liver, and the lining of the sinusoids of the spleen and the medullary sinuses of the lymph nodes. They are believed to play a key role in the orchestration of both the innate and adaptive responses, and can recognize invading microorganisms through surface receptors able to distinguishing between self and pathogen. Recognition of the foreign material leads to phagocytosis by the macrophage, followed rapidly by neutrophils recruited from the circulation during the inflammatory process. The activation

of the macrophage triggers the inflammatory process through the release of inflammatory mediators. The invading organism is destroyed by fusion with intracellular granules of the phagocyte and exposure to the action of hydrogen peroxide, hydroxyl radicals, and nitrous oxide (Figure 13.1).

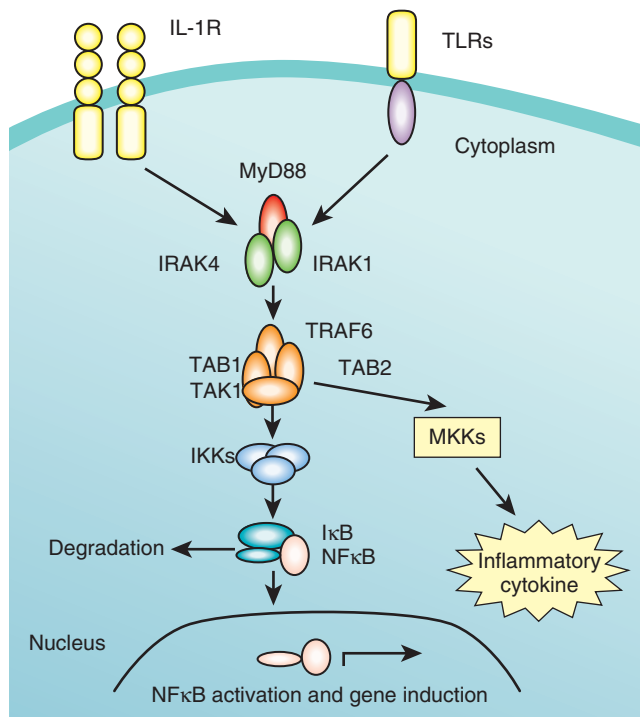
## The Toll-Like Receptor Pathway

A key component of cell-mediated immunity is the **Toll-like receptor (TLR)** pathway. TLRs are conserved transmembrane receptors, which in fruit fly embryos play a critical role in dorsal-ventral development. However, their mammalian homologs function in innate immune responses and microbial recognition (in adult *Drosophila melanogaster*, the pathway is responsible for the formation of antimicrobial peptides) and belong to the interleukin-1/TLR superfamily. The superfamily has two subgroups based on the extracellular characteristics of the receptor—i.e., whether they possess an immunoglobulin-like domain or leucine-rich repeats. TLRs typically have extracellular leucine-rich repeats.

There are 10 TLRs in man, each receptor being responsible for recognition of a specific set of pathogen-associated molecular patterns. TLR2 has been well characterized and has an essential role in the detection of invading pathogens, recognizing peptidoglycans and lipoproteins associated with gram-positive bacteria, as well as a host of other microbial and endogenous ligands. The primary function of TLR2 is therefore lipoprotein-mediated



**FIGURE 13.1** Phagocytosis and the pathways involved in intracellular killing of microorganisms.



**FIGURE 13.2** The Toll-like receptor (TLR) and interleukin-1 receptor (IL-1R) pathways, which share many of the same proteins. Activation of TLR2 and other TLRs, via NF $\kappa$ B activation and gene induction, leads to dendritic cell maturation, upregulation of expression of the major histocompatibility complex and co-stimulatory molecules, and production of immuno-stimulatory cytokines. *IKK*, I kappa kinase; *I $\kappa$ B*, NF $\kappa$ B inhibitor; *IRAK*, IL-1R-associated protein kinases; *MKK*, MAP kinases; *MyD88*, adapter molecule; *TAB1*, TAK1-binding protein 1; *TAB2*, TAK1-binding protein 2; *TAK1*, transforming growth factor- $\beta$ -activated kinase; *TRAF6*, tumor necrosis factor receptor-associated factor 6.

signaling, and activation of the pathway by recognition of its ligand results in activation of the transcription factor NF- $\kappa$ B, which in turn results in the increased expression of co-stimulatory molecules and inflammatory cytokines (Figure 13.2). These cytokines help mediate migration of dendritic cells from infected tissue to lymph nodes, where they may encounter and activate leukocytes involved in the adaptive immune response. The signaling pathways used by TLRs share many of the same proteins as the interleukin-1 receptor (IL-1R) pathway (Figure 13.2). Activation of TLR leads to recruitment of the MyD88 (this is sometimes known as the MyD88-dependent pathway) which mediates the interaction between IL-1R associated kinases 1 and 4 (IRAK1 and IRAK4).

The activation of the Toll pathway has several important effects in inducing innate immunity. These effects include the production of cytokines and chemokines, including IL-1, IL-6, and tumor necrosis factor-alpha (TNF- $\alpha$ ), which have local effects in containing infection and systemic effects with the generation of fever and induction of acute phase responses, including production of C-reactive protein. One important medical condition related to the Toll pathway is **septic shock**, as activation of the Toll pathway by certain ligands induces systemic release of TNF- $\alpha$ . There are also important health-related consequences that result from *TLR2* deficiency or mutation. *TLR2* deficient mice are susceptible to infection by Gram-positive bacteria as well as meningitis from *Streptococcus pneumoniae*.

## Extracellular Killing

Virally infected cells can be killed by large granular lymphocytes, known as **natural killer (NK) cells**. These have carbohydrate-binding receptors on their cell surface that recognize high molecular weight glycoproteins expressed on the surface of the infected cell as a result of the virus taking over the cellular replicative functions. NK cells play an early role in viral infections and are activated by cytokines from macrophages. They recognize virally infected cells through changes either in glycoproteins or in the expression of major histocompatibility complex (MHC) class I on virally infected host cells. Binding to the infected cells results in the release of a number of agents, which in turn results in damage to the membrane of the infected cell, leading to cell death.

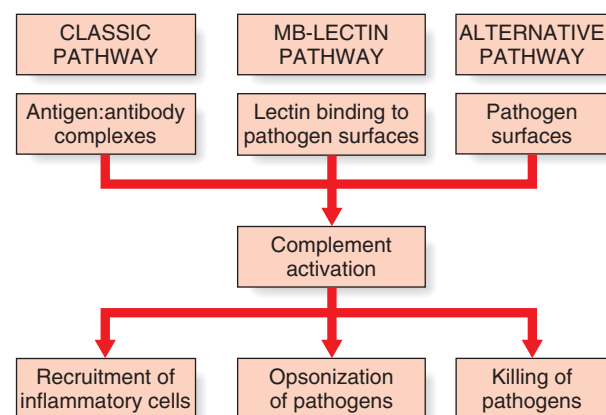
## Humoral Innate Immunity

Several soluble factors are involved in innate immunity; they help to minimize tissue injury by limiting the spread of infectious microorganisms. These are called the **acute-phase proteins** and include C-reactive protein, mannose-binding protein, and serum amyloid P component. The first two act by facilitating the attachment of one of the components of complement, C3b, to the surface of the microorganism, which becomes opsonized (made ready) for adherence to phagocytes, whereas the latter binds lysosomal enzymes to connective tissues. In addition, cells infected by virus synthesize and secrete interferon- $\alpha$  and interferon- $\beta$ , which have a role in promoting the cellular response to viral infection by NK cell activation and upregulation of the MHC class I. In addition, **interferon** interferes with viral replication by reducing messenger RNA (mRNA) stability and interfering with translation.

## Complement

The complement system is a complex of 20 or so plasma proteins that cooperate to attack extracellular pathogens. Although the critical role of the system is to opsonize pathogens, it also recruits inflammatory cells and kills pathogens directly through membrane attack complexes. The complement system can be activated through three pathways: the classical pathway, the alternative pathway, and the mannose-binding lectin (MBL) pathway (see Figure 13.3).

Complement nomenclature, like much else in immunology, can be confusing. Each component is designated by the letter



**FIGURE 13.3** The classic and alternative pathways of complement activation. The main functions of complement are recruitment of inflammatory cells, opsonization of pathogens, and killing of pathogens. *MB*, mannose-binding.

C, followed by a number. But they were numbered in order of their discovery rather than the sequence of reactions. The reaction sequence is C1, C4, C3, C5, C6, C7, C8, and C9. The product of each cleavage reaction is designated by letters, the larger fragment being 'b' (b = big), and the smaller fragment 'a'. In the lectin pathway, MBL in the blood binds another protein, a serine protease called MBL-associated serine protease (MASP). When MBL binds to its target (for example, mannose on the surface of a bacterium), the MASP protein functions like a convertase to clip C3 into C3a and C3b. C3 is abundant in the blood, so this happens very efficiently. The other two complement pathways also converge toward C3 convertase, which cleaves C3. C3a mediates inflammation while C3b binds to the pathogen surface, coating it and acting as an opsonin. The effector roles of the major complement proteins can be summarized according to function as follows (Figure 13.4):

1. Opsonisation: C3b and C4b are opsonins that coat foreign organisms, greatly enhancing their phagocytosis—phagocytes have receptors that recognize complement proteins bound to a pathogen.
2. Inflammation: C5a, as well as C4a and C3a, are inflammatory activators that induce vascular permeability, and recruit and activate phagocytes.
3. Lysis: C5b binds and recruits C6 and C7, eventually forming the **membrane attack complex (MAC)**, C5b678, which catalyzes the polymerization of the final component C9, forming a transmembrane pore of approximately 10 nm diameter, and cell lysis.

4. Immune complex clearance: Complement has a critical role in removing immune complexes from the circulation. The immune complex binds C4b and C3b, which then binds to receptors on red blood cells and the complexes are transported to the liver and spleen, where the complexes are given up to phagocytes for destruction.

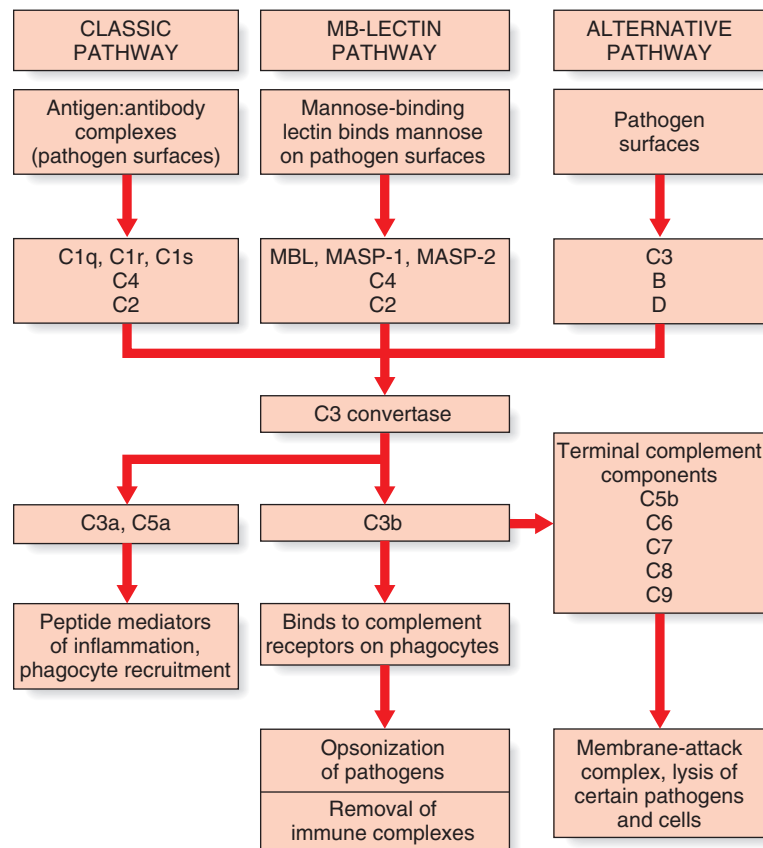
There are clinical consequences relating to mutations in the genes of these pathways. The frequency of mutations of the *MBL2* gene in the general population may be 5% to 10%. Although most individuals with MBL deficiency from mutations and promoter polymorphisms in *MBL2* are healthy, there is an increased risk, severity, and frequency of infections and autoimmunity, as reported in infants with recurrent respiratory tract infection, otitis media, and chronic diarrhea.

### Specific Acquired Immunity

Many infective microorganisms have, through mutation and selective pressures, developed strategies to overcome or evade the mechanisms associated with innate immunity. There is a need, therefore, to be able to generate specific acquired or adaptive immunity. This can, as with innate immunity, be separated into both humoral and cell-mediated processes.

### Humoral Specific Acquired Immunity

The main mediators of humoral specific acquired immunity are immunoglobulins, or antibodies. Antibodies are able to recognize and bind to surface antigens of infecting microorganisms,



**FIGURE 13.4** Overview of the main components and effector actions of complement. Note that the MBL pathway involves the MBL protein, MASP-1, MASP-2, C4, and C2. MASP acts as a C3 convertase, creating a C3b fragment from C3. C3b attaches to the pathogen surface and binds to receptors on phagocytes, leading to opsonization. C3b can also combine with other proteins on the pathogen surface and form a membrane attack complex.



leading to the activation of phagocytes and the initiation of the **classic pathway** of complement, resulting in the generation of the MAC (see [Figure 13.4](#)) and other complement effector functions. Exposure to a specific antigen results in the clonal proliferation of a small ('B') lymphocyte derived from the bone marrow, resulting in mature antibody-producing cells, or **plasma cells**.

Lymphocytes that produce antibodies express copies of the immunoglobulin (Ig) for which they code on their surface, which acts as a surface receptor for antigen. Binding of the antigen, in conjunction with other MASPs, results in signal transduction leading to the clonal expansion and production of antibody. The **primary response** is the production of IgM, followed by IgG. Re-exposure to the same antigen results in a swifter response and enhanced antibody levels, which is the **secondary response**, amounting to the antigen-specific **immunological memory**.

### Immunoglobulins

The immunoglobulins, or antibodies, are one of the major classes of serum protein. Their function, both in the recognition of antigenic variability and in effector activities, was first revealed by study of their structure, and later by DNA analysis.

#### Immunoglobulin Structure

Papain, a proteolytic enzyme, splits the immunoglobulin molecule into three fragments. Two of the fragments are similar, each containing an antibody site capable of combining with a specific antigen and therefore referred to as the **antigen-binding fragment** or **Fab**. The third fragment can be crystallized and was called **Fc**, and this component determines the secondary biological functions of antibodies, binding complement and Fc receptors on different cell types involved in the immune response.

The immunoglobulin molecule is made up of four polypeptide chains—two 'light' (L) and two 'heavy' (H)—of approximately 220 and 440 amino acids in length, respectively. They are held together in a Y-shape by disulfide bonds and non-covalent interactions. Each Fab fragment is composed of L chains linked to the amino-terminal portion of the H chains, whereas each Fc fragment is composed only of the carboxy-terminal portion of the H chains ([Figure 13.5](#)).

#### Immunoglobulin Isotypes, Subclasses, and Idiotypes

There are five different types of heavy chain, designated respectively as  $\gamma$ ,  $\mu$ ,  $\alpha$ ,  $\delta$ , and  $\epsilon$ , one each for the five major antibody classes—the **isotypes**—IgG, IgM, IgA, IgD, and IgE,

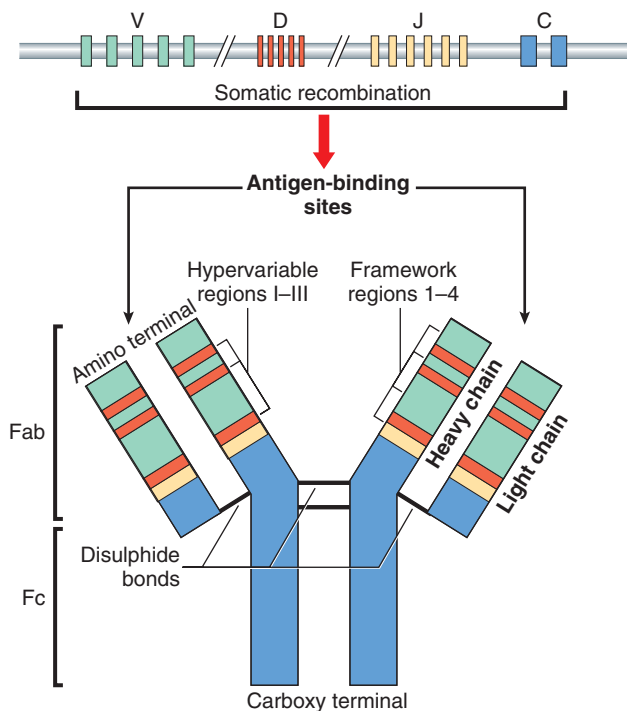


FIGURE 13.5 Model of antibody molecule structure.

respectively. The L chains are of two types—kappa ( $\kappa$ ) or lambda ( $\lambda$ ), and these occur in all five classes of antibody, but only one type occurs in each individual antibody. Thus, the molecular formula for IgG is  $\lambda_2\gamma_2$  or  $\kappa_2\gamma_2$ . The characteristics of the various classes of antibody are outlined in [Table 13.1](#). In addition, there are four IgG subclasses—IgG1, IgG2, IgG3, and IgG4—and two IgA subclasses—IgA1 and IgA2—that differ in their amino acid sequence and interchain disulfide bonds. Individual antibody molecules that recognize specific antigens are known as **idiotypes**.

#### Immunoglobulin Allotypes

The five immunoglobulin classes occur in all normal individuals, but allelic variants, or what are known as antibody **allotypes** of these classes, have also been identified. These are the *Gm* system associated with the heavy chain of IgG, the *Am* system associated with the IgA heavy chain, the *Km* and *Inv* systems associated with the  $\kappa$  light chain, the *Oz* system for the  $\lambda$  light chain and the *Em* allotype for the IgE heavy chain. The *Gm* and *Km* systems are independent of each other and are polymorphic ([p. 88](#)), the frequencies of the different alleles varying in different ethnic groups.

Table 13.1 Classes of Human Immunoglobulin (Ig)

Class	Mol. wt (Da)	Serum Concentration (mg/mL)	Antibody Activity	Complement Fixation	Placental Transfer
IgG	150,000	8–16	Binds to microorganisms and neutralizes bacterial toxins	+	+
IgM	900,000	0.5–2	Produced in early immune response, especially in bacteremia	+	–
IgA	160,000	1.4–4	Guards mucosal surfaces	+	–
IgD	185,000	0–0.4	On lymphocyte cell surface, involved in control of activation and suppression	–	–
IgE	200,000	Trace	In parasitic and allergic reactions	–	–

## Generation of Antibody Diversity

It could seem paradoxical for a single protein molecule to exhibit sufficient structural heterogeneity to have specificity for a large number of different antigens. Different combinations of H and L chains could, to some extent, account for this diversity. It would, however, require thousands of structural genes for each chain type to provide sufficient variability for the large number of antibodies produced in response to the equally large number of antigens to which individuals can be exposed. Our initial understanding of how this works came from persons with a malignancy of antibody-producing cells—**multiple myeloma**.

### Multiple Myeloma

People with multiple myeloma make a single or monoclonal antibody species in large abundance, which in a proportion of patients is detected in their urine. This is known as **Bence Jones protein** and consists of antibody L chains. The amino-terminal ends of this protein molecule in different patients are quite variable in sequence, whereas the carboxy-terminal ends are relatively constant. These are called the **variable (V)** and **constant (C)** regions, respectively. However, the V regions of different myeloma proteins show four regions that vary little from one antibody to another, known as **framework regions (FR 1–4)**, and three markedly variable regions interspersed between these, known as **hypervariable regions (HV I–III)** (see Figure 13.5).

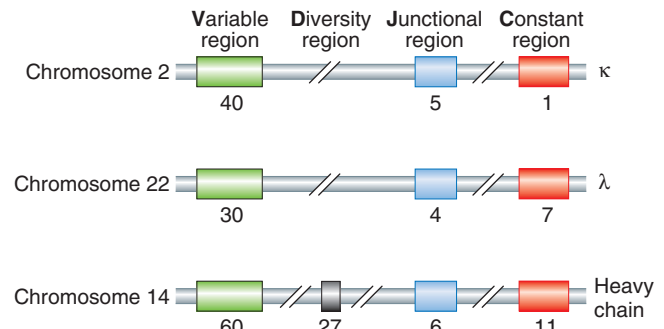
### DNA Studies of Antibody Diversity

In 1965 Dreyer and Bennett proposed that an antibody could be encoded by separate 'genes' in germline cells that undergo rearrangement or, as they termed it, 'scrambling', in lymphocyte development. Comparison of the restriction maps of the DNA segments coding for the C and V regions of the immunoglobulin  $\lambda$  light chains in embryonic and antibody-producing cells revealed that they were far apart in the former but close together in the latter. Detailed analysis revealed that the DNA segments coding for the V and C regions of the light chain are separated by some 1500 base-pairs (bp) in antibody-producing cells. The intervening DNA segment was found to code for a **joining (J)** region immediately adjacent to the V region of the light chain. The  $\kappa$  L-chain was shown to have the same structure. Cloning and DNA sequencing of H-chain genes in germline cells revealed that they have a fourth region, called **diversity (D)**, between the V and J regions.

There are estimated to be some 60 different DNA segments coding for the V region of the H-chain, 40 for the V region of the  $\kappa$  L-chain, and 30 for the  $\lambda$  L-chain V region. Six functional DNA segments code for the J region of the H-chain, five for the J region of the  $\kappa$  L-chain, and four for the J region of the  $\lambda$  L-chain. A single DNA segment codes for the C region of the  $\kappa$  L-chain, seven for the C region of the  $\lambda$  L-chain and 11 functional DNA segments code for the C region of the different classes of H-chain. There are also 27 functional DNA segments coding for the D region of the H-chain (Figure 13.6). The genomic regions in question also contain a large number of unexpressed DNA sequences or pseudogenes (p. 12).

### Antibody Gene Rearrangement

The genes for the  $\kappa$  and  $\lambda$  L-chains and the H-chains are located on chromosomes 2, 22, and 14, respectively. Only one of each of the relevant types of DNA segment is expressed in any single

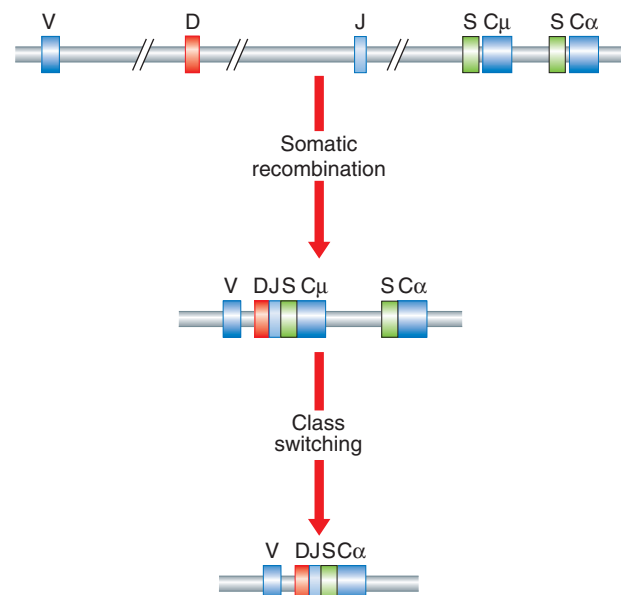


**FIGURE 13.6** Estimated number of the various DNA segments coding for the  $\kappa$ ,  $\lambda$ , and various heavy chains.

antibody molecule. The DNA coding segments for the various portions of the antibody chains on these chromosomes are separated by DNA that is non-coding. Somatic recombinational events involved in antibody production involve short conserved recombination signal sequences that flank each germline DNA segment (Figure 13.7). Further diversity occurs by variable mRNA splicing at the V–J junction in RNA processing and by somatic mutation of the antibody genes. These mechanisms readily account for the antibody diversity seen in nature, though how particular DNA segments are selected to produce an antibody to a specific antigen is not fully resolved.

### Class Switching of Antibodies

There is a normal switch of antibody class produced by B cells on continued, or further, exposure to antigen—from IgM, the initial class of antibody produced in response to exposure to an antigen, to IgA or IgG. This **class switching** retains specificity of the antibody to the same antigen. Analysis of class switching in a population of cells derived from a single B cell has shown that both classes of antibody have the same antigen-binding sites, having the same V region but differing only in their C region. Class switching occurs by a somatic recombination event that involves DNA segments, designated S (for switching), that lead to looping out and deletion of the intervening



**FIGURE 13.7** Immunoglobulin heavy-chain gene rearrangement and class switching.

DNA. The result is to eliminate the DNA segment coding for the C region of the H-chain of the IgM molecule, and to bring the gene segment encoding the C region of the new class of H-chain adjacent to the segment encoding the V region (see Figure 13.7).

### The Immunoglobulin Gene Superfamily

Several other molecules involved in the immune response have been shown to have structural and DNA sequence homology to the immunoglobulins. This involves a 110-amino acid sequence characterized by a centrally placed disulfide bridge that stabilizes a series of antiparallel  $\beta$  strands into an 'antibody fold'. This group of structurally similar molecules has been called the **immunoglobulin superfamily** (p. 12). It consists of eight multigene families that, in addition to the  $\kappa$  and  $\lambda$  L-chains and different classes of H-chain, include the chains of the T-cell receptor (p. 12), the class I and II MHC, or human leukocyte antigens (HLA) (p. 170). Other molecules in this group include the T-cell CD4 and CD8 cell surface receptors, which cooperate with T-cell receptors in antigen recognition, and the intercellular adhesion molecules-1, -2, and -3, which are involved in leukocyte-endothelial adhesion and extravasation, T-cell activation, and T-cell homing.

### Antibody Engineering

At the beginning of the 20th century, Paul Ehrlich proposed the idea of the 'magic bullet'—the hope that one day there might be a compound that would selectively target a disease-causing organism. Today we have monoclonal antibodies (mAb) and, for almost any substance, it is possible to create a specific antibody that binds that substance. Monoclonal antibodies are the same because they are made by one type of immune cell which are all clones of a unique parent cell.

In the 1970s it was found that the B-cell cancer, multiple myeloma, produced a single type of antibody—a **paraprotein**. This facilitated the study of the structure of antibodies but it was not possible to produce identical antibodies specific to a given antigen. Myeloma cells cannot grow because they lack hypoxanthine-guanine-phosphoribosyl transferase, which is necessary for DNA replication. Typically, mAb are made by fusing myeloma cells with spleen cells from a mouse (or rabbit) that has been immunized with the desired antigen. They are then grown in medium which is selective for these hybrids—the spleen cell partner supplies hypoxanthine-guanine-phosphoribosyl transferase and the myeloma has immortal properties because it is a cancer cell. The cell mixture is diluted and clones grown from single parent cells. The antibodies secreted by different clones are assayed for their ability to bind the antigen, and the healthiest clone selected for future use. The hybrids can also be injected into the peritoneal cavity of mice to produce tumors containing antibody-rich ascitic fluid, and the mAb then has to be extracted and purified.

To overcome the problem of purification, recombinant DNA technologies have been used since the 1980s. DNA that encodes the binding portion of mouse mAb is merged with human antibody-producing DNA. Mammalian cell culture is then used to express this DNA, producing chimeric antibodies. The goal, of course, is to create 'fully human' mAb, which has met with success in 'phage display-generated' antibodies and mice that have been genetically modified to produce more human-like antibodies.

Specific mAb have now been developed and approved for the treatment of cancer, cardiovascular disease, inflammatory

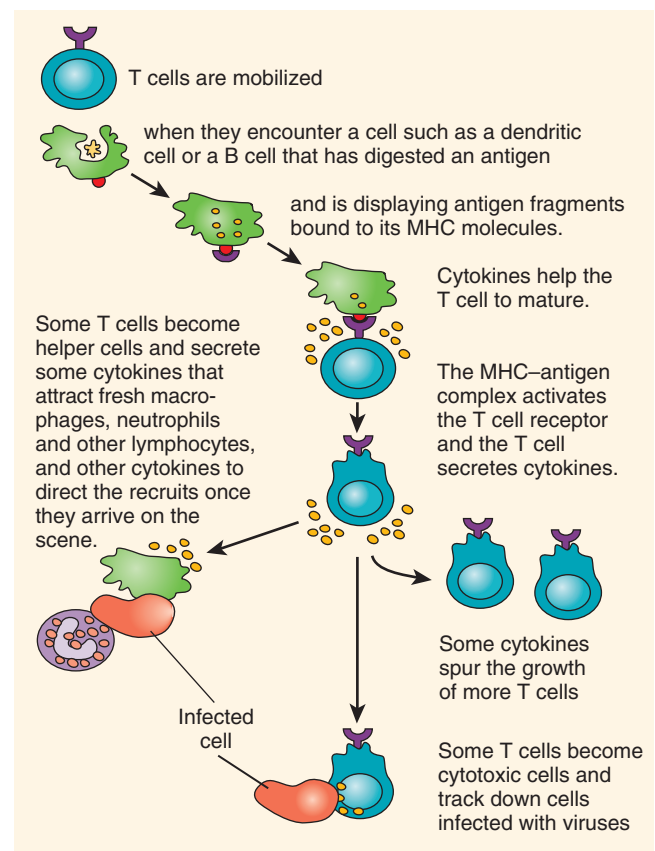
diseases, macular degeneration, and transplant rejection, among others. A mAb that inhibits TNF- $\alpha$  has applications in rheumatoid arthritis, Crohn disease, and ulcerative colitis; one that inhibits IL-2 on activated T cells is used in preventing rejection of transplanted kidneys, and another inhibits vascular endothelial growth factor with a role in antiangiogenic cancer therapy.

### Cell-Mediated Specific Acquired Immunity

Certain microorganisms, viruses, and parasites live inside host cells. As a result, a separate form of specific acquired immunity has developed to combat intracellular infections involving lymphocytes differentiated and matured in the thymus—hence **T cells**. T lymphocytes have specialized receptors on the cell surface, known as **T-cell surface antigen receptors**, which in conjunction with the MHC on the cell surface of the infected cell result in the involvement of different subsets of T cells, each with a distinct function—**T helper cells** and **cytotoxic T cells**. The battle against intracellular infections is a cooperative, coordinated response from these separate components of the immune system, leading to death of the infected cell (Figure 13.8).

### T-Cell Surface Antigen Receptor

T cells express on their surface an antigen receptor, which distinguishes them from other lymphocyte types, such as B cells and NK cells. The antigen consists of two different polypeptide chains, linked by a disulfide bridge, that both contain two immunoglobulin-like domains, one that is relatively invariant in structure, the other highly variable like the Fab portion



**FIGURE 13.8** T cells and the cooperative response resulting in death of an infected cell. *MHC*, Major histocompatibility complex.

of an immunoglobulin. The diversity in T-cell receptors required for recognition of the range of antigenic variation that can occur is generated by a process similar to that seen with immunoglobulins. Rearrangement of variable (V), diversity (D), junctional (J), and constant (C) DNA segments during T-cell maturation, through a similar recombination mechanism as occurs in B cells, results in a contiguous VDJ sequence. Binding of antigen to the T-cell receptor, in conjunction with an associated complex of transmembrane peptides, results in signaling the cell to differentiate and divide.

### The Major Histocompatibility Complex

The MHC plays a central role in the immune system. Its role is to bind antigen peptides processed intracellularly and present this material on the cell surface, with co-stimulatory molecules, where it can be recognized by T cells. MHC molecules occur in three classes: class I occur on virtually all cells and are responsible for presenting cytotoxic T cells; class II occur on B cells and macrophages and are involved in signaling T-helper cells to present further B cells and macrophages; and the non-classic class III molecules include a number of other proteins with a variety of other immunological functions. The latter include inflammatory mediators such as the TNF, heat-shock proteins, and the various components of complement.

Structural analysis of class I and II MHC molecules reveal them to be heterodimers with homology to immunoglobulin. The genes coding for the class I (A, B, C, E, F, and G), class II (DR, DQ, and DP) and class III MHC molecules, or what is also known as the **human leukocyte antigen (HLA)** system, are located on chromosome 6.

### Transplantation Genetics

Organ transplantation has become routine in clinical medicine and, with the exception of corneal and bone grafts, success depends on the degree of antigenic similarity between donor and recipient. The closer the similarity, the greater the likelihood that the transplanted organ or tissue (the **homograft**), will be accepted rather than rejected. Homograft rejection does not occur between identical twins or between non-identical twins where there has been mixing of the placental circulations before birth (p. 40). In all other instances, the antigenic similarity of donor and recipient has to be assessed by testing them with suitable antisera or monoclonal antibodies for antigens on donor and recipient tissues. These were originally known as transplantation antigens but are now known to be a result of the MHC. As a general rule, a recipient will reject a graft from any person who has antigens that the recipient lacks. HLA typing of an individual is carried out using PCR-based techniques (p. 50).

The HLA system is highly polymorphic (Table 13.2). A virtually infinite number of phenotypes resulting from different combinations of the various alleles at these loci are theoretically possible. Two unrelated individuals are therefore very unlikely

**Table 13.2** Alleles at the HLA Loci

HLA Locus	Number of Alleles
A	57
B	111
C	34
D	228

HLA, Human leukocyte antigen.

**Table 13.3** Some HLA-Associated Diseases

Disease	HLA
Ankylosing spondylitis	B27
Celiac disease	DR4
21-Hydroxylase deficiency	A3/Bw47/DR7
Hemochromatosis	A3
Insulin-dependent diabetes (type 1)	DR3/4
Myasthenia gravis	B8
Narcolepsy	DR2
Rheumatoid arthritis	DR4
Systemic lupus erythematosus	DR2/DR3
Thyrotoxicosis (Graves' disease)	DR3

HLA, Human leukocyte antigen.

to have identical HLA phenotypes. The close linkage of the HLA loci means that they tend to be inherited *en bloc*, the term **haplotype** being used to indicate the particular HLA alleles that an individual carries on each of the two copies of chromosome 6. Thus, any individual will have a 25% chance of having identical HLA antigens with a sibling, as there are only four possible combinations of the two paternal (say P and Q) and the two maternal (say R and S) haplotypes, i.e., PR, PS, QR, and QS. The siblings of a particular recipient are more likely to be antigenically similar than either of his or her parents, and the latter more than a non-relative. Therefore, a sibling is frequently selected as a potential donor.

Although recombination occurs within the HLA region, certain alleles tend to occur together more frequently than would be expected by chance, i.e. they tend to exhibit linkage disequilibrium (p. 92). An example is the association of the HLA antigens A1 and B8 in populations of western European origin.

### H-Y Antigen (aka Müllerian Inhibiting Factor, MIF)

In a number of different animal species, it was noted that tissue grafts from males were rejected by females of the same inbred strain. These incompatibilities were found to be due to a histocompatibility antigen known as H-Y. However, H-Y seems to play little part in transplantation in humans. The H-Y antigen, aka Müllerian Inhibiting Factor (MIF), which is not the SRY gene, is important for testicular differentiation (see p. 124) and function, but its expression does not correlate with the presence or absence of testicular tissue.

### HLA Polymorphisms and Disease Associations

The association of certain diseases with certain HLA types (Table 13.3) should shed light on the pathogenesis of the disease, but in reality this not well understood. The best documented is between ankylosing spondylitis and HLA-B27. Narcolepsy, a condition of unknown etiology characterized by a periodic uncontrollable tendency to fall asleep, is almost invariably associated with HLA-DR2. The possession of a particular HLA antigen does not mean that an individual will necessarily develop the associated disease, only that the *relative* risk of being affected is greater than the general population. In a family, the risks to first-degree relatives of those affected are low, usually no more than 5%.

Explanations for the various HLA-associated disease susceptibilities include close linkage to a susceptibility gene near the HLA complex, cross-reactivity of antibodies to environmental antigens or pathogens with specific HLA antigens, and abnormal recognition of 'self' antigens through defects in T-cell

receptors or antigen processing. These conditions are known as **autoimmune diseases**. An example of close linkage is congenital adrenal hyperplasia from a 21-hydroxylase deficiency (p. 261) from mutated *CYP21*, which lies within the HLA major histocompatibility locus. This form of congenital adrenal hyperplasia is strongly associated with HLA-A3/Bw47/DR7 in northern European populations. Non-classical 21-hydroxylase deficiency is associated with HLA-B14/DR1, and HLA-A1/B8/DR3 is *negatively* associated with 21-hydroxylase deficiency.

## Inherited Immunodeficiency Disorders

Inherited immunodeficiency disorders are uncommon and sometimes severe but, with early diagnosis and optimum management many patients with primary immune deficiency (PID) can remain very well. Prompt diagnosis is very important in order that treatment, for example antimicrobials, immunoglobulin, or bone marrow transplant, be instituted before significant irreversible end-organ damage takes place. Presentation is variable but often in childhood for more severe immune defects, especially after the benefits of maternal transplacental immunity have declined from 3–4 months of age. New diagnoses of PID are sometimes made in adults. Investigation of immune function should be considered in all patients with recurrent infections and in children with failure to thrive. Failure to thrive, diarrhea, and hepatosplenomegaly may also be features.

## Primary Inherited Disorders of Immunity

The manifestations of at least some of the PID diseases in humans can be understood by considering whether they are disorders of either innate or specific acquired immunity. Abnormalities of *humoral* immunity are associated with reduced resistance to bacterial infections and may be lethal in infancy. Abnormalities of *cell-mediated* specific acquired immunity are associated with increased susceptibility to viral infections and are manifest experimentally in animals by prolonged survival of skin homografts.

## Disorders of Innate Immunity

Primary disorders of innate immunity are considered under humoral and cell-mediated immunity categories.

### Disorders of Innate Humoral Immunity

A variety of defects of complement can lead to disordered innate immunity.

**Disorders of complement.** If a complement defect is suspected, investigation of the integrity of the classic and alternative pathways should begin with functional assays looking at the entire pathway. If functional abnormalities are found, measurement of the individual components of that pathway can be undertaken.

The clinical effects of MBL deficiency have been described previously. Defects of the third component of complement, C3, lead to abnormalities of opsonization of bacteria, resulting in difficulties in combating pyogenic infections. Defects in the later components of complement—those involved in the formation of the MAC (p. 166)—also result in susceptibility to bacterial infection, particularly *Neisseria* (meningococcal infections). This includes deficiency of properdin (factor P), a plasma protein active in the alternative complement pathway.

C1 inhibitor deficiency follows autosomal dominant inheritance and there are two forms—type 1 due to low levels, and

type 2 resulting from non-functioning protein. Inappropriate activation and poor control of the complement pathway occurs with breakdown of C2 and C4, and production of inflammatory mediators. C1 inhibitor also controls the kinin-bradykinin pathway and when deficient an accumulation of bradykinin in the tissues occurs, and is believed to be the main cause of edema, triggered by episodes of surgery, dental work, trauma, and some drugs. Attacks vary in severity from mild cutaneous to abdominal pain and swelling, which can be severe, and laryngeal edema is potentially fatal. This is known as **hereditary angio-edema**. Acute attacks are treated with C1 inhibitor concentrate, a blood product, which has superseded fresh frozen plasma when available. In due course, a recombinant C1 inhibitor may become the treatment of choice. The drug Danazol, an androgen, is the mainstay of long-term prevention.

Other associations with disease include homozygous C2 deficiency. There are various case reports of individuals who developed cutaneous vasculitis, Henoch-Schönlein purpura, seropositive rheumatoid arthritis, polyarteritis, membranoproliferative glomerulonephritis, and an association with systemic lupus erythematosus (SLE). Similarly, C4 is associated with SLE. The copy number of C4 genes in a diploid human genome varies from two to six in the white population. Each of these genes encodes either a C4A or C4B protein. Individuals with only two copies of total C4 are at significantly increased risk of SLE, whereas those with five copies or more are at decreased risk.

## Defects in NFκB Signaling

Inappropriate **activation** of nuclear factor kappa-B (NFκB) has been linked to inflammation associated with autoimmune arthritis, asthma, septic shock, lung fibrosis, glomerulonephritis, atherosclerosis, and AIDS. Conversely, persistent **inhibition** of NFκB has been linked directly to apoptosis, abnormal immune cell development, and delayed cell growth.

Since 2000, mutations have occasionally been found in the X-linked *IKK-gamma* gene, part of the TLR pathway (p. 164), in children demonstrating failure to thrive, recurrent digestive tract infections, often with intractable diarrhea, and recurrent ulcerations, respiratory tract infections with bronchiectasis, and recurrent skin infections. Presentation is in infancy, suggesting susceptibility to various gram-positive and gram-negative bacteria. Sparse scalp hair is sometimes a feature and in older children oligodontia and conical-shaped maxillary lateral incisors have been noted. Survival ranged from 9 months to 17 years in one study. IgG is low and IgM usually high. Interestingly, *IKK-g* is the same as *NEMO*, the gene that causes X-linked dominant incontinentia pigmenti (pp. 73–74). However, in this condition of the immune system mutations occur in exon 10 of the gene.

IRAK4 is another component of the TLR pathway and deficiency leads to recurrent infections, mainly from gram-positive microorganisms, though also fungi. There is a reduced inflammatory response. Infections begin early in life but become less frequent with age, some patients requiring no treatment by late childhood. It follows autosomal recessive inheritance.

### Disorders of Innate Cell-Mediated Immunity

An important mechanism in innate cell-mediated immunity is phagocytosis, as previously discussed, which results in subsequent cell-mediated killing of microorganisms.

**Chronic granulomatous disease (CGD).** This is the best known example of a disorder of phagocytic function, and follows either an X-linked or an autosomal recessive inheritance. It results from an inability of phagocytes to kill ingested microbes, due to defects in the NADPH oxidase enzyme complex which generates the so-called microbicidal 'respiratory burst' (see Figure 13.1). Hypergammaglobulinemia may be present. CGD is therefore associated with recurrent bacterial or fungal infections, and may present as suppurative lymphadenitis, hepatosplenomegaly, pulmonary infiltrates, and/or eczematoid dermatitis. Childhood mortality was high until the advent of supportive treatment and prophylactic antibiotics. Bone marrow transplant has been successful, as well as transplantation of peripheral blood stem cells from an HLA-identical sibling.

**The neutropenias.** The neutropenias are a heterogeneous group of disorders of varying severity, following different patterns of inheritance, and characterized by very low neutrophil counts. Autosomal dominant or sporadic congenital neutropenia (SCN1) is caused by mutation in the neutrophil elastase gene (*ELA2*), whilst mutation in the proto-oncogene *GFI1*, which targets *ELA2*, also causes dominantly inherited neutropenia (SCN2). Mutation in the *HAX1* gene causes autosomal recessive SCN3 ('classical' SCN—Kostmann disease), whereas autosomal recessive SCN4 is caused by mutation in the *G6PC3* gene. SCN patients with **acquired** mutations in the granulocyte colony-stimulating factor receptor (*CSF3R*) gene in hematopoietic cells are at high risk for developing acute myeloid leukemia.

In SCN, hematopoiesis is characterized by a maturation arrest of granulopoiesis at the promyelocyte level; peripheral absolute neutrophil counts are below  $0.5 \times 10^9/L$  and there is early onset of severe bacterial infections. As well as dominantly inherited SCN1, there is an X-linked form caused by a constitutively activating mutation in the *WAS* gene, mutated in Wiskott-Aldrich syndrome.

Cyclic neutropenia is rare, characterized by regular 21-day fluctuations in the numbers of blood neutrophils, monocytes, eosinophils, lymphocytes, platelets, and reticulocytes. This results in patients experiencing periodic symptoms of fever, malaise, mucosal ulcers, and occasionally life-threatening infections. As with SCN1, it is due to mutated *ELA2*.

**Leukocyte adhesion deficiency (LAD).** Individuals with LAD present with life-threatening bacterial infections of the skin and mucous membranes and impaired pus formation. The increased susceptibility to infections occurs because of defective migration of phagocytes from abnormal adhesion-related functions of chemotaxis and phagocytosis. This disorder is fatal unless antibiotics are given, both for infection and prophylactically, until bone marrow transplantation can be offered. Three different forms of LAD are recognized, each with unique clinical features, though leukocytosis is a constant feature. LAD I and LAD II, and usually LAD III, follow autosomal recessive inheritance; LAD II and LAD III are very rare.

LAD I is characterized by delayed separation of the umbilical cord, omphalitis, and severe recurrent infections with no pus formation. It is due to mutated *ITGB2* (21q22) and encodes the  $\beta_2$  subunit of the integrin molecule.

LAD II patients have the rare Bombay blood group and suffer from psychomotor retardation and growth delay; it is also known as congenital disorder of glycosylation type IIc (CDG2C). It is caused by mutations in *SLC35C1* (11p11), the gene encoding the Golgi-specific GDP-fucose transporter.

LAD III is similar to LAD I but includes severe neonatal bleeding tendency. Various defects in leukocyte chemotaxis and adhesion to endothelial cells have been found and the diagnosis is reached by showing defects in the integrin activation process; the CD18 molecule is structurally intact. It is due to mutated *FERMT3* (11p13).

### **Autoimmune Polyendocrinopathy-Candidosis-Ectodermal Dysplasia Syndrome**

Autoimmune polyendocrinopathy syndrome type I is characterized by the presence of two of three major clinical symptoms: Addison disease, hypoparathyroidism, and chronic mucocutaneous candidiasis, and is caused by mutations in the autoimmune regulator (*AIRE*) gene. Malabsorption and diarrhea can be striking and dominate the clinical picture, and immune disorders may be present, though diabetes mellitus and thyroid disease are infrequent. The onset of Addison disease is mostly in childhood or early adulthood, and frequently accompanied by chronic active hepatitis, malabsorption, juvenile-onset pernicious anemia, alopecia, and primary hypogonadism.

### **Disorders of Specific Acquired Immunity**

Again, these can be considered under the categories of disorders of humoral and cell-mediated specific acquired immunity.

#### *Disorders of Humoral Acquired Immunity*

Abnormalities of immunoglobulin function lead to an increased tendency to develop bacterial infections.

**Bruton-type agammaglobulinemia.** Boys with this X-linked immunodeficiency usually develop multiple recurrent bacterial infections of the respiratory tract and skin after the first few months of life, having been protected initially by placentally transferred maternal IgG. Features similar to rheumatoid arthritis develop in many and they are not prone to viral infection. Treatment of life-threatening infections with antibiotics and the use of prophylactic intravenous immunoglobulins have improved survival prospects, but children with this disorder can still die from respiratory failure through complications of repeated lung infections. The diagnosis of this type of immunodeficiency is confirmed by demonstration of immunoglobulin deficiency and absence of B lymphocytes. The disorder has been shown to result from mutations in a tyrosine kinase specific to B cells (Btk) that result in loss of the signal for B cells to differentiate to mature antibody-producing plasma cells. A rarer, autosomal recessive, form of agammaglobulinemia shows marked depression of the circulating lymphocytes, and lymphocytes are absent from the lymphoid tissue.

**Hyper-IgM syndrome (HIGM).** HIGM is another genetically heterogeneous condition that includes increased levels of IgM, and also usually of IgD, with levels of the other immunoglobulins being decreased or virtually absent. Patients are susceptible to recurrent pyogenic infections, as well as opportunistic infections such as *Pneumocystis* and *Cryptosporidium*, because of primary T-cell abnormality. In the X-linked form (HIGM1) the mutated gene encodes a cell surface molecule on activated T cells called CD40 ligand (renamed *TNFSF5*). When the gene is not functioning immunoglobulin class switches are inefficient, so that IgM production cannot be readily switched to IgA or IgG. IgM levels are therefore high, and IgG levels reduced. At least four other types are recognized including autosomal recessive forms, HIGM2 (CD40 deficiency) and HIGM3 (activation-induced cytidine deaminase, *AICDA*) deficiency.

**Hyper-IgE syndrome (HIES).** Again heterogeneous, this condition is sometimes known as Job syndrome and is a PID characterized by chronic eczema, recurrent staphylococcal infections, increased serum IgE, and eosinophilia. Abscesses may be 'cold', i.e. they lack associated warmth, erythema, or tenderness. Patients have a distinctive coarse facial appearance, abnormal dentition, hyperextensibility of the joints, and bone fractures. Autosomal dominant HIES is caused by mutation in the *STAT3* gene and autosomal recessive by mutation in *DOCK8*.

**Common variable immunodeficiency (CVID).** CVID has tended to be a 'wastebasket' category but constitutes the most common group of B-cell deficiencies characterized by normal numbers of immunoglobulin-bearing B-cell precursors and a broad deficiency of immunoglobulin isotypes. It is very heterogeneous with at least 12 genetic varieties identified. The presentation is similar to other forms of immune deficiency, at any age, including nodular lymphoid hyperplasia, and males and females are equally affected. Affecting approximately 1:800 Caucasians, selective IgA deficiency is the most frequently recognized PID. Many affected people have no obvious health problems, but others may have recurrent infections, gastrointestinal disorders, autoimmune diseases, allergies, or malignancies. The pathogenesis is arrest of B-cell differentiation, giving rise to a normal number of IgA-bearing B-cell precursors but a profound deficit in IgA-producing plasma cells. The response to immunization with protein and polysaccharide antigens is abnormal.

#### Disorders of Cell-Mediated Specific Acquired Immunity

The most common inherited disorder of cell-mediated specific acquired immunity is severe combined immunodeficiency (SCID).

**Severe combined immunodeficiency.** SCID, as the name indicates, is associated with an increased susceptibility to both viral and bacterial infections because of profoundly abnormal humoral and cell-mediated immunity. Common to all forms of SCID is the absence of T cell-mediated cellular immunity from defective T-cell development. Presentation is in infancy with recurrent, persistent, opportunistic infections by many organisms, including *Candida albicans*, *Pneumocystis carinii*, and cytomegalovirus. The incidence of all types of SCID is approximately 1:75,000. Death usually occurs in infancy because of overwhelming infection, unless a bone marrow transplant is performed. SCID is genetically heterogeneous and can be inherited as either an X-linked or autosomal recessive disorder. The X-linked form (SCIDX1) is the most common form of SCID in males, accounting for 50% to 60% overall, and has been shown to be due to mutations in the  $\gamma$  chain of the cytokine receptor for IL-2 (*IL2RG*). In approximately one-third to one-half of children with SCID that is not X-linked, inheritance is autosomal recessive (SCID1) and the different forms are classified according to whether they are B-cell negative (T-B-) or B-cell positive (T-B+). The presence or absence of NK cells is variable.

T-B+ SCID, apart from SCIDX1, includes deficiencies of the protein tyrosine phosphatase receptor type C (or CD45) deficiency. CD45 suppresses Janus kinases (JAK), and there is a specific B-cell-positive SCID due to JAK3 deficiency, which can be very variable—from subclinical to life threatening in early childhood. Other rare autosomal recessive forms of SCID include mutation in the *IL7R* gene—*IL2RG* is dependent on a functional interleukin-7 receptor.

T-B- SCID includes **adenosine deaminase deficiency**, which accounts for approximately 15% of all SCID and one-third of autosomal recessive SCID. The phenotypic spectrum is variable, the most severe being SCID presenting in infancy and usually resulting in early death. Ten to 15% of patients have a 'delayed' clinical onset by age 6 to 24 months, and a smaller percentage of patients have 'later' onset, diagnosed from 4 years to adulthood, showing less severe infections and gradual immunologic deterioration. The immune system is affected through the accumulation of purine degradation products that are selectively toxic to T cells. Rare forms of B-cell negative SCID include mutated *RAG1/RAG2* (recombination activating genes), which are normally responsible for VDJ recombinations (p. 170) that lead to mature immunoglobulin chains and T-cell receptors. In addition, cases occur due to mutation in the *Artemis* gene (DNA cross-link repair protein 1c—*DCLRE1C*). The latter forms are both sensitive to ionizing radiation. Lastly, reticular dysgenesis is a rare and very severe form of SCID characterized by congenital agranulocytosis, lymphopenia, and lymphoid and thymic hypoplasia with absent cellular and humoral immunity functions. It is due to mutation in the mitochondrial *Adenylate kinase-2* gene (*AK2*).

#### Secondary or Associated Immunodeficiency

There are a number of hereditary disorders in which immunological abnormalities occur as one of a number of associated features as part of a syndrome.

#### DiGeorge/Sedláčková Syndrome (Deletion 22q11.2)

Children with the **DiGeorge/del22q11.2 syndrome** (see p. 245), well described by Sedláčková in 1955, 10 years earlier than DiGeorge, present with recurrent viral illnesses and are found to have abnormal cellular immunity as characterized by reduced numbers of T lymphocytes, as well as abnormal antibody production. This is due to partial absence of the thymus gland, leading to defects in cell-mediated immunity and T cell-dependent antibody production. Usually these defects are relatively mild and improve with age, as the immune system matures, but occasionally the immune deficiency is very severe because no T cells are produced and bone marrow transplantation is indicated. It is important for all patients diagnosed to be investigated by taking a full blood count with differential CD3, CD4, and CD8 counts, and immunoglobulins. The levels of diphtheria and tetanus antibodies can indicate the ability of the immune system to respond. These patients usually have a characteristic face (see Figure 17.17, p. 246), frequently congenital heart disease, and hypoplastic parathyroid glands. The latter can result in presentation in the newborn period with hypocalcemic tetany secondary to low parathyroid hormone levels.

#### Ataxia Telangiectasia

**Ataxia telangiectasia** is an autosomal recessive disorder in which children present in early childhood with signs of cerebellar ataxia, dilated blood vessels on the sclera of the eyes, ears, and face (oculocutaneous telangiectasia), and a susceptibility to sinus and pulmonary infections. Low serum IgA levels occur, and a hypoplastic thymus, as a result of a defect in the cellular response to DNA damage. The diagnosis is made by the demonstration of low or absent serum IgA and IgG as well as characteristic chromosome abnormalities on culture of peripheral blood lymphocytes—a form of chromosome instability

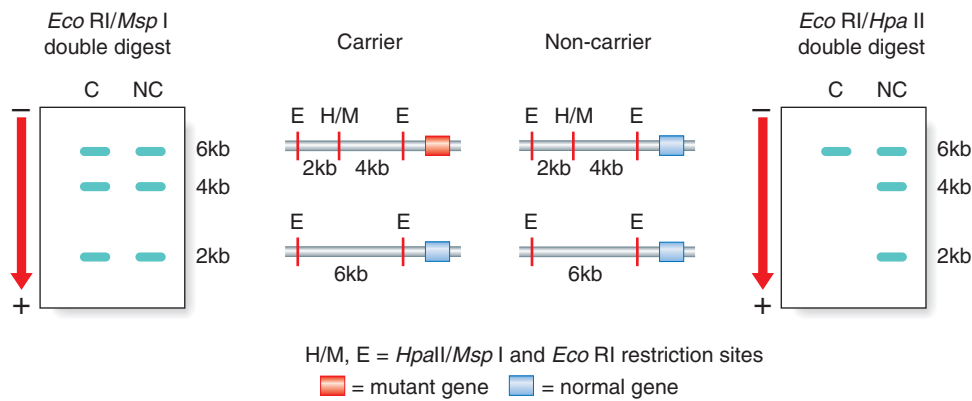


FIGURE 13.9 Non-random inactivation in T lymphocytes for carrier testing in X-linked SCID.

(p. 253), and/or DNA testing. Patients have an increased risk of developing leukemia or lymphoid malignancies.

### Wiskott-Aldrich Syndrome (WAS)

This X-linked recessive disorder affects boys who present with eczema, diarrhea, recurrent infections, thrombocytopenia, and, usually, low serum IgM levels and impaired T-cell function and numbers. Mutations in the *WAS* gene (Xp11) result in loss of cytotoxic T-cell responses and T-cell help for B-cell response, leading to an impaired response to bacterial infections. Until the advent of bone marrow transplantation, the majority of affected boys died by mid-adolescence from hemorrhage or B-cell malignancy.

### Carrier Tests for X-Linked Immunodeficiencies

Before it was possible to sequence the genes responsible for Wiskott-Aldrich syndrome, Bruton-type hypogammaglobulinemia, and X-linked SCID, the availability of closely linked DNA markers allowed female carrier testing by studies of the pattern of X-inactivation (p. 121) in the lymphocytes of females at risk. A female relative of a sporadically affected male with an X-linked immunodeficiency would be confirmed as a carrier by the demonstration of a non-random pattern of X-inactivation—'skewed' X-inactivation (p. 122)—in the T-lymphocyte population, indicating that all her peripheral blood T lymphocytes had the same chromosome inactivated (Figure 13.9).

The carrier (C) and non-carrier (NC) are both heterozygous for an *HpaII/MspI* restriction site polymorphism. *HpaII* and *MspI* recognize the same nucleotide recognition sequence, but *MspI* cuts double-stranded DNA whether it is methylated or not, whereas *HpaII* cuts only unmethylated DNA (i.e., only the active X chromosome). In the carrier female, the SCID gene mutation is on the X chromosome on which the

*HpaII/MspI* restriction site is present. *EcoRI/MspI* double digests of T lymphocytes result in 6, 4, and 2-kilobase (kb) DNA fragments on gel analysis of the restriction fragments for both the carrier and non-carrier females. *EcoRI/HpaII* double digests of T-lymphocyte DNA result, however, in a single 6-kb fragment in the carrier female. This is because in a carrier the only T cells to survive will be those in which the normal gene is on the active unmethylated X chromosome. Thus, whilst X-inactivation appears to be non-random, it is actually cell population survival that is non-random.

### Blood Groups

Blood groups reflect the antigenic determinants on red cells and were one of the first areas in which an understanding of basic biology led to significant advances in clinical medicine. Our knowledge of the ABO and Rhesus blood groups has resulted in safe blood transfusion and the prevention of Rhesus hemolytic disease of the newborn.

### The ABO Blood Groups

The ABO blood groups were discovered by Landsteiner early in the twentieth century. In some cases blood transfusion resulted in rapid hemolysis because of incompatibility. Four major ABO blood groups were discovered: A, B, AB, and O. Those with blood group A possess the antigen A on the surface of their red blood cells, blood group B has antigen B, AB has both antigens, and those with blood group O have neither. People of blood group A have naturally occurring anti-B antibodies, and blood group B have anti-A, whereas blood group O have both. The alleles at the ABO blood group locus are inherited in a co-dominant manner but are both dominant to the gene for the O antigen. There are, therefore, six possible genotypes (Table 13.4).

Table 13.4 ABO Blood Group Phenotypes and Genotypes

Red Blood Cells		React With Antiserum		
Phenotype	Genotype	Antibodies	Anti-A	Anti-B
O	OO	Anti-A,B	–	–
A	AA, AO	Anti-B	+	–
B	BB, BO	Anti-A	–	+
AB	AB	–	+	+



Blood group AB individuals do not produce A or B antibodies, so they can receive a blood transfusion from people of all other ABO blood groups, and are therefore referred to as **universal recipients**. On the other hand, because individuals of group O do not express either A or B antigens on their red cells, they are referred to as **universal donors**. Antisera can differentiate two subgroups of blood group A, A1, and A2, but this is of little practical importance as far as blood transfusions are concerned.

Individuals with blood groups A, B, and AB possess enzymes with glycosyltransferase activity that convert the basic blood group, known as the 'H' antigen, into the oligosaccharide antigens 'A' or 'B'. The alleles for blood groups A and B differ in seven single base substitutions that result in different A and B transferase activities, the A allele being associated with the addition of *N*-acetylgalactosaminyl groups and the B allele with the addition of D-galactosyl groups. The O allele results from a critical single base-pair deletion that results in an inactive protein incapable of modifying the H antigen.

### Rhesus Blood Group

The Rhesus (Rh) blood group system involves three sets of closely linked antigens, Cc, Dd, and Ee. D is very strongly antigenic and persons are, for practical purposes, either Rh positive (possessing the D antigen) or Rh negative (lacking the D antigen).

### Rhesus Hemolytic Disease of the Newborn

A proportion of women who are Rh-negative have an increased chance of having a child who will either die in utero or be born severely anemic because of hemolysis, unless transfused in utero. This occurs because if Rh-positive blood is given to persons who are Rh-negative, the majority will develop anti-Rh antibodies. Such sensitization occurs with exposure to very small quantities of blood and, once a person is sensitized, further exposure results in the production of very high antibody titers.

In the case of an Rh-negative mother carrying an Rh-positive fetus, fetal red cells that cross to the mother's circulation can induce the formation of maternal Rh antibodies. In a subsequent pregnancy, these antibodies can cross the placenta from the mother to the fetus, leading to hemolysis and severe anemia. In its most severe form, this is known as **erythroblastosis fetalis**, or **hemolytic disease of the newborn**. After a woman has been sensitized there is a significantly greater risk that a child in a subsequent pregnancy, if Rh-positive, will be more severely affected.

To avoid sensitizing an Rh-negative woman, Rh-compatible blood must always be used in any blood transfusion. Furthermore, the development of sensitization, and therefore Rh incompatibility after delivery, can be prevented by giving the mother an injection of Rh antibodies—**anti-D**—so that fetal

cells in the maternal circulation are destroyed before the mother can become sensitized.

It is routine to screen all Rh-negative women during pregnancy for the development of Rh antibodies. Despite these measures, a small proportion of women do become sensitized. If Rh antibodies appear, tests are carried out to see whether the fetus is affected. If so, there is a delicate balance between the choice of early delivery, with the risks of prematurity and exchange transfusion, and treating the fetus in utero with blood transfusions.

### Molecular Basis of the Rh Blood Group

There are two types of Rh red cell membrane polypeptide. One corresponds to the D antigen and the other to the C and E series of antigens. Two genes code for the Rh system: one for *D* and *d*, and a second for both *C* and *c* and *E* and *e*. The *D* locus is present in most persons and codes for the major D antigen present in those who are Rh-positive. Rh-negative individuals are homozygous for a deletion of the *D* gene. Therefore, an antibody has never been raised to 'd'.

Analysis of complementary DNA from reticulocytes in Rh-negative persons who were homozygous for *dCe*, *dCE*, and *dce*, allowed identification of the genomic DNA sequences responsible for the different antigenic variants at the second locus, revealing that they are produced by alternative splicing of the mRNA transcript. The *Ee* polypeptide is a full-length product of the *CcEe* gene, very similar in sequence to the *D* polypeptide. The *E* and *e* antigens differ by a point mutation in exon 5. The *Cc* polypeptides are, in contrast, products of a shorter transcript of the same gene through splicing. The difference between *C* and *c* is four amino-acid substitutions in exons 1 and 2.

### Other Blood Groups

There are approximately a further 12 'common' blood group systems of clinical importance in humans, including Duffy, Lewis, MN, and S. These are usually of concern only when cross-matching blood for persons who, because of repeated transfusions, have developed antibodies to one of these other blood group antigens. Until the advent of DNA fingerprinting (p. 52), they were used in linkage studies (pp. 89–90) and paternity testing (p. 321).

### FURTHER READING

- Chapel, H., Haeney, M., Misbah, S., Snowden, N., 2014. *Essentials of Clinical Immunology*, sixth ed. Wiley-Blackwell.  
*Excellent basic immunology textbook.*
- Delves, P.J., Martin, S.J., Burton, D.R., Roitt, I.M., 2011. *Roitt's Essential Immunology*, twelfth ed. Wiley-Blackwell.  
*Excellent basic immunology textbook.*
- Murphy, K., Weaver, C., 2016. *Janeway's immunobiology*, ninth ed. Garland Science, Oxford.  
*Good, well-illustrated, textbook of the biology of immunology.*

## ELEMENTS

- 1 The immune response can be divided into two main types, innate and specific acquired, or adaptive, immunity. Both can be further subdivided into humoral and cell-mediated immunity.
- 2 Innate humoral immunity involves acute-phase proteins that act to minimize tissue injury by limiting the spread of infective organisms that, through the alternative pathway of complement activation, results in a localized inflammatory response and the attraction of phagocytes and opsonization of microorganisms. Complement, which consists of a series of inactive blood proteins that are activated sequentially in a cascade, can also be activated through the classic pathway by antibody binding to antigen.
- 3 Innate cell-mediated immunity involves phagocytosis of microorganisms by macrophages and their intracellular destruction.
- 4 Specific acquired humoral immunity involves production of antibodies by mature B cells or plasma cells in response to an antigen. Antibodies are Y-shaped molecules composed of two identical heavy (H) chains and two identical light (L) chains. The antibody molecule has two parts that differ in their function: two identical antigen-binding sites (Fab) and a single binding site for complement (Fc). There are five classes of antibody, immunoglobulin (Ig)A, IgD, IgE, IgG, and IgM, each with a specific heavy chain. The L chain of any class of antibody can be made up of either kappa ( $\kappa$ ) or lambda ( $\lambda$ ) chains.
- 5 Each Ig L or H chain has a variable (V) region of approximately 110 amino acids at the amino-terminal end. The carboxy-terminal end consists of a constant (C) region of approximately 110 amino acids in the  $\kappa$  and  $\lambda$  L chains and 3–4 times that length in the H chain. Most of the amino-acid sequence variation in both the L and H chains occurs within several small hypervariable regions, which are thought to be the sites of antigen binding. The Ig chains are produced from combinations of separate groups of DNA segments. These consist of one from a variable number of DNA segments coding for the constant (C), variable (V), and joining (J) regions between the V and C regions for the  $\kappa$  and  $\lambda$  L chains and the various types of H chains. The H chains also contain a diversity (D) region located between the V and J regions. The total number of possible antibodies that could be produced by various combinations of these DNA segments accounts for the antibody diversity seen in humans.
- 6 Cell-mediated specific acquired immunity primarily involves T cells that, through the T-cell surface antigen receptor, in conjunction with the major histocompatibility complex (MHC) molecules on the surface of infected cells, engage T helper cells and cytotoxic T cells to combat intracellular infections.
- 7 The MHC or human leukocyte antigen (HLA) system consists of a series of closely linked loci on chromosome 6. The many different alleles that can occur at each locus mean that a very large number of different combinations can result. The HLA loci are inherited *en bloc* as a haplotype. The closer the match of HLA antigens between the donor and recipient in organ transplantation, the greater the likelihood of long-term survival of the homograft. Possession of certain HLA antigens is associated with an increased relative risk of developing specific diseases.
- 8 An understanding of the ABO and Rhesus blood groups has resulted in safe blood transfusions and the prevention of Rhesus hemolytic disease of the newborn.

# The Genetics of Cancer...and Cancer Genetics

Cell biology and molecular genetics have revolutionized our understanding of cancer, especially in recent years as next generation sequencing has been applied to analyzing the genetic architecture of tumors. Concurrently, novel approaches to the treatment of cancer, through targeted drug therapies and immunotherapy, are providing great hope for dramatic improvements in the morbidity and mortality from the disease in its numerous different forms. This is an exciting and rapidly moving field.

All cancer is a genetic disease of **somatic** cells because of aberrant cell division or loss of normal programmed cell death, and the processes from the start of life as a fertilized egg through to advanced cancer are summarized schematically in [Figure 14.1](#). However, a small proportion is strongly predisposed by inherited **germline** mutations behaving as Mendelian traits, but this does not contradict our traditional understanding that, for many cancers, environmental factors are etiologically important, whereas heredity plays a lesser role. This certainly applies to the ‘industrial cancers’, which result from prolonged exposure to carcinogenic chemicals, e.g. cancer of the skin in tar workers, of the bladder in aniline dye workers, angiosarcoma of the liver in process workers making polyvinyl chloride, and of the lung (mesothelioma) in asbestos workers. Even so, for those who have suffered cancer as a consequence of such exposures, it is possible, if not likely, that a proportion may have a genetic predisposition to the action of the carcinogen. The link between cigarette smoking and lung cancer (among others) has been recognized for half a century, but not all smokers develop a tobacco-related malignancy. Studies have shown that smokers with short chromosome telomeres ([p. 25](#)) appear to be at substantially greater risk for tobacco-related cancers than people with short telomeres who have never smoked, or smokers who have long telomeres. Lung cancer can also cluster in families and a range of germline mutations, polymorphisms, and susceptibility loci have been identified as risk factors.

The recognition that a number of rare cancer-predisposing syndromes, as well as a small but significant proportion of common cancers having a hereditary basis, has led to an explosion in our understanding of the genetic basis and cellular biology of cancer in humans. As a general principle, it is now clear that cancers arise as the end result of an accumulation of both inherited and somatic mutations, occurring throughout life, in **proto-oncogenes** and **tumor suppressor** genes. A third class of genes—the DNA **mismatch repair** genes—are also important because their inactivation is thought to contribute to the genesis of mutations in other genes directly affecting DNA repair, cell-cycle control, and cell-death pathways. Germline mutations in at least 100 genes and somatic

*All cancer is genetic, but some cancers are more genetic than others.*

PARAPHRASED FROM *ANIMAL FARM*, BY GEORGE ORWELL

mutations in hundreds of others are known to contribute to the total burden of human cancer. The relationship between cancer risk and the presence of mutations with variable penetrance can be expressed graphically ([Figure 14.2](#)).

## Differentiation Between Genetic and Environmental Factors in Cancer

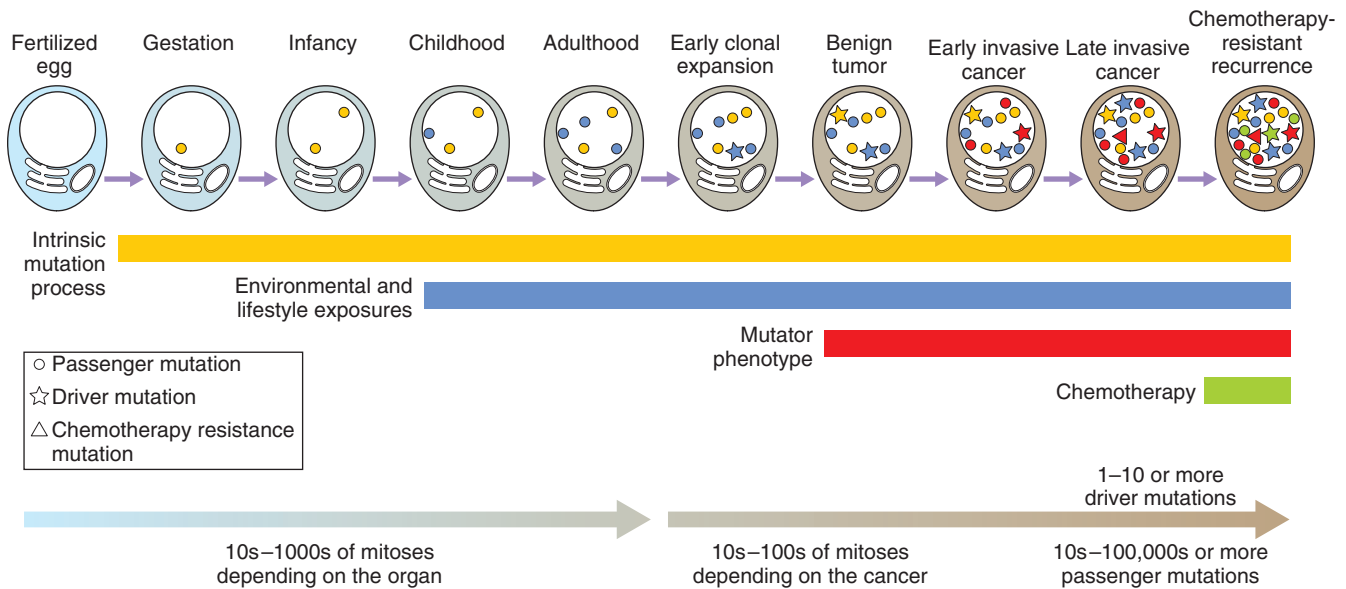
For many cancers, distinguishing between genetic and environmental causative factors is not obvious. There is usually neither a clear-cut mode of inheritance nor a clearly identified environmental cause. Historically, evidence to help distinguish environmental and genetic factors came from a combination of epidemiology, family and twin studies, disease associations, and viral factors, all of which are considered briefly here. Increasingly, in the modern era, molecular analysis and/or DNA tumor profiling provide further evidence, and these are considered later.

### Epidemiology

Breast cancer is the most common cancer in women, with reproductive and menstrual histories being well-recognized risk factors. Parous women, especially multiparous, are at lower risk of developing breast cancer than nulliparous women. Furthermore, the younger the age at first pregnancy and the later the age at menarche, the lower the risk of breast cancer.

The incidence of breast cancer varies greatly between different populations, being highest in women in North America and Western Europe, and up to eight times lower in women of Japanese and Chinese origin. Although these differences could be attributed to genetic differences between these population groups, study of immigrant populations moving from an area with a low incidence to one with a high incidence has shown that the risk of developing breast cancer rises with time to that of the native population, supporting the view that non-genetic factors are highly significant. Some of this changing risk may be accounted for by **epigenetic** factors.

It has long been recognized that people from lower socioeconomic groups have an increased risk of developing gastric cancer. Specific dietary irritants, such as salts and preservatives, or potential environmental agents, such as nitrates, have been suggested as possible carcinogens. Gastric cancer also shows



**FIGURE 14.1** The lineage of mitotic cell divisions from the fertilized egg to a single cell within a cancer showing the timing of the somatic mutations acquired by the cancer cell and the processes that contribute to them. Mutations may be acquired through both intrinsic cell division processes and as a result of mutagens. DNA repair defects may contribute, but driver mutations will cause clonal expansion, with passenger mutations having little overall effect. Relapse following chemotherapy may be due to resistant mutations predated treatment. (Reproduced with permission from Stratton MR, Campbell PJ, Futreal PA 2009 *The cancer genome*. *Nature* 458:719–24.)

variations in incidence in different populations, being up to eight times more common in Japanese and Chinese populations than in those of western European origin. Migration studies have shown that the risk of gastric cancer for immigrants from high-risk populations does not fall to that of the native low-risk population until two to three generations later. It has been suggested that this could be due to exposure to environmental

factors at an early critical age, e.g. early infection with *Helicobacter pylori*, causing chronic gastric inflammation and associated with a fivefold to sixfold increased gastric cancer risk.

### Family and Twin Studies

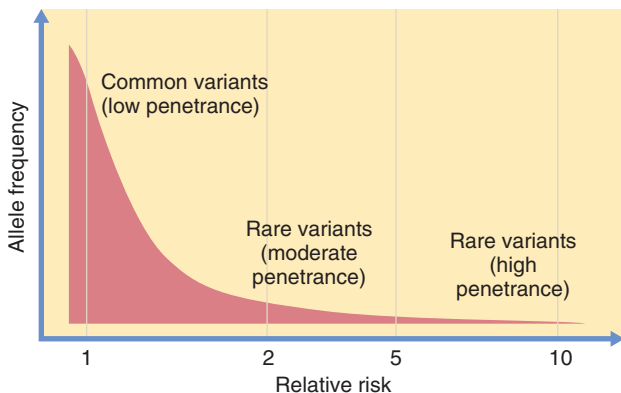
The clustering of cancer cases within families can provide significant evidence supporting a genetic contribution. The lifetime risk of developing breast cancer for a woman who lives until 80 in Western Europe is now approximately 1 in 8. For a woman who has a first-degree relative with breast cancer, the risk that she will also develop breast cancer is between 1.5 and 3 times the risk for the general population. The risk varies according to the age of onset in the affected family member—the earlier the age at diagnosis, the greater the risk to close relatives (p. 192).

Concordance rates for breast cancer in both monozygotic (MZ) and dizygotic (DZ) twins are low, being only slightly greater in MZ female twins, at 17% compared with 13% in DZ female twins. This suggests, overall, that environmental factors are more important than genetic factors. Twin studies in gastric cancer have not shown an increased concordance rate in either MZ or DZ twins.

### Disease Associations

Blood groups are genetically determined, and therefore the association of a particular blood group with a disease suggests a possible genetic contribution to the etiology. A large number of studies have shown an association between blood group A and gastric cancer. It is estimated that those with blood group A have a 20% increased risk of developing gastric cancer. Blood group A is associated with an increased risk of developing pernicious anemia, which is also closely associated with chronic gastritis. However, pernicious anemia appears to have a separate association with gastric cancer, as affected individuals have a threefold to sixfold increased risk.

Genetic architecture of cancer risk



**FIGURE 14.2** Genetic architecture of cancer risk. In the majority of cancer there is a low risk to relatives because genetic associations tend to be with common, low-penetrance alleles identified in genome-wide association studies. The risk to relatives increases markedly when the cancer is associated with rare, high-penetrant genetic variants, such as mutations in the *BRCA1/BRCA2* genes, e.g. hereditary breast and ovarian cancer and the mismatch repair genes associated with Lynch syndrome. (Reproduced with permission from National Cancer Institute: *PDQ Cancer Genetics Overview*. Bethesda, MD: National Cancer Institute. Date last modified January 15, 2016. Available at: <http://www.cancer.gov/about-cancer/causes-prevention/genetics/overview-pdq>. Accessed January 15, 2016.)

**Table 14.1** Human DNA Viruses Implicated in Carcinogenesis

Virus Family	Type	Tumor
Papova	Papilloma (HPV)	Warts (plantar and genital), urogenital cancers (cervical, vulval, and penile), skin cancer
Herpes	Epstein-Barr (EBV)	Burkitt lymphoma*, nasopharyngeal carcinoma, lymphomas in immunocompromised hosts
Hepadna	Hepatitis B (HBV)	Hepatocellular carcinoma†

\*For full oncogenicity, 'co-carcinogens' are necessary

†E.g., aflatoxin B<sub>1</sub> in hepatitis B-associated hepatocellular carcinoma

## Viral Factors

The first indication that transmissible factors can cause cancer came from animal studies performed by Peyton Rous early in the 20th century, among others. In due course these agents were shown to be viruses. Subsequently it was shown that certain viruses are tumor-forming or **oncogenic** in humans. A limited number of DNA viruses are associated with certain types of human tumors (Table 14.1), whereas a variety of RNA viruses, or **retroviruses**, cause neoplasia in animals.

The genetic information of retroviruses is encoded in RNA and they replicate through DNA by coding for an enzyme known as reverse transcriptase (p. 12), which makes a double-stranded DNA copy of the viral RNA. This DNA intermediate integrates into the host cell genome, facilitating appropriate protein manufacture, which results in the repackaging of new progeny virions.

Naturally occurring retroviruses have only three genes necessary to ensure replication (Figure 14.3). Study of the virus responsible for a transmissible tumor in chickens, the so-called Rous sarcoma virus, identified a fourth gene that *transforms* host cells both in vitro and in vivo, causing malignancy. This viral gene is known as an **oncogene**.

## Oncogenes

Oncogenes are the altered forms of normal genes—**proto-oncogenes**—that have key roles in cell growth and differentiation pathways. Normal mammalian cells contain sequences of DNA that are homologous to viral oncogenes, called **proto-oncogenes** or **cellular oncogenes**. Although the terms proto-oncogene and cellular oncogene are often used interchangeably, strictly speaking proto-oncogene is reserved for the normal gene, and cellular oncogene, or *c-onc*, refers to a mutated proto-oncogene, which has oncogenic properties such as the viral oncogenes, or *v-onc*. Approximately 100 oncogenes have been identified.

### Relationship Between *c-onc* and *v-onc*

Cellular oncogenes are highly conserved in evolution, suggesting that they have important roles as regulators of cell growth, maintaining the ordered progression through the cell cycle, cell division, and differentiation. Retroviral oncogenes are thought to acquire their dominant transforming activity during viral transduction through errors in the replication of the retrovirus genome following their random integration into the host DNA. The end result is a viral gene that is structurally similar to its cellular counterpart but is persistently different in its function.

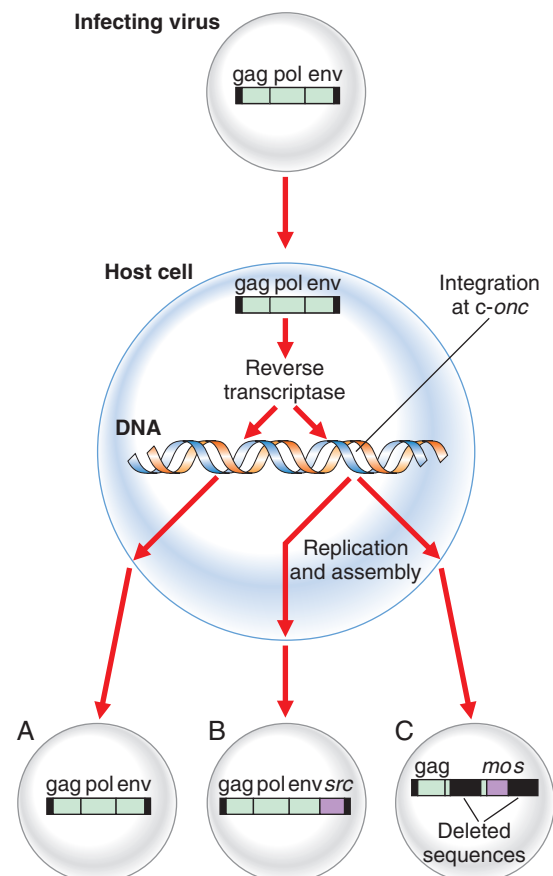
### Identification of Oncogenes

Oncogenes have been identified by two types of cytogenetic finding in association with certain types of leukemia and tumor in humans. These include the location of oncogenes at

chromosomal translocation breakpoints, or their amplification in double-minute chromosomes or homogeneously staining regions of chromosomes (p. 180). In addition, a number of oncogenes have also been identified by the ability of tumor DNA to induce tumors in vitro by DNA transfection.

### Identification of Oncogenes at Chromosomal Translocation Breakpoints

Chromosome aberrations are common in malignant cells, which often show marked variation in chromosome number and structure. Certain chromosomes seemed to be more commonly involved and it was initially thought that these changes were secondary to the transformed state rather than causal. This understanding changed when evidence suggested that chromosomal structural changes, often translocations (p. 35), resulted



**FIGURE 14.3** Model for acquisition of transforming ability in retroviruses. **A**, Normal retroviral replication. **B**, The Rous sarcoma virus has integrated near a cellular oncogene. The transforming ability of this virus is due to the acquired homolog of the cellular oncogene, *v-src*. **C**, A defective transforming virus carries an oncogene similar to *src* but is defective in the structural genes (e.g., Moloney murine sarcoma virus, which carries *mos*).

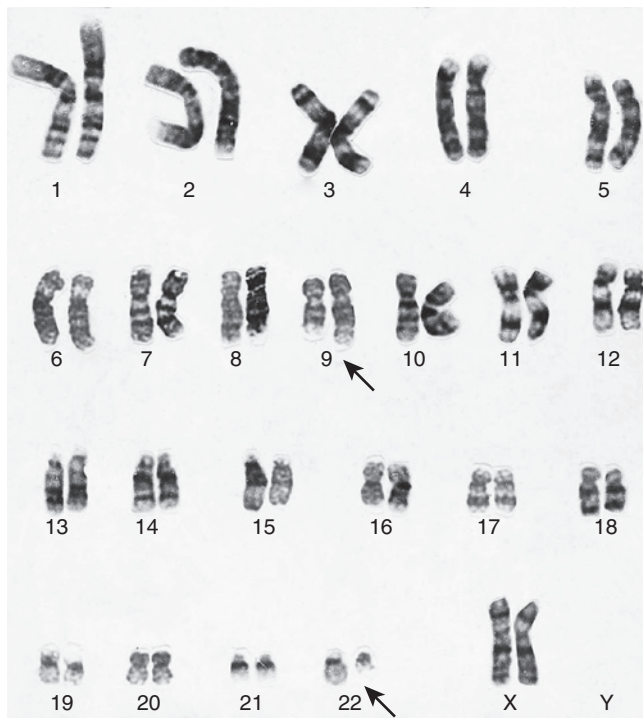
in rearrangements within, or adjacent to, proto-oncogenes. It has been found that chromosomal translocations can lead to novel **chimeric genes** with altered biochemical function, or level of proto-oncogene activity. There are numerous examples of both types, of which chronic myeloid leukemia is an example of the former and Burkitt lymphoma an example of the latter.

### Chronic Myeloid Leukemia

In 1960, investigators in Philadelphia were the first to describe an abnormal chromosome in white blood cells from patients with chronic myeloid leukemia (CML). The abnormal chromosome, referred to as the **Philadelphia**, or **Ph<sup>1</sup>**, **chromosome**, is an acquired abnormality found in blood or bone marrow cells but not in other tissues from these patients. The Ph<sup>1</sup> is a tiny chromosome that is now known to be a chromosome 22 from which long arm material has been reciprocally translocated to and from the long arm of chromosome 9 (Figure 14.4), i.e., t(9;22)(q34;q11). This chromosomal rearrangement is seen in 90% of those with CML. This translocation has been found to transfer the cellular *Abelson (ABL)* oncogene from chromosome 9 into a region of chromosome 22 known as the **break-point cluster**, or *BCR*, region, resulting in a chimeric transcript derived from both the *c-ABL* (70%) and the *BCR* genes. This results in a chimeric gene expressing a **fusion protein** consisting of the BCR protein at the amino end and ABL protein at the carboxy end, which transforms activity.

### Burkitt Lymphoma

An unusual form of neoplasia seen in children in Africa is a lymphoma that involves the jaw, known as Burkitt lymphoma, named after Dennis Burkitt, a medical missionary who first described the condition in 1958. Chromosomal analysis has



**FIGURE 14.4** Karyotype from a patient with chronic myeloid leukemia showing the chromosome 22 (arrow) or Philadelphia chromosome, which has material translocated to the long arm of one of the number 9 chromosomes (arrow).

revealed the majority (90%) of affected children to have a translocation of the *c-MYC* oncogene from the long arm of chromosome 8 on to heavy (H) chain immunoglobulin locus on chromosome 14. Less commonly the *MYC* oncogene is translocated to regions of chromosome 2 or 22, which encode genes for the kappa ( $\kappa$ ) and lambda ( $\lambda$ ) light chains, respectively (pp. 167–168). As a consequence of these translocations, *MYC* comes under the influence of the regulatory sequences of the respective immunoglobulin gene and is overexpressed 10-fold or more.

### Oncogene Amplification

Proto-oncogenes can also be activated by the production of multiple copies of the gene (known as **gene amplification**), a mechanism known to have survival value when cells encounter environmental stress. For example, leukemic cells exposed to the chemotherapeutic agent, methotrexate, acquire resistance to the drug by making multiple copies of the gene for dihydrofolate reductase, the target enzyme for methotrexate. The number of copies of the oncogene per cell can increase several hundred times, with greater amounts of oncoprotein as a consequence. The amplified sequence of DNA in tumor cells gives rise to small extra chromosomes (**double-minute chromosomes**) seen in approximately 10% of tumors, especially in the later stages of the malignant process.

Amplification of specific proto-oncogenes is a feature of certain tumors and is frequently seen with the *MYC* family of genes. For example, *N-MYC* is amplified in approximately 30% of neuroblastomas, but in advanced cases the proportion rises to 50%, where gene amplification can be up to 1000-fold. Human small cell carcinomas of the lung show amplification of *MYC*, *N-MYC*, and *L-MYC*. Also in lung cancer, multiple downstream components of the EGFR-family-signaling pathway, including *CDK5*, *AKT1*, and *SHC1*, are overexpressed. Amplification of *ERBB2 (HER2)*, *MYC*, and *cyclin D1* is a feature in 20% of breast carcinomas, where it correlates with a number of well-established prognostic factors such as lymph node status, estrogen and progesterone receptor status, tumor size, and histological grade. Currently available tests of oncogene activity in breast cancer cover more than 20 genes.

### Detection of Oncogenes by DNA Transfection Studies

The ability of DNA from a human bladder carcinoma cell line to transform a well-established mouse fibroblast cell line called NIH3T3, as demonstrated by the loss of contact inhibition of the cells in culture, or what is known as DNA **transfection**, led to the discovery of the human sequence homologous to the *ras* gene of the Harvey murine sarcoma virus. The human *RAS* gene family consists of three closely related members, *H-RAS*, *K-RAS*, and *N-RAS*. The *RAS* proteins are closely homologous to their viral counterparts and differ from one another only near the carboxy termini. Oncogenicity of the *ras* proto-oncogenes has been shown to arise by acquisition of point mutations in the nucleotide sequence. In approximately 50% of colorectal cancers and 95% of pancreatic cancers, as well as in a proportion of thyroid and lung cancers, a mutation in a *ras* gene can be demonstrated. Similarly, mutations in *BRAF*, which encodes a serine/threonine protein kinase is associated with various cancers, including non-Hodgkin lymphoma, colorectal cancer, malignant melanoma, thyroid carcinoma, non-small cell lung carcinoma, and adenocarcinoma of lung. Both *RAS* and *BRAF* are key constituents of the *RAS*-MAPK signaling pathway,

which affects cell division, differentiation, and secretion. Germline mutations in these genes are associated with neurofibromatosis type 1 (p. 279) and the Noonan/cardio-facio-cutaneous/Costello group of syndromes (pp. 220–221), which are variably associated with an increased tumor risk.

DNA transfection studies have also led to identification of other oncogenes that have not been demonstrated through retroviral studies. These include *MET* (hereditary papillary renal cell carcinoma), *TRK*, *MAS*, and *RET* (multiple endocrine neoplasia type 2, see pp. 119–120; Tables 14.4, 14.9).

### Function of Oncogenes

Oncogene products consistently have a role in the control of cellular proliferation and differentiation in the process known as **intracellular signal transduction**. This is a complex multistep pathway from the cell membrane, through the cytoplasm to the nucleus, involving a variety of types of proto-oncogene product involved in positive and negative feedback loops necessary for accurate cell proliferation and differentiation (Figure 14.5).

Proto-oncogenes are highly conserved, being present in a variety of different species, indicating they are likely to have essential biological functions. They act in three main ways in the process of signal transduction: (1) through phosphorylation of serine, threonine, and tyrosine residues of proteins by the transfer of phosphate groups from ATP; this leads to alteration of the configuration activating the kinase activity of proteins and generating docking sites for target proteins, resulting in signal transduction; (2) through the guanosine diphosphate-

guanosine triphosphate (GDP-GTP) cycle as intermediates relaying the transduction signal from membrane-associated tyrosine kinases to serine threonine kinases (includes the *RAS* family); or (3) through proteins located in the nucleus that control progress through the cell cycle, DNA replication, and the expression of genes.

### Types of Oncogene

#### Growth Factors

Growth factors stimulate cells to grow by binding to growth factor receptors and they govern the transition of a cell from  $G_0$  to the start of the cell cycle (p. 30). The *v-SIS* oncogene, which encodes part of the biologically active platelet-derived growth factor B subunit, acts as a growth factor. When *v-SIS* oncoprotein is added to cell cultures they are transformed, behaving like neoplastic cells—their growth rate increases and they lose contact inhibition. In vivo they form tumors when injected into nude mice. Oncogene products showing homology to fibroblast growth factors include *HST* and *INT-2*, which are amplified in stomach cancers and in malignant melanomas, respectively.

#### Growth Factor Receptors

Many oncogenes encode proteins that form growth factor receptors, possessing tyrosine kinase domains that allow cells to bypass normal control mechanisms. More than 40 different tyrosine kinases are known and there are two main types: those that span the cell membrane (growth factor receptor tyrosine kinases), and those located in the cytoplasm (non-receptor tyrosine kinases). Examples of tyrosine kinases include *ERBB*, which encodes the epidermal growth factor receptor, and the related *ERBB2* (*HER2*) oncogene. Mutations, rearrangements, and amplification of *ERBB2* result in ligand-independent activation, associated with cancer of the stomach, pancreas, and ovary. Mutations in *KIT* and *PDGFRA* occur in sporadic and hereditary gastrointestinal stromal tumor syndrome (known as GIST) as a result of **point mutations**. Germline mutations *alone* do not cause carcinogenesis.

#### Intracellular Signal Transduction Factors

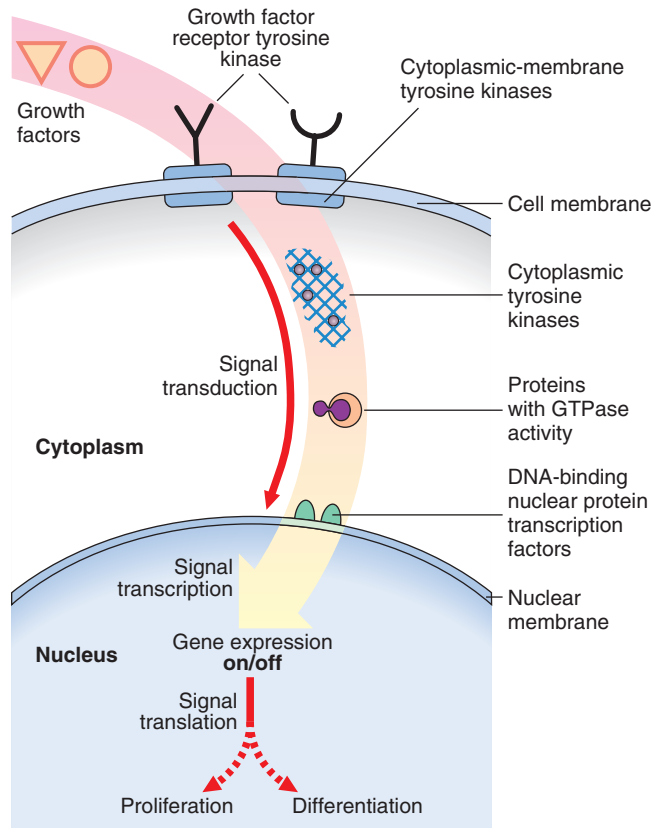
As mentioned in the previous section, there are two forms of intracellular signal transduction—proteins with GTPase activity and cytoplasmic serine threonine kinases (see Figure 14.5). Examples of both are found in the RAS-MAPK pathway, with mutations in *RAS* genes leading to increased or sustained GTPase activity, and mutations in *BRAF* resulting in sustained or increased transmission of a growth-promoting signal to the nucleus.

#### DNA-Binding Nuclear Proteins

These proteins bind to single or double-stranded DNA, usually in the major groove if the binding is sequence-specific. Therefore, they are specific transcription factors that activate or suppress neighboring DNA sequences. Mutations in *c-MYC* are found in many cancers and the *c-MYC* oncoprotein activates expression of many genes through binding enhancer box sequences and recruiting histone acetyltransferases. It also has a direct role in the control of DNA replication and overproduction results in persistent cellular proliferation.

#### Cell-Cycle Factors and Apoptosis

Abnormal regulation of the cell cycle (p. 30), e.g. at  $G_1$  when a cell becomes committed to DNA synthesis in the S phase,



**FIGURE 14.5** Simplified schema of the steps in signal transduction and transcription from cell surface to nucleus. The intracellular pathway amplifies the signal by a cascade that involves one or more of the steps.

or G<sub>2</sub> for cell division in the mitosis (M) phase, can result in uncontrolled cell growth. This may be through growth factors, growth factor receptors, GTPases or nuclear proteins, or loss of inhibitory factors lead to activation of the cyclin-dependent kinases, such as cyclin D1. Alternatively, loss of factors that lead to normal programmed cell death, **apoptosis** (p. 104), can result in the prolonged cell survival as a mechanism of development of some tumors. Activation of the *BCL2* oncogene through chromosomal rearrangements is associated with inhibition of apoptosis, leading to certain types of lymphoma.

### Signal Transduction and the Phakomatoses

**Phakomatosis** derives from the Greek *phakos*, meaning 'lentil' (i.e., 'lentil-shaped object'), originally referring to three conditions with benign lesions—neurofibromatosis, tuberous sclerosis, and von Hippel–Lindau disease. We now include nevoid basal cell carcinoma (Gorlin) syndrome, Cowden disease, familial adenomatous polyposis, Peutz-Jegher syndrome, and juvenile polyposis in this group. The genes for these conditions are known and are normally active within intracellular signal transduction, and their protein products are **tumor suppressors**.

### Tumor Suppressor Genes

The study of human hereditary cancer has identified the existence of **tumor suppressor genes**, which constitute the largest group of hereditary cancer genes.

Studies in the 1960s, which involved fusion of malignant cells with normal cells in culture, resulted in the suppression of the malignant phenotype in the hybrids. Malignancy recurred with the loss of certain chromosomes from the hybrids, suggesting that normal cells contain a gene(s) with tumor suppressor activity which, if lost or inactive, result in malignancy and behaved like a recessive trait. The paradigm for our understanding of the biology of tumor suppressor genes is the eye tumor retinoblastoma (Rb). It is important to appreciate, however, that a germline mutation in a tumor suppressor gene (as with an oncogene) does not by itself provoke carcinogenesis: further somatic mutation at one or more loci is necessary and environmental factors, such as ionizing radiation, may be significant in the process. More than 20 tumor suppressor genes have been identified.

### Retinoblastoma

This is a rare but highly malignant childhood cancer of the developing retinal cells of the eye, usually occurring before 5 years of age (Figure 14.6). Early diagnosis and treatment are associated with a good long-term outcome. Rb can occur either sporadically, the so-called non-hereditary form, or be familial, the so-called hereditary form, which is inherited in an autosomal dominant manner. Non-hereditary cases usually involve only one eye, whereas hereditary cases can be unilateral but are more commonly bilateral or multifocal in one eye. The familial form also tends to present at an earlier age than the sporadic form.

### 'Two-Hit' Hypothesis

In 1971 Knudson studied the epidemiology of both types of Rb and advanced a 'two-hit' hypothesis to explain the occurrence of this rare tumor in patients with and without a positive family history. He proposed that affected individuals with a positive family history had inherited one non-functional gene that was present in all cells of the individual, known as a

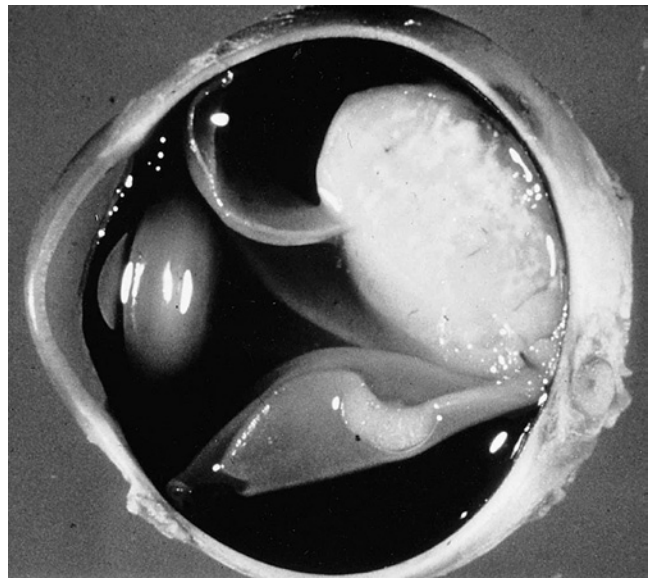


FIGURE 14.6 Section of an eye showing a retinoblastoma in situ.

**germline mutation**, with the second gene at the same locus becoming inactivated somatically in a developing retinal cell (Figure 14.7A). The occurrence of a second mutation was likely given the large number of retinal cells, explaining the autosomal dominant pattern of inheritance. This would also explain the observation that in hereditary Rb the tumors were often (but not always) bilateral and multifocal. In contrast, in the non-heritable or sporadic form, *two* inactivating **somatic mutations** would need to occur independently in the same retinoblast cell (see Figure 14.7B), which was much less likely to occur, explaining the fact that tumors in these patients were often unilateral, unifocal, and occurring at a later age than in the hereditary form. Hence, although the hereditary form of Rb follows an autosomal dominant pattern of inheritance, at the

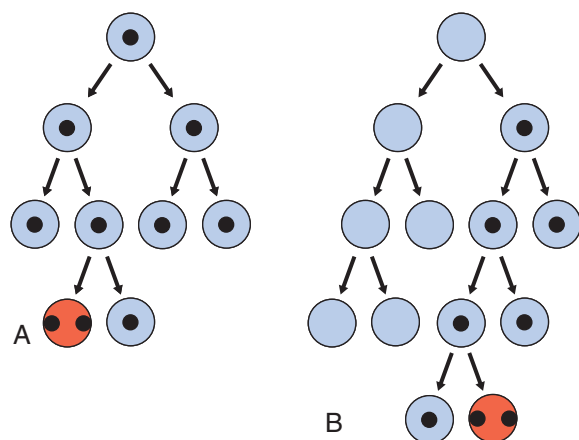
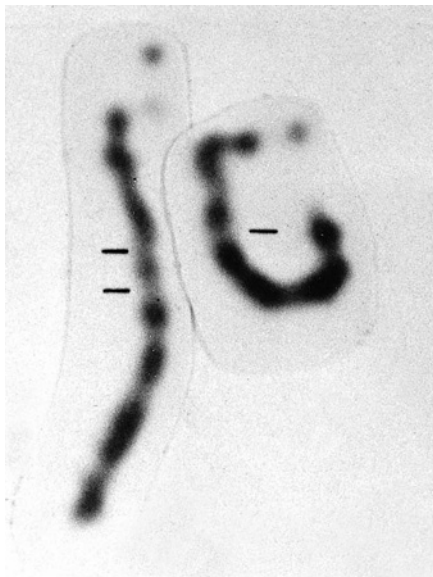


FIGURE 14.7 Retinoblastoma and Knudson's 'two-hit' hypothesis. All cells in the hereditary form (A) have one mutated copy of the gene, *RB1* (i.e., the mutation is in the *germline*). In the non-hereditary form (B) a mutation in *RB1* arises as a post-zygotic (*somatic*) event sometime early in development. The retinoblastoma tumor occurs only when both *RB1* genes are mutated—i.e., after a(nother) *somatic* event, which is more likely to be earlier in life in the hereditary form compared with the non-hereditary form; it is also more likely to give rise to bilateral and multifocal tumors.





**FIGURE 14.8** Two homologs of chromosome 13 from a patient with retinoblastoma showing an interstitial deletion of 13q14 in the right-hand homolog, as indicated.

molecular level it is *recessive* because a tumor occurs only after the loss of both alleles.

Approximately 5% of children presenting with Rb had other physical abnormalities and developmental concerns. Some of these children had a cytogenetically visible interstitial deletion of chromosome 13q, and in due course the common critical region was determined to lie at 13q14 (Figure 14.8). This suggested it could also be the locus for the autosomal dominant familial form of Rb, which was subsequently confirmed by linkage studies.

### Loss of Heterozygosity

By comparing DNA sequences from both peripheral blood and the Rb tumor in children with inherited Rb it was shown that there was loss of an allele at the Rb locus in the tumor material. This is known as **loss of heterozygosity (LOH)**. In Figure 14.9A the mother transmits the Rb gene along with allele 2 at a closely linked marker locus. The father is homozygous for allele 1 at this locus, so the child shows *heterozygosity* at this locus. However, tumor tissue analysis reveals apparent *homozygosity* for allele 2, which is due to loss of the paternally derived allele 1—LOH in the tumor material—consistent with Knudson's 'two-hit' hypothesis.

LOH may occur through several somatic mechanisms, illustrated in Figure 14.9B—loss of a chromosome through mitotic non-disjunction (p. 34), non-disjunction and reduplication, mitotic recombination (leading to homozygosity for the mutant allele), gene conversion, gene deletion, and a point mutation. Observation of consistent cytogenetic rearrangements in other malignancies has led to demonstration of LOH in a number of other cancers (Table 14.2).

### Function of Tumor Suppressor Genes

The Rb paradigm, where absence of the gene product in the homozygous state leads to the development of the tumor, indicates that the normal function of tumor suppressor genes is to suppress inappropriate cell proliferation. Further support for the *RB1* gene acting as a tumor suppressor comes from the

observation that individuals with hereditary Rb have an increased risk of developing second new malignancies later in life, including osteosarcoma, fibrosarcoma, and chondrosarcoma.

### The *RB1* Gene/p105-Rb Protein

The *RB1* gene specifies a 4.7-kilobase (kb) transcript that encodes a nuclear protein called p105-Rb, which associates with DNA and is involved in the regulation of the cell cycle. The protein forms a complex with an oncogene-regulated inhibitor of a transcription factor called *E2F*, and the complex interferes with the ability of *E2F* to activate transcription of some key proteins required for DNA synthesis. When p105-Rb is hyperphosphorylated this complex does form and the cell cycle proceeds to the S phase (p. 30). In the presence of abnormal p105-Rb, retinoblasts fail to differentiate normally. These findings highlight potentially complex mechanisms of interaction between oncogenes, tumor suppressor genes, and the cell cycle in cancer biology.

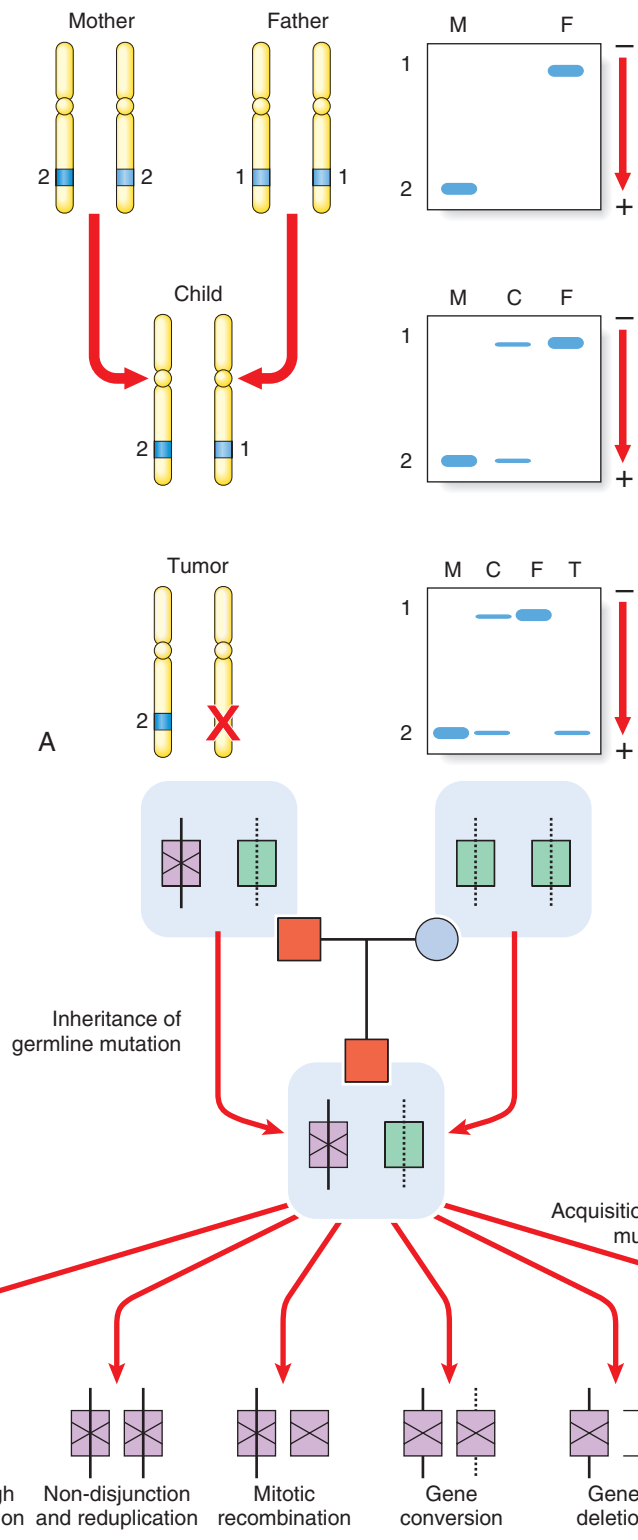
### *TP53*

The p53 protein was first identified as a host cell protein bound to T antigen, the dominant transforming oncogene of the DNA tumor virus SV40. After the murine *p53* gene was cloned it was shown to be able to cooperate with activated *Ras* and act as an oncogene transforming primary rodent cells in vitro, even though the rodent cells expressed the wild-type or normal *p53*. Subsequently, *inactivation* of *p53* was frequently found in murine Friend virus-induced erythroleukemia cells, which led to the proposal that the *TP53* gene was, in fact, a tumor suppressor gene.

In man the *TP53* gene is the most frequently mutated of all the known cancer genes. Some 20% to 25% of breast and

**Table 14.2** Syndromes and Cancers That Show Loss of Heterozygosity and Their Chromosomal Location

Syndrome or Cancer	Chromosomal Location
Retinoblastoma	13q14
Osteosarcoma	13q, 17p
Wilms tumor	11p13, 11p15, 16q
Renal carcinoma	3p25, 17p13
von Hippel–Lindau disease	3p25
Bladder carcinoma	9q21, 11p15, 17p13
Lung carcinoma	3p, 13q14, 17p
Breast carcinoma	11p15, 11q, 13q12, 13q14, 17p13, 17q21
Rhabdomyosarcoma	11p15, 17p13
Hepatoblastoma	5q, 11p15
Gastric cancer	1p, 5q, 7q, 11p, 13q, 17p, 18p
Familial adenomatous polyposis	5q21
Colorectal carcinoma	1p, 5q21, 8p, 17p13, 18q21
Neurofibromatosis I (NF1, von Recklinghausen disease)	17q
Neurofibromatosis II (NF2)	22q
Meningioma	22q
Multiple endocrine neoplasia type I (MEN1)	11q
Melanoma	9p21, 17q
Ovarian	11q25, 16q, 17q
Pancreatic	9p21, 13q14, 17p13
Prostate cancer	1p36, 7q, 8p, 10q, 13q, 16q



**FIGURE 14.9** **A**, Diagrammatic representation of the loss of heterozygosity (LOH) in the development of a tumor. The mother (M) and father (F) are both homozygous for different alleles at the same locus, 2-2 and 1-1, respectively. The child (C) will therefore be constitutionally heterozygous, 1-2. If an analysis of DNA from a tumor at that locus reveals only a single allele, 2, this is consistent with LOH. **B**, Diagrammatic representations of the mechanisms causing the 'second hit' leading to the development of retinoblastoma.

more than 50% of bladder, colon, and lung cancers have been found to have *TP53* mutations, which occur in different codons but are clustered in highly conserved regions in exons 5 to 10. This is in contrast to *TP53* mutations in hepatocellular carcinoma, which occur in a 'hotspot' at codon 249. The base change in this mutated codon, usually G to T, could be the result of an interaction with the carcinogen aflatoxin B<sub>1</sub>, which is associated with liver cancer in China and South Africa, or with the hepatitis B virus that is also implicated as a risk factor in hepatomas. Aflatoxin B<sub>1</sub> is a ubiquitous food-contaminating aflatoxin in these areas and a mutagen in many animal species, inducing G to T substitutions in mutagenesis experiments.

Cancers frequently have a decreased cell death rate through altered **apoptosis**, and a major activator of apoptosis is *TP53*—thus p53 has been coined the 'guardian of the genome'. The p53 protein is a multimeric complex and it functions as a checkpoint control site in the cell cycle at G<sub>1</sub> before the S phase, interacting with other factors, including cyclins and p21, preventing DNA damaged through normal 'wear and tear' from being replicated. Mutant p53 protein monomers are more stable than the normal p53 proteins and can form complexes with the normal wild-type *TP53*, acting in a dominant-negative manner to inactivate it.

### Li-Fraumeni Syndrome

Because mutations in *TP53* appear to be a common event in the genesis of many cancers, an inherited or germline mutation of *TP53* would be expected to have serious consequences, and indeed causes **Li-Fraumeni syndrome**. Members of families with this rare syndrome, inherited as an autosomal dominant trait, are highly susceptible to a variety of malignancies at an early age, including adrenal carcinomas, sarcomas, and breast cancer. Point mutations in highly conserved regions of the *TP53* gene (codons 245 to 258) are common, with tumor analysis revealing loss of the normal allele.

## Epigenetics and Cancer

Much of this chapter discusses familial cancer syndromes that follow Mendelian inheritance, characterized by mutations in disease-specific genes. However, no discussion about cancer genetics is complete without considering epigenetic mechanisms. As discussed in [Chapter 9 \(p. 121\)](#), **epigenetics** refers to heritable changes to gene expression that are *not* due to differences in the genetic code. Such gene expression can be transmitted stably through cell divisions, both mitosis and meiosis. In cancer, much is now known about alterations to methylation status of the genome, both *hypomethylation* and *hypermethylation*, and in this section we also discuss telomere length and cancer.

### DNA Methylation and Genomic Imprinting

The methylation of DNA is an **epigenetic** phenomenon ([p. 121](#)), and is the mechanism responsible for X-inactivation ([p. 122](#)) and genomic imprinting ([p. 77](#)). Methylation of DNA has the effect of silencing gene expression and maintaining stability of the genome, especially in areas where there is a vast quantity of repetitive DNA (heterochromatin), which might otherwise become erroneously involved in recombination events leading to altered regulation of adjacent genes. The relevance of this for cancer emerged in 1983 when studies showed that the genomes of cancer cells were *hypomethylated* compared with those of normal cells, primarily within

repetitive DNA. This **loss of imprinting (LOI)** may lead to activation of an allele that is normally silent, and hence the high expression of a product that confers advantageous cellular growth. This appears to be an early event in many cancers and may correlate with disease severity. Chromosomal instability is strongly associated with increased tumor frequency, which is a feature of the 'chromosome breakage' syndromes ([p. 250](#)), associated with a significant increased cancer risk, particularly leukemia and lymphoma.

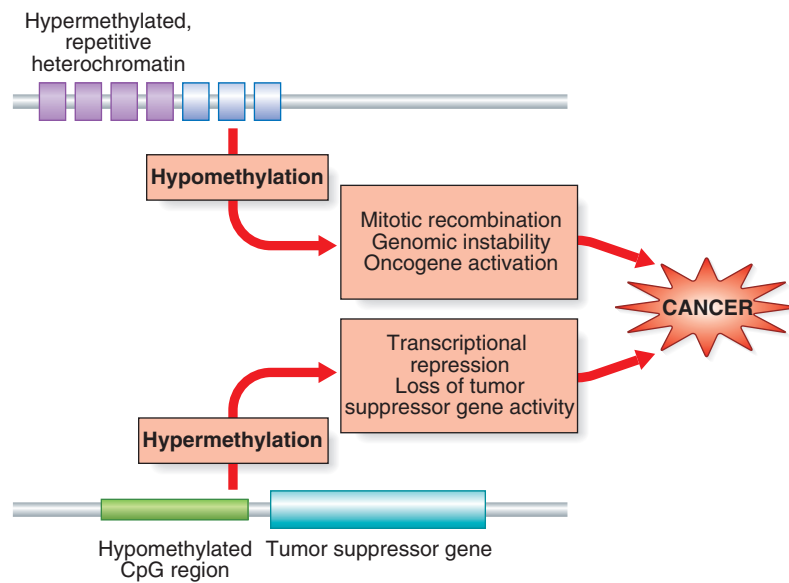
LOI and removal of normal gene silencing may lead to oncogene activation, and hence cancer risk. LOI has been studied extensively at the *IGF2/H19* locus on chromosome 11p15.5, previously discussed in [Chapter 6 \(p. 79\)](#). Insulin-like growth factor 2 (*IGF2*) and *H19* are normally expressed from the paternal and maternal alleles, respectively (see [Figure 6.27](#)), but reduced silencing of the maternal allele (i.e., *hypomethylation*) results in increased *IGF2* expression. This is a common LOI event across a wide range of common tumor types (e.g., lung, liver, colon, ovary), as well as Wilms tumor in which it was first identified.

Just as *hypomethylation* may lead to activation of oncogenes, the opposite effect of *hypermethylation* may also give rise to an increased cancer risk, in this case through silencing of tumor suppressor genes. Aberrant *hypermethylation* usually affects CpG nucleotide islands (C and G adjacent to each p, phosphodiester, bond), which are mostly unmethylated in somatic cells. This results in changes in chromatin structure (*hypocetylation* of histone) that effectively silence transcription. When genes involved in cell regulatory activity are silenced, cells have a growth advantage. Early *hypermethylation* has been detected in colonic cancer. The effects of altered methylation leading to cancer are summarized in [Figure 14.10](#), although the mechanism(s) that initiate the processes are poorly understood.

### Telomere Length and Cancer

Telomeres are specialized chromatin structures at the tips of chromosomes ([p. 25](#)) and have a protective function. The sequence of DNA is specific and consists of multiple double-stranded tandem repeats as follows: TTAGGG. This sequence is approximately 10 to 15 kb long in human cells and is bound by specific proteins. It is also the substrate for telomerase, an enzyme that can lengthen the telomeres in those cells in which it is expressed. The final stretch of DNA at the very tip of the telomere is a single-stranded overhang of 150 to 200 nucleotides. Telomerase recognizes the 3' end of the overhang, allowing lengthening to proceed.

Every cell division appears to result in the loss of some TTAGGG repeats because conventional DNA polymerases cannot replicate a linear chromosome in its entirety, known as the 'end-replication problem'. This progressive loss of telomere length is a form of cellular clock believed to be linked to both aging and human disease. This relationship is displayed graphically in [Figure 14.11](#). When telomeres reach a critically short length, there is loss of protection and a consequence is chromosomal, and therefore genomic, instability, which reduces cell viability. Short telomeres are a feature of the premature aging syndromes, such as ataxia telangiectasia, and other chromosome breakage disorders ([p. 250](#)), associated with early onset cancer. It appears that the *rate* of telomere shortening is markedly increased in these conditions, so that cells and tissues literally 'age' more quickly. However, some cancer cells express high levels of telomerase, so maintaining cell viability. Most



**FIGURE 14.10** Methylation of DNA and cancer. The top schema shows a region of hypermethylated repetitive DNA sequence (heterochromatin). When this loses its methylation imprint, chromosome instability may result, which may lead to activation of oncogene(s). In the lower panel, hypomethylated stretches of CpG sequence (p. 185) become methylated, resulting in transcriptional suppression of tumor suppressor and cell regulatory genes.

metastatic tissue contains telomerase-positive cells, suggesting that telomerase is required to sustain such growth, but cancer cells generally have relatively short telomeres. Thus, telomerase activation in cancer rescues short telomeres *and* perpetuates genomically unstable cells.

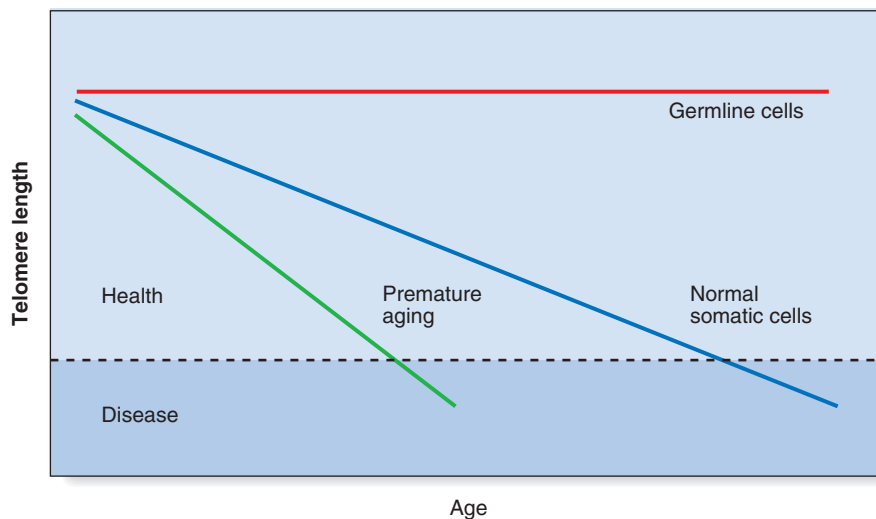
### Genetics of Common Cancers

Approximately 5% of colorectal and breast cancers arise as a result of an inherited cancer susceptibility gene. A similar proportion of many other cancers are due to inherited predisposing genetic factors, but there are some notable exceptions in which only a very low incidence of a dominantly inherited

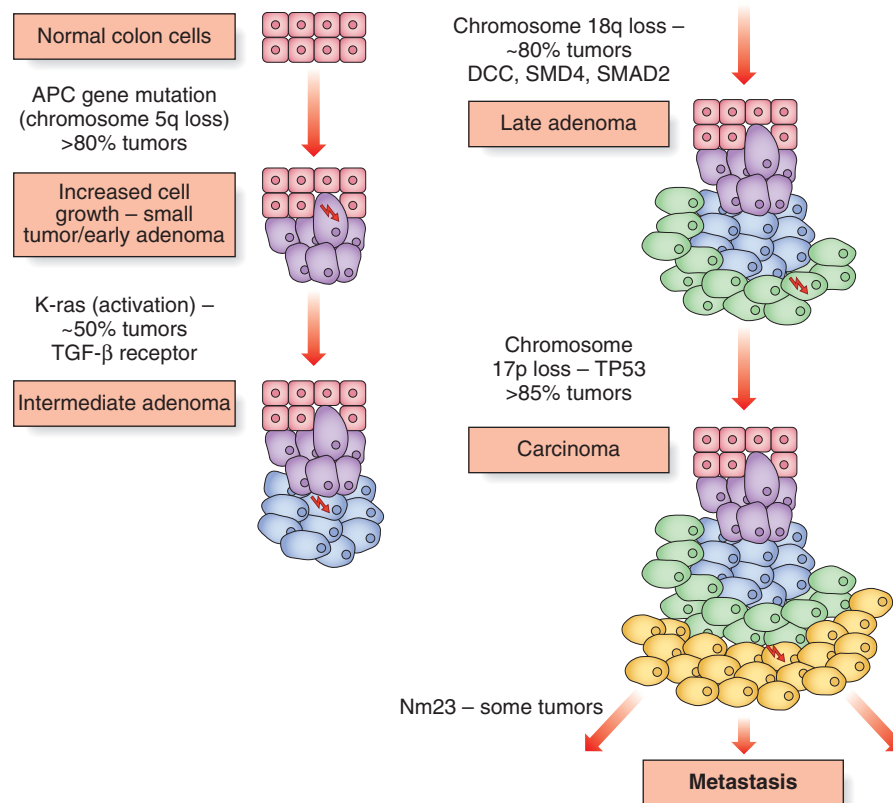
predisposition is recorded. These include the lung and cervix, as well as leukemias, lymphomas, and sarcomas. In these external agents or stimuli, and/or stochastic genetic events, are presumed to be the main factors. Nevertheless, studies of the common cancers—colorectal and breast—have provided great insights into the genetics of cancer.

### Colorectal Cancer (CRC)

Approximately 1 in 40 people in the developed countries of Western Europe and North America will develop cancer of the bowel or colon, and an understanding of the development of colorectal tumorigenesis has shed light on carcinogenesis more generally.



**FIGURE 14.11** Telomere length over age, in normal life and premature aging syndromes. The only cells in the body that maintain telomere length throughout life, and have high levels of telomerase, are those of the germline. Somatic cells, in the absence of disease, undergo a slowly progressive decrease in telomere length throughout life, so that disease and cancer become an increasing risk in the elderly. In premature aging syndromes, the process of telomere shortening is accelerated, and the risk of cancer becomes high from early adult life onward.



**FIGURE 14.12** The development of colorectal cancer is a multistage process of accumulating genetic errors in cells. The *red arrows* represent a new critical mutation event, followed by clonal expansion. At the stage of carcinoma, the proliferating cells contain all the genetic errors that have accumulated.

### Multistage Process of Carcinogenesis

The majority of CRCs are thought to develop from ‘benign’ adenomas, though only a small proportion of adenomas proceed to invasive cancer. Histologically, adenomatous polyps smaller than 1 cm in diameter rarely contain areas of carcinomatous change, whereas the risk of carcinomatous change increases to 5% to 10% when an adenoma reaches 2 cm in diameter. The transition from a small adenomatous polyp to an invasive cancer is thought to take between 5 and 10 years. Adenomatous polyps less than 1 cm in diameter have mutations in the *RAS* gene in less than 10% of cases. As the size of the polyp increases to between 1 and 2 cm, the prevalence of *RAS* gene mutations may reach 40%, rising to approximately 50% in full-blown CRCs.

Similarly, allele loss of chromosome 5 markers occurs in approximately 40% of adenomatous polyps and 70% of carcinomas. Deletions on chromosome 17p in the region containing the *TP53* gene occur in more than 75% of carcinomas, but this is an uncommon finding in small or intermediate-sized polyps. A region on 18q is deleted in approximately 10% of small adenomas, rising to almost 50% when the adenoma shows foci of invasive carcinoma, and in more than 70% of carcinomas (Figure 14.12). Genes at this locus include deleted in colorectal cancer (*DCC*), *SMAD2*, and *SMAD4*, the latter being part of the transforming growth factor- $\beta$  (TGF- $\beta$ ) pathway (p. 105). In some CRCs mutations in the *TGF- $\beta$*  receptor gene have been identified. The *DCC* gene shows homology with the family of genes encoding cell adhesion molecules—and cell-cell and cell-basement membrane interactions are lost in overt malignancy. *DCC* is expressed in

normal colonic mucosa but is either reduced or absent in colorectal carcinomas.

It appears that mutations of the *RAS* and *TP53* genes and LOH on 5q and 18q accumulate during the transition from a small ‘benign’ adenoma to carcinoma. The accumulation of alterations, rather than the sequence, appears to be crucial. More than one of these four alterations is seen in only 7% of small, early adenomas. Two or more alterations are seen with increasing frequency when adenomas progress in size and show histological features of malignancy. More than 90% of carcinomas show two or more alterations, and approximately 40% show three.

The multistage process of the development of cancer is likely to be an oversimplification. The distinction between oncogenes and tumor suppressor genes (Table 14.3) has not

**Table 14.3** Some Familial Cancers or Cancer Syndromes Due to Tumor Suppressor Mutations

Disorder	Gene	Locus
Retinoblastoma	<i>RB1</i>	13q14
Familial adenomatous polyposis	<i>APC</i>	5q31
Li-Fraumeni syndrome	<i>TP53</i>	17p13
von Hippel-Lindau syndrome	<i>VHL</i>	3p25-26
Multiple endocrine neoplasia type II	<i>RET</i>	10q11.2
Breast-ovarian cancer	<i>BRCA1</i>	17q21
Breast cancer	<i>BRCA2</i>	13q12-13
Gastric cancer	<i>CDH1</i>	16q22.1
Wilms tumor	<i>WT1</i>	11p13
Neurofibromatosis I	<i>NF1</i>	17q12-22

always been clear-cut—e.g., the *RET* oncogene and *MEN2* (p. 113). In addition, the same mutation in some of the inherited cancer syndromes (p. 189) can result in cancers at different sites in different individuals, which might be the consequence of variable somatic mutations, variation in the background (germline) genetic make-up, or separate environmental exposures.

### DNA Tumor Profiling and Mutation Signatures

The advent of next generation sequencing has dramatically enhanced our understanding of the genetics of cancer and a global effort is underway to assemble big data on the cancer genome, curated through sites such as the Catalogue of Somatic Mutations in Cancer (COSMIC). Whereas cytogenetic and microarray-CGH techniques highlighted the significance of multiple somatic, and often recurring, genetic events in tumorigenesis, such as disruptive chromosomal rearrangements and allele loss, DNA profiling of tumor tissue is taking cancer biology, treatment, monitoring and surveillance to an entirely new level. The multiple mutational events that take place can be schematically presented in the form depicted in Figure 14.13.

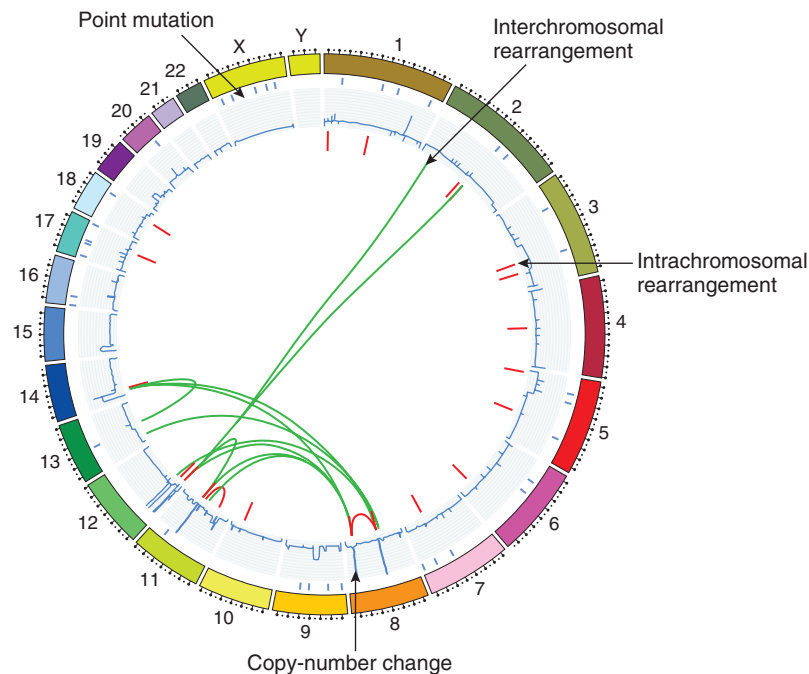
We are learning from this technology that vast numbers (often thousands) of mutational events occur in tumor tissue when compared with analysis of germline DNA in an affected individual, and there are likely to be some similarities as well as many differences between the DNA profile of tumors from two people, even though the histological diagnosis is the same. This has given rise to the notion of ‘signatures’ of mutational processes—derived from the observation that different mutational processes appear to be associated with different

combinations of mutation types. Many of the differences between the profiles of tumors comprise so-called ‘passenger’ mutations, i.e. variants that are generated but relatively non-contributory in driving cellular proliferation.

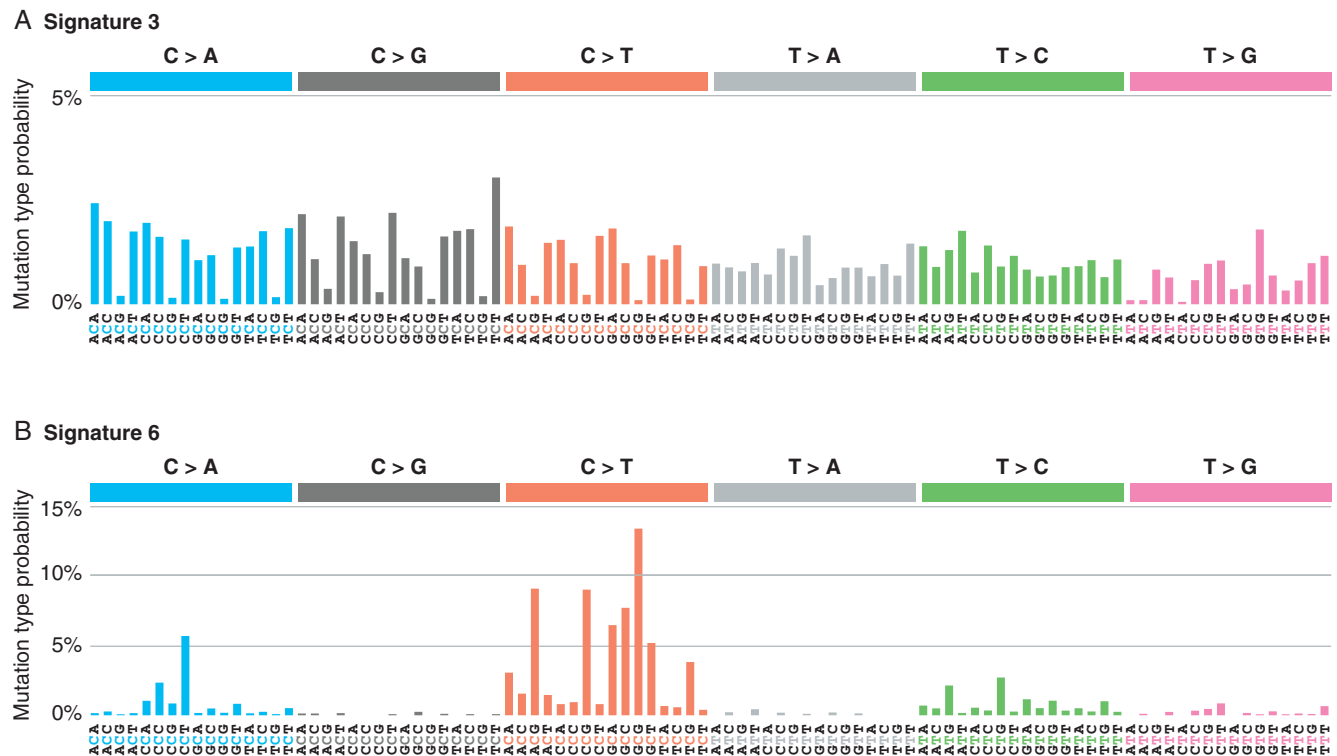
In principle all classes of mutation, e.g. substitutions, indels, rearrangements, and others, can be incorporated into the genomic features that define a mutational signature. However, to date signatures have been most clearly established for the six classes of base substitution—C>A, C>G, C>T, T>A, T>C, T>G. COSMIC currently lists 30 signatures based on the pattern of these substitutions in various cancer genomes that have been studied, and two examples are shown in Figure 14.14. As more is learned about the specificity and sensitivity of molecular signatures the hope and expectation is that the diagnosis, metastatic potential, and indeed treatment options, will improve, thus bringing this field of genomics into the realm of personalized, or *precision*, medicine.

### Circulating Tumor DNA (ctDNA)

Another rapidly emerging application of next generation sequencing in cancer genomics is the detection of circulating tumor DNA (ctDNA) in patients with metastatic disease. Tumor DNA may be present in the plasma of a cancer patient either as circulating tumor cells (CTC) or cell free DNA. It has been shown that the frequency of CTCs and ctDNA in plasma correlates with the stage of cancer in the patient, i.e. the more advanced the cancer, the higher the frequency of CTC and ctDNA; this also correlates with survival. This principle is well recognized in monitoring the response to treatment in CML (p. 180), whereby the presence and load of the specific chimeric *ABL* fusion product is monitored. However, massively parallel sequencing (MPS)—as opposed to some form of traditional PCR—facilitates the detection and



**FIGURE 14.13** DNA profiling in a single cancer genome. Part of the catalog of somatic mutations in a cell line from a small-cell lung cancer. Individual chromosomes are depicted on the outer circle followed by concentric tracks for point mutation, copy number and rearrangement data relative to mapping position in the genome. Arrows indicate examples of the various types of somatic mutation present in this cancer genome. (Reproduced with permission from Stratton MR, Campbell PJ, Futreal PA 2009 *The cancer genome*. *Nature* 458:719–724.)



**FIGURE 14.14** Examples of mutational signatures displayed on the basis of the trinucleotide frequency of the human genome. The display uses a 96 substitution classification defined by the substitution class and the sequence context immediately 3' and 5' to the mutated base. The probability for each of the six types of substitutions and the mutated bases are displayed in different colors as vertical bars. The mutation types appear on the horizontal axis, and percentage of mutations attributed to a specific mutation on the vertical axis. **A.** Signature 3. Signature 3 is strongly associated with germline and somatic *BRCA1* and *BRCA2* mutations in breast, pancreatic, and ovarian cancers. It is also associated with increased numbers of large (>3 bp) insertions and deletions. It is thought to be associated with failure of DNA double-strand break-repair by homologous recombination. **B.** Signature 6. Signature 6 is most common in colorectal and uterine cancers, and associated with defective DNA mismatch repair, as in microsatellite unstable tumors. It is also associated with large numbers of small (<3 bp) insertions and deletions at mono/polynucleotide repeats. (Adapted from Alexandrov LB, Nik-Zainal S, Wedge DC et al 2013 Signatures of mutational processes in human cancer. *Nature* 500:415–421, and COSMIC [<http://cancer.sanger.ac.uk/cosmic/signatures>].)

monitoring of the numerous genetic alterations occurring in cancer tissue. The technical challenge derives from the fact that circulating DNA is present in fragments with an average length of 140–170 bp, is present in just a few thousand amplifiable copies per mL of blood, and of this only a fraction may be clinically relevant. A technique called tagged-amplicon deep sequencing (TAm-Seq) allows for the amplification and deep sequencing of genomic regions spanning thousands of bases, even from individual copies of fragmented DNA.

In a clinical setting one approach is to use MPS on solid tumor samples to initially identify specific genomic rearrangements and mutations, and these can then be identified in plasma; another is to use TAm-Seq to search for mutations of genes commonly found in cancer, such as *TP53*, *EGFR*, *PIK3CA*, and *KRAS* in ovarian disease. An application of the technique can also detect and quantify commonly occurring deletions through targeting multiple heterozygous SNPs. These methods of characterizing and monitoring cancer have the potential advantage of providing a more comprehensive profile because individual tumors may harbor different clonal expansions of abnormal tissue which are not always captured in a biopsy. This exciting advance is set to change the way we screen for cancer in the future, monitor the response to treatment (Figure 14.15), as well as inform the treatment protocol.

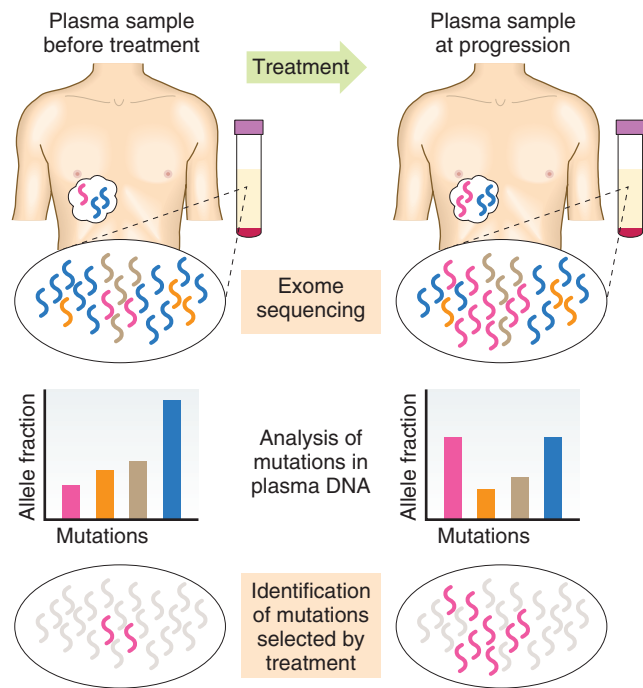
## Inherited Cancer Syndromes

Familial cancer is a major component of the work of a clinical geneticist and comprises both common and rare conditions (Table 14.4). We begin with the condition which for many years was the best known example of an inherited cancer syndrome.

### Familial Adenomatous Polyposis (FAP)

Approximately 1% of persons who develop CRC do so through inheriting the altered gene for FAP. Affected individuals develop numerous polyps of the large bowel, which can involve its entirety (Figure 14.16). There is a high risk of carcinomatous change taking place in these polyps, with more than 90% of persons with FAP eventually developing bowel cancer. Gastric and upper gastrointestinal cancer is also a significant risk in FAP, as we know from the improved survival of those who have had preventive colorectal surgery. They are also at risk of desmoid tumors and cutaneous sebaceous cysts and lipomas.

The identification of an individual with FAP and an interstitial deletion of chromosome 5q21 led to the demonstration of linkage of FAP to DNA markers in that region, followed by isolation of the adenomatous polyposis coli (*APC*) gene. Analyses of the *APC*-linked cancers from people with FAP have



**FIGURE 14.15** Identification of treatment-associated mutational changes from exome sequencing of serial plasma samples. This diagram illustrates a study in which plasma was collected prior to treatment for advanced cancer, and then at multiple time-points during treatment. Exome sequencing was performed on circulating tumor DNA (ctDNA) from plasma, and germline DNA. The abundance (allele fraction) of mutations in ctDNA at different time points was compared, and showed that some mutations significantly increased in abundance, which may indicate selection pressures associated with specific treatments. Some of the mutations identified were known to promote tumor growth and drug resistance, whilst others were of unknown significance. Studies of this kind across large cohorts should lead to the identification of genes and pathways with recurrent mutations.

shown LOH, suggesting a similar mechanism of gene action at the cellular level. In non-hereditary CRC LOH at 5q21 in the tumor material is common, with *APC* being deleted in 40% and 70% of sporadically occurring adenomas and carcinomas of the colon respectively.

### Lynch Syndrome (Hereditary Non-Polyposis Colorectal Cancer—HNPCC)

A proportion of individuals with familial CRC may have a small number of polyps, and the cancers occur more frequently in the proximal, or right side, of the colon, which is sometimes called 'site-specific' colonic cancer. The average age of onset for colonic cancer in this condition is the mid-forties. This familial cancer-predisposing syndrome is inherited as an autosomal dominant disorder and there is now a preference to return to the original eponymous designation of Lynch syndrome (LS) rather than HNPCC. There is also a risk of small intestinal cancers, including stomach, endometrial cancer, and a variety of others.

#### DNA Mismatch Repair Genes

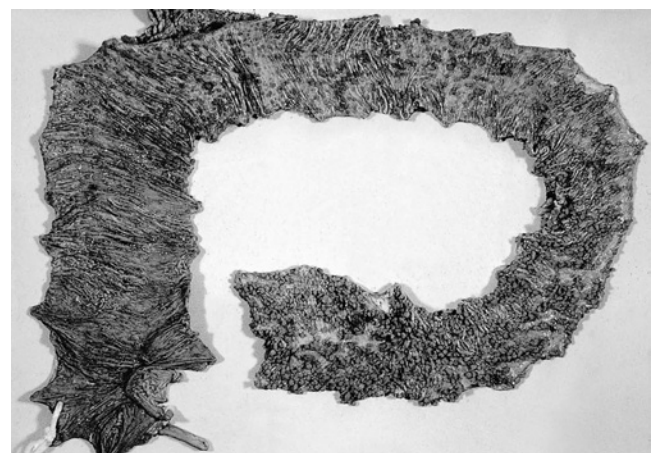
When looking for LOH, comparison of polymorphic microsatellite markers in tumor tissue and constitutional cells in persons with LS somewhat surprisingly revealed the presence of new,

rather than fewer, alleles in the DNA from tumor tissue. In contrast to the site-specific chromosome rearrangements seen with certain malignancies (see Table 14.2), this phenomenon, known as **microsatellite instability (MSI)**, is generalized, occurring with all microsatellite markers analyzed, irrespective of their chromosomal location.

This phenomenon was recognized to be similar to that seen in association with mutations in genes known as mutator genes, such as the *MutHLS* genes in yeast and *Escherichia coli*. In addition, the human homolog of the mutator genes were located in regions of the human chromosomes to which LS had previously been mapped, leading to rapid cloning of the genes responsible for LS in humans (Table 14.5). The mutator genes code for a system of 'proof-reading' enzymes and are known as **mismatch repair genes**, which detect mismatched base pairs arising through errors in DNA replication or acquired causes (e.g., mutagens). The place of the *TACSTD1* gene is unusual. It lies directly upstream of *MSH2* and, when the last exons of the gene are deleted, transcription of *TACSTD1* extends into *MSH2*, causing epigenetic inactivation of the *MSH2* allele. However, deletions in this gene appear to be a rare cause of LS.

Individuals who inherit a mutation in one of the mismatch repair genes are constitutionally heterozygous for a loss-of-function mutation (p. 20). Loss of function of the second copy through any of the mechanisms discussed in relation to LOH (p. 183, and Figure 14.9) results in defective mismatch repair leading to an increased mutation rate associated with an increased risk of developing malignancy. Certain germline mutations, however, seem to have dominant-negative effects (p. 20). Although LS accounts for a small proportion of CRC, estimated as 2% to 4% overall, approximately 15% of all CRCs exhibit MSI, the proportion being greater in tumors from persons who developed CRC at a younger age. Some of these individuals will have inherited constitutional mutations in one of the mismatch repair genes in the absence of a family history of CRC. In addition, for women with a constitutional mismatch repair gene mutation, the lifetime risk of endometrial cancer is up to 50%.

Analysis of tumor DNA for evidence of MSI has become a routine first test in cases where a diagnosis of LS is a possibility. High levels of MSI are suggestive of the presence of LS-related



**FIGURE 14.16** Large bowel from a person with polyposis coli opened up to show multiple polyps throughout the colon. (Courtesy Mr. P. Finan, Department of Surgery, General Infirmary, Leeds.)



**Table 14.4** Inherited Family Cancer Syndromes, Mode of Inheritance, Gene Responsible and Chromosomal Site

Syndrome	Mode of Inheritance	Gene	Chromosomal Site	Main Cancer(s)
Breast/ovary families	AD	<i>BRCA1</i>	17q21	Breast, ovary, colon, prostate
Breast (+ ovary) families	AD	<i>BRCA2</i>	13q12	Breast, ovary
Familial adenomatous polyposis	AD	<i>APC</i>	5q21	Colorectal, duodenal, thyroid
Turcot syndrome	AD	<i>APC</i>	5q21	Colorectal, brain
Lynch syndrome	AD	<i>hMLH1</i>	3p21	Colorectal, endometrial, urinary tract, ovarian, gastric, small bowel, hepatobiliary
		<i>hMSH2</i>	2p22-21	
		<i>hMLH1</i>	3p21	
		<i>hMSH2</i>	2p22-21	
		<i>hMSH6</i>	2p16	
		<i>hPMS1</i>	2q31	
MYH polyposis	AR	<i>MYH</i>	1p33	As Lynch syndrome plus sebaceous tumors, laryngeal
		<i>hMSH2</i>	2p22-21	
		<i>SMAD4/DPC4</i>	18q21.1	
Muir-Torré syndrome	AD	<i>SMAD4/DPC4</i>	18q21.1	Colorectal
Juvenile polyposis	AD	<i>BMPR1A</i>	10q22	
Peutz-Jegher syndrome	AD	<i>STK11</i>	19p13.3	Gastrointestinal, breast, uterus, ovary, testis
Cowden disease	AD	<i>PTEN</i>	10q23	Breast (females), thyroid (papillary), testicular (seminoma)
Familial retinoblastoma	AD	<i>RB1</i>	13q14	Retinoblastoma
Li-Fraumeni syndrome	AD	<i>TP53</i>	17p13	Sarcoma, breast, brain, leukemia, adrenal cortex
<b>Multiple Endocrine Neoplasia (MEN)</b>				
Type I (MEN1)	AD	<i>MEN1</i>	11q13	Parathyroid, thyroid, anterior pituitary, pancreatic islet cells, adrenal
Type II (MEN2)	AD	<i>RET</i>	10q11.2	Thyroid (medullary), pheochromocytoma
von Hippel-Lindau disease	AD	<i>VHL</i>	3p25-26	CNS hemangioblastoma, renal, pancreatic, pheochromocytoma
Gorlin (nevoid basal cell carcinoma) syndrome	AD	<i>PTCH</i>	9q22	Basal cell carcinomas, syndrome medulloblastoma, ovarian fibromas, (odontogenic keratocysts)
Birt-Hogg-Dubé syndrome	AD	<i>FLCN</i>	17p11.2	Renal
Dysplastic nevus syndrome	AD	<i>CMM1</i>	1p	Melanoma (familial atypical mole melanoma, FAMM)

AD, Autosomal dominant; AR, autosomal recessive; CNS, central nervous system.

mutations in the tumor, some of which will be somatic in origin whereas in others there will be a germline mutation plus a 'second hit' in the normal allele. An additional technique, **immunohistochemistry (IHC)**, is very useful as an investigation to discriminate those cases suitable for direct mutation analysis. Taking paraffin-embedded tumor tissue, loss of expression of specific mismatch repair genes can be tested using antibodies against the proteins hMSH2, hMLH1, hMSH6, and hPMS2. Where tumor cells fail to stain (in contrast to surrounding

normal cells), a loss of expression of that protein has occurred and direct gene mutation analysis can be justified.

### Other Polyposis Syndromes

Although isolated intestinal polyps are common, occurring in approximately 1% of children, there are familial forms of multiple polyposis that are distinct from FAP but show heterogeneity.

### MYH Polyposis

In one large study, nearly 20% of familial polyposis cases showed neither dominant inheritance nor evidence of an *APC* gene mutation. Of these families, greater than 20% were found to have mutations in the *MYH* gene, and affected individuals were compound heterozygotes. In contrast to the other polyposis conditions described in the following section, MYH polyposis is an autosomal recessive trait, thus significantly affecting genetic counseling as well as the need for screening in the wider family. The gene, located on chromosome band 1p33, is the human homolog of *mutY* in *E. coli*. This bacterial mismatch repair operates in conjunction with *mutM* to correct A/G and A/C base-pair mismatches. In tumors studied, an excess of G:C to T:A transversions was observed in the *APC* gene. Mutations that effectively knock out the *MYH* gene therefore lead to defects in the base excision-repair pathway; this is a form of DNA mismatch repair that, unusually, follows autosomal recessive inheritance.

**Table 14.5** Mismatch Repair Genes Associated With Lynch Syndrome

Human Gene	Chromosomal Locus	<i>E. coli</i> Homolog	HNPCC (%)
<i>hMSH2</i>	2p22-21	MutS	31
<i>hMSH6</i>	2p16	MutS	Rare
<i>hMLH1</i>	3p21	MutL	33
<i>hPMS1</i>	2q31	MutL	Rare
<i>hPMS2</i>	7p22	MutL	4
<i>TACSTD1</i> (deletions affect <i>hMSH2</i> , which is immediately downstream)	2p21		Rare
Undetermined loci			~30

### Juvenile Polyposis Syndrome

Autosomal dominant transmission is well described for a rare form of juvenile polyposis that may present in a variety of ways, including bleeding with anemia, pain, intussusception, and failure to thrive. The polyps carry an approximate 13-fold increased cancer risk and, once diagnosed, regular surveillance and polypectomy should be undertaken. The average age at diagnosis of cancer is in the third decade, so that colectomy in adult life may be advisable. Two genes have been identified as causative: *SMAD4* (18q) and *BMPRIA* (10q22). Both are components of the TGF- $\beta$  signaling pathway (p. 105) and *SMAD4* mutations, which account for approximately 60% of cases, appear to carry a higher malignancy potential and the possibility of large numbers of gastric polyps.

### Cowden (PTEN) Disease

Also known as **multiple hamartoma syndrome**, Cowden disease is autosomal dominant but very variable. Gastrointestinal polyps are found in about half of the cases and are generally benign hamartomas or adenomas. Multiple lipomas occur with similar frequency and the oral mucosa may have a ‘cobblestone’ appearance (Figure 14.17). Significant macrocephaly is very common in this condition. Importantly, however, there is a high incidence (50%) of breast cancer in females, usually occurring at a young age, and papillary thyroid carcinoma affects approximately 7% of the patients. Testicular seminoma can occur in males. Mutations in the tumor suppressor *PTEN* gene on chromosome 10q23, encoding a tyrosine phosphatase, cause Cowden disease. A related phenotype with many overlapping features, which glories in the eponymous name Bannayan-Riley-Ruvalcaba syndrome, has also been shown to be due to mutations in *PTEN* in a large proportion of cases.

### Peutz-Jegher Syndrome (PJS)

Also autosomal dominant, this condition is characterized by the presence of dark melanin spots on the lips, around the mouth (Figure 14.18), on the palms and plantar areas, and other extremities. These are usually present in childhood and can fade in adult life. Patients often present with colicky abdominal pain from childhood due to the development of multiple polyps that occur throughout the gastrointestinal tract, although



**FIGURE 14.17** Cowden disease. The so-called ‘cobblestone’ appearance of the tongue.



**FIGURE 14.18** Pigmented melanin spots affecting the oral mucosa of a child with Peutz-Jegher syndrome, which are usually more prominent in childhood compared with adult life. Affected individuals are at risk of multiple polypoid hamartomas throughout the gastrointestinal tract, which may undergo malignant change.

they are most common in the small intestine. These are hamartomas but there is a significant risk of malignant transformation. There is an increased risk of cancers at other sites, particularly breast, uterus, ovary, and testis, and these tend to occur in early adult life. Regular screening for these cancers throughout life, from early adulthood, is warranted. Mutations in a serine threonine kinase gene, *STK11* (19p13), cause PJS.

### Breast Cancer

This is the most common cancer in women, with nearly 50,000 new diagnoses made annually in the UK—a quarter of a million in the United States; approximately 1 in 8 women in Western societies will develop the disease in their lifetime. Some 15% to 20% of women with breast cancer have a positive family history of the disorder and the risk to a female relative is greater when one or more of the following factors is present: (1) a clustering of cases in close female relatives; (2) early age (<50 years) at presentation; (3) the occurrence of bilateral disease; (4) and the additional occurrence of ovarian cancer; (5) a paternal (or close male relative) history of breast cancer.

Molecular studies of breast cancer tumors have revealed many regions of LOH, including (in descending order of frequency) 7q, 16q, 13q, 17p, 8p, 21q, 3p, 18q, 2q, and 19p, as well as several other regions with known candidate genes or fragile sites. With respect to cell growth and proliferation the genes and pathways that are altered include the oncogenes *HER2*, *c-MYC*, and *RAS*, the estrogen receptor genes, and the genes for cell cyclin D1 and E. An oncogene called *EMSY* (aka *C11ORF30*) was found to be amplified in 13% of breast cancers and 17% of ovarian cancers, and was ascertained when looking for DNA sequences that interact with *BRCA2*—its normal function may be to switch off *BRCA2*. In addition, the tumor suppressor genes *RB*, *TP53*, and *PTEN*, and the breast cancer susceptibility genes *BRCA1* and *BRCA2*, are frequently implicated.

In practical terms, in a clinical pathological setting, the key protein markers evaluated are *HER2*, estrogen receptors (ER), and progesterone receptors (PR). If these are all negative it means that tumor growth is not supported by the hormones

estrogen and progesterone, and will not respond to therapies such as tamoxifen or Herceptin, but they tend to be more aggressive tumors. However, there is much hope in a group of drugs called PARP inhibitors—PARP is a protein required by cancer cells for their repair. Some 10% to 20% of breast cancers are ‘triple negative’ (TN) and at least one-third of the tumors in women who have *BRCA1* germline mutations are TN.

### **BRCA1 and BRCA2 Genes**

Family studies of early-onset or premenopausal breast cancer showed that it behaved like a dominant trait in many families. Linkage analysis then mapped a locus to chromosome 17q, eventually leading to identification of the *BRCA1* gene. A proportion of families with early-onset breast cancer that did not show linkage to this region showed linkage to chromosome 13q, resulting in the identification of the *BRCA2* gene.

Mutations in *BRCA1* account for 40% to 50% of familial breast cancer, with gene carriers having a 60% to 85% lifetime risk of developing the disease, as well as a 20% to 60% risk of developing ovarian cancer; and an increased risk of developing prostate cancer in males. Mutations in *BRCA2* account for 30% to 40% of familial breast cancer and the lifetime risks for gene carriers are similar, though the ovarian cancer risk is a little lower. Males have a similar increased risk of prostate cancer. Males with a *BRCA2* mutation also have risk of breast cancer—a lifetime risk of approximately 6%, which is approximately 100 times greater than the population risk for men.

### **Ovarian Cancer**

More than 7000 new diagnoses of ovarian cancer are made annually in the UK, and approximately 1 in 55 women develop the disease, the incidence increasing with age. The majority, approximately 90%, arise as a result of genetic alterations within the ovarian surface epithelium and are therefore referred to as *epithelial* ovarian cancer, which are mostly serous adenocarcinomas (rather than clear cell or mucinous) that are rapidly growing and aggressive. As with other cancers, a multi-step process of genetic change and modification eventually leads to malignancy, though overall it is not well understood.

Approximately 5% of women with ovarian cancer have a family history of the disorder and it is estimated that 10% of all ovarian cancer is strongly predisposed by single-gene mutations, mainly *BRCA1* and *BRCA2*, but less commonly by the genes responsible for Lynch syndrome. The age at presentation is 10 to 15 years earlier when predisposed by germline mutations in these genes. Recently mutations in the *BRIP1* gene (17q32) have been shown to increase the risk of ovarian cancer threefold compared with non-gene carriers, with sufferers being in the older age group and experiencing an aggressive form of disease. The *BRIP1* protein interacts directly with the C-terminal domain of the *BRCA1* protein, but in due course more susceptibility genes will be found. Gene panels available in a service setting currently analyze *TP53*, *PTEN*, *ATM*, *ATR*, and *NF1*, besides the *BRCA* genes.

### **Prostate Cancer**

Prostate cancer is the most common cancer overall after breast cancer, and is the most common cancer affecting men, who have a lifetime risk of 10% of developing the disease and a 3% chance of dying from it. Enquiries into the family history of males presenting with prostate cancer have revealed a significant proportion (approximately 15%) to have a first-degree male relative with prostate cancer. Family studies have shown

that first-degree male relatives of a man presenting with prostate cancer have between two and five times the population risk of developing prostate cancer.

Analysis of prostate cancer tumor material has revealed LOH at several chromosomal locations. Segregation analysis of family studies of prostate cancer suggested that a single dominant susceptibility locus could be responsible, accounting for 9% of all prostate cancers and up to 40% of early-onset prostate cancers (diagnosed before age 55 years). Linkage analysis studies identified two major susceptibility loci, hereditary prostate cancer-1 and -2 (HPC1 and HPC2), and genome wide association studies have highlighted a number of other susceptibility loci of variable significance. It is possible in due course that testing of multiple susceptibility loci will enable identification of high risk individuals who can be offered surveillance. Mutations in the ribonuclease L gene (*RNASEL*) were identified in two families showing linkage to the HPC1 locus at 1q25. Mutations have been found in the *ELAC2* gene at 17p11, the HPC2 locus, and, rarely, mutations in three genes—*PTEN*, *MXII*, and *KAT11*—have been identified in a minority of families with familial prostate cancer. A small proportion of familial prostate cancer is associated with *BRCA1* or *BRCA2*. Men who carry mutations in either *BRCA1* or *BRCA2* have an increased risk, and in one study, conducted in Ashkenazi Jews, men with such mutations had a 16% risk of prostate cancer by age 70 years, compared with 3.8% for the general population.

Although the majority of prostate cancers occur in men older than age 65, individuals with a family history of prostate cancer, consistent with an inherited predisposition, are at increased risk of developing the disease at a relatively younger age (younger than 55 years). Screening by measuring prostate-specific antigen levels and performing digital rectal examination is often offered, but problems with specificity and sensitivity mean that interpretation of results is difficult.

## **Genetic Counseling in Familial Cancer**

Recognition of individuals with an inherited susceptibility to cancer usually relies on taking a careful family history to document the presence or absence of other family members with similar or related cancers. The malignancies that develop in susceptible individuals are often the same as those that occur in the population in general. There are a number of other features that can suggest an inherited cancer susceptibility syndrome in a family (Box 14.1).

### **Inherited Cancer-Predisposing Syndromes**

Although most cancers from an inherited cancer syndrome occur at a specific site, families have been described in which

#### **Box 14.1 Features Suggestive of an Inherited Cancer Susceptibility Syndrome in a Family**

- Several close (first- or second-degree) relatives with a common cancer
- Several close relatives with related cancers (e.g., breast and ovary or bowel and endometrial)
- Two family members with the same rare cancer
- An unusually early age of onset
- Bilateral tumors in paired organs
- Synchronous or successive tumors
- Tumors in two different organ systems in one individual



**FIGURE 14.19** Facial trichodiscomas—the pale, dome-shaped papules found on the head and neck of patients with Birt-Hogg-Dubé syndrome. Affected individuals are at risk of renal cell carcinoma.

cancers occur at more than one site in an individual, or at different sites in various members of the family, more commonly than would be expected. These families are referred to as having a **familial cancer-predisposing** syndrome. The majority of the rare inherited familial cancer-predisposing syndromes currently recognized are dominantly inherited, with offspring of affected individuals having a 50% chance of inheriting the gene and therefore of being at increased risk of developing cancer (see [Table 14.4](#)). For the clinician, awareness of the physical signs that may point to a diagnosis is important, e.g. epidermoid cysts and desmoid disease in FAP, melanin spots around the mouth and lips in Peutz-Jegher syndrome (see [Figure 14.18](#)), macrocephaly, lipomas and the cobblestone tongue in Cowden syndrome ([Figure 14.17](#)), and the dome-shaped skin papules, called trichodiscomas, over the face and neck in Birt-Hogg-Dubé syndrome ([Figure 14.19](#)). In the latter condition pneumothorax may be a presenting feature. The **chromosomal breakage** syndromes ([p. 250](#)), which include ataxia telangiectasia and Bloom syndrome, also predispose to malignancy and mostly follow autosomal recessive inheritance.

These cancer-predisposing syndromes carry a risk of a second primary tumor (multifocal or bilateral in the case of breast cancer), generally present at a relatively young age compared with sporadic forms, and tumors may occur at different sites in the body, though one type of cancer usually predominates.

## Inherited Susceptibility for the Common Cancers

The majority of people with a positive cancer family history do not, in fact, have a cancer-predisposing syndrome. The level of risk for persons with a family history of one of the common cancers, such as bowel or breast cancer, depends on the number of persons with cancer in the family, how closely related the at-risk person is to the affected relative, and the age of onset in affected family member(s). In most instances, where these criteria are not convincingly fulfilled, there is doubt about whether or not a cancer susceptibility gene is responsible. Here one relies on empirical data gained from epidemiological studies to provide risk estimates ([Tables 14.6](#) and [14.7](#)). With respect to mainly breast and ovarian cancers, in recent years the Manchester Scoring System ([Table 14.8](#)) has gained acceptance as a method of determining the likelihood of identifying a *BRCA1* or *BRCA2* mutation based on family history information and tumor markers. The derived score discriminates the likelihood of finding a mutation in one of these genes, which may guide genetic testing—in many centers a threshold of approximately 15% is required.

## Screening for Familial Cancer

Prevention or early detection of cancer is the ultimate goal of screening individuals at risk of familial cancer. The means of prevention for certain cancers can include a change in lifestyle or diet, drug therapy, prophylactic surgery or screening.

Screening of those at risk of familial cancer is usually directed at detecting the phenotypic expression of the genotype (i.e., surveillance for a particular cancer or its precursor). Screening can also include diagnostic tests that indirectly reveal the genotype, looking for other clinical features that are evidence of the presence or absence of the gene. For example, individuals at risk of FAP can be screened for evidence of the *APC* gene by retinal examination, looking for areas of congenital hypertrophy of the retinal pigment epithelium—known as *CHRPEs*. The finding of *CHRPEs* increases the likelihood of

**Table 14.6** Lifetime Risk of Colorectal Cancer for an Individual According to the Family History of Colorectal Cancer\*

Population risk	1 in 50
One first-degree relative affected	1 in 17
One first-degree relative and one second-degree relative affected	1 in 12
One relative younger than age 45 y affected	1 in 10
Two first-degree relatives affected	1 in 6
Three or more first-degree relatives affected	1 in 2

\*Data from Houlston RS, Murday V, Harocopos C, et al. 1990 Screening and genetic counselling for relatives of patients with colorectal cancer in a family screening clinic. *Br Med J* 301:366–368.

**Table 14.7** Lifetime Risk of Breast Cancer in Females According to the Family History of Breast Cancer

Population risk	1 in 10
Sister diagnosed at 65–70 y	1 in 8
Sister diagnosed younger than age 40 y	1 in 4
Two first-degree relatives affected younger than age 40 y	1 in 3

**Table 14.8** The Manchester Scoring System for Predicting the Likelihood that Either a *BRCA1* or *BRCA2* Mutation Will Be Identified, Based on Family History Information

Cancer, and Age at Diagnosis		<i>BRCA1</i>	<i>BRCA2</i>
Female	Male		
Breast <30		6	5
Breast 30–39		4	4
Breast 40–49		3	3
Breast 50–59		2	2
Breast >59		1	1
	Breast <60	5	8
	Breast >59	5	5
Ovarian <60		8	5
Ovarian >59		5	5
	Prostate <60	0	2
	Prostate >59	0	1
Pancreatic		0	1
<i>Tumor Histology and Biomarkers in the INDEX Case</i>		MODIFICATION TO SCORE	FURTHER MODIFICATION
HER2 positive		–4	None
Lobular		–2	Consider ER status
DCIS only		–1	Consider ER status
LCIS		–4	None
Grade 1 IDC		–2	Consider ER status
Grade 2 IDC		0	Consider ER status
Grade 3 IDC		+2	Consider ER status
ER positive		–1	Consider grade
ER negative		+1	Consider grade
Triple negative		+4	None
Ovary: histology other than epithelial / serous		Not included	

In bilateral breast cancer each tumor is counted separately and ductal carcinoma in situ (DCIS) is included.

Example: in the family the proband is a female diagnosed with breast cancer at age 28 (*BRCA1*, 6; *BRCA2*, 5); her mother had breast cancer at age 46 (*BRCA1*, 3; *BRCA2*, 3); a maternal aunt had breast cancer at age 54 (*BRCA1*, 2; *BRCA2*, 2); in addition, a paternal aunt had breast cancer at age 57 (*BRCA1*, 2; *BRCA2*, 2), but this is discounted because this does not provide the highest score in a direct lineage. The total score is therefore 21, which reaches the threshold for testing the *BRCA* genes in most centers.

DCIS, Ductal carcinoma in situ; ER, estrogen receptor; IDC, invasive ductal carcinoma; LCIS, lobular carcinoma in situ.

an individual at risk being heterozygous for the *APC* gene, and therefore developing polyposis and malignancy. CHRPEs are seen in persons with FAP when mutations occur in the first part of the *APC* gene.

Presymptomatic, or predictive, genetic testing for a cancer-predisposing syndrome facilitates targeted surveillance screening—e.g., renal cancer, central nervous system tumors and pheochromocytomas in von Hippel–Lindau disease (Table 14.9). Although the potential for prevention of cancer through screening those at high risk is considerable, it is important to remember that this does little to impact on the overall rate of cancer in the population as these syndromes are relatively rare. Nevertheless, for many familial cancers there are now nationally (and internationally) agreed screening protocols. These must be evidence based and also deliver cost-benefit to the health economy if possible (Box 14.2). In the United Kingdom, screening guidelines produced by the National Institute for Health and Clinical Excellence (NICE) are seen as broadly determining what is available within the NHS, and these are continually evolving.

### Who To Screen?

In the case of the rare familial cancer-predisposing syndromes such as FAP, von Hippel–Lindau, and multiple endocrine neoplasia (MEN), those who should be screened can be identified on a simple Mendelian basis. However, for Rb, for example, the situation is more complex. If no *RBI* mutation has been

identified (if the affected individual is not available or deceased), presymptomatic genetic testing cannot be offered. Some individuals with the non-hereditary form have bilateral tumors, whereas some with the hereditary form have no tumor (i.e., the condition is non-penetrant) or a unilateral tumor. It may be impossible to distinguish which form is present, and screening of second-degree, as well as first-degree, relatives may be appropriate given that early detection can successfully prevent blindness.

### Box 14.2 Requirements of a Screening Test for Persons at Risk for a Familial Cancer-Predisposing Syndrome or at Increased Risk for the Common Cancers

- The test should detect a malignant or premalignant condition at a stage before its producing symptoms, with high sensitivity and specificity
- The treatment of persons detected by screening should improve the prognosis
- The benefit of early detection should outweigh potential harm from the screening test
- The test should preferably be non-invasive as most at-risk individuals require long-term surveillance
- Adequate provision for prescreening counseling and follow-up should be available

**Table 14.9** Suggested Screening Guidelines for Persons at Significant Risk of Cancer: Familial Cancer-Predisposing Syndromes and Common Cancers

Condition/Cancer	Screening Test	Frequency	Starting Age (Y)
<b>Familial Susceptibility for the Common Cancers</b>			
BREAST CANCER			
Breast	Mammography	Annual	40–50 (3 yearly from 50 unless very high risk, e.g., <i>BRCA1</i> or <i>BRCA2</i> gene mutation carrier)
BREAST/OVARY			
Breast	Mammography	Annual	40–50 (as above)
Ovary (not proven)	US/Doppler, CA125	Annual	35
LYNCH SYNDROME (HNPCC)			
Colorectal—high risk families	Colonoscopy	2–3 yearly	25 or 5 y before the earliest diagnosis in the family
Colorectal—intermediate risk families	Colonoscopy	At first consultation or age 35–40 y	Repeat at age 55
Endometrial (not proven)	US	Annual	35–65
Ovary	US	Annual	35
Renal tract	US	Annual	35
Gastric	Gastroscopy	2 yearly	25, if definite Lynch syndrome
Small bowel	None		
Hepatobiliary	None		
Breast	Mammography	Annual	40–50
<b>Familial Cancer—Predisposing Syndromes</b>			
Familial adenomatous polyposis	Retinal examination (CHRPE)*		Childhood
Colorectal	Sigmoid/colonoscopy*†	Annual	12
Duodenal	Gastroscopy	3 yearly	20
Thyroid (women)	None/US?	Annual	20
LI-FRAUMENI			
Breast	MRI	Annual	20–25
Colorectal (suggested)	Colonoscopy	2–3 yearly	25
Sarcoma	None		
Brain	None		
Leukemia	None		
Adrenal cortex	None		
Retinoblastoma	Retinal examination	Frequently	From birth
MULTIPLE ENDOCRINE NEOPLASIA			
Type 1	Ca <sup>2+</sup> , PTH, pituitary hormones, pancreatic hormones	Annual	8 y up to age 50 y
Type 2	Calcitonin provocation test*		10
Medullary thyroid	US	?	10
Pheochromocytoma	Urinary VMA	Annual	10
Parathyroid adenoma	Ca <sup>2+</sup> , PO <sub>4</sub> , PTH	Annual	10
VON HIPPEL-LINDAU			
Retinal angioma	Retinal examination*	Annual	5
Hemangioblastoma	CNS CT/MRI	3 yearly	15 (5 yearly from age 40)
Pheochromocytoma	Urinary VMA	Annual	10
Renal	Abdominal CT	3 yearly	20
	Abdominal US	Annual	20
GORLIN (NEVOID BASAL CELL CARCINOMA) SYNDROME			
BCCs	Clinical surveillance	Annual	10
Medulloblastoma	Clinical surveillance	Annual	Infancy
Odontogenic keratocysts	Orthopantomography	6 monthly	10
COWDEN (PTEN) SYNDROME (SUGGESTED)			
Breast	MRI and mammography	Annual	MRI from 30, mammography from 40
Thyroid	Ultrasound and thyroid function tests	Annual	16
Renal	Ultrasound and urinalysis	Annual	40
Colorectal	Colonoscopy		At 35 and 55 (unless polyps detected)
BIRT-HOGG-DUBÉ SYNDROME (SUGGESTED)			
Renal	MRI	Annual	18
Skin lesions/melanoma	Clinical surveillance		

\*Test to detect heterozygous state.

†In individuals found to be affected, annual colonoscopy prior to colectomy and lifelong 4–6 monthly surveillance of the rectal stump, after subtotal colectomy.

BCC, Basal cell carcinoma; CHRPE, congenital hypertrophy of the retinal pigment epithelium; CT, computed tomography; MRI, magnetic resonance imaging; PTH, parathyroid hormone; US, ultrasonography; VMA, vanillyl mandelic acid.

For those with a family history of the common cancers, such as bowel or breast, the risk levels at which screening is recommended, and below which screening is not likely to be of benefit, will vary. At each extreme of risk the decision is usually straightforward, but with intermediate-level risks there may be doubt as to relative benefits and risks of screening.

### What Age and How Often?

Screening programs must target those at highest risk as well as covering those at moderate risk. In FAP sigmoidoscopy to detect rectal polyps should start in the teenage years, but most cancer screening programs do not start until 25 years of age or later. The highest-risk age band for most inherited susceptibilities is 35 to 50 years, but because cancer can still develop in those at risk at a later age, screening is usually extended. In some families the age of onset of cancer can be especially early and it is recommended that screening of at-risk individuals in these families commences 5 years before the age of onset in the earliest affected member. Childhood cancer risk, such as Rb or Wilms tumor, should obviously be dealt with very differently.

Screening intervals are determined from the natural history of the particular cancer. The development of colorectal cancer from an adenoma is believed to take place over a number of years, and in Lynch syndrome 2–3 yearly screening will usually suffice unless positive findings are made, such as polyps. Breast cancer is not detectable in a premalignant stage and early diagnosis is critical if there is to be a good prognosis. Annual mammography for females at high risk is therefore recommended from the age of 35 years.

### Which Sites to Screen?

In conditions such as Lynch syndrome different sites are at risk of malignancy—mainly colorectal of course but also the endometrium, the ovaries, and others. Principles governing the sensitivity and specificity of screening apply here as elsewhere. Colonoscopy screening meets accepted criteria but there is still no reliable screening modality for either endometrial or ovarian cancer. In some families with Lynch syndrome specific screening of certain sites may be offered if they appear to be an unusually frequent manifestation of the disease, e.g. stomach. A similar, and more dramatic example, is Li-Fraumeni syndrome. Here a wide spectrum of cancers can occur but, apart from regular mammography, no satisfactory screening is available for the other malignancies (see [Table 14.9](#)).

#### Colorectal Cancer

Colorectal carcinoma holds the greatest promise for prevention by screening. Endoscopy provides a sensitive and specific means of examination of the colorectal mucosa and polypectomy can be carried out with relative ease so that screening, diagnosis, and treatment can take place concurrently. Colonoscopy requires a skilled operator because it is an invasive procedure and carries a small but consequent morbidity risk, especially in older people. For Lynch syndrome the screening protocol is well developed (see [Table 14.9](#)) but where this has not been proven the so-called **revised Amsterdam criteria** will help to determine what is offered to those at risk. These minimal criteria suggest a familial form of colonic cancer:

1. At least three relatives (related to each other) affected by a Lynch-related cancer, one a first degree relative of the other two.
2. At least two successive generations affected.

3. Lynch-related cancer diagnosed before age 50 years in at least one relative.

4. FAP excluded

In families fulfilling these criteria there is no debate about the appropriateness of genetic testing to look for a mutation in one of the mismatch repair genes. However, a less obvious clustering of cases in many families should prompt consideration of tumor analysis to look for microsatellite instability (MSI) and IHC. This is often decided on the strength of the **revised Bethesda guidelines**, as follows:

1. Colorectal cancer diagnosed in an individual less than 50 years of age.
2. Presence of synchronous, metachronous colorectal, or other Lynch tumors, regardless of age.
3. Colorectal cancer with MSI-high histology (e.g. tumor infiltrating lymphocytes) diagnosed in a patient less than 60 years of age.
4. Colorectal cancer diagnosed in one or more first-degree relatives with a Lynch-related tumor, with one of the tumors diagnosed at less than 50 years of age.
5. Colorectal cancer diagnosed in two or more first- or second-degree relatives with Lynch-related tumors, at any age.

#### Breast Cancer

In the UK screening of women age 50 years and older for breast cancer by regular mammography has become established as a national program as a result of studies demonstrating improved survival of women detected as having early breast cancer. For women with an increased risk of developing breast cancer because of their family history, there is conflicting evidence of the relative benefit of screening with respect to the frequency of mammography and the chance of developing breast cancer in the interval between the screening procedures (i.e., 'interval' cancer). One reason is that cancer detection rates are lower in premenopausal than in postmenopausal breast tissue.

It is also argued that the radiation exposure associated with annual mammography could be detrimental if started at an early age, leading to an increased risk of breast cancer through screening when carried out over a long period. This is of particular concern in families with Li-Fraumeni syndrome, because mutations in the *TP53* gene have been shown experimentally in vitro to impair the repair of DNA damaged by X-irradiation. However, most experts believe that there is a greater relative benefit than risk in identifying and treating breast cancer in women from this high-risk group.

Mammography is usually offered only to women at increased risk of breast cancer after age 35 years, because interpretation of mammograms is difficult before this age due to the density of the breasts. As a consequence, women at increased risk should be taught breast self-examination and consider clinical examination.

#### Ovarian Cancer

Ovarian cancer in the early stages is frequently asymptomatic and often incurable by the time a woman presents with symptoms. Early diagnosis of ovarian cancer in individuals at high risk is vital, with prophylactic oophorectomy being the only logical, if radical, alternative. The position of the ovaries within the pelvis makes screening difficult. Ultrasonography provides the most sensitive means of screening. Transvaginal scanning is more sensitive than conventional transabdominal scanning, and the use of color Doppler blood flow imaging further enhances

screening of women at increased risk. If a suspicious feature is seen on scanning and confirmed on further investigation, laparoscopy or a laparotomy is usually required to confirm the diagnosis. Screening should be carried out annually as interval cancers can develop if screening is carried out less frequently.

Measuring the levels of CA125, an antigenic determinant of a glycoprotein that is present in increased levels in the blood of women with ovarian cancer, can be also be used as a screening test for women at increased risk of developing ovarian cancer. CA125 levels are not specific to ovarian cancer, as they are also increased in women with a number of other disorders, such as endometriosis. In addition, there are problems with sensitivity (p. 148), because CA125 levels are not necessarily increased in all women with ovarian cancer. Because of the problems outlined with these various screening modalities, many women with an increased risk of developing ovarian cancer choose to have their ovaries removed prophylactically after their family is complete. However, this in turn raises the issue of the benefits and risks associated with taking hormone replacement therapy.

### What Treatment Is Appropriate?

Surgical intervention is the treatment of choice for persons at risk for some of the familial cancer-predisposing syndromes—e.g., prophylactic thyroidectomy in MEN type 2 (especially MEN2B) or colectomy in FAP. For those with a high risk from an inherited susceptibility for one of the common cancers (e.g., colon or breast/ovary), prophylactic surgery is also an accepted option, but the decision is more complex and dependent on the individual patient's choice. The option of prophylactic mastectomy in women at high risk of developing breast cancer is very appealing to some patients but totally abhorrent to others, and alternative management in the form of frequent surveillance, and possibly new drugs showing promise in trials, may be preferred. For patients at high risk of colonic cancer, dietary modification such as the use of non-digestible starch and a daily tablet of aspirin have some benefit (Table 14.10).

Those at an increased risk of developing cancer, especially if it is one of the single-gene dominantly inherited cancer-

predisposing syndromes, or one of the single-gene causes of the common cancers, find themselves in an unenviable situation concerning both their health and the possibility of transmitting the condition to their children. However, there is much hope that the future management and treatment of many forms of cancer will be transformed.

### FURTHER READING

Alexandrov, L.B., Nik-Zainal, S., Wedge, D.C., et al., 2013. Signatures of mutational processes in human cancer. *Nature* 500, 415–421.

*A technical but clear article introducing mutational signatures in cancer genomics.*

Harris, H., Miller, O.J., Klein, G., et al., 1969. Suppression of malignancy by cell fusion. *Nature* 350, 377–378.

*Studies that eventually led to the concept of tumor suppressor genes.*

Helleday, T., Eshtad, S., Nik-Zainal, S., 2014. Mechanisms underlying mutational signatures in human cancers. *Nat. Rev. Genet.* 15, 585–598.

*A technical article explaining the concept of mutational signatures in cancer.*

Hodgson, S.V., Maher, E.R., 2007. A practical guide to human cancer genetics, third ed. Cambridge University Press, Cambridge.

*An up-to-date second edition of this text covering the developing field of human cancer genetics.*

Knudson, A.G., 1971. Mutation and cancer: statistical study of retinoblastoma. *Proc. Natl. Acad. Sci. U.S.A.* 68, 820–823.

*Proposal of the 'two-hit' hypothesis for the development of retinoblastoma.*

Lalloo, F., Kerr, B., Friedman, J., Evans, G., 2005. Risk assessment and management in cancer genetics. Oxford University Press, Oxford.

Li, F.P., Fraumeni, J.F., 1969. Soft tissue sarcomas, breast cancer, and other neoplasms: a familial syndrome? *Ann. Intern. Med.* 71, 747–752.

*The original description of the Li-Fraumeni syndrome.*

Lynch, H.T., 1967. 'Cancer families': adenocarcinomas (endometrial and colon carcinoma) and multiple primary malignant neoplasms. *Recent Results Cancer Res.* 12, 125–142.

*The description of the cancer family syndrome now known as Lynch.*

Murtaza, M., Dawson, S., Tsui, D.W.Y., et al., 2013. Non-invasive analysis of acquired resistance to cancer therapy by sequencing of plasma DNA. *Nature* 497, 108–112.

*A frequently cited paper describing the monitoring of cancer genomics through treatment.*

Stratton, M.R., Campbell, P.J., Futreal, A., 2009. The cancer genome. *Nature* 458, 719–724.

*An important overview of cancer genomics.*

Volgelstein, B., Kinzler, K.W., 2002. The genetic basis of human cancer. McGraw-Hill, London.

*Very comprehensive book covering in detail the cellular biology of cancer and the clinical aspects of the familial cancer-predisposing syndromes and the familial common cancers.*

### Websites

Cancer Research UK:

<https://www.cancerresearchuk.org>.

*Up-to-date on all aspects of cancer and user-friendly.*

My Cancer Genome:

<https://www.mycancergenome.org>.

*US-based, aiming at a personalized approach related to genes and mutations.*

NICE:

<https://www.nice.org.uk/>.

*The UK authority that issues numerous guidelines on drugs and screening.*

COSMIC:

<http://cancer.sanger.ac.uk/cosmic>.

*UK-based at the Sanger Center; a wealth of information about cancer genomics is being assembled here.*

**Table 14.10** Conditions in Which Prophylactic Surgery is an Accepted Treatment, and Treatments that are Under Evaluation, as an Option for the Familial Cancer-Predisposing Syndromes or Individuals at Increased Risk for the Common Cancers

Disorder	Treatment
<b>Accepted Treatment</b>	
Familial adenomatous polyposis	Total colectomy
Ovarian cancer families	Oophorectomy
Breast cancer families	Bilateral mastectomy
MEN2	Total thyroidectomy
<b>Under Evaluation</b>	
Familial adenomatous polyposis	Non-digestible starch—to delay onset of polyposis Aspirin/Sulindac—to reduce rectal and duodenal adenomas
Breast cancer families	Avoidance of oral contraceptives and hormone replacement therapy PARP inhibitors and other novel agents



**ELEMENTS**

- 1** Cancer has both genetic and environmental causes.
- 2** Genetic and environmental factors in the etiology of cancer can be differentiated by epidemiological, family and twin studies, and by analysis of disease, biochemical, and viral associations.
- 3** Studies of tumor viruses have revealed genes present in humans known as oncogenes that are involved in carcinogenesis by altering cellular control mechanisms.
- 4** Study of rare, dominantly inherited tumors in humans, such as retinoblastoma, has led to the identification of tumor suppressor genes, consistent with the hypothesis that the development of cancer involves a minimum of two 'hits'. Persons at risk of familial cancer inherit the first 'hit' in the germ cell, the second 'hit' occurring in somatic cells in mitosis. In persons with sporadically occurring cancer, both 'hits' occur in somatic cells.
- 5** Analysis of DNA tumors by profiling and determination of molecular signatures is beginning to transform our understanding of the genomics and natural history of cancer. Similarly, the ability to detect and analyze circulating tumor DNA is likely to transform the way in which cancer is monitored in the future.
- 6** Some 5% of the common cancers, such as breast and bowel cancer, arise as a result of an inherited cancer susceptibility. Familial susceptibility for cancer can occur as an inherited susceptibility for a single type of cancer or for a number of different types of cancer as part of a familial cancer-predisposing syndrome.
- 7** Persons at risk of an inherited cancer susceptibility can be screened for associated features of a familial cancer predisposing syndrome or for particular cancers.

# Pharmacogenetics, Personalized Medicine and the Treatment of Genetic Disease

*So little done. So much to do.*

ALEXANDER GRAHAM BELL

## Pharmacogenetics

Some individuals can be especially sensitive to the effects of a particular drug, whereas others can be quite resistant. Such individual variation can be the result of factors that are not genetic. For example, both the young and the elderly are very sensitive to morphine and its derivatives, as are people with liver disease. Individual differences in response to drugs in humans are, however, often genetically determined.

The term **pharmacogenetics** was introduced by Vogel in 1959 for the study of genetically determined variations that are revealed solely by the effects of drugs. Pharmacogenetics is now used to describe the influence of genes on the efficacy and side effects of drugs. **Pharmacogenomics** describes the interaction between drugs and the genome (i.e., multiple genes), but the two terms are often used interchangeably. Pharmacogenetics/pharmacogenomics is important because adverse drug reactions are a major cause of morbidity and mortality. The human genome influences the effects of drugs in at least three ways. **Pharmacokinetics** describes the metabolism of drugs, including the uptake of drugs, their conversion to active metabolites, and detoxification or breakdown. **Pharmacodynamics** refers to the interaction between drugs and their molecular targets. An example would be the binding of a drug to its receptor. The third way relates to palliative drugs that do not act directly on the cause of a disease, but rather on its symptoms. Analgesics, for example, do not influence the cause of pain but merely the perception of pain in the brain.

## Drug Metabolism

The metabolism of a drug usually follows a common sequence of events (Figure 15.1). A drug is first absorbed from the gut, passes into the bloodstream, and becomes distributed and partitioned in the various tissues and tissue fluids. Only a small proportion of the total dose of a drug will be responsible for producing a specific pharmacological effect, most of it being broken down or excreted unchanged.

## Biochemical Modification

The actual breakdown process, which usually takes place in the liver, varies with different drugs. Some are oxidized completely

to carbon dioxide, which is exhaled through the lungs. Others are excreted in modified forms either via the kidneys into the urine, or by the liver into the bile and thence the feces. Many drugs undergo biochemical modifications that increase their solubility, resulting in their being more readily excreted.

One important biochemical modification of many drugs is conjugation, which involves union with the carbohydrate glucuronic acid. Glucuronide conjugation occurs primarily in the liver. The elimination of morphine and its derivatives, such as codeine, is dependent almost entirely on this process. Isoniazid, used in the treatment of tuberculosis, and a number of other drugs, including the sulfonamides, are modified by the introduction of an acetyl group into the molecule, a process known as acetylation (Figure 15.2).

## Kinetics of Drug Metabolism

The study of the metabolism and effects of a particular drug usually involves giving a standard dose of the drug and then, after a suitable time interval, determining the response, measuring the amount of the drug circulating in the blood or determining the rate at which it is metabolized. Such studies show that there is considerable variation in the way different individuals respond to certain drugs. This variability in response can be continuous or discontinuous.

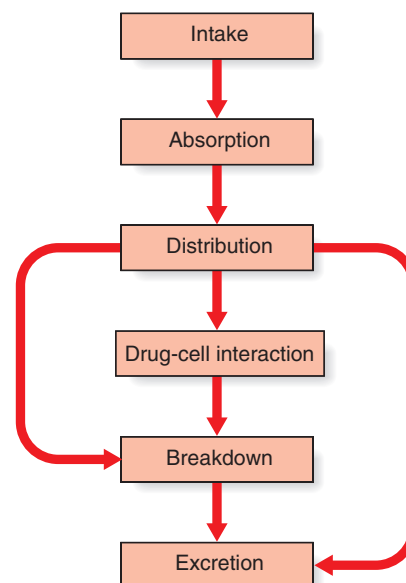


FIGURE 15.1 Stages of metabolism of a drug.

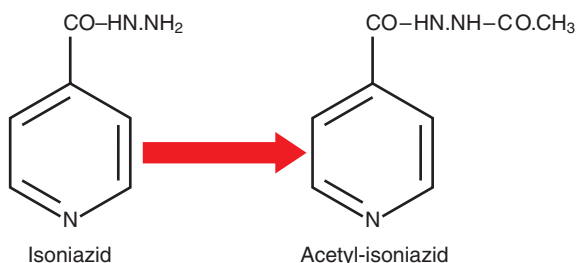


FIGURE 15.2 Acetylation of the antituberculosis drug isoniazid.

If a dose–response test is carried out on a large number of subjects, their results can be plotted. A number of different possible responses can be seen (Figure 15.3). In continuous variation, the results form a bell-shaped or unimodal distribution. With discontinuous variation the curve is bimodal or sometimes even trimodal. A discontinuous response suggests that the metabolism of the drug is under monogenic control. For example, if the normal metabolism of a drug is controlled by a dominant gene,  $R$ , and if some people are unable to metabolize the drug because they are homozygous for a recessive gene,  $r$ , there will be three classes of individual:  $RR$ ,  $Rr$ , and  $rr$ . If the responses of  $RR$  and  $Rr$  are indistinguishable, a bimodal distribution will result. If  $RR$  and  $Rr$  are distinguishable, a trimodal distribution will result, each peak or mode representing a different genotype. A unimodal distribution implies that the metabolism of the drug in question is under the control of many genes—i.e., is polygenic (p. 130).

### Genetic Variations Revealed by the Effects of Drugs

Among the best known examples of drugs that have been responsible for revealing genetic variation in response are isoniazid, primaquine, coumarin anticoagulants, certain anesthetic agents, the thiopurines, and debrisoquine.

#### N-Acetyltransferase Activity

Isoniazid is the first-line medication in prevention and treatment of tuberculosis. It is rapidly absorbed from the gut, resulting in an initial high blood level that is slowly reduced as the drug is inactivated and excreted. The metabolism of isoniazid allows two groups to be distinguished: rapid and slow inactivators. In the former, blood levels of the drug fall rapidly after an oral dose; in the latter, blood levels remain high for some time. Family studies have shown that slow inactivators of isoniazid are homozygous for an autosomal recessive allele of the liver enzyme *N*-acetyltransferase, with lower activity levels. *N*-Acetyltransferase activity varies in different populations. In the United States and Western Europe, approximately 50% of the population are slow inactivators, in contrast to the Japanese, who are predominately rapid inactivators.

In some individuals, isoniazid can cause side effects such as polyneuritis, a systemic lupus erythematosus–like disorder, or liver damage. Blood levels of isoniazid remain higher for longer periods in slow inactivators than in rapid inactivators on equivalent doses. Slow inactivators have a significantly greater risk of developing side effects on doses that rapid inactivators require to ensure adequate blood levels for successful treatment of tuberculosis. Conversely, rapid inactivators have an increased risk of liver damage from isoniazid. Several other drugs are also metabolized by *N*-acetyltransferase, and therefore slow

inactivators of isoniazid are also more likely to exhibit side effects. These drugs include hydralazine, which is an antihypertensive, and sulfasalazine, which is a sulfonamide derivative used to treat Crohn disease.

Studies in other animal species led to the cloning of the genes responsible for *N*-acetyltransferase activity in humans. This has revealed that there are three genes, one of which is not expressed and represents a pseudogene (*NATP*), one that does not exhibit differences in activity between individuals (*NAT1*), and a third (*NAT2*), mutations in which are responsible for the inherited polymorphic variation. These inherited variations in *NAT2* have been reported to modify the risk of developing a number of cancers, including bladder, colorectal, breast, and lung cancer. This is thought to be through differences in acetylation of aromatic and heterocyclic amine carcinogens.

#### Glucose 6-Phosphate Dehydrogenase Variants

For many years, quinine was the drug of choice in the treatment of malaria. Although it has been very effective in acute attacks, it is not effective in preventing relapses. In 1926 primaquine was introduced and proved to be much better than quinine in preventing relapses. However, it was not long after primaquine was introduced that some people were found to be sensitive to the drug. The drug could be taken for a few days with no apparent ill effects, and then suddenly some individuals would begin to pass very dark, often black, urine. Jaundice developed and the red cell count and hemoglobin concentration gradually fell as a consequence of hemolysis of the red

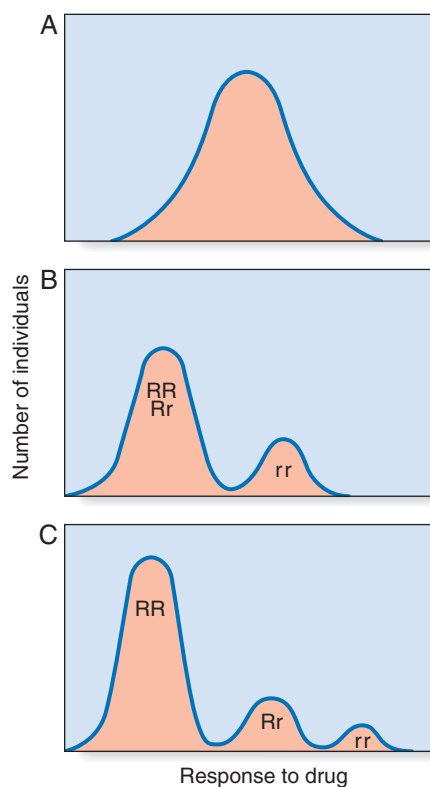


FIGURE 15.3 Various types of response to different drugs consistent with polygenic and monogenic control of drug metabolism. **A**, Continuous variation, multifactorial control of drug metabolism. **B**, Discontinuous bimodal variation. **C**, Discontinuous trimodal variation.

blood cells. Affected individuals usually recovered from such a hemolytic episode, but occasionally the destruction of the red cells was extensive enough to be fatal. The cause of such cases of primaquine sensitivity was subsequently shown to be a deficiency in the red cell enzyme glucose 6-phosphate dehydrogenase (G6PD).

G6PD deficiency is inherited as an X-linked recessive trait (p. 71), rare in Caucasians but affecting approximately 10% of Afro-Caribbean males and relatively common in the Mediterranean. It is thought to be relatively common in these populations as a result of conferring increased resistance to the malarial parasite. These individuals are sensitive not only to primaquine, but also to many other compounds, including phenacetin, nitrofurantoin, and certain sulfonamides. G6PD deficiency is thought to be the first recognized pharmacogenetic disorder, having been described by Pythagoras around 500 BC.

### Coumarin Metabolism by CYP2C9

Coumarin anticoagulant drugs, such as warfarin, are used in the treatment of a number of different disorders to prevent the blood from clotting (e.g., after a deep venous thrombosis). Warfarin is metabolized by the cytochrome P450 enzyme encoded by the CYP2C9 gene, and two variants (CYP2C9\*2 and CYP2C9\*3) result in decreased metabolism. Consequently, these patients require a lower warfarin dose to maintain their target international normalized ratio range and may be at increased risk of bleeding.

### Debrisoquine Metabolism by CYP2D6

Debrisoquine is a drug that was used frequently in the past for the treatment of hypertension. There is a bimodal distribution in the response to the drug in the general population. Approximately 5% to 10% of persons of European origin are poor metabolizers, being homozygotes for an autosomal recessive gene with reduced hydroxylation activity.

Molecular studies revealed that the gene involved in debrisoquine metabolism is one of the P450 family of genes on chromosome 22, known as CYP2D6. The mutations responsible for the poor metabolizer phenotype are heterogeneous; 18 different variants have been described.

CYP2D6 variation is important because this enzyme is involved in the metabolism of more than 20% of prescribed drugs, including the  $\beta$ -blockers metoprolol and carvedilol, the antidepressants fluoxetine and imipramine, the antipsychotics thioridazine and haloperidol, the painkiller codeine, and the anti-cancer drug tamoxifen.

### Malignant Hyperthermia

Malignant hyperthermia (MH) is a rare complication of anesthesia. Susceptible individuals develop muscle rigidity as well as an increased temperature (hyperthermia), often as high as 42.3°C (108°F) during anesthesia. This usually occurs when halothane is used as the anesthetic agent, particularly when succinylcholine is used as the muscle relaxant for intubation. If it is not recognized rapidly and treated with vigorous cooling, the affected individual will die.

MH susceptibility is inherited as an autosomal dominant trait affecting approximately 1 in 10,000 people. The most reliable prediction of an individual's susceptibility status requires a muscle biopsy with in vitro muscle contracture testing in response to exposure to halothane and caffeine.

MH is genetically heterogeneous, but the most common cause is a mutation in the ryanodine receptor (*RYR1*) gene.

Variants in other genes may influence susceptibility within individual families and explain the discordant results of the in vitro contracture test and genotype in members of some families that segregate *RYR1* mutations.

### Thiopurine Methyltransferase

A group of potentially toxic substances known as the thiopurines, which include 6-mercaptopurine, 6-thioguanine, and azathioprine, are used extensively in the treatment of leukemia to suppress the immune response in patients with autoimmune disorders such as systemic lupus erythematosus and to prevent rejection of organ transplants. They are effective drugs clinically but have serious side effects, such as leukopenia and severe liver damage. Azathioprine is reported to cause toxicity in 10% to 15% of patients and it is possible to predict those patients susceptible to side effects by measuring biochemical activity levels or analyzing genetic variation within the thiopurine methyltransferase (*TPMT*) gene. This gene encodes an enzyme responsible for methylation of thiopurines, and approximately two-thirds of patients who experience toxicity have one or more variant alleles.

### Dihydropyrimidine Dehydrogenase

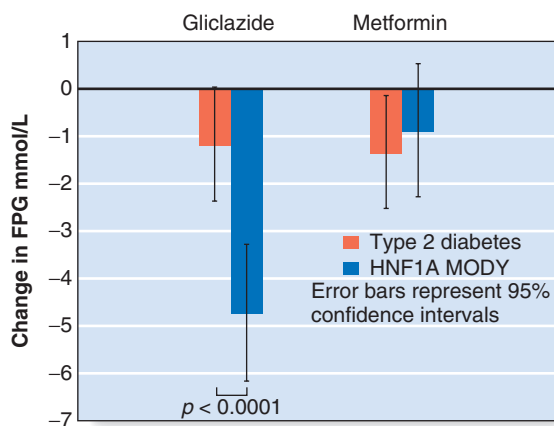
Dihydropyrimidine dehydrogenase (DPYD) is the initial and rate-limiting enzyme in the catabolism of the chemotherapeutic drug 5-fluorouracil (5FU). Deficiency of DPYD is recognized as an important pharmacogenetic factor in the etiology of severe 5FU-associated toxicity. Measurement of DPYD activity in peripheral blood mononuclear cells or genetic testing for the most common *DPYD* gene mutation (a splice site mutation, IVS14 + 1G > A, which results in the deletion of exon 14) may be warranted in cancer patients before the administration of 5FU.

## Personalized Medicine

Using genetic or genomic information to select the most appropriate choice of pharmacological therapy at the correct dosage is a step towards **personalized** or **individualized medicine**. During the past 10 years many examples of **stratified medicine** have emerged, where the treatment for a particular disease is dependent on the genetic subtype of the patient. These examples include monogenic subtypes of rare diseases where a different treatment is recommended for patients with mutations in a specific gene, or stratification at the level of a tumor type, based on its genetic characteristics. In other disorders, the treatment may depend on the subtype of mutation, for example the new drugs developed to treat cystic fibrosis (CF) according to the mutation effect. A genetic (or genomic) diagnosis is therefore an essential step towards the most appropriate treatment. Current initiatives are focused on improving health outcomes through **precision medicine**. This is an integrated, multi-disciplinary, multi-level approach that analyzes human samples and healthcare data to improve clinical care through increased precision in the understanding of mechanisms of both disease and drug response.

### Maturity-Onset Diabetes of the Young

Maturity-onset diabetes of the young (MODY) is a monogenic form of diabetes characterized by young age of onset (often before the age of 25 years), dominant inheritance and beta cell dysfunction. Many patients are misdiagnosed with type 1 diabetes and treated with insulin. The clinical observation of



**FIGURE 15.4** Response to the sulphonylurea gliclazide and the type 2 diabetes drug metformin in patients with *HNF1A* maturity-onset diabetes of the young (MODY) and type 2 diabetes. Patients ( $n = 18$  in each group) were treated with each drug for 6 weeks in a randomized trial. FPG, Fasting plasma glucose. (Modified from Pearson ER, Starkey BJ, Powell RJ, et al 2003 Genetic cause of hyperglycemia and response to treatment in diabetes. *Lancet* 362:1275–1281.)

sensitivity to sulphonylurea treatment in a patient with an *HNF1A* mutation causing MODY led to a randomized cross-over trial that showed a fourfold increased response to sulphonylureas in patients with *HNF1A* mutations compared with a control group with type 2 diabetes (Figure 15.4). For many patients a genetic diagnosis of *HNF1A* MODY means that they can transfer from insulin injections to sulphonylurea tablets.

### Neonatal Diabetes

The most frequent cause of permanent neonatal diabetes is an activating mutation in the *KCNJ11* or *ABCC8* genes, which encode the Kir6.2 and SUR1 subunits of the ATP-sensitive potassium (K-ATP) channel in the pancreatic beta cell. The effect of such mutations is to prevent K-ATP channel closure by reducing the response to ATP. Because channel closure is the trigger for insulin secretion, these mutations result in diabetes, and a requirement for lifelong insulin treatment. Defining the genetic etiology for this rare subtype of diabetes has led to improved treatment, because most patients can be treated successfully with sulphonylurea tablets instead of insulin. These drugs bind to the sulphonylurea receptor subunits of the K-ATP channel to cause closure independently of ATP, thereby triggering insulin secretion (Figure 15.5). High-dose sulphonylurea therapy results in improved glycemic control which will reduce the risk of diabetic complications in later life. Some patients have a more severe mutation that also affects the K-ATP channel function in the brain. Transfer from insulin to sulphonylureas can improve their motor and cognitive function, as well as control of their diabetes. International guidelines now recommend genetic testing for anyone diagnosed with diabetes in the first 6 months of life in order to identify those patients who will benefit from sulphonylurea treatment.

### Pharmacogenomics

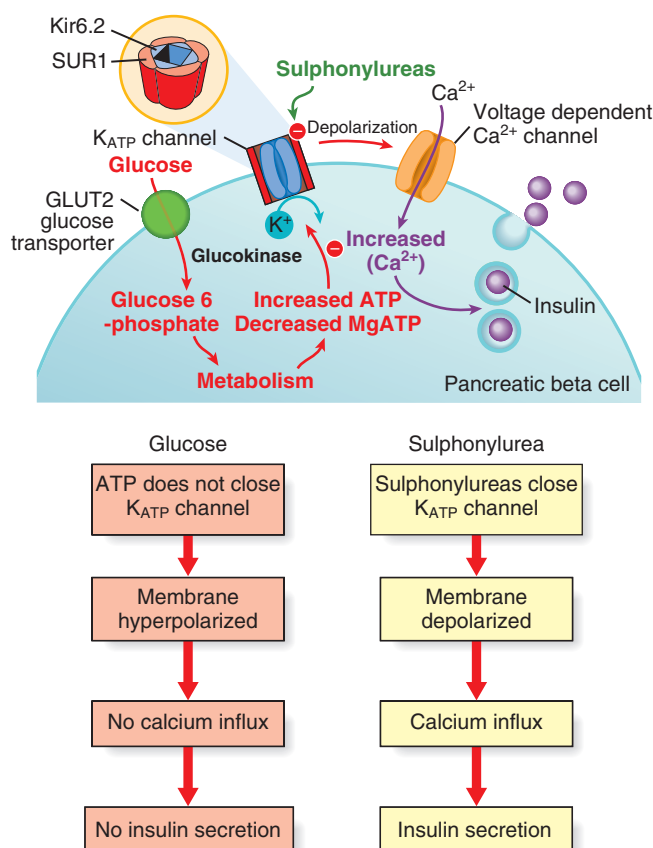
Pharmacogenomics is defined as the study of the interaction of an individual's genetic makeup and response to a drug. The key distinction between pharmacogenetics and pharmacogenomics is that the former describes the study of variability in drug

responses attributed to individual genes and the latter describes the study of the entire genome related to drug response. The expectation is that inherited variation at the DNA level results in functional variation in the gene products that play an essential role in determining the variability in responses, both therapeutic and adverse, to a drug. If polymorphic DNA sequence variation occurs in the coding portion or regulatory regions of genes, it is likely to result in variation in the gene product through alteration of function, activity, or level of expression. Automated analysis of genome-wide single nucleotide polymorphisms (SNPs) (p. 50) allows the possibility of identifying genes involved in drug metabolism, transport and receptors that are likely to play a role in determining the variability in efficacy, side effects, and toxicity of a drug.

The possibility of utilizing genome sequencing as a routine clinical diagnostic test (p. 63) opens up the possibility of creating an individual's own pharmacogenomics profile to provide information about optimal drug dosage or likelihood of adverse events.

### Adverse Events

It is estimated that approximately 15% of hospital inpatients will be affected by an adverse drug reaction. The objective of adverse-event pharmacogenetics is to identify a genetic profile



**FIGURE 15.5** Insulin secretion in the pancreatic beta cell. Activating mutations in the genes encoding the K-ATP channel subunits Kir6.2 and SUR1 prevent closure of the channel in the presence of glucose. Sulphonylureas bind to the SUR1 subunit to close the channel and restore insulin secretion. (Courtesy Professor A. T. Hattersley, University of Exeter Medical School, Exeter, UK.)

that characterizes patients who are more likely to suffer such an adverse event. The best known example is abacavir, a reverse transcriptase inhibitor used to treat human immunodeficiency virus (HIV) infection. Approximately 5% of patients show potentially fatal hypersensitivity to abacavir and this limits its use. A strong association with the human leukocyte antigen allele B\*5701 was proven in 2002. Today testing for B\*5701 is routine practice before abacavir is prescribed.

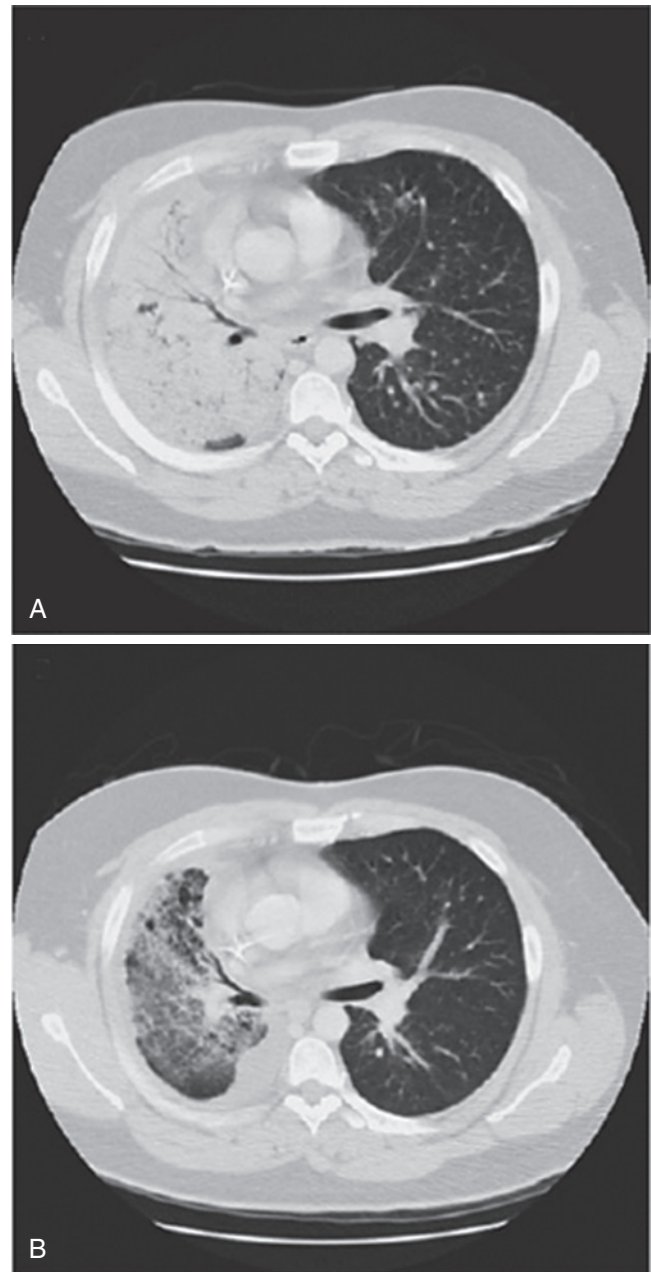
At least 10% of Africans, North Americans, and Europeans are homozygous for a variant in the promoter of the *UGT1A1* gene (*UGT1A1*\*28) resulting in reduced glucuronidation of irinotecan, a drug used to treat colorectal cancer, and increases the risk of severe neutropenia if exposed to the standard dose. A simple polymerase chain reaction–based test for *UGT1A1*\*28 can be used to determine the appropriate treatment dose.

### Efficacy

There is no doubt that the cost-effectiveness of drugs is improved if they are prescribed only to those patients likely to respond to them. Several drugs developed for the treatment of various cancers have different efficacy depending on the molecular biology of the tumor (see [Table 15.1](#)). For example, trastuzumab is an antibody that targets overexpression of *HER2/neu* protein observed in approximately one-third of patients with breast cancer. Consequently, patients are prescribed herceptin only if their tumor has been shown to overexpress *HER2/neu*.

Imatinib is a protein tyrosine kinase inhibitor that has been used to treat chronic myeloid leukemia since 2001. It is a very effective treatment that works by binding the BCR-ABL fusion protein resulting from the t(9;22) translocation. This is an example of effective drug design resulting from knowledge of the molecular etiology. More recently it has been also shown to be effective in the treatment of gastrointestinal stromal tumors that harbor *KIT* mutations.

Approximately 13% of patients with non–small cell lung cancer have an activating *EGFR* mutation. These mutations increase the activity of the epidermal growth factor receptor tyrosine kinase domain so that the receptor is constitutively active in the absence of epidermal growth factor. This leads to increased proliferation, angiogenesis and metastasis. Drugs designed to block the *EGFR* tyrosine kinase domain and inhibit these effects have been developed. Patients with lung tumors harboring an activating *EGFR* mutation can show a dramatic response to treatment with these drugs (gefitinib and erlotinib) as shown in [Figure 15.6](#). Similarly, melanomas with activating *BRAF* mutations respond to the *BRAF* kinase inhibitor,



**FIGURE 15.6** Example of the response to gefitinib in a patient with non–small cell lung cancer and an activating *EGFR* mutation. A computed tomographic scan of the chest shows a large mass in the right lung before treatment (**A**) and marked improvement 6 weeks after gefitinib was initiated (**B**). (Reproduced with permission from Lynch TJ, Bell DW, Sordella R, et al 2004 Activating mutations in the epidermal growth factor receptor underlying responsiveness of non–small cell lung cancer to gefitinib. *N Engl J Med* 350:2129–2139.)

**Table 15.1** Examples of Drugs Effective for the Treatment of Specific Cancers

Type of Cancer	Characteristic	Drug
Breast	<i>HER2</i> overexpression	Trastuzumab
Chronic myeloid leukemia	t(9;22) BCR-ABL fusion	Imatinib
Non–small cell lung cancer	<i>EGFR</i> activating mutation	Gefitinib or erlotinib
Gastrointestinal stromal tumor	<i>KIT</i> or <i>PDGFRA</i> activating mutation	Imatinib
Malignant melanoma	<i>BRAF</i> activating mutation	Vemurafenib

vemurafenib, and targeted therapies are being developed for many other tumor types.

### Treatment of Genetic Disease

Many genetic disorders are characterized by progressive disability or chronic ill health for which there is, at present, no effective treatment. Consequently, one of the most exciting aspects of the developments in biotechnology is the prospect of new treatments mediated through gene transfer, RNA

modification, or stem cell therapy. It is important, however, to keep a perspective on the limitations of these approaches for the immediate future and to consider, in the first instance, conventional approaches to the treatment of genetic disease.

### Conventional Approaches to Treatment of Genetic Disease

Most genetic disorders cannot be cured or even ameliorated using conventional methods of treatment. There are still disorders where the underlying genetic cause has not been identified so that there is little, if any, understanding of the basic metabolic or molecular defect. If, however, the genetic basis is known then dietary restriction, as in phenylketonuria (p. 255), or hormone replacement, as in congenital adrenal hyperplasia (p. 261), can be used very successfully in the treatment of the disorder. In a few disorders, such as homocystinuria (p. 258) and some of the organic acidurias (p. 258), supplementation with a vitamin or co-enzyme can increase the activity of the defective enzyme with beneficial effect (Table 15.2).

### Protein/Enzyme Replacement

If a genetic disorder is found to be the result of a deficiency of or an abnormality in a specific enzyme or protein, treatment could, in theory, involve replacement of the deficient or defective enzyme or protein. An obviously successful example of this is the use of factor VIII concentrate in the treatment of hemophilia A (p. 300).

For most of the inborn errors of metabolism in which an enzyme deficiency has been identified, recombinant DNA techniques may be used to biosynthesize the missing or defective gene product; however, injection of the enzyme or protein may not be successful if the metabolic processes involved are carried out within cells and the protein or enzyme is not normally transported into the cell. Modifications in  $\beta$ -glucocerebrosidase as used in the treatment of Gaucher disease enable it to enter the lysosomes, resulting in an effective form of treatment (p. 265). Another example is the modification of adenosine deaminase (ADA) by an inert polymer, polyethylene glycol, to generate a replacement enzyme that is less immunogenic and has an extended half-life.

### Drug Treatment

In some genetic disorders, drug therapy is possible; for example, statins can help to lower cholesterol levels in familial hypercholesterolemia (p. 262). Statins function indirectly through the low-density lipoprotein (LDL) receptor by inhibiting endogenous cholesterol biosynthesis at the rate-limiting step that is mediated by hydroxymethyl glutaryl co-enzyme A (HMG-CoA) reductase. This leads to upregulation of the LDL receptor and increased LDL clearance from plasma.

Recent years have seen the successful **repurposing** of drugs including sulfonylureas and rapamycin. The hypoglycemic effect of sulfonylureas was discovered in 1942 and these drugs have been used in tablet form to treat type 2 diabetes for nearly 70 years. Sulfonylureas work by binding to the ATP-sensitive potassium ( $K_{ATP}$ ) channels of the beta cell to depolarize the membrane and allow insulin release. When mutations in the genes encoding the  $K_{ATP}$  channel subunits were discovered to be the most common cause of neonatal diabetes it was possible to very quickly transfer these patients from insulin injections to sulfonylurea tablets and achieve better glycemic control. This was only possible because the rigorous safety testing required for new pharmaceutical products had been completed

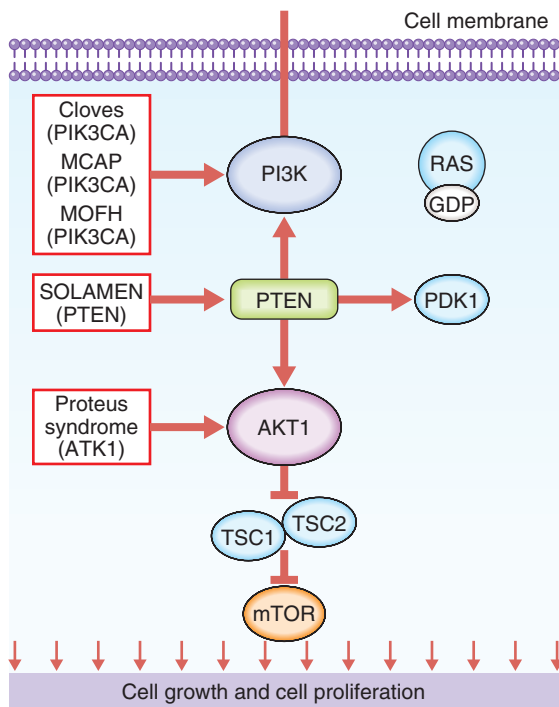
**Table 15.2** Examples of Various Methods for Treating Genetic Disease

Treatment	Disorder
<b>Enzyme Induction by Drugs</b>	
Phenobarbitone	Congenital non-hemolytic jaundice
<b>Replacement of Deficient Enzyme/Protein</b>	
Blood transfusion	Thalassemia
Bone marrow transplantation	SCID resulting from adenosine deaminase deficiency
<b>Enzyme/Protein Preparations</b>	
Trypsin	Trypsinogen deficiency
$\alpha_1$ -Antitrypsin	$\alpha_1$ -Antitrypsin deficiency
Cryoprecipitate/factor VIII	Hemophilia A
$\beta$ -Glucosidase	Gaucher disease
$\alpha$ -Galactosidase	Fabry disease
<b>Replacement of Deficient Vitamin or Coenzyme</b>	
B <sub>6</sub>	Homocystinuria
B <sub>12</sub>	Methylmalonic acidemia
Biotin	Propionic acidemia
D	Vitamin D-resistant rickets
<b>Replacement of Deficient Product</b>	
Cortisone	Congenital adrenal hyperplasia
Thyroxine	Congenital hypothyroidism
<b>Substrate Restriction in Diet</b>	
AMINO ACIDS	
Phenylalanine	Phenylketonuria
Leucine, isoleucine, valine	Maple syrup urine disease
CARBOHYDRATE	
Galactose	Galactosemia
LIPID	
Cholesterol	Familial hypercholesterolemia
Protein	Urea cycle disorders
<b>Drug Therapy</b>	
Aminocaproic acid	Angioneurotic edema
Dantrolene	Malignant hyperthermia
Cholestyramine	Familial hypercholesterolemia
Pancreatic enzymes	Cystic fibrosis
Penicillamine	Wilson disease, cystinuria
<b>Drug/Dietary Avoidance</b>	
Sulfonamides	G6PD deficiency
Barbiturates	Porphyria
<b>Replacement of Diseased Tissue</b>	
Kidney transplantation	Adult-onset polycystic kidney disease, Fabry disease
Bone marrow transplantation	X-linked SCID, Wiskott-Aldrich syndrome
<b>Removal of Diseased Tissue</b>	
Colectomy	Familial adenomatous polyposis
Splenectomy	Hereditary spherocytosis

SCID, Severe combined immunodeficiency.

many decades earlier and use in many thousands of patients had not revealed any safety issues.

Rapamycin was first discovered in 1975 in a soil sample on Easter Island (the island is also known as Rapa Nui, hence the name rapamycin). It is a macrolide, produced by the microorganism *Streptomyces hygroscopicus* and showed antifungal properties. Shortly after its discovery, immunosuppressive properties were detected, which later led to the establishment of rapamycin as an immunosuppressant. In the 1980s, it was also found to have anticancer activity although the exact mechanism of action remained unknown until the 1990s when



**FIGURE 15.7** The PI3K/AKT/mTOR pathway is an intracellular signaling pathway important in regulating the cell cycle. PI3K activation phosphorylates and activates AKT, localizing it in the plasma membrane. There are many known factors that enhance the PI3K/AKT pathway including EGF, IGF-1, and insulin. The pathway is antagonized by various factors including PTEN. (Reproduced with permission from Eichenfield LF, Frieden IJ 2014 *Neonatal and Infant Dermatology* 3 ed. Elsevier.)

it was shown to inhibit cellular proliferation and cell cycle progression via the PI3K/AKT/mTOR pathway (Figure 15.7). Rapamycin (sirolimus) has recently been used to treat congenital hyperinsulinism as an alternative to sub-total pancreatectomy, and the rapamycin derivative everolimus is used in patients with tuberous sclerosis who have subependymal giant cell astrocytomas.

Drug therapy might also be directed at a subset of patients according to their molecular defect. An example is the development of premature termination codon (PTC) therapy (ataluren) for patients with nonsense mutations causing CF or Duchenne muscular dystrophy. Ataluren interacts with the ribosome to enable read-through of premature stop codons to produce full-length functional protein. It is now licensed in Europe for the treatment of Duchenne muscular dystrophy in boys aged 5 years and above. An alternative approach for treating Duchenne muscular dystrophy is to upregulate the dystrophin homolog, utrophin. Immune rejection is not a problem and oral administration of the compound SMT022357 leads to increased utrophin expression in skeletal, respiratory and cardiac muscles in the *mdx* mouse.

The cloning of the *CFTR* gene in 1989 gave great hope of a cure for CF through gene therapy. It was thought likely to be amenable to gene therapy as the level of functional protein sufficient to produce a clinical response might be as low as 5% to 10% and the lung is a relatively accessible tissue. However, progress to date has been slow and, although gene therapy can potentially correct the primary and secondary defects associated with CF, the extent and duration of gene expression has

been inadequate, owing to the rapid turnover of lung epithelial cells.

The biggest breakthrough in the treatment of CF has come from the development of drugs designed to improve the function of the CFTR protein. The first drug, ivacaftor, is a CFTR potentiator that improves the transport of chloride ions through the ion channel by increasing the open probability of the channel. It was approved originally for the 4% of CF patients who have the p.Gly551Asp (G551D) mutation, but is now also available for patients with nine other mutations that reduce channel activity. A second drug, lumacaftor, was developed to treat patients with the most common *CFTR* mutation, p.Phe508del. This mutation causes mis-folding of the protein and consequently the protein does not reach the cell surface. Lumacaftor is designed to improve the folding of the protein in order that more protein reaches the cell surface. In 2015, combination therapy of ivacaftor with lumacaftor was shown to improve lung function for patients who are homozygous for the p.Phe508del *CFTR* mutation. These drugs were developed by Vertex pharmaceuticals in conjunction with the Cystic Fibrosis Foundation. They are expensive, with annual costs for ivacaftor of over \$200,000.

### Tissue Transplantation

Replacement of diseased tissue has been a further option since the advent of tissue typing (p. 170). An example is renal transplantation in adult polycystic kidney disease or lung transplantation in patients with CF.

Islet transplantation for treating type 1 diabetes mellitus was transformed in 2000 with development of the 'Edmonton' protocol. Islet cells are prepared from donated pancreases (usually two per patient) and injected into the liver of the recipient: at 3 years post-transplant more than 80% of patients are still producing their own insulin.

### Therapeutic Applications of Recombinant DNA Technology

The advent of recombinant DNA technology led to rapid progress in the availability of biosynthetic gene products. Insulin used in the treatment of diabetes mellitus was previously obtained from pig pancreases. This had to be purified for use very carefully, and even then it occasionally produced sensitivity reactions in patients. The introduction of recombinant DNA technology enabled microorganisms to be used for the synthesis of large quantities of insulin from the human insulin gene. Recombinant DNA technology is employed in the production of a number of other biosynthetic products (Table 15.3). The

**Table 15.3** Proteins Produced Biosynthetically Using Recombinant DNA Technology

Protein	Disease
Insulin	Diabetes mellitus
Growth hormone	Short stature resulting from growth hormone deficiency
Factor VIII	Hemophilia A
Factor IX	Hemophilia B
Erythropoietin	Anemia
$\alpha$ -Galactosidase A	Fabry disease (X-linked lysosomal storage disorder)
$\beta$ -Interferon	Multiple sclerosis



biosynthesis of medically important peptides in this way is usually more expensive than obtaining the product from conventional sources because of the research and development involved. For example, the cost of treating one patient with Gaucher disease can exceed \$150,000 per year. However, biosynthetically derived products have the dual advantages of providing a pure product that is unlikely to induce a sensitivity reaction and one that is free of the risk of chemical or biological contamination. In the past, the use of growth hormone from human cadaver pituitaries has been associated with the transmission of Creutzfeldt-Jakob disease, and HIV has been a contaminant in cryoprecipitate containing factor VIII used in the treatment of hemophilia A (p. 300).

## Gene Therapy

Gene therapy is the therapeutic delivery of nucleic acid polymers into a patient's cells as a drug to treat disease. It is defined by the UK Gene Therapy Advisory Committee (GTAC) as 'the deliberate introduction of genetic material into human somatic cells for therapeutic, prophylactic, or diagnostic purposes'. Gene therapy includes techniques for delivering synthetic or recombinant nucleic acids into humans; genetically modified biological vectors (such as viruses or plasmids), genetically modified stem cells, oncolytic viruses, nucleic acids associated with delivery vehicles, naked nucleic acids, antisense techniques (e.g., gene silencing, gene correction, or gene modification), genetic vaccines, DNA or RNA technologies such as RNA interference, and xenotransplantation of animal cells (but not solid organs).

Advances in molecular biology leading to the identification of many human disease genes and their protein products have raised the prospect of gene therapy for many monogenic (and non-genetic) disorders. The first human gene therapy trial began in 1990, but it is important to emphasize that, although it was heralded as the new panacea in medicine, progress has been slow and there are still many practical difficulties to overcome before gene therapy can deliver its full potential. Disorders that are possible candidates for gene therapy include both genetic and non-genetic diseases (Table 15.4).

## Regulatory Requirements

There has been much publicity about the potential uses and abuses of gene therapy. Regulatory bodies have been established in several countries to oversee the technical, therapeutic, and safety aspects of gene therapy programs (p. 207). There is universal agreement that **germline gene therapy**, in which genetic changes could be distributed to both somatic and germ cells, and thereby be transmitted to future generations, is morally and ethically unacceptable. Therefore programs are focusing only on **somatic cell gene therapy**, in which the alteration in genetic information is targeted to specific cells, tissues, or organs in which the disorder is manifest.

In the United States, the Human Gene Therapy Subcommittee of the National Institutes of Health has produced guidelines for protocols of trials of gene therapy that must be submitted for approval to both the Food and Drug Administration and the Recombinant DNA Advisory Committee, along with their institutional review boards. In the United Kingdom, the GTAC provides ethical oversight of proposals to conduct clinical trials involving gene or stem cell therapies in humans, taking account of the scientific merits, and the potential benefits and risks.

**Table 15.4** Diseases That Can Potentially Be Treated by Gene Therapy

Disorder	Defect
Immune deficiency	Adenosine deaminase deficiency Purine nucleoside phosphorylase deficiency Chronic granulomatous disease
Hypercholesterolemia	Low-density lipoprotein receptor abnormalities
Hemophilia	Factor VIII deficiency (A) Factor IX deficiency (B)
Gaucher disease	Glucocerebrosidase deficiency
Mucopolysaccharidosis VII	$\beta$ -Glucuronidase deficiency
Emphysema	$\alpha_1$ -Antitrypsin deficiency
Cystic fibrosis	<i>CFTR</i> mutations
Phenylketonuria	Phenylalanine hydroxylase deficiency
Hyperammonemia	Ornithine transcarbamylase deficiency
Citrullinemia	Argininosuccinate synthetase deficiency
Muscular dystrophy	Dystrophin mutations
Spinal muscular atrophy	<i>SMN1</i> gene deletion
Thalassemia/sickle cell anemia	$\alpha$ - and $\beta$ -globin mutations
Malignant melanoma	
Ovarian cancer	
Brain tumors	
Neuroblastoma	
Renal cancer	
Lung cancer	
AIDS	
Cardiovascular diseases	
Rheumatoid arthritis	

More than 2200 clinical trials of gene therapy have been approved for children and adults for a variety of genetic and non-genetic disorders. Serious adverse events are rare, but the death in 1999 of a patient in a trial for ornithine transcarbamylase deficiency highlighted the risks of gene therapy and led to tighter regulation. There have also been three cases of leukemia in children, one of whom died, after receiving gene therapy for X-linked severe combined immunodeficiency (X-SCID) (p. 173).

## Technical Aspects

Prerequisites include that the genetic basis and pathophysiology of the disorder must be known and the specific cells, tissue, or organ affected by the disease process must be accessible. The means by which the functional gene is introduced must be both efficient and safe. If gene therapy is to be considered as a realistic alternative to conventional treatments, there should be unequivocal evidence from trials of gene therapy carried out in animal models that the inserted gene functions adequately with appropriate regulatory, promoter, and enhancer sequences. In addition, it needs to be shown that the treated tissue or cell population has a reasonable lifespan, that the gene product continues to be expressed, and that the body does not react adversely to the gene product, for instance by producing antibodies to the protein product. Last, it is essential to demonstrate that introduction of the gene or DNA sequence has no deleterious effects, such as inadvertently leading to a

malignancy or a mutagenic effect on either the somatic or the germ-cell lines, for example through mistakes arising as a result of the insertion of the gene or DNA sequence into the host DNA, or what is known as **insertional mutagenesis**. In two patients who developed leukemia after gene therapy for XL-SCID, the retrovirus used to deliver the  $\gamma$ -c (*IL2RG*) gene was shown to have inserted into the *LMO-2* oncogene, which plays a role in some forms of childhood leukemia, on chromosome 11.

### Gene Transfer

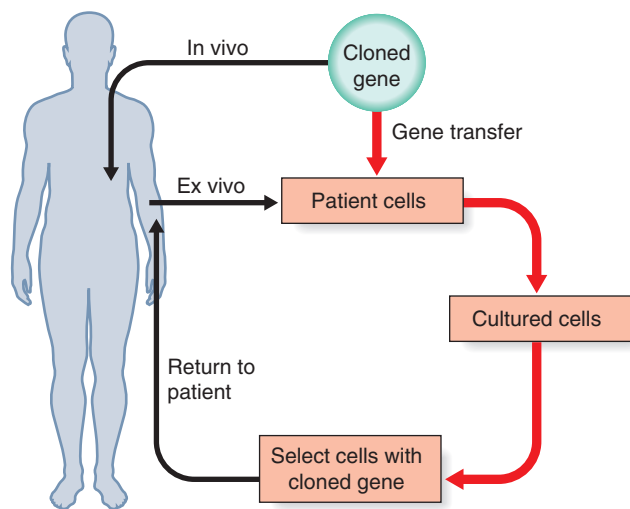
Gene transfer can be carried out either *ex vivo* by treatment of cells or tissue from an affected individual in culture, with reintroduction into the affected individual, or *in vivo* if cells cannot be cultured or be replaced in the affected individual (Figure 15.8). The *ex vivo* approach is limited to disorders in which the relevant cell population can be removed from the affected individual, modified genetically, and then replaced. The *in vivo* approach is the most direct strategy for gene transfer and can theoretically be used to treat many hereditary disorders.

### Target Organs

Gene therapy is usually directed or limited to a particular organ, tissue or body system.

#### Liver

Liver cells are susceptible to transfection by retroviruses *in vitro*. Cells removed from the liver by partial hepatectomy can be treated *in vitro* and then re-injected via the portal venous system, from which they seed in the liver. Hypercholesterolemia is a major cause of cardiovascular disease in the Western world. The most severe form, autosomal recessive familial hypercholesterolemia, is caused by homozygous or compound heterozygous mutations in the LDL receptor (LDLR) gene. Patients are likely to require maintenance therapy with invasive



**FIGURE 15.8** In vivo and ex vivo gene therapy. In vivo gene therapy delivers genetically modified cells directly to the patient. An example is *CFTR* gene therapy using liposomes or adenovirus via nasal sprays. Ex vivo gene therapy removes cells from the patient, modifies them *in vitro* and then returns them to the patient. An example is the treatment of fibroblasts from patients with hemophilia B by the addition of the factor IX gene. Modified fibroblasts are then injected into the stomach cavity.

LDL apheresis, and often die of myocardial infarction in their third decade of life. Gene therapy for lipid disorders has a high potential for success, but studies to date based on viral-mediated overexpression of LDLR cDNA have been unsuccessful, probably because vectors have lacked the sterol response elements that are required for regulated transcription.

### Central Nervous System

Gene therapy for central nervous system disorders, such as Parkinson and Alzheimer diseases, requires delivery to the brain. Lentiviral vectors are particularly suitable because they integrate into the host genome of non-dividing cells and can potentially act as a delivery system for stable expression. Early clinical trials involving lentiviral delivery of three genes that encode enzymes that produce dopamine have yielded encouraging results. The first patients with advanced Parkinson disease had this surgery 4 years ago and have improved movement and better quality of life, and positron emission tomography scanning confirmed dopamine production in the brain.

### Muscle

Unlike other tissues, direct injection of foreign DNA into muscle has met with success in terms of retention and expression of the foreign gene in the treated muscle. In 2012, the European Medicines Agency approved the first gene therapy treatment in either Europe or the United States. Alipogene tiparvovec is designed to restore lipoprotein lipase activity to clear fat-carrying chylomicron particles formed in the intestine after a fat-containing meal. It contains the human *LPL* gene packaged with a tissue-specific promoter in a non-replicating adeno-associated virus vector. A naturally occurring variant of the gene is used that confers higher activity and is administered in a series of up to 60 intramuscular injections.

### Bone Marrow

One of the first diseases for which gene therapy was attempted in humans is the inherited severe combined immunodeficiency disorder (SCID) caused by ADA deficiency (p. 173). The most successful conventional treatment for ADA deficiency is bone marrow transplantation from a matched sibling donor. The alternative is a twice weekly injection of the necessary enzyme, a life-long process that is very expensive and does not achieve optimal immune sufficiency.

A 4-year-old girl with ADA deficiency was the first patient ever to undergo gene therapy. The trial involved removal of white blood cells and correction with the *ADA* gene *ex vivo* before the cells were re-injected. This showed benefit, but the effect was temporary. In trials since 2009, patients have undergone autologous stem cell transplants with bone marrow cells corrected *ex vivo* using viral vectors. All 18 children have developed their own new, fully functioning immune system and are now cured.

This approach has also been used in four patients with beta thalassemia who have undergone *ex vivo* correction of their hematopoietic stem cells with a lentiviral vector containing the *HBB* gene and have not required blood transfusions since.

### Eye

Leber congenital amaurosis is an autosomal recessive disorder caused by mutations in the *RPE65* gene and characterized by poor vision at birth with complete loss of vision in early adulthood. Early studies in a naturally occurring dog model (the

Briard dog) showed that gene therapy by means of a single operation involving sub-retinal injection of an adeno-associated vector carrying the full length *RPE65* gene sequence was both safe and effective. Clinical trials in 2008 showed sustained improvement in 12 patients (aged 8 to 44 years) after treatment with an adeno-associated viral (AAV) vector containing the *RPE65* gene injected into the retinal pigment cells.

The most recent success is in treating choroidemia, caused by defects in the *CHM* gene. Lack of the REP-1 protein encoded by this gene means that cells in the retina stop working and slowly begin to die, causing blindness. Injection of an AAV vector carrying the *CHM* gene into the retina of six patients has shown improved vision. There is much excitement regarding the potential benefits for younger children whose loss of vision is not so far advanced. One obvious advantage for measuring the success of gene therapy in this condition is that a single eye can be treated whilst the other eye serves as a control. This research provides proof of principle that genetic forms of blindness may be reversed.

There are two main methods for delivering gene transfer, viral and non-viral.

### Viral Agents

A number of different viruses can be used to transport foreign genetic material into cells and the most successful viral agents are described in the following sections.

#### Lentiviruses

The lentivirus family includes HIV. Lentiviruses are complex viruses that infect macrophages and lymphocytes, but their main advantage is that they can be integrated into non-dividing cells. They may, therefore, be useful in the treatment of neurological conditions.

#### Adenoviruses

Adenoviruses can be used as vectors in gene therapy as they infect a wide variety of cell types. They are stable, can infect non-dividing cells and carry up to 36 kb of foreign DNA. In addition, they are suitable for targeted treatment of specific tissues such as the respiratory tract, and have been extensively used in gene therapy trials for the treatment of CF.

Adenoviruses do not integrate into the host genome, thereby avoiding the possibility of insertional mutagenesis but having

the disadvantage that expression of the introduced gene is usually unstable and often transient. They also contain genes known to be involved in the process of malignant transformation, so there is a potential risk that they could inadvertently induce malignancy. By virtue of their infectivity, they can produce adverse effects secondary to infection and by stimulating the host immune response. This was demonstrated by a vector-related death following intravascular administration of high doses ( $3.8 \times 10^{13}$ ) of adenovirus particles to a patient with ornithine transcarbamylase deficiency.

#### Adeno-Associated Viruses

Adeno-associated viruses are non-pathogenic parvoviruses in humans that require co-infection with helper adenoviruses or certain members of the herpes virus family to achieve infection. In the absence of the helper virus, the adeno-associated virus DNA integrates into chromosomal DNA at a specific site on the long arm of chromosome 19 (19q13.3-qter). Subsequent infection with an adenovirus activates the integrated adeno-associated viral DNA-producing virions. They have the advantages of being able to infect a wide variety of cell types, exhibiting long-term gene expression and not generating an immune response to transduced cells. The safety of adeno-associated viruses as vectors occurs by virtue of their site-specific integration but, unfortunately, this is often impaired with the inclusion of foreign DNA in the virus. The disadvantages of adeno-associated viruses include the fact that they can be activated by any adenovirus infection and that, although 95% of the vector genome is removed, they can take inserts of foreign DNA of only up to 5 kb in size.

#### Non-Viral Methods

There are a number of different non-viral methods of gene therapy but the most popular is liposome-mediated DNA transfer. This has the theoretical advantage of not eliciting an immune response, being safer and simpler to use as well as allowing large-scale production, but efficacy is limited.

#### Liposomes

Liposomes are lipid bilayers surrounding an aqueous vesicle that can facilitate the introduction of foreign DNA into a target cell (Figure 15.9). A disadvantage of liposomes is that they are not very efficient in gene transfer and the expression of the

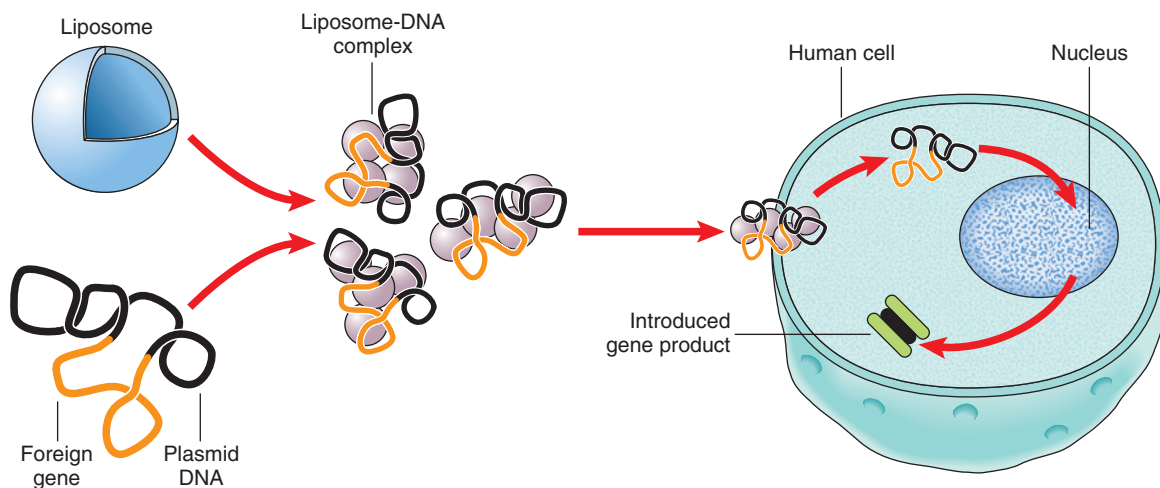


FIGURE 15.9 Diagrammatic representation of liposome-mediated gene therapy.

foreign gene is transient, so that the treatment has to be repeated. An advantage of liposome-mediated gene transfer is that a much larger DNA sequence can be introduced into the target cells or tissues than with viral vector systems.

## RNA Modification

RNA modification therapy targets mRNA, either by suppressing mRNA levels or by correcting/adding function to the mRNA.

### Antisense Oligonucleotides

Antisense therapy may be used to modulate the expression of genes associated with monogenic disorders. The principle of antisense technology is the sequence-specific binding of an antisense oligonucleotide (typically 18 to 30 bases in length) to a target mRNA that results in inhibition of gene expression at the protein level.

Antisense oligonucleotides can be used to force exon skipping and convert out-of-frame deletions that cause DMD to in-frame deletions usually associated with the milder Becker muscular dystrophy phenotype. This approach could be successful for up to 70% of patients with DMD. The first clinical trial involved four patients who underwent intramuscular injection of an antisense oligonucleotide to target exon 51. Dystrophin was restored in the vast majority of muscle fibers at levels between 17% and 35%, without any adverse effects. However, the results from a phase III trial in 2013 were disappointing. Whilst the boys who received 48 weeks' treatment with the antisense drug, drisapersen, were able to walk approximately 10 meters further than those who received the placebo, this difference was not statistically significant.

One key hurdle in the use of antisense oligonucleotide therapy is the fact that each different antisense is considered a new drug and requires separate regulatory approval. This makes their development more expensive and not feasible for low prevalence mutations for which there would be insufficient patients for clinical trials. The potential for antisense therapy is perhaps greater in spinal muscular atrophy (p. 277) where the non-expressed *SMN2* gene could be converted to generate functional *SMN1* protein in virtually all patients. A phase 3 trial has shown extended survival in infants and the company producing the antisense therapy predicts that it will be used in clinical practice within several years. It is hoped that this antisense approach will find future success in the treatment of patients with Huntington disease by silencing of the expanded repeat allele.

### RNA Interference

This technique also has broad therapeutic application, as any gene may be a potential target for silencing by RNA interference. In contrast to antisense oligonucleotide therapy where the target mRNA is bound, as a result of RNA interference the target mRNA is cleaved and it is estimated to be up to 1000-fold more active. RNA interference works through the targeted degradation of mRNAs containing homologous sequences to synthetic double-stranded RNA molecules known as small interfering RNAs (siRNAs) (Figure 15.10). The siRNAs may be delivered in drug form using strategies developed to stabilize antisense oligonucleotides, or from plasmids or viral vectors. The furthest developed compound is ALN-TTR02 (also known as patisiran), which targets TTR amyloid deposits. These are the cause of familial amyloidotic polyneuropathy in patients with

TTR mutations. A phase I study showed approximately 85% knockdown of serum TTR protein and neurological disease stabilized or even improved over 6 months. A Phase III clinical trial was initiated in 2013 and is due for completion in 2017.

## Targeted Gene Correction

A promising new approach is to repair genes *in situ* through the cellular DNA repair machinery (p. 22). Proof of principle has been demonstrated in an animal model of Pompe disease. The point mutation was targeted by chimeric double-stranded DNA-RNA oligonucleotides containing the correct nucleotide sequence. Repair was demonstrated at the DNA level and normal enzyme activity was restored.

The latest strategy uses engineered zinc-finger nucleases (ZFNs) to stimulate homologous recombination. Targeted cleavage of DNA is achieved by zinc-finger proteins designed to recognize unique chromosomal sites and fused to the non-specific DNA cleavage domain of a restriction enzyme. A double-strand break induced by the resulting ZFNs can create specific changes in the genome by stimulating homology-directed DNA repair between the locus of interest and an extrachromosomal molecule. A recent report describes ZFN-driven gene correction in bone marrow stem cells from patients with sickle cell disease that resulted in the production of wild-type hemoglobin tetramers.

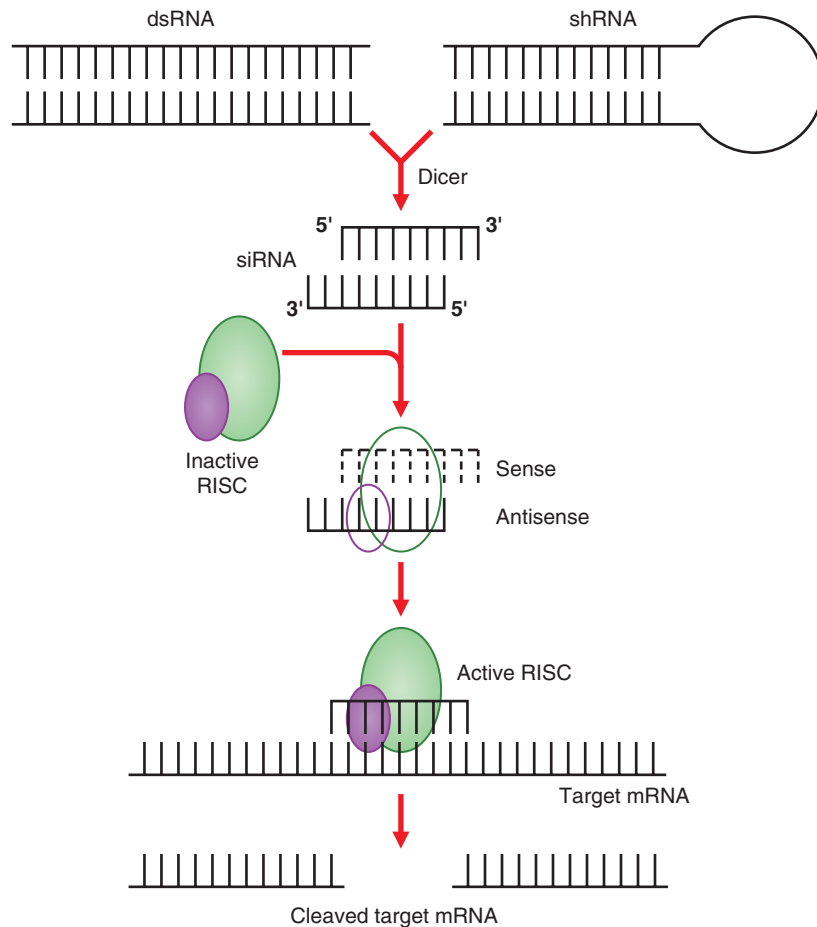
In the future, the new CRISPR/Cas9 technology (p. 45) offers great potential for genome editing to treat genetic disease. Early approaches will harvest patient hematopoietic stem cells and correct the genetic defect *ex vivo* before returning the cells to the patient's bone marrow.

## Stem Cell Therapy

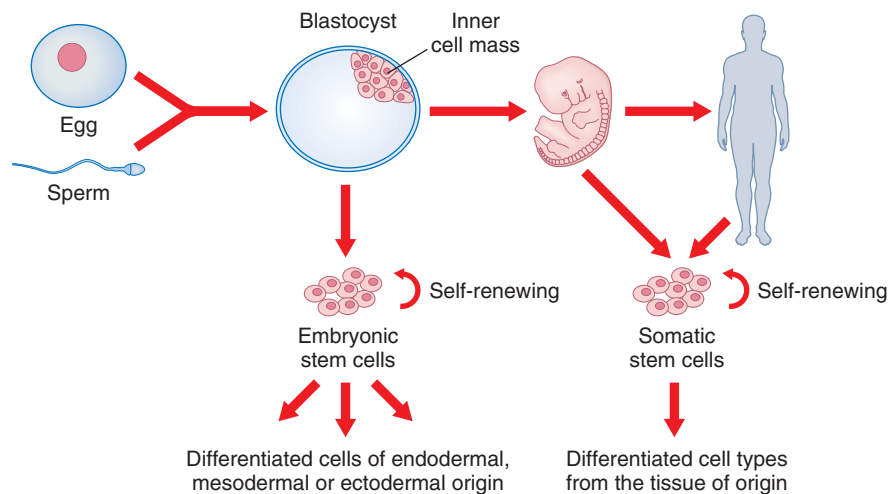
Stem cells are unspecialized cells that are defined by their capacity for self-renewal and the ability to differentiate into specialized cells along many lineages. Embryonic stem cells are pluripotent, which means they can give rise to derivatives of all three germ layers (i.e., all cell types that are found in the adult organism). Somatic stem cells can only differentiate into the cell types found in the tissue from which they are derived (Figure 15.11), but can be isolated from any human, whatever their age. Nowadays the term **induced pluripotent stem cell (iPS)** is used rather than **somatic** or **adult stem cell**.

Bone-marrow transplantation is a form of somatic stem cell therapy that has been used for more than 40 years. During the past 5 years, cord blood stem cells have emerged as an alternative source. Although these transplants can be an effective treatment for a number of genetic disorders, including ADA deficiency, SCID, X-linked adrenoleukodystrophy, lysosomal storage diseases, and Fanconi anemia, the associated risks of infection due to immunosuppression and graft-versus-host disease are high. The main limitation is the lack of a suitable bone-marrow donor or availability of matched cord blood stem cells.

Transplantation of stem cells (e.g., pluripotent hematopoietic stem cells) *in utero* offers the prospect of a novel mode of treatment for genetic disorders with a congenital onset. The immaturity of the fetal immune system means that the fetus will be tolerant of foreign cells so that there is no need to match the donor cells with those of the fetus. A small number of trials have been performed but engraftment has so far only been successful in cases of SCID.



**FIGURE 15.10** Mechanism of RNA interference. Double-stranded (ds) RNAs are processed by Dicer, in an ATP-dependent process, to produce small interfering RNAs (siRNA) of about 21–23 nucleotides in length with two-nucleotide overhangs at each end. Short hairpin (sh) RNAs, either produced endogenously or expressed from viral vectors, are also processed by Dicer into siRNA. An ATP-dependent helicase is required to unwind the dsRNA, allowing one strand to bind to the RNA-induced silencing complex (RISC). Binding of the antisense RNA strand activates the RISC to cleave mRNAs containing a homologous sequence. (From Lieberman J, Song E, Lee SK, Shankar P 2003 *Interfering with disease: opportunities and roadblocks to harnessing RNA interference*. *Trends Mol Med* 9:397–403, with permission.)



**FIGURE 15.11** Generation of embryonic and somatic stem cells. The fusion of the sperm and egg during fertilization establishes a diploid zygote that divides to create the blastocyst. Embryonic stem cells (ESCs) are derived from the inner cell mass of the blastocyst. ESCs in culture are capable of self-renewal without differentiation and are able to differentiate into all cell types of the endoderm, mesoderm, and ectoderm lineages using appropriate signals. Somatic stem cells are also capable of self-renewal and, with appropriate signals, differentiate into various cell types from the tissue from which they are derived.

## Embryonic Stem Cell Therapy

Teratomas (benign) and teratocarcinomas (malignant) are tumors that are found most commonly in the gonads. Their name is derived from the Greek word 'teras' (monster); it describes their appearance well, as these tumors contain teeth, pieces of bone, muscles, skin, and hair. A key experiment demonstrated that if a single cell is removed from one of these tumors and injected intraperitoneally, it acts as a stem cell by producing all the cell types found in a teratocarcinoma.

Mouse embryonic stem cells were first isolated and cultured 30 years ago. Studies of human embryonic stem cells have lagged behind, but the pace of research increased exponentially following the achievement in 1998 of the first cultured human embryonic stem cells.

## Embryonic Stem Cells for Transplantation

The ability of an embryonic stem cell (ESC) to differentiate into any type of cell means that the potential applications of ESC therapy are vast. One approach involves the differentiation of ESCs in vitro to provide specialized cells for transplantation. For example, it is possible to culture mouse ESCs to generate dopamine-producing neurons. When these neural cells were transplanted into a mouse model for Parkinson disease, the dopamine-producing neurons showed long-term survival and ultimately corrected the phenotype. This 'therapeutic cloning' strategy has been proposed as a future therapy for other brain disorders such as stroke and neurodegenerative diseases. However, after many encouraging small studies of fetal cell transplantation for Parkinson disease, three randomized, double-blind, placebo-controlled studies found no net benefit. Also, patients in two of the studies developed dyskinesias that persisted despite reductions in medication. Further

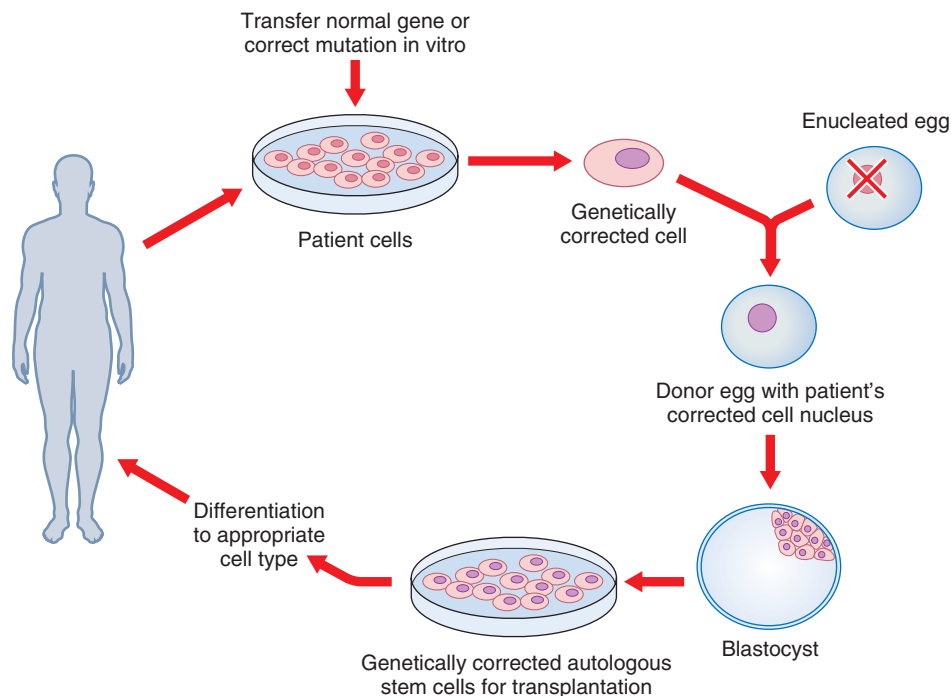
research is needed to understand and overcome the dual problems of unpredictable benefit and troublesome dyskinesias after dopaminergic cell transplantation. In addition, post mortem analysis of patients who received fetal brain cell transplantation revealed that implanted cells are prone to degeneration just like endogenous neurons in the same pathological area, indicating that long-term efficacy of cell therapy of Parkinson disease needs to overcome the degenerating environment in the brain.

## Gene Therapy Using Embryonic Stem Cells

An alternate strategy is to use ESCs as delivery vehicles for genes that mediate phenotype correction through gene-transfer technology. One potential barrier to using human ESCs to treat genetic disorders is immunorejection of the transplanted cells by the host. This obstacle might be overcome by using gene transfer with the relevant normal gene to autologous cells (such as cultured skin fibroblasts), transfer of the corrected nucleus to an enucleated egg from an unrelated donor, development of 'corrected' ESCs and, finally, differentiation and transplantation of the corrected relevant cells to the same patient (Figure 15.12).

A crucial component of future clinical applications of this strategy is the ability to derive 'personalized' human ESC lines using the nuclear transfer technique. Although research on this technology has been controversial, the efficient transfer of somatic cell nuclei to enucleated oocytes from unrelated donors, and the subsequent derivation of human ESC lines from the resulting blastocysts, is a technical hurdle that has recently been overcome.

There has been much debate around the ethical issues of using ESCs and it seems that embryonic stem cells may not be



**FIGURE 15.12** Embryonic stem cells for gene therapy. The strategy depicted starts with removing cells (e.g., fibroblasts) from a patient with a monogenic disorder and then transferring the normal gene using a vector (or perhaps by correcting the mutation in vitro). The nucleus from a corrected cell is then transferred to an enucleated egg obtained from an unrelated donor by somatic cell nuclear transfer. The egg, now containing the genetically corrected genome of the patient, is activated to develop into a blastocyst in vitro, and corrected autologous stem cells are derived from the inner cell mass. The stem cells are then directed to differentiate into a specific cell type and transferred to the patient, thereby correcting the disorder.

an essential prerequisite, as iPS cells have been found in many more tissues than was once thought possible. Hence iPS cells might be used for transplantation.

### Induced Pluripotent Stem Cell Therapy

Certain kinds of somatic stem cell seem to have the ability to differentiate into a number of different cell types, given the right conditions. Recent progress in stem cell biology has shown that iPS-derived cells can be used to successfully treat rodent Parkinson disease models, thus solving the problem of immunorejection and paving the way for future autologous transplantations for treating this disease and others.

### Mesenchymal Stem Cells

Mesenchymal stem cell (MSC) therapy, through its promise of repair and regeneration of cardiac tissue, represents an exciting avenue of treatment for a range of cardiovascular diseases. Cardiovascular disease is the leading cause of death in developed countries. Although cardiomyocytes retain limited plasticity following maturation, the heart is grossly unable to recover from structural damage.

MSCs are relatively immuno-privileged, lacking both major histocompatibility II and T cell co-stimulatory signal expression, and possess the unique ability to home into sites of myocardial damage when delivered systemically. They are obtained either from the bone marrow of healthy adult volunteers or from the patients themselves, and cultured in vitro with appropriate factors before being delivered to the damaged heart. Animal studies have shown therapeutic benefit via several distinct mechanisms, the most important of which appears to be the abundant secretion of paracrine factors that promote local regeneration. Phase I clinical trials have shown that this approach is safe and the results of phase II trials are eagerly awaited to see if there will be clear clinical benefit.

The genetic disorder retinitis pigmentosa (p. 271) results in the loss of photoreceptors, leading to visual symptoms in the teens and blindness by 40 to 50 years of age. Systemic administration of pluripotent bone marrow-derived MSCs in a rat model has demonstrated improved visual function and trials are in progress to test this approach in humans. This is a potentially exciting development for the future treatment of other forms of retinal degeneration and other ocular vascular diseases such as diabetic retinopathy.

A third application of MSC therapy is in bone repair and metabolic bone diseases such as osteogenesis imperfecta (p. 76) and hypophosphatasia, because MSCs can also differentiate to form bone and cartilage.

### Limbal Stem Cells

The corneal limbus harbors corneal epithelial stem cells known as **limbal stem cells (LSCs)**. Corneal conditions, such as infections, tumors, immunological disorders, trauma, and chemical burns, often lead to the deficiency of the corneal stem cells, and subsequent vision loss. Treatment of limbal stem cell

deficiency (LSCD) has been achieved in eight patients who had complete LSCD in one eye. A small sample of the limbal epithelium of the patient's healthy eye was removed and grown in cell culture using the patient's own serum and donated amniotic cells to provide the required conditioning medium. Twelve days later, the LSCs were transplanted onto the patients' unhealthy eye and the group was followed for around 18 months. Overall, all patients had a decrease in pain and an increase in visual acuity.

Stem cell therapy has now progressed from preclinical (animal studies) to clinical trials for a variety of disorders. In general, these studies have shown enormous potential in the animal models but more limited success in humans so far. Aside from participation in regulated trials, patients should be advised that stem cell therapy is at an early stage and discouraged from undergoing forms of treatment whose safety and efficacy is not yet proven. An unwanted spin-off from stem cell research has been the development of so called stem cell tourism. Patients have travelled to countries where stem cell-based treatment is not regulated to receive expensive treatments that are scientifically unproven. These treatments are at best, ineffective and at worst, dangerous.

### FURTHER READING

- Aartsma-Rus, A., van Ommen, G.-J.B., 2010. Progress in therapeutic antisense applications for neuromuscular disease. *Eur. J. Hum. Genet.* 18, 146–153.
- A review of antisense oligonucleotide therapy for Duchenne muscular dystrophy, spinal muscular atrophy, and myotonic dystrophy.*
- Belmonte, J.C.I., Ellis, J., Hochedlinger, K., Yamanaka, S., 2009. Induced pluripotent stem cells and reprogramming: seeing the science through the hype. *Nat. Rev. Genet.* 10, 878–883.
- An overview of the advantages and disadvantages of embryonic stem cell vs induced pluripotent stem cell therapy.*
- Brown, B.D., Naldini, L., 2009. Exploiting and antagonizing microRNA regulation for therapeutic and experimental applications. *Nat. Rev. Genet.* 10, 578–585.
- Article describing the potential applications of RNA interference.*
- Goldstein, D.B., Tate, S.K., Sisodiya, S.M., 2003. Pharmacogenetics goes genomic. *Nat. Rev. Genet.* 4, 937–947.
- Review of pharmacogenetics/genomics.*
- Newman, W., Payne, K., 2008. Removing barriers to a clinical pharmacogenetics service. *Personalized Med.* 5, 471–480.
- A review article describing the application of pharmacogenetics to current clinical practice.*
- Pearson, E.R., Flechtner, I., Njolstad, P.R., et al., 2006. Switching from insulin to oral sulfonylureas in patients with diabetes due to Kir6.2 mutations. Neonatal Diabetes International Collaborative Group. *N. Engl. J. Med.* 355, 467–477.
- Pharmacogenetic treatment of monogenic diabetes.*
- Pennisi, E., 2013. The CRISPR craze. *Science* 341, 833–836.
- The discovery and promise of CRISPR technology.*
- Yamanaka, S., 2012. Induced pluripotent stem cells: Past, present and future. *Cell Stem Cell* 10, 678–684.
- The fascinating history and future of stem cell research with insights into the future applications of induced pluripotent stem cells.*

## ELEMENTS

- 1 Pharmacogenomics is defined as the study of the interaction of an individual's genetic makeup and response to a drug. The key distinction between pharmacogenetics and pharmacogenomics is that the former describes the study of variability in drug responses attributed to individual genes and the latter describes the study of the entire genome related to drug response.
- 2 Knowledge regarding the genetic etiology and pathophysiology of the disease process can lead to stratified treatments. Examples of so-called personalized or precision medicine include sulfonylurea therapy for certain monogenic subtypes of diabetes, ivacaftor and lumacaftor for cystic fibrosis, trastuzumab for breast cancers showing *HER2* overexpression, imatinib for chronic myeloid leukemia and gefitinib for non-small cell lung cancers with activating *EGFR* mutations. Testing for B\*5701 status before prescribing abacavir is now routine for patients with HIV infection to reduce the risk of potentially fatal hypersensitivity.
- 3 Gene therapy is the therapeutic delivery of genetic material into a patient's cells as a drug to treat disease. It requires that the gene involved must be characterized, the particular cell type or tissue to be targeted must be identified, an efficient, reliable, and safe vector system that results in stable continued expression of the introduced gene has to be developed, and the safety and effectiveness of the particular modality of gene therapy has to be demonstrated. Some success has been achieved by delivering a functional copy of the relevant gene, or through modifying gene expression through antisense therapy, but gene therapy is not yet widely available.
- 4 Germline gene therapy is universally viewed as ethically unacceptable, whereas somatic cell gene therapy is generally viewed as being acceptable, because this is seen as similar to existing treatments such as organ transplantation.
- 5 Embryonic or induced pluripotent stem cells might be used therapeutically in a regenerative approach in which they are differentiated in vitro to specialized cell types (or progenitors of the target specialized cells), and then transplanted in vivo to replace diseased cells or tissues. Alternatively they could be used as delivery vehicles for gene-transfer technology.



# Congenital Abnormalities, Dysmorphic Syndromes, and Learning Disability

The formation of a human being, a process sometimes known as **morphogenesis**, involves extremely complicated cell biology that, though still not fully understood, has begun to yield its mysteries (see [Chapter 9](#)). Given the complexity, it is not surprising that on occasion it goes wrong. Nor is it surprising that in many congenital abnormalities genetic factors can clearly be implicated. More than 5000 dysmorphic, multiple congenital anomaly, and mental retardation syndromes are described in the London Dysmorphology Database, covering single gene disorders, sporadic and non-genetic conditions, as well those caused by teratogenic agents. For most of those due to single gene mutations or variants the cause is now known and next generation sequencing technology has the power to uncover the underlying reason in many of the rest. We cannot do justice to this vast field in a limited space, and many examples feature elsewhere (e.g., [Chapters 9, 17](#)), but in this chapter we consider the overall impact of abnormalities in morphogenesis by reviewing the following:

1. The incidence of abnormalities at various stages from conception onwards.
2. Their nature and the ways in which they can be classified.
3. Their causes, when known, with particular emphasis on the role of genetics.

## Incidence

### Spontaneous First-Trimester Pregnancy Loss

It has been estimated that approximately 50% of all human conceptions are lost either before implantation at 5 to 6 days postconception or shortly afterwards (i.e., before the woman realizes she is pregnant). Among recognized pregnancies, at least 15% end in spontaneous miscarriage before 12 weeks' gestation. Even when material from the abortus can be obtained, it is often very difficult to establish why a pregnancy loss has occurred. However, careful study of large numbers of spontaneously aborted embryos has shown that gross structural abnormalities are present in 80% to 85%. These abnormalities vary from complete absence of an embryo in the developing pregnancy sac—a **blighted ovum**—to a very distorted body shape, or a specific abnormality in a single body system.

Chromosome abnormalities such as trisomy, monosomy, or triploidy are found in approximately 50% of all spontaneous abortions. This incidence rises to 60% when a gross structural abnormality is present and it is very likely that submicroscopic

*They certainly give very strange names to diseases.*

PLATO

or de novo single-gene abnormalities account for a proportion of the remainder.

### Congenital Abnormalities and Perinatal Mortality

Perinatal mortality figures include all infants who are stillborn after 28 weeks' gestation plus deaths during the first week of life. Of all perinatal deaths, 25% to 30% occur as a result of a serious structural abnormality and in 80% of these cases genetic factors can be implicated. The *relative* contribution of structural abnormalities to perinatal mortality is lower in developing countries, where environmental factors and health care provision play a much greater role.

### Newborn Infants

Surveys reviewing the incidence of both major and minor anomalies in newborn infants have been undertaken in many parts of the world. A *major* anomaly can be defined as one that has an adverse outcome on either the function or the social acceptability of the individual ([Table 16.1](#)). In contrast, minor abnormalities are of neither medical nor cosmetic importance ([Box 16.1](#)). However, the division between major and minor abnormalities is not always straightforward; for instance, an inguinal hernia occasionally leads to strangulation of bowel and always requires surgical correction, so there is a risk of serious sequelae.

Surveys consistently show that 2% to 3% of all newborns have at least one major abnormality apparent at birth. The true incidence, taking into account abnormalities that present later in life, such as brain malformations, is probably close to 5%. Minor abnormalities are found in approximately 10% of all newborns. If two or more minor abnormalities are present in a newborn, there is a 10% to 20% risk that the baby will also have a major malformation.

The long-term outlook for a baby with a major abnormality obviously depends on the nature of the specific birth defect and whether it can be treated. The overall prognosis for this group of newborns is relatively poor, with up to 25% dying in early infancy, 25% having subsequent mental or physical

**Table 16.1** Examples of Major Congenital Structural Abnormalities

System and Abnormality	Incidence per 1000 Births
<b>Cardiovascular</b>	<b>10</b>
Ventricular septal defect	2.5
Atrial septal defect	1
Patent ductus arteriosus	1
Tetralogy of Fallot	1
<b>Central Nervous System</b>	<b>10</b>
Anencephaly	1
Hydrocephaly	1
Microcephaly	1
Lumbosacral spina bifida	2
<b>Gastrointestinal</b>	<b>4</b>
Cleft lip/palate	1.5
Diaphragmatic hernia	0.5
Esophageal atresia	0.3
Imperforate anus	0.2
<b>Limb</b>	<b>2</b>
Transverse amputation	0.2
<b>Urogenital</b>	<b>4</b>
Bilateral renal agenesis	2
Polycystic kidneys (infantile)	0.02
Bladder exstrophy	0.03

disability, and the remaining 50% having a fair or good outlook after treatment.

**Childhood Mortality**

Congenital abnormalities make a significant contribution to mortality throughout childhood. During infancy, approximately 25% of all deaths are the result of major structural abnormalities, falling to 20% between 1 and 10 years of age, and to approximately 7.5% between 10 and 15 years.

Collating the incidence data on abnormalities noted in early spontaneous miscarriages and newborns, at least 15% of all recognized human conceptions are structurally abnormal (Table 16.2), and genetic factors are probably implicated in at least 50% of these.

**Definition and Classification of Birth Defects**

So far in this chapter the terms *congenital abnormality* and *birth defect* have been used in a general sense to describe all

**Box 16.1** Examples of Minor Congenital Structural Abnormalities

- Preauricular pit or tag
- Epicanthic folds
- Lacrimal duct stenosis
- Brushfield spots in the iris
- Lip pits
- Single palmar crease
- Fifth finger clinodactyly
- Syndactyly between second and third toes
- Supernumerary nipple
- Umbilical hernia
- Hydrocele
- Sacral pit or dimple

**Table 16.2** Incidence of Structural Abnormalities

Incidence	(%)
<b>Spontaneous Miscarriages</b>	
First trimester	80–85
Second trimester	25
<b>All Babies</b>	
Major abnormality apparent at birth	2–3
Major abnormality apparent later	2
Minor abnormality	10
Death in perinatal period	25
Death in first year of life	25
Death at 1–9 years	20
Death at 10–14 years	7.5

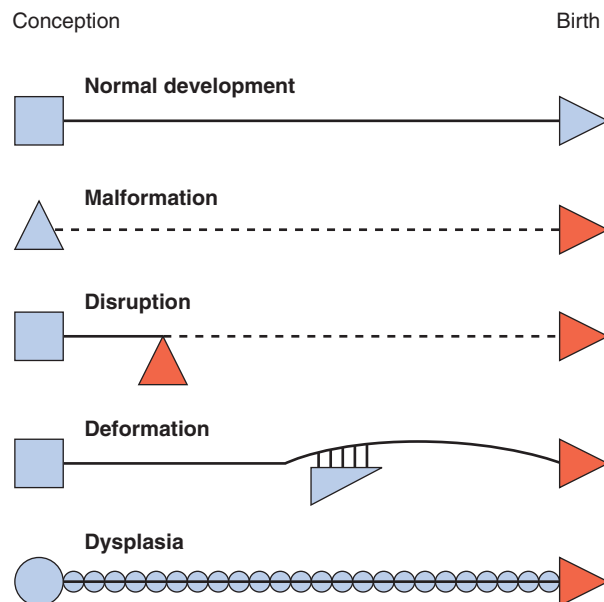
types of structural abnormality that can occur in an embryo, fetus, or newborn infant. Although these terms are perfectly acceptable for the purpose of lumping together all these abnormalities when studying their overall incidence, they do not provide any insight into possible underlying mechanisms. More specific definitions have been devised that have the added advantage of providing a combined clinical and etiological classification.

**Single Abnormalities**

Single abnormalities may have a genetic or non-genetic basis. The system of terms used helps us to understand the different mechanisms that might be implicated, and these can be illustrated in schematic form (Figure 16.1).

**Malformation**

A **malformation** is a primary structural defect of an organ, or part of an organ, that results from an inherent abnormality in development. This used to be known as a *primary* or *intrinsic*



**FIGURE 16.1** Schematic representation of the different mechanisms in morphogenesis. For malformation, disruption, and dysplasia, the broken line symbolizes developmental potential rather than timing of the manifestation of the defect, which might be late in embryogenesis. (Adapted from Spranger J, Benirschke K, Hall JG, et al 1982 *Errors of morphogenesis: concepts and terms. J Pediatr* 100:160–165.)



**FIGURE 16.2** Child with a large thoracolumbar myelomeningocele consisting of protruding spinal cord covered by meninges.

malformation. The presence of a malformation implies that the early development of a particular tissue or organ has been arrested or misdirected. Common examples include congenital heart abnormalities such as ventricular or atrial septal defects, cleft lip and/or palate, or neural tube defects (Figure 16.2). Most malformations involving only a single organ show multifactorial inheritance, implying an interaction of gene(s) with other factors (see Chapter 10). Multiple malformations are more likely to be due to chromosomal abnormalities but may be due to single gene mutations.

### Disruption

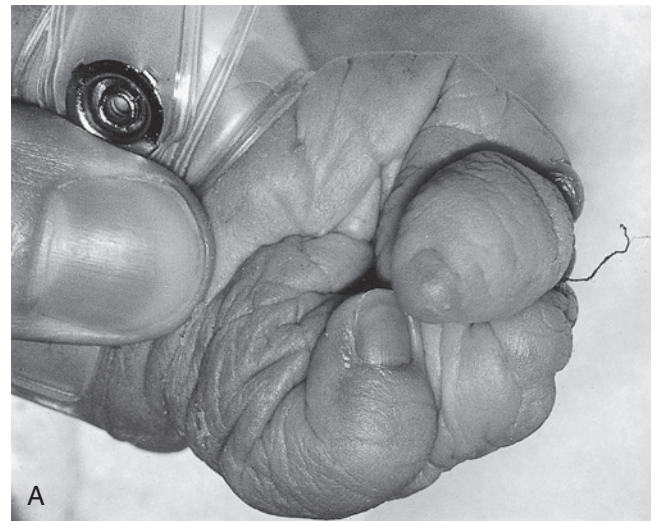
The term **disruption** refers to an abnormal structure of an organ or tissue as a result of external factors disturbing the normal developmental process. This used to be known as a *secondary* or *extrinsic* malformation, and includes ischemia, infection, and trauma. An example of a disruption is the effect seen on limb development when a strand, or band, of amnion becomes entwined around a baby's limb or digits (Figure 16.3). By definition a disruption is not genetic, although occasionally genetic factors can predispose to disruptive events. For example, a small proportion of amniotic bands are caused by an underlying genetically determined defect in collagen that weakens the amnion, making it more liable to tear or rupture spontaneously.

### Deformation

A **deformation** is a defect resulting from an abnormal mechanical force that distorts an otherwise normal structure. Examples include dislocation of the hip and mild positional talipes (club-foot) (Figure 16.4) resulting from reduced amniotic fluid (oligohydramnios) or intrauterine crowding from twinning, or a structurally abnormal uterus. Deformations usually occur late in pregnancy and carry a good prognosis with appropriate treatment—for instance, gentle splinting for talipes—because the underlying organ is fundamentally normal in structure.

### Dysplasia

A **dysplasia** is an abnormal organization or assembly of cells into tissue. The effects are usually seen wherever that particular tissue is present. For example, in thanatophoric dysplasia, a skeletal dysplasia caused by mutated *FGFR3* (pp. 113–114), almost all bones are affected (Figure 16.5). Similarly, in an



A

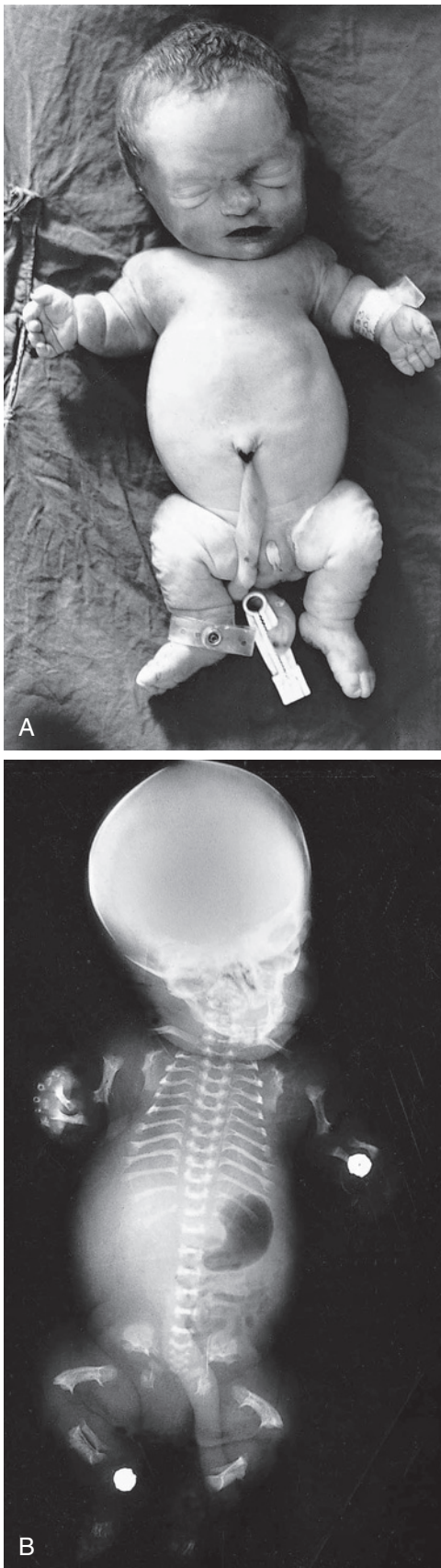


B

**FIGURE 16.3** Hand (A) and foot (B) of a baby with digital amputations resulting from amniotic bands showing residual strands of amnion. (Courtesy Dr. Una MacFadyen, Leicester Royal Infirmary, UK.)



**FIGURE 16.4** Lower limbs of a baby with talipes equinovarus.



**FIGURE 16.5** **A**, Infant with thanatophoric dysplasia. **B**, Radiograph of the infant showing short ribs, flat vertebral bodies, and curved femora.



**FIGURE 16.6** Hair (**A**) and teeth (**B**) of a male with ectodermal dysplasia.

ectodermal dysplasia, widely dispersed tissues of ectodermal origin, such as hair, teeth, skin, and nails, are involved (Figure 16.6). Most dysplasias are caused by single-gene defects and are associated with high recurrence risks for siblings and/or offspring.

### Multiple Abnormalities

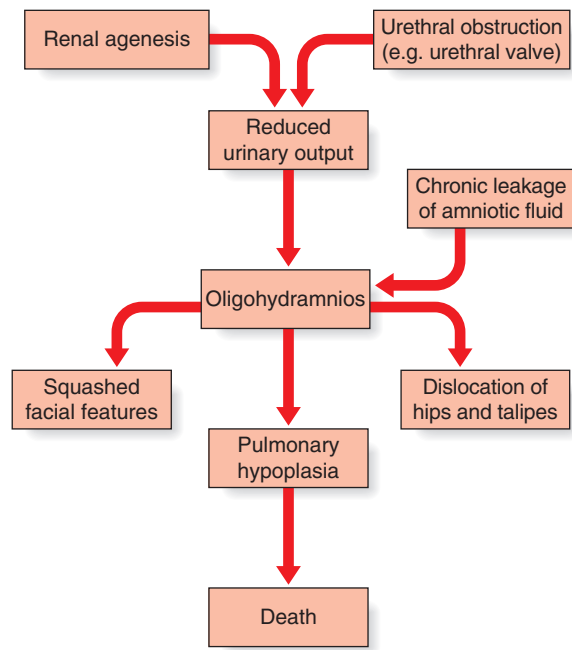
#### Sequence

This concept describes the findings that occur as a consequence of a cascade of events initiated by a single primary factor and may result in a single organ malformation. In the 'Potter' sequence, chronic leakage of amniotic fluid or defective fetal urinary output results in oligohydramnios (Figure 16.7). This in turn leads to fetal compression, resulting in flattened facial features, dislocation of the hips, talipes, and pulmonary hypoplasia (Figure 16.8), usually resulting in neonatal death from respiratory failure.

#### Syndrome

In practice the term **syndrome** is used very loosely (e.g., the amniotic band 'syndrome'), but in theory it should be reserved for consistent and recognizable patterns of abnormalities for which there will often be a known underlying cause. These underlying causes can include chromosome abnormalities, as in Down syndrome, or single gene defects, as in the Van der Woude syndrome, in which cleft lip and/or palate occurs in association with pits in the lower lip (Figure 16.9).

The clinical study of malformation syndromes is the discipline of **dysmorphology**. Clinical diagnosis has been greatly helped by the development of computerized databases (see Appendix) with a search facility based on key features. Even with the help of this extremely valuable diagnostic tool, there are many dysmorphic children for whom no diagnosis is



**FIGURE 16.7** The 'Potter' sequence showing the cascade of events leading to and resulting from oligohydramnios (reduced volume of amniotic fluid).



**FIGURE 16.8** Facial appearance of a baby with Potter sequence from oligohydramnios as a consequence of bilateral renal agenesis. Note the squashed appearance caused by in utero compression.



**FIGURE 16.9** Posterior cleft palate and lower lip pits in a child with Van der Woude syndrome.

reached, so that it can be very difficult to provide accurate information about the likely prognosis and recurrence risk (p. 318). Microarray-CGH technology and next generation sequencing (p. 63) has made inroads into this large group of undiagnosed patients and will continue to do so.

### Association

The term **association** was introduced in recognition of the fact that certain malformations tend to occur together more often than would be expected by chance, yet this non-random occurrence of abnormalities cannot be easily explained on the basis of a sequence or a syndrome. The main differences from a syndrome are the lack of consistency of abnormalities from one affected individual to another and the absence of a satisfactory underlying explanation. The names of associations are often acronyms; for example, the VACTERL association features *v*ertebral, *a*nal, *c*ardiac, *t*racheo*e*sophageal, *r*enal, and *l*imb abnormalities. Associations generally convey a low risk of recurrence and are generally thought not to be genetic. However, heterogeneity is likely and at least a proportion of cases probably have a genetic basis. In VACTERL, for example, rare cases have been described with a mutation in the X-linked gene *ZIC3*, which is also a cause of X-linked laterality (heterotaxy) defects. This in turn has led to the suggestion that VACTERL may be a condition related to inefficient laterality processes in development.

This classification of birth defects is not perfect—it is far from being either fully comprehensive or mutually exclusive. For example, bladder outflow obstruction caused by a primary malformation such as a urethral valve will result in the oligohydramnios or Potter sequence, leading to secondary deformations such as dislocation of the hip and talipes. To complicate matters further, the absence of both kidneys, which will result in the same sequence of events, is usually erroneously referred to as Potter syndrome. Despite this semantic confusion, classifications can aid understanding of causes and recurrence risks (Chapter 21), and most parents are comforted by having a name for their child's condition.

### Genetic Causes of Malformations

There are multiple causes of congenital abnormalities and the relative contribution of different mechanisms varies depending

**Table 16.3** Causes of Congenital Abnormalities

Cause	%
<b>Genetic</b>	<b>30–40</b>
Chromosomal	6
Single gene	7.5
Multifactorial	20–30
<b>Environmental</b>	<b>5–10</b>
Drugs and chemicals	2
Infections	2
Maternal illness	2
Physical agents	1
Unknown	50
Total	100

on ascertainment and the prevailing public health issues in diverse societies around the world. Table 16.3 gives a rough breakdown of the different contributing factors.

### Chromosome Abnormalities

These account for approximately 6% of all recognized congenital abnormalities, or possibly more if microarray-CGH positive cases are included. As a general rule, any perceptible degree of autosomal imbalance, such as duplication, deletion, trisomy, or monosomy, will result in severe structural and developmental abnormality, which may lead to early miscarriage. Common chromosome syndromes are described in Chapter 17. It is not known whether malformations caused by a significant chromosome abnormality, such as a trisomy, are the result of dosage effects of the individual genes involved ('additive' model) or general developmental instability caused by a large number of abnormal developmental gene products ('interactive' model).

### Single-Gene Defects

These account for up to 10% of all congenital abnormalities. Some of these are isolated—i.e., they involve only one organ or system (Table 16.4). Other single-gene defects result in multiple congenital abnormality syndromes involving many organs or systems that do not have any obvious underlying embryological relationship. For example, ectrodactyly (Figure 16.10) in isolation can be inherited as an apparent autosomal dominant trait with reduced penetrance when due to microduplications at 10q24 or 17p13.3, microdeletions at 2q31.1, or subtle imbalances at 7q21.3 (p. 104). Occasionally, autosomal recessive inheritance occurs due to mutations in *DLX5* (7q21.3). It can also occur as one manifestation of the EEC syndrome (ectodermal dysplasia, ectrodactyly and cleft lip/palate), which follows autosomal dominant inheritance and is due to mutations in *TP63*. Therefore different mutations, allelic or non-allelic, can cause similar or identical malformations.

The importance of determining a cause for a congenital abnormality, particularly if it has a single-gene basis, lies in the need for accurate genetic counseling for the immediate and wider family. In addition, from a research perspective single gene causes can provide clues to susceptibility loci for similar malformations and phenotypes that appear to show multifactorial inheritance.

From the many examples of progress in identifying the genes that cause congenital abnormalities and dysmorphic syndromes, two are now illustrated from the field of pediatric genetics. In both, the gene function in relation to widespread expression in many tissues has yet to be determined.

**Table 16.4** Congenital Abnormalities That Can Be Caused by Single-Gene Defects

	Inheritance	Abnormalities
<b>Isolated</b>		
CENTRAL NERVOUS SYSTEM		
Hydrocephalus	XR	
Megalocephaly	AD	
Microcephaly	AD/AR	
OCULAR		
Aniridia	AD	
Cataracts	AD/AR	
Microphthalmia	AD/AR	
LIMB		
Brachydactyly	AD	
Ectrodactyly	AD/AR	
Polydactyly	AD	
OTHER		
Infantile polycystic kidneys	AR	
<b>Syndromes</b>		
Apert	AD	Craniosynostosis, syndactyly
EEC	AD	Ectodermal dysplasia, ectrodactyly, cleft lip/palate
Meckel	AR	Encephalocele, polydactyly, polycystic kidneys
Roberts	AR	Cleft lip/palate, phocomelia
Van der Woude	AD	Cleft lip/palate, lip pits

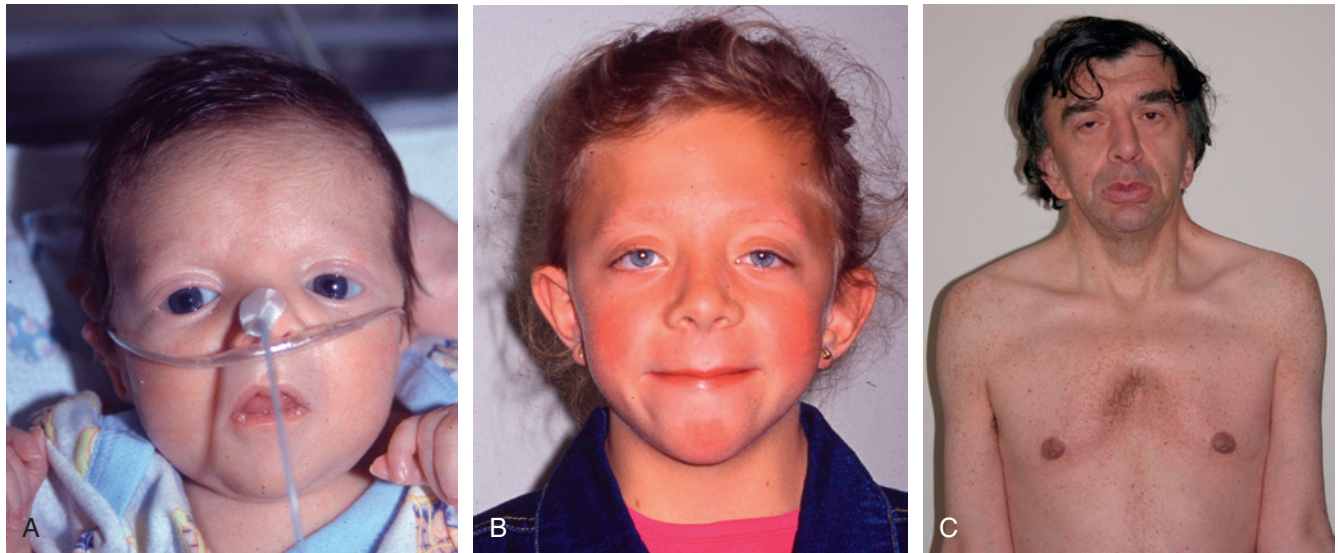
AD, Autosomal dominant; AR, autosomal recessive; XR, X-linked recessive.

### Noonan Syndrome and the 'RAS-opathies'

First described by Noonan and Ehmke in 1963, this well-known condition has incidence that may be as high as 1:2000 births, with equal sex ratio. The features resemble those of Turner syndrome in females—short stature, neck webbing, increased carrying angle at the elbow and congenital heart disease. Pulmonary stenosis is the most common lesion but atrial septal defect, ventricular septal defect, and occasionally hypertrophic cardiomyopathy occur. A characteristic mild pectus deformity may be seen, and the face shows hypertelorism, down-slanting palpebral fissures, and low-set ears



**FIGURE 16.10** Appearance of the feet in a child with ectrodactyly.



**FIGURE 16.11** Noonan syndrome: (A) in a baby presenting with cardiomyopathy at birth (which later resolved); (B) in a child; and (C) in a 57-year-old man.

(Figure 16.11). Some patients have a mild bleeding diathesis, and learning difficulties occur in approximately one-quarter.

In a three-generation Dutch family, Noonan syndrome (NS) was mapped to 12q22 in 1994, but it was not until 2001 that mutations were identified in the protein tyrosine phosphatase, non-receptor-type, 11 (*PTPN11*) gene. Attention has turned rapidly to phenotype-genotype correlation, and mutation-positive cases have a much higher frequency of pulmonary stenosis than mutation-negative cases, and very few mutations have been found in patients with cardiomyopathy. However, facial features are similar, whether or not a mutation is found. Mutations in *PTPN11* account for approximately half of all cases of NS. Mutations in the *SOS1*, *SHOC2*, *KRAS*, *RIT1*, and *MAP2K1* genes have been found in a proportion of *PTPN11*-negative cases. These genes belong to the same pathway, known as RAS-MAPK (Figure 16.12). The protein product of *PTPN11* is SHP-2 and this, together with *SOS1*, positively transduces signals to Ras-GTP, a downstream effector. The *KRAS* mutations in NS appear to lead to K-ras proteins with impaired responsiveness to GTPase activating proteins (p. 181). Neurofibromatosis, the most common disorder of this group, is dealt with in Chapter 19 (p. 279).

For years dysmorphologists recognized overlapping features between NS and the rarer conditions known as cardio-facio-cutaneous (Figure 16.13) and Costello (Figure 16.14A,B) syndromes. These conditions are now recognized to form part of a spectrum of disorders explained by mutations in different components of the RAS-MAPK pathway, with each syndrome displaying considerable genetic heterogeneity (Table 16.5). Many of the mutations are gain-of-function missense mutations, which may explain the increase in solid tumors in Costello syndrome as well as cellular proliferation in some tissues in cardio-facio-cutaneous syndrome (e.g., hyperkeratosis). The effect is for RAS to bind GTP, which results in activation of the pathway (gain-of-function). Neurofibromin is a GTPase activating protein, and functions as a tumor suppressor.

**Sotos Syndrome**

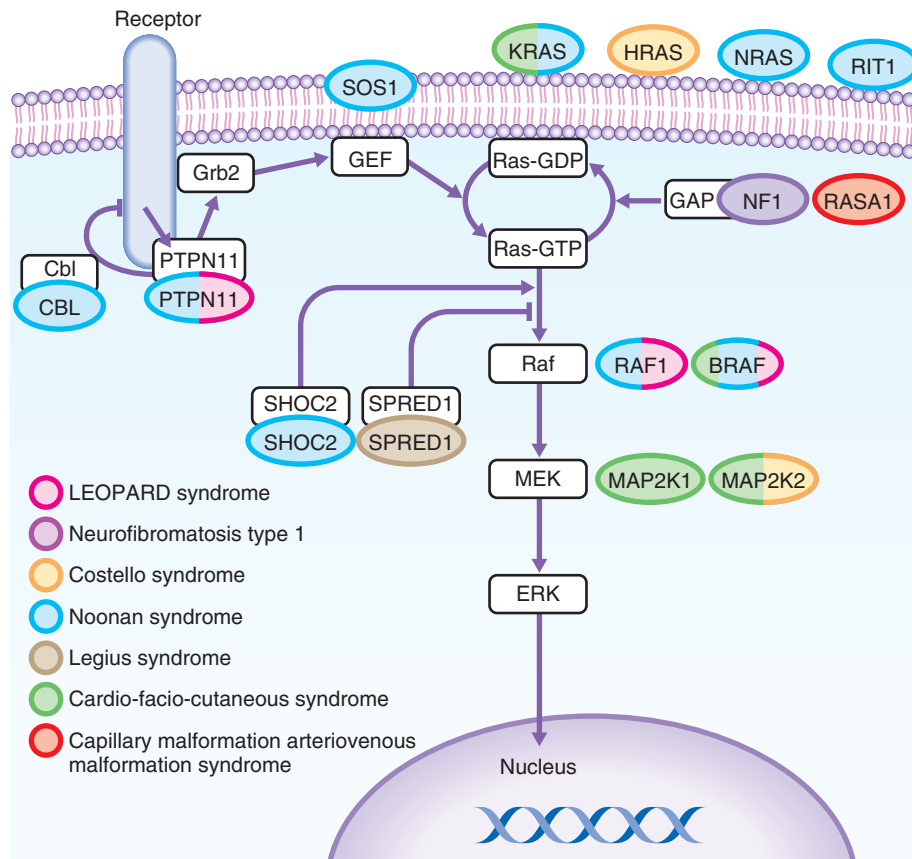
First described in 1964, this is one of the ‘overgrowth’ syndromes, previously known as cerebral gigantism. Birth weight

is usually increased and macrocephaly noted. Early feeding difficulties and hypotonia may prompt many investigations and there is often motor delay and ataxia. Height progresses along the top of, or above, the normal centile lines, but final adult height is always markedly increased. Advanced bone age may be present, as well as large hands and feet, and the cerebral ventricles may be mildly dilated on imaging. The face is characteristic (Figure 16.15), with a high prominent forehead, hypertelorism with down-slanting palpebral fissures, a characteristic nose in early childhood, and a long pointed chin. Scoliosis develops in some cases during adolescence. Parent-child transmission is rare, probably because most patients have learning difficulties, but mild cases can occur, with the result that the condition may occasionally be traced over several generations.

Among patients with Sotos syndrome reported to have balanced chromosome translocations were two with breakpoints at 5q35. From these crucial patients a Japanese group

**Table 16.5** Genes of the RAS-MAPK Pathway and Associated Syndromes

Gene	Noonan Syndrome	Cardio-Facio-Cutaneous Syndrome	Costello Syndrome
<i>PTPN11</i>	Common: ≤50% Also accounts for most cases of LEOPARD syndrome	—	—
<i>RIT1</i>	~5%	—	—
<i>KRAS</i>	Rare	Rare	Rare
<i>HRAS</i>	—	—	Common: >50%
<i>SHOC2</i>	Rare	—	—
<i>SOS1</i>	Rare	—	—
<i>BRAF</i>	—	Common: ≤50%	Some
<i>MAP2K1</i>	Rare	Some	Some
<i>MAP2K2</i>	—	Rare	—



**FIGURE 16.12** The RAS-MAPK pathway. HRAS and KRAS are activated by PTPN11 and SOS1. The pathway is dysregulated by mutations in key components, resulting in the distinct but related phenotypes of Noonan syndrome, cardio-facio-cutaneous syndrome, Costello syndrome, and neurofibromatosis type 1 (see [Table 16.5](#)). Neurofibromin is a GTPase activating (GAP) protein that functions as a tumor suppressor. Mutant RAS proteins display impaired GTPase activity and are resistant to GAPs. The effect is for RAS to bind GTP, which results in activation of the pathway (gain of function). *NF1*, Neurofibromatosis type 1.

in 2002 went on to identify a 2.2-Mb deletion in a series of Sotos syndrome cases. The deletion takes out a gene called *NSD1*, an androgen receptor-associated co-regulator with 23 exons. The Japanese found a small number of frameshift mutations in their patients but, interestingly, a study of European cases found that mutations were far more common than deletions. For the large majority of cases the mutations and deletions occur de novo.

### Multifactorial Inheritance

This accounts for the majority of congenital abnormalities in which genetic factors can clearly be implicated. These include most isolated ('non-syndromal') malformations involving the heart, central nervous system, and kidneys ([Box 16.2](#)). For many of these conditions, empirical risks have been derived ([p. 100](#)) based on large epidemiological family studies, so that it is usually possible to provide the parents of an affected child with a clear indication of the likelihood that a future child will be similarly affected. Risks to the offspring of patients who were themselves treated successfully in childhood are becoming available, particularly for congenital heart disease. These are usually similar to the risks that apply to siblings, as would be predicted by the multifactorial model (see [Chapter 10](#)).

### Genetic Heterogeneity

It has long been recognized that specific congenital malformations can have many different causes ([p. 100](#)), hence the

importance of trying to distinguish between syndromal and isolated cases. This causal diversity has become increasingly apparent as developments in molecular biology have led to the identification of highly conserved families of genes that play crucial roles in early embryogenesis.

This subject is discussed at length in [Chapter 9](#). In the current chapter, two specific malformations, holoprosencephaly and neural tube defects, will be considered to demonstrate the rate of progress in this field and the extent of the challenge that lies ahead.

### Holoprosencephaly

This severe and often fatal malformation is caused by a failure of cleavage of the embryonic forebrain or prosencephalon. Normally this divides transversely into the telencephalon and the diencephalon. The telencephalon divides in the sagittal plane to form the cerebral hemispheres and the olfactory tracts and bulbs. The diencephalon develops to form the thalamic nuclei, the pineal gland, the optic chiasm, and the optic nerves. In holoprosencephaly, there is incomplete or partial failure of these developmental processes, and in the severe alobar form this results in an abnormal facial appearance (see [Figure 9.9, p. 108](#)) with profound neurodevelopmental impairment.

Etiologically, holoprosencephaly can be classified as chromosomal, syndromal, or isolated. Chromosomal causes account for approximately 30% to 40%, the most common abnormality being trisomy 13 ([pp. 238–239](#)). Other chromosomal causes





**FIGURE 16.13** A child with cardio-facio-cutaneous syndrome due to a mutation in the *BRAF1* gene. Note the unusually curly hair.

include deletions of 18p, 2p21, 7q36, and 21q22.3, duplication of 3p24-pter, duplication or deletion of 13q, and triploidy (p. 238). Syndromal causes of holoprosencephaly are numerous and include relatively well known conditions such as the deletion 22q11 (DiGeorge) syndrome (p. 245) and a host of much rarer multiple malformation syndromes, some of which show autosomal recessive inheritance. One of these, Smith-Lemli-Opitz syndrome (pp. 107, 268), is associated with low levels

### Box 16.2 Isolated (Non-Syndromal) Malformations that Show Multifactorial Inheritance

#### Cardiac

- Atrial septal defect
- Tetralogy of Fallot
- Patent ductus arteriosus
- Ventricular septal defect

#### Central Nervous System

- Anencephaly
- Encephalocele
- Spina bifida

#### Genitourinary

- Hypospadias
- Renal agenesis
- Renal dysgenesis

#### Other

- Cleft lip/palate
- Congenital dislocation of hips
- Talipes



**FIGURE 16.14** A baby (A) with Costello syndrome due to a mutation in *HRAS* gene. The palmar creases (B) are unusually deep (picture taken in the neonatal period).

of cholesterol and is due to a defect in the early part of the Sonic hedgehog pathway (p. 107).

The third group, isolated holoprosencephaly, is sometimes explained by heterozygous mutations in three genes. The effects can be very variable, ranging from very mild with minimal features such as anosmia, to the full-blown, lethal, alobar form. The genes implicated are *Sonic hedgehog (SHH)* on chromosome 7q36, *ZIC2* on chromosome 13q32, and *SIX3* on chromosome 2p21. Of these *SHH* is thought to make the greatest contribution, accounting for up to 20% of all familial cases and between 1% and 10% of isolated cases. Some sibling recurrences of holoprosencephaly, not because of recessive Smith-Lemli-Opitz syndrome, have been shown to be due to germline mutations in these genes.



**FIGURE 16.15** Sotos syndrome. **A**, In a young child who has the typical high forehead, large head, and characteristic tip to the nose. **B**, The same individual at age 18 years, with learning difficulties and a spinal curvature (scoliosis).

That so many familial cases remain unexplained indicates that more holoprosencephaly genes await identification. Causal heterogeneity is further illustrated by its association with poorly controlled maternal diabetes mellitus (p. 227).

### Neural Tube Defects

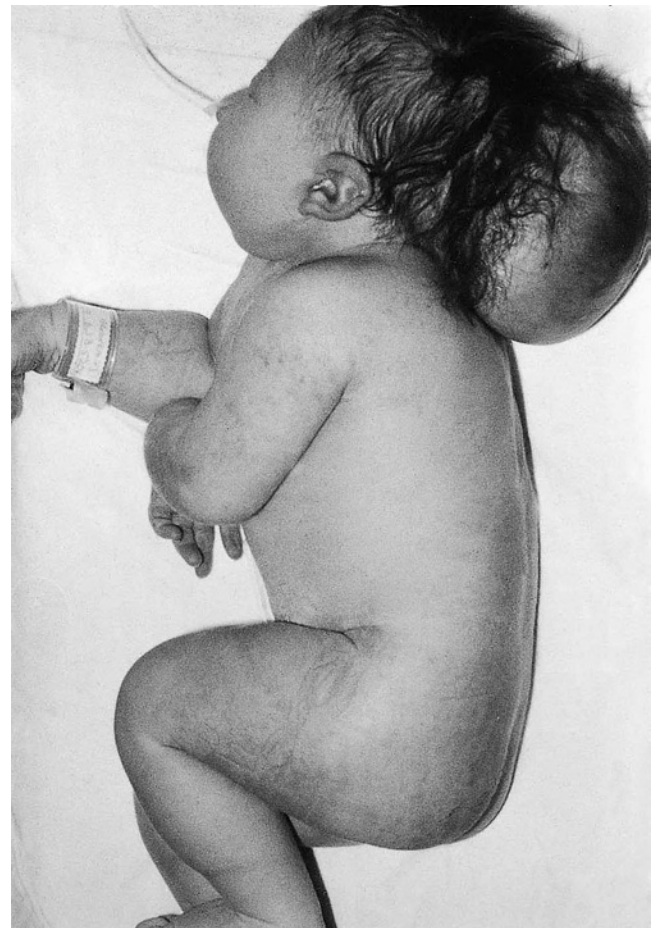
Neural tube defects (NTDs), such as spina bifida and anencephaly, illustrate many of the underlying principles of multifactorial inheritance and emphasize the importance of trying to identify possible adverse environmental factors. These conditions result from defective closure of the developing neural tube during the first month of embryonic life. A defect occurring at the upper end of the developing neural tube results in either exencephaly/anencephaly or an encephalocele (Figure 16.16). A defect occurring at the lower end of the developing neural tube leads to a spinal lesion such as a lumbosacral meningocele or myelomeningocele (see Figure 16.2), and a defect involving the head plus cervical and thoracic spine leads to craniorachischisis. These different entities relate to the

different embryological closure points of the neural tube. Most NTDs have serious consequences. Anencephaly and craniorachischisis are not compatible with survival for more than a few hours after birth. Large lumbosacral lesions usually cause partial or complete paralysis of the lower limbs with impaired bladder and bowel continence.

As with many malformations, NTDs can be classified etiologically under the headings of chromosomal, syndromal, and isolated. Chromosomal causes include trisomy 13 and trisomy 18, in both of which NTDs show an incidence of approximately 5% to 10%. Syndromal causes include the relatively rare autosomal recessive disorder, Meckel-Gruber syndrome, characterized by encephalocele in association with polycystic kidneys and polydactyly. However, most NTDs represent isolated malformations in otherwise normal infants, and appear to show multifactorial inheritance.

The empiric recurrence risks to first-degree relatives (siblings and offspring) vary according to the local population incidence and are as high as 4% to 5% in areas where NTDs are common. The incidence in the United Kingdom is highest in people of Celtic origin. If such individuals move from their country of origin to another part of the world, the incidence in their offspring declines but remains higher than among the indigenous population. These observations suggest the presence of susceptibility genes in Celtic populations.

No single NTD susceptibility genes have been identified in humans, although there is some evidence that the common 677C > T polymorphism in the *Methylenetetrahydrofolate*



**FIGURE 16.16** A baby with a large occipital encephalocele.

*reductase* (*MTHFR*) gene can be a susceptibility factor in some populations. Reduction in *MTHFR* activity results in decreased plasma folate levels, which are known to be causally associated with NTDs (see the following section). Research efforts have also focused on developmental genes, such as the *PAX* family (p. 109), which are expressed in the embryonic neural tube and vertebral column. In mouse models, approximately 80 genes have been linked to exencephaly, approximately 20 genes to lumbosacral myelomeningocele, and approximately 5 genes to craniorachischisis. One example is an interaction between mutations of *PAX1* and the *Platelet-derived growth factor  $\alpha$*  gene (*PDGFRA*) that results in severe NTDs in 100% of double-mutant embryos. This rare example of digenic inheritance (p. 75) serves as a useful illustration of the difficulties posed by a search for susceptibility genes in a multifactorial disorder. However, to date there have been no equivalent breakthroughs in understanding the processes in human NTDs.

Environmental factors include poor socioeconomic status, multiparity, and valproic acid embryopathy (pp. 227–228, Figure 16.19). Firm evidence has also emerged that periconceptional multivitamin supplementation reduces the risk of recurrence by a factor of 70% to 75% when a woman has had one affected child. Several studies have shown that folic acid is likely to be the effective constituent in multivitamin preparations and the World Health Organization recommends periconceptional folate supplementation of 400  $\mu\text{g}/\text{day}$ , which is adopted in some form by most nations. In some countries, including the USA, bread is fortified with folic acid. Many nations officially recommend that all women who have previously had a child with an NTD should take 4 to 5 mg of folic acid daily both before conceiving and throughout the first trimester.

### Environmental Agents (Teratogens)

An agent that can cause a birth defect by interfering with normal embryonic or fetal development is known as a teratogen. Many teratogens have been identified and exhaustive tests are now undertaken before any new drug is approved for use by pregnant women. The potential effects of any particular teratogen usually depend on the dosage and timing of administration during pregnancy, along with the susceptibility of both the mother and fetus.

An agent that conveys a high risk of teratogenesis, such as the rubella virus or thalidomide, can usually be identified relatively quickly. Unfortunately, it is much more difficult to detect a low-grade teratogen that causes an abnormality in only a small proportion of cases. This is because of the relatively high background incidence of congenital abnormalities, and also because many pregnant women take medication at some time in pregnancy, often for an ill-defined 'flu-like' illness. Despite extensive study, controversy still surrounds the use of a number of drugs in pregnancy. The anti-nausea drug *Debendox* was the subject of successful litigation in the United States despite a lack of firm evidence to support a definite teratogenic effect. A group of drugs under scrutiny more recently is the selective serotonin reuptake inhibitors, or SSRIs. These are commonly prescribed antidepressants and in Europe some 3% of pregnant women take antidepressants, rising to approximately 8% in the United States. Despite concerns about a teratogenic potential, particularly congenital heart disease, several large studies have failed to demonstrate a significant difference in the frequency of birth defects.

**Table 16.6** Drugs With a Proven Teratogenic Effect in Humans

Drug	Effects
ACE inhibitors	Renal dysplasia
Alcohol	Cardiac defects, microcephaly, characteristic facies
Chloroquine	Chorioretinitis, deafness
Diethylstilbestrol	Uterine malformations, vaginal adenocarcinoma
Lithium	Cardiac defects (Ebstein anomaly)
Phenytoin	Cardiac defects, cleft palate, digital hypoplasia
Retinoids	Ear and eye defects, hydrocephalus
Streptomycin	Deafness
Tetracycline	Dental enamel hypoplasia
Thalidomide	Phocomelia, cardiac and ear abnormalities
Valproic acid	Neural tube defects, clefting, limb defects, characteristic facies
Warfarin	Nasal hypoplasia, stippled epiphyses

ACE, Angiotensin-converting enzyme.

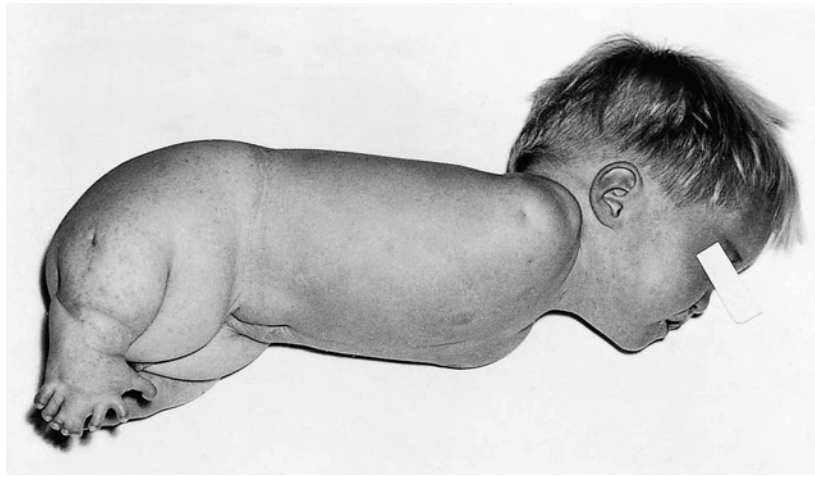
### Drugs and Chemicals

Drugs and chemicals with a proven teratogenic effect in humans are listed in Table 16.6. These may account for approximately 2% of all congenital abnormalities. Many drugs have been proposed as possible teratogens, but if taken only rarely in pregnancy, and the numbers of reported cases even smaller, it is difficult to confirm a damaging effect. This applies to many anticancer drugs, including methotrexate. Whilst still controversial, case reports suggest a methotrexate embryopathy can occur, including growth deficiency, microcephaly, various craniofacial abnormalities, limb anomalies and deficiencies, and possibly tetralogy of Fallot. Controversy always surrounds the use of agents deployed in warfare, such as dioxin (Agent Orange) in Vietnam and various nerve gases in the Gulf War.

### The Thalidomide Tragedy

Thalidomide was used widely in Europe during 1958 to 1962 as a sedative. In 1961 an association with severe limb anomalies in babies whose mothers had taken the drug during the first trimester was recognized and the drug was subsequently withdrawn from use. It is possible that more than 10,000 babies were damaged over this period. Review of these babies' records indicated that the critical period for fetal damage was between 20 and 35 days postconception (i.e., 34 to 50 days after the beginning of the last menstrual period). Unfortunately, thalidomide was reintroduced in Brazil as a treatment for leprosy and despite warnings about its teratogenicity a significant cohort of younger 'Thalidomiders' now exists.

The most characteristic abnormality caused by thalidomide was phocomelia (Figure 16.17). This is the name given to a limb that is malformed due to absence of some or all of the long bones, with retention of digits giving a 'flipper' or 'seal-like' appearance. Other external abnormalities included ear defects, microphthalmia and cleft lip/palate. In addition, approximately 40% died in early infancy from severe internal abnormalities affecting the heart, kidneys, or gastrointestinal tract. Many Thalidomiders have grown up and had children of their own, and in some cases these offspring have also had similar defects. It is therefore most likely, not surprisingly, that thalidomide was wrongly blamed in a proportion of cases that were in fact from single-gene conditions following



**FIGURE 16.17** A child with thalidomide embryopathy. There is absence of the upper limbs (amelia). The lower limbs show phocomelia and polydactyly. (Courtesy Emeritus Professor R. W. Smithells, University of Leeds, UK)

autosomal dominant inheritance (e.g., *SALL4* mutations [see Figure 9.25C, p. 120] in Okihiro syndrome [p. 118]).

The thalidomide tragedy focused attention on the importance of avoiding all drugs in pregnancy as far as is possible, unless absolute safety has been established. Drug manufacturers undertake extensive research trials before releasing a drug for general use, and invariably urge caution about the use of any new drug in pregnancy. Monitoring systems, in the form of congenital abnormality registers, have been set up in most Western countries so that it is unlikely that an ‘epidemic’ on the scale of the thalidomide tragedy could ever happen again.

### Fetal Alcohol Syndrome

Children born to mothers who have consistently consumed large quantities of alcohol during pregnancy tend to have a small head circumference, a distinctive facial appearance with short palpebral fissures, a long smooth philtrum and a thin upper lip

(Figure 16.18A,B). The ear helix may show a ‘railroad’ configuration of the folds, and in the hands a ‘hockey-stick’ crease may be present (see Figure 16.18C). They also show developmental delay with hyperactivity and a reduced sense of moral responsibility, resulting in altercations with civil authorities as they get older. This may be referred to as ‘fetal alcohol spectrum disorder’, and if the physical aspects are lacking, ‘alcohol-related neurodevelopmental defects’ may be applied. There is uncertainty about the ‘safe’ level of alcohol consumption in pregnancy and there is evidence that mild-to-moderate ingestion can be harmful. Thus, total abstinence is advised throughout pregnancy.

### Maternal Infections

Several infectious agents can interfere with embryogenesis and fetal development (Table 16.7). The developing brain, eyes, and ears are particularly susceptible to damage by infection.



**FIGURE 16.18** **A** and **B**, Two children with fetal alcohol syndrome, showing short palpebral fissures, a long smooth philtrum, and thin upper lip. Although unrelated to each other, they bear a close resemblance. **C**, A ‘hockey-stick’ crease of the palm extending into the interdigital space between the index and middle fingers.

**Table 16.7** Infectious Teratogenic Agents

Infection	Effects
<b>Viral</b>	
Cytomegalovirus	Chorioretinitis, deafness, microcephaly
Herpes simplex	Microcephaly, microphthalmia
Rubella	Microcephaly, cataracts, retinitis, cardiac defects
Varicella zoster	Microcephaly, chorioretinitis, skin defects
<b>Bacterial</b>	
Syphilis	Hydrocephalus, osteitis, rhinitis
<b>Parasitic</b>	
Toxoplasmosis	Hydrocephalus, microcephaly, cataracts, chorioretinitis, deafness

## Rubella

The rubella virus, which damages 15% to 25% of all babies infected during the first trimester, causes cardiovascular malformations such as patent ductus arteriosus and peripheral pulmonary artery stenosis. Congenital rubella infection can be prevented by the widespread use of immunization programs based on administration of either the measles, mumps, rubella vaccine in early childhood or rubella vaccine alone to young adult women.

## Cytomegalovirus

At present no immunization is available against cytomegalovirus and naturally occurring infection does not always produce long-term immunity. The risk of abnormality is greatest when infection occurs during the first trimester. Overall this virus causes damage in approximately 5% of infected pregnancies.

## Toxoplasmosis

Maternal infection with the parasite causing toxoplasmosis conveys a risk of 20% that the fetus will be infected during the first trimester, rising to 75% in the second and third trimesters. Vaccines against toxoplasmosis are not available.

Investigation for possible congenital infection can be made by sampling fetal blood to look for specific immunoglobulin-M antibodies. Fetal blood analysis can also reveal generalized evidence of infection, such as abnormal liver function and thrombocytopenia.

There is some evidence to suggest that maternal infection with *Listeria* can cause a miscarriage, and a definite association has been established between maternal infection with this agent and neonatal meningitis. Maternal infection with parvovirus can cause severe anemia in the fetus, resulting in hydrops fetalis and pregnancy loss.

## Physical Agents

Women who have had babies with congenital abnormalities usually scrutinize their own history in great detail and ask about exposure to agents such as radio waves, ultrasound, magnetic fields, various chemicals and medicines, as well as minor trauma. It is invariably impossible to prove or disprove causal link but there is some evidence that two specific physical agents, ionizing radiation and prolonged hyperthermia, can have teratogenic effects.

## Ionizing Radiation

Heavy doses of ionizing radiation, far in excess of those used in routine diagnostic radiography, can cause microcephaly and

ocular defects in the developing fetus. The most sensitive time of exposure is 2 to 5 weeks post-conception. Ionizing radiation can also have mutagenic (p. 21) and carcinogenic effects and, although the risks associated with low-dose diagnostic procedures are minimal, radiography should be avoided during pregnancy if possible.

## Prolonged Hyperthermia

There is evidence that prolonged hyperthermia in early pregnancy can cause microcephaly and microphthalmia as well as neuronal migration defects. Consequently, it is recommended that care should be taken to avoid excessive use of hot baths and saunas during the first trimester.

## Maternal Illness

Several maternal illnesses are associated with an increased risk of an untoward pregnancy outcome.

## Diabetes Mellitus

Maternal diabetes mellitus is associated with a two- to three-fold increase in the incidence of congenital abnormalities in offspring. Malformations that occur most commonly in such infants include congenital heart disease, neural tube defects, vertebral segmentation defects and sacral agenesis, femoral hypoplasia, holoprosencephaly, and sirenomelia ('mermaidism'). The likelihood of an abnormality is inversely related to the control of the mother's blood glucose levels during early pregnancy, which should be regularly monitored by testing plasma glucose and glycosylated hemoglobin levels.

## Phenylketonuria

Another maternal metabolic condition that conveys a risk to the fetus is untreated phenylketonuria (p. 255). A high serum level of phenylalanine in a pregnant woman with phenylketonuria will almost invariably result in serious damage (e.g., intellectual disability). Structural abnormalities may include microcephaly and congenital heart defects. All women with phenylketonuria should be strongly advised to adhere to a strict and closely monitored low phenylalanine diet before and throughout pregnancy.

## Maternal Epilepsy

There is a large body of literature devoted to the question of maternal epilepsy, the link with congenital abnormalities, and the teratogenic effects of antiepileptic drugs (AEDs). The largest and best controlled studies suggest that maternal epilepsy itself is not associated with an increased risk of congenital abnormalities. However, all studies have shown an increased incidence of birth defects in babies exposed to AEDs. The risks are in the region of 5% to 10%, which is two to four times the background population risk. These figures apply mainly to single drug therapy, but may be higher if the fetus is exposed to more than one AED. Some drugs are more teratogenic than others, with the highest risks applying to sodium valproate. The range of abnormalities occurring in the 'fetal valproate syndrome' (FVS) is wide, including neural tube defect (up to 2%), oral clefting, genitourinary abnormalities such as hypospadias, congenital heart disease, and limb defects. The abnormalities themselves are not specific to FVS, and making a diagnosis in an individual case can therefore be difficult. Characteristic facial features may also be present in FVS (Figure 16.19), which strongly supports a clinical diagnosis.



**FIGURE 16.19** A child with fetal valproate syndrome. She has a broad nasal root, blunt nasal tip, and a thin upper lip.

The most controversial aspect of AEDs and FVS has been the risk of learning difficulties and behavioral problems. However, well controlled prospective studies have provided convincing evidence that prenatal exposure to sodium valproate carries a significant risk of neurodevelopmental and behavioral sequelae. But potential risks to the fetus must be weighed against the dangers of stopping AED treatment and risking seizures during pregnancy. If the patient has been seizure-free for at least 2 years, she can be offered withdrawal of anticonvulsant medication before proceeding with a pregnancy. If therapy is essential, then single-drug treatment is much preferred and sodium valproate should be avoided if possible.

### Malformations of Unknown Cause

In up to 50% of all congenital abnormalities no clear cause can be established. This applies to many relatively common conditions such as orofacial clefting, congenital heart disease, isolated diaphragmatic hernia, tracheoesophageal fistula, anal atresia, and limb anomalies. For an isolated limb reduction defect, such as absence of a hand, disruption of vascular supply at a critical time during the development of the limb bud can lead to developmental arrest, perhaps with the formation of only vestigial digits. This mechanism may sometimes apply to other organ malformations, though is usually less certain.

### Symmetry and Asymmetry

When trying to assess whether a birth defect is genetic or non-genetic, it may be helpful to consider aspects of symmetry. As a very broad generalization, symmetrical and midline abnormalities frequently have a genetic basis. Asymmetrical defects are less likely to have a genetic basis. In the examples shown in [Figure 16.20](#), the child with cleidocranial dysplasia (see [Figure 16.20A](#)) has symmetrical defects (absent or hypoplastic clavicles) and other features indicating a generalized tissue disorder that is overwhelmingly likely to have a genetic basis. The striking asymmetry of the limb deformities in [Figure 16.20B](#) is likely to have a non-genetic basis.



**FIGURE 16.20 A**, A boy with cleidocranial dysplasia in whom the clavicles have failed to develop, hence the remarkable mobility of his shoulders. He also has a relatively large head with widely spaced eyes (hypertelorism). He presented with ear problems—conductive deafness is a recognized feature. Skeletal dysplasias usually manifest in one main tissue and are symmetrical, suggesting a genetic basis. **B**, A child with congenital limb deformities from amniotic bands. The marked asymmetry suggests a non-genetic cause.

## Counseling

In cases where the precise diagnosis is uncertain, an assessment of symmetry and midline involvement may be helpful for genetic counseling. Although it may be very frustrating that no detailed explanation is possible, in many cases reassurance about a low recurrence risk in a future pregnancy can be given, based on empirical data. It is worth noting that this does not necessarily mean that genetic factors are irrelevant. Some ‘unexplained’ malformations and syndromes could well be due to new dominant mutations (p. 69), submicroscopic microdeletions (p. 245), or uniparental disomy (p. 77). All of these would convey negligible recurrence risks to future siblings, although with new mutations or microdeletions a significant risk (usually 50%) applies to the offspring of affected individuals. Increasingly, as discussed elsewhere, access to next generation sequencing methods, particularly whole exome sequencing, is providing answers to some of these difficult cases, especially where moderate or severe learning disability is the dominant aspect of the syndrome.

## Learning Disability

Learning, or *intellectual*, disability is a huge part of clinical genetic practice and the numerous causes are woven into many other chapters of this book, e.g., chromosome disorders (Chapter 17), developmental genetics (Chapter 9), and inborn errors of metabolism (Chapter 18). The genetic basis of learning disability (LD), especially at the severe end of the spectrum, is increasingly being identified through microarray-CGH and next generation sequencing techniques, but there are many non-genetic causes such as cerebral palsy, and teratogens as discussed in this chapter. Clinical geneticists tend to view LD in the context of a syndrome or its genetic cause, but for the patients themselves, their families and carers, and other professionals, the issues of daily life, support, and managing often difficult circumstances, are all-consuming. Having a child with LD may bring the mother’s or father’s career and earning capacity to an end.

The terminology of LD generate much discussion as there is increasing sensitivity about political correctness and a concern to enhance the value of individuals with any sort of disability to help them fight discrimination, a process to which clinical geneticists can contribute significantly. Approximately 2% to 3% of the population have mild to moderate LD and 0.5% to 1% of the population have LD in the moderate to severe range. The measurement of intelligence quotient (IQ) is problematic but across the population follows a normal distribution with the mean conventionally set at 100. Mild LD is defined as an IQ of 50–70, moderate 35–49, severe 20–34, and profound LD (or mental retardation) as an IQ of less than 20. However, there are many types of LD and much academic effort has been invested into developing classification systems as well as the tools to dissect and describe the many different *specific* disabilities, though for many patients with genetic conditions the term *global developmental delay* often applies.

### X-Linked Intellectual Disability (XLID)

Previously known as X-linked mental retardation, this refers to LD associated with genetic variants on the X-chromosome. It was recognized in the 1930s that there was a 25% excess of males with severe LD in institutions and later calculated in British Columbia that the incidence of XLID was 1.83 per 1000 live male births with a carrier frequency of 2.44 per 1000

live female births. By 2006, 24 X-linked genes were identified, both syndromic and non-syndromic, but that figure now exceeds 100. Individually these conditions are rare, with the exception of fragile-X syndrome, which is covered in Chapter 17. They also include a proportion of genes implicated in X-linked dominant conditions, which very often occur as de novo mutations, of which Rett syndrome is the best known but others are becoming well recognized.

### Autistic Spectrum Disorder (ASD)

In 1943 Dr. Leo Kanner provided the first succinct description of autism when he wrote, “*These children come into the world with the innate inability to form the usual biologically provided affective contact with people ... an inability to relate themselves in the ordinary way to people and situations from the beginning of life ...*”, and, “*There is from the start an extreme autistic aloneness that, whenever possible, disregards, ignores, shuts out anything that comes into the child from the outside.*” A year later Dr Hans Asperger noted, “*... in every instance where it is possible to make a close study similar traits were to be found in some degree in parents and other relatives.*” These elegant observations encompass the key features of ASD, namely impaired development of: (1) selective **social** attachments; (2) expressive or receptive language used for social **communication**; and (3) functional or symbolic play **behavior**—as well, of course, as the issue of **heritability**.

Today the diagnostic criteria for ASD are detailed and the assessment lengthy and sophisticated (Box 16.3), and ASD is sometimes classified with other so-called ‘pervasive developmental disorders’. The epidemiological aspects of ASD are shown in Box 16.4. There is also a paternal age-related effect: for children born to fathers  $\geq 45$  years old the risk of developing ASD is three to four times higher than for children born to

#### Box 16.3 Diagnostic Criteria for Autistic Spectrum Disorder (DSM-IV)

**Abnormal or impaired development at less than 3 years of age in one or more of:**

- Development of selective **social** attachments
- Expressive or receptive language used for social **communication**
- Functional or symbolic play—**behavior**

*For a diagnosis the child must have six or more of the following:*

#### **Social ( $\geq 2$ ):**

- Failure of eye-to-eye gaze
- Failure of peer relationships—interests, activities, emotions
- Failure to recognize social norms
- Failure to share enjoyment

#### **Communication ( $\geq 1$ ):**

- Speech delay and failure to compensate by gesture
- Failure to sustain conversation or reciprocate
- Stereotypic/repetitive use of language
- Lack of make-believe imitative play

#### **Behavior ( $\geq 1$ ):**

- Preoccupations—restricted patterns of interest
- Compulsivity
- Stereotypic/repetitive motor mannerisms (e.g., hand flapping)
- Preoccupations with non-functional elements (e.g., odor, touch)

### Box 16.4 Epidemiology of Autistic Spectrum Disorder

#### Frequency:

Classical Autism (severe):	1.7 in 1000
Autism, Asperger & Pervasive Developmental Disorders:	3.4–6.3 in 1000

#### Male:Female ratio:

Overall:	4:1
Asperger syndrome:	8:1
Severe autism:	1:1 (approx.)

#### Twin and sibling studies (broad ASD phenotype):

MZ twin concordance:	approximately 92%
DZ twin concordance:	approximately 10%
Sibling recurrence risk	3% to 6% (25x background risk)

#### Other features:

Epilepsy occurs in 25% to 30%, suggesting an underlying neurodevelopmental disorder  
Head circumference is in the upper centiles in approximately 25%

fathers aged 20 to 24. Evidence for heritability is incontrovertible and twin studies have been key to our understanding. For classical autism, monozygotic (MZ) twins demonstrate a concordance rate of approximately 60%, whilst the rate for dizygotic (DZ) twins is 0%. When the broader phenotype is examined, this becomes approximately 92% for MZ twins and approximately 10% for DZ twins. The sibling recurrence risk for the broad ASD phenotype is up to 6%. Overall, the heritability of ASD is estimated to be greater than 90%.

The data are convincing but the search for precise genetic causative factors, mainly using genome-wide association studies, has been far from fruitful, despite the combined efforts of large consortia worldwide. Multiple different loci have been implicated, indicating extreme genetic heterogeneity. The exception to this otherwise confusing picture has been the clear association with various copy number variants identified through microarray-CGH analysis, giving rise to new microdeletion and microduplication syndromes, some of which are described in Chapter 17.

### Some Classic and New Learning Disability Syndromes

This is a vast area of clinical genetics and for many classic LD syndromes the reader must explore other chapters of this book. This section highlights some that are not covered elsewhere as well as a small number of newer conditions identified through next generation sequencing.

#### Cornelia de Lange Syndrome (CdLS)

This distinctive condition owes its name to the observations of the outstanding Dutch pediatrician in Amsterdam, Cornelia de Lange, in 1933, though was earlier reported by Brachmann in 1916, hence it is also known as Brachmann-de Lange syndrome. The facial features are very recognizable when classically present, consisting of characteristic eyebrows—neat, arched, and meeting in the middle (synophrys), a crescent-shaped mouth with thin lips, and a long philtrum (Figure 16.21A,B). In addition, the hands are very useful in either confirming or refuting a clinical diagnosis—short tapering fingers, especially the fifth, with clinodactyly, and the thumbs are usually small and proximally placed (Figure 16.21C). In approximately a

quarter of cases there may be a severe upper limb deficiency, often unilateral, such that monodactyly arises from a short forearm. LD is profound in up to half of all affected individuals, as well as behavior problems such as self-injury and aggression, but can be very mild in perhaps 10%, so marked variability occurs. Congenital heart disease, diaphragmatic hernia, and intestinal malrotation may be present, and feeding difficulties are a common management issue.

In 2004 heterozygous mutations were found in the first (and main) gene for CdLS, namely *NIPBL*, a homolog of *Drosophila Nipped-B*, which encodes a ‘cohesin’ protein. The associated protein complex is required for normal sister chromatid cohesion in cell division. Since then mutations have been found in other genes in patients with CdLS-like features, including *SMC3* and X-linked *SMC1A* (see below), which may account for approximately 5% of cases.

#### CHARGE Syndrome

CHARGE used to be considered an *association* and is an acronym for *coloboma* of iris or retina, *congenital heart defects*, *atresia* of the choanae, *retardation* of growth and development, *genital anomalies* (males), and *ear abnormalities* (including deafness), though not all patients manifest all features. Tracheo-esophageal fistula is an occasional complication, as well as clefting and facial asymmetry (Figure 16.22). LD can range from severe to mild and occasional parent-child transmission has been reported.

Since the finding of heterozygous mutations in the *CHD7* gene the condition is now regarded as a syndrome rather than an association, and a second gene, *SEMA3E*, has been implicated. *CHD7*, also known as *KIAA1416*, is a positive regulator of the production of ribosomal RNA in the nucleolus.

#### Kabuki Syndrome

First described in 1981 in Japan, this condition was so named because patients’ faces resembled the make-up worn by actors of the traditional Japanese Kabuki theatre. Indeed, for some time it was known as Kabuki make-up syndrome, as well as Niikawa-Kuroki syndrome after the scientists. Apart from the distinctive facies (Figure 16.23A,B) and mild-moderate LD, patients are typically hypermobile and hypotonic, may have congenital heart disease—particularly of the left outflow tract, suffer sensorineural hearing impairment, show digital anomalies (Figure 16.23C) including persistent fetal finger pads, have renal tract anomalies, and occasionally diaphragmatic hernia. Some present in the neonatal period with hypoglycemia due to hyperinsulinism.

After a number of false trails looking for the cause of Kabuki syndrome, mutations in the gene *KMT2D* (previously *MLL2*), encoding a histone methyltransferase, were confirmed as the cause in many patients in 2010. Subsequently, in 2013, heterozygous mutations in the X-linked gene *KDM6A*, encoding a histone demethylase, were also found to cause Kabuki syndrome in a proportion of patients. Both of these genes are chromatin modifiers and the clue to their involvement came from patients that had chromosomal imbalances at the respective loci. *KDM6A* is unusual because it escapes X-inactivation at Xp11.3 and haploinsufficiency is probably the pathogenic basis. Up to 30% of Kabuki syndrome cases remain unexplained.

#### Mowat-Wilson Syndrome

This condition also has distinctive facial features (Figure 16.24) and finally emerged as a discrete entity in 2003 after a few





**FIGURE 16.21** **A**, A child aged 2 months with typical Cornelia de Lange Syndrome (CdLS). **B**, A young adult with CdLS and, **C**, his hands showing small thumbs, fifth fingers and short nails.

earlier reports had gathered together similar patients with severe LD, Hirschsprung disease, microcephaly, absent speech, and agenesis of the corpus callosum. Congenital heart disease, particularly right outflow tract anomalies, may occur, as well as microphthalmia, hypospadias in males, and seizures.

Chromosomal imbalances were again the clue to the genetic locus at 2q22; indeed, some cases are the result of microdeletions whilst others are due to heterozygous mutations in *ZEB2* (previously *SIP-1*, or *ZFHX1B*). The gene is a DNA-binding transcriptional repressor that interacts with the histone deacetylation complex via SMADs and the TGF- $\beta$  signaling pathway (p. 105).

### Pitt-Hopkins Syndrome

In 1978 Drs Pitt and Hopkins reported patients with severe LD, macrostomia and episodes of over-breathing. They also have microcephaly, sometimes agenesis of the corpus callosum, and cerebellar hypoplasia. They may have seizures, constipation or frank Hirschsprung disease, and hypogonadism in males.

Through a microdeletion at 18q21 detected in one patient through microarray-CGH, heterozygous mutations in the gene *TCF4* was identified as the cause. *TCF4* encodes a basic helix-loop-helix (bHLH) transcription factor. A child with the condition is shown in Figure 16.25.

### Wiedemann-Steiner Syndrome

Originally reported in 1985 and 2000 without much follow-up this syndrome burst on the scene, so to speak, in 2012 with the finding of heterozygous mutations in the *MLL1* gene, now reassigned *KMT2A*. Like *MLL2* (*KMT2D*, Kabuki syndrome), this gene is a lysine-specific methyltransferase, a DNA-binding protein which in this case methylates histone H3.



**FIGURE 16.22** A young child with CHARGE syndrome and a mutation in the *CHD7* gene.



**FIGURE 16.23** **A**, A 2-year-old child with Kabuki syndrome, and **B**, the same child aged 8 years. Note interrupted eyebrows, prominent ears, and everted lateral third of the lower eyelid. **C**, The left hand of the same child, showing some shortening and tapering of the fingers, especially the fifth, which also has a small nail.

The syndrome itself is characterized by LD to a variable degree, significant feeding difficulties, hypotonia and constipation in early childhood, and quite striking hypertrichosis of the back and forearms. The eyebrows tend to be thick and sometimes meet in the middle (synophrys), the eyelashes long, the palpebral fissures narrow and slightly down-slanting, the nasal bridge is broad, and there may be hypertelorism (Figure 16.26). Stature tends to be short, and autistic features are part of the behavior disorder.

### Genitopatellar Syndrome

Along with the so-called Say-Barber-Biesecker-Young-Simpson variant of Ohdo syndrome, genitopatellar syndrome is the other major phenotype due to heterozygous mutations in the *KAT6B* gene, which encodes a histone acetyltransferase. Both

conditions, like the one previously discussed, suddenly had a high profile in 2011–2012 when next generation sequencing linked them to the gene.

Genitopatellar syndrome is characterized by severe LD, microcephaly, agenesis of the corpus callosum and neuronal migration defects, small patellae, hypogenitalism in males, renal tract anomalies, occasional dextrocardia and intestinal malrotation, and osteoporosis with consequent fractures. Facial features include hypertelorism (Figure 16.27A) and the thumbs and great toes are typically long (see Figure 16.27B,C).

### Coffin-Siris Syndrome—*ARID1B*

Coffin-Siris syndrome is sufficiently variable that it is hard to believe that some patients are grouped with others under the same label, and it is also genetically heterogeneous with at least



**FIGURE 16.24** Mowat-Wilson syndrome. **A**, A young child aged 1 year. Note the prominent supra-orbital ridges, deep-set eyes and prominent mandible. **B**, The same child aged 7 years.



**FIGURE 16.25** A child with Pitt-Hopkins syndrome. Note the macrostomia.

five genes implicated in those with the diagnosis—*ARID1A*, *ARID1B*, *SMARCA4*, *SMARCB1*, and *SMARCE1*. Conventionally, the key clinical features are LD, which can range from mild to severe and include very limited language development, hypoplasia of the fifth digit distal phalanx and nail, and rather coarse facies with hirsute features affecting the eyebrows, eyelashes and hairline, a flat nasal bridge, ptosis, and a broad oral stoma with thick lips (Figure 16.28). Agenesis of the corpus callosum may be present as well as congenital heart disease, and hypotonia/laxity in early childhood can be pronounced. However, the concept of Coffin-Siris syndrome as a distinct entity is in question and likely to evolve.

*ARID1B* has turned out to be a relatively common gene implicated in LD, accounting for up to 1% of cases in some cohorts. Heterozygous deletions and point mutations may cause the phenotype. To illustrate the difficulties with delineation, not all cases have fifth fingernail abnormalities, and not all with mutations have typical facial features. The gene, which is also designated *KIAA1235*, encodes a protein which forms



**FIGURE 16.26** A child with Wiedemann-Steiner syndrome. Note the broad nasal bridge and mild hypertelorism.



**FIGURE 16.27** A girl with genitopatellar syndrome. **A**, Soft dysmorphic features, especially a broad nasal root. **B** and **C**, the thumbs and great toes are unusually long.



**FIGURE 16.28** **A** and **B**, A toddler and an older child with Coffin-Siris syndrome due to a mutation (in **A**) and deletion (in **B**) of the *ARID1B* gene. Note the broad nasal root, nose, and flat nasal tip, hirsute features, and fleshy ears. **C**, The hirsute back of the child in (**B**). **D** and **E**, the hands of 'A' and 'B' respectively, showing slightly spatulate digits and slightly short fifth fingers with small nails.

a subunit of a complex that remodels chromatin through regulation of gene expression.

### **SETD5-Associated Mental Retardation**

An example of one of the very newly reported (2014) LD disorders is the condition due to mutations in the *SETD5* gene, also designated *KIAA1757*, which is believed to encode a methyltransferase. In common with many of the newly delineated LD conditions, this disorder does not yet have a name other than being known by its gene. Moderate to severe LD occurs together with autistic features and the facial features are subtle but probably recognizable with experience (Figure 16.29). The gene is located at 3p25, and not surprisingly there are overlapping features with the corresponding microdeletion 3p25 syndrome.

### **KCNQ2-Associated Early Infantile Epileptic Encephalopathy**

Heterozygous de novo mutations in *KCNQ2* cause one of the many varieties of early infantile epileptic encephalopathy (EIEE). The group of disorders is characterized by very early onset epilepsy which can be very difficult to bring under control, though sometimes improves over several years. Severe LD accompanies the disorder and is most likely a primary aspect rather than secondary to multiple seizures. Genes such as *SCN1A*, *SCN2A*, *ARX* and *CDKL5* (both X-linked), and *STXBPI*, and many others, are associated with specific subtypes, though they are virtually impossible to distinguish clinically. The term **Ohtahara syndrome** is sometimes used. A child with severe developmental delay and early seizures is shown in Figure 16.30A.



**FIGURE 16.29** A child with a de novo mutation in *SETD5*, giving rise to soft dysmorphic features and significant LD.



**FIGURE 16.30** Two children with early infantile epileptic encephalopathy; **A**, due to a de novo mutation in *KCNQ2*; **B**, due to a de novo frameshift mutation in the X-linked gene *SMC1A* (without features of CdLS).

### SMC1A-Associated EIEE

To conclude this chapter and bring this section full circle, we return to the gene implicated in a rare form of CdLS, i.e. X-linked *SMC1A* (p. 230). It emerged in 2015–16 that novel frameshift mutations can cause a form of EIEE more or less indistinguishable from the others and, notably, *not* accompanied by features of CdLS. An affected child is shown in [Figure 16.30B](#).

### FURTHER READING

Aase, J., 1990. Diagnostic dysmorphology. Plenum, London.

*A detailed text of the art and science of dysmorphology.*

Hanson, J.W., 1997. Human teratology. In: Rimoin, D.L., Connor, J.M., Pyeritz, R.E. (Eds.), Principles and practice of medical genetics, third ed. Churchill Livingstone, New York, pp. 697–724.

*A comprehensive, balanced overview of known and suspected human teratogens.*

Jones, K.L., 2006. Smith's recognizable patterns of human malformation, sixth ed. Saunders, Philadelphia.

*The standard pediatric textbook guide to syndromes.*

Smithells, R.W., Newman, C.G.H., 1992. Recognition of thalidomide defects. *J. Med. Genet.* 29, 716–723.

*A comprehensive account of the spectrum of abnormalities caused by thalidomide.*

Spranger, J., Benirschke, K., Hall, J.G., et al., 1982. Errors of morphogenesis: concepts and terms. Recommendations of an international working group. *J. Pediatr.* 100, 160–165.

*A short article providing a classification and clarification of the terms used to describe birth defects.*

Stevenson, R.E., Hall, J.G., Goodman, R.M., 1993. Human malformations and related anomalies. Oxford University Press, New York.

*The definitive guide, in two volumes, to human malformations.*

Stevenson, R.E., Schwartz, C.E., 2009. X-linked intellectual disability: unique vulnerability of the male genome. *Dev Disabil Res Rev* 15, 361–368.

### ELEMENTS

- 1 Congenital abnormalities are apparent at birth in 1 in 40 of all newborn infants. They account for 20% to 25% of all deaths occurring in the perinatal period and in childhood up to the age of 10 years.
- 2 A single abnormality can be classified as a malformation, a deformation, a dysplasia, or a disruption. Multiple abnormalities can be classified as a sequence, a syndrome, or an association.
- 3 Congenital abnormalities can be caused by chromosome imbalance, single-gene defects, multifactorial inheritance, or non-genetic factors. Many isolated malformations, including isolated congenital heart defects and neural tube defects, show multifactorial inheritance, whereas most dysplasias have a single-gene etiology.
- 4 Many congenital malformations, including cleft lip/palate, congenital heart defects, and neural tube defects, show etiological heterogeneity, so that when counseling it is important to establish whether these malformations are isolated or are associated with other abnormalities.
- 5 Many environmental agents have been shown to have a teratogenic effect with lifelong physical and neurodevelopmental implications, e.g. alcohol; great care should be taken to avoid exposure during pregnancy.
- 6 Learning (or intellectual) disability is a huge part of clinical genetic practice and often part of a syndrome; microarray-CGH and next generation sequencing are enabling great advances to be made in understanding the genetic causes.

## Chromosome Disorders

The development of a reliable technique for chromosome analysis in 1956 soon led to the discovery that several previously described conditions were due to an abnormality in chromosome number. Within 3 years, the causes of Down syndrome (47,XX+21/47,XY+21), Klinefelter syndrome (47,XXY), and Turner syndrome (45,X) had been established. Shortly after, other autosomal trisomy syndromes were recognized, and over the ensuing years many other multiple malformation syndromes were described in which there was loss or gain of chromosome material.

Presently, there are tens of thousands of chromosomal abnormalities registered on laboratory databases and the disciplines of cytogenetics and molecular genetics have merged through the development of microarray comparative genomic hybridization (CGH) technology (pp. 54, 245). When very small genomic imbalances are detected by these techniques we are unsure whether it is appropriate to classify them as ‘chromosome disorders’. Individually, most conditions are very rare, but together they make a major contribution to human morbidity and mortality. Chromosome abnormalities account for a large proportion of spontaneous pregnancy loss and childhood disability, and also contribute to malignancy throughout life as a consequence of acquired translocations and other aberrations.

In [Chapter 3](#), the basic principles of chromosome structure, function, and behavior during cell division were described, together with an account of chromosome abnormalities and how they can arise and be transmitted in families. In this chapter, the medical aspects of chromosome abnormalities, and some of their specific syndromes, are described.

### Incidence of Chromosome Abnormalities

Chromosome abnormalities are present in at least 10% of all spermatozoa and 25% of mature oocytes. Some 15% to 20% of all recognized pregnancies end in spontaneous miscarriage, and many more zygotes and embryos are so abnormal that survival beyond the first few days or weeks after fertilization is not possible. Approximately 50% of all spontaneous miscarriages have a chromosome abnormality ([Table 17.1](#)) and the incidence of chromosomal abnormalities in morphologically normal embryos is approximately 20%. Using high resolution techniques, as many as 80% of embryos generated for in vitro fertilization may have genomic imbalances. Chromosomal anomalies therefore account for the spontaneous loss of a very high proportion of all human conceptions.

Following implantation the incidence of chromosome abnormalities falls rapidly. By birth it has declined to a level of 0.5% to 1%, although the total is higher (5%) in stillborn infants. [Table 17.2](#) lists the incidence figures for chromosome abnormalities based on newborn surveys. It is notable that among the commonly recognized aneuploidy syndromes, there is also

a high proportion of spontaneous pregnancy loss ([Table 17.3](#)). This is illustrated by comparison of the incidence of conditions such as Down syndrome at the time of chorionic villus sampling (11 to 12 weeks), amniocentesis (16 weeks), and term ([Figure 17.1](#)).

### Down Syndrome (Trisomy 21)

This condition derives its name from Dr Langdon Down, who first described it in the Clinical Lecture Reports of the London Hospital in 1866. The chromosomal basis of Down syndrome was not established until 1959 by Lejeune and his colleagues in Paris.

#### Incidence

The overall birth incidence, when adjusted for the increasingly widespread impact of antenatal screening, is approximately 1:1000 in the United Kingdom, which has a national register. In the United States, the birth incidence has been estimated at approximately 1:800. In the United Kingdom, approximately 60% of Down syndrome cases are detected prenatally. There is a strong association between the incidence of Down syndrome and advancing maternal age ([Table 17.4](#)).

#### Clinical Features

These are summarized in [Box 17.1](#). The most common finding in the newborn period is significant hypotonia. Usually the facial characteristics of upward sloping palpebral fissures, small ears, and protruding tongue ([Figures 17.2](#) and [17.3](#)) prompt rapid suspicion of the diagnosis, although this can be delayed in very small or premature babies. Single palmar creases are found in 50% of children with Down syndrome ([Figure 17.4](#)), in contrast to between 2% and 3% of the general population, and congenital cardiac defects in 40% to 45%, the four most common lesions being atrioventricular canal defects, ventricular septal defects, patent ductus arteriosus, and tetralogy of Fallot.

**Table 17.1** Chromosome Abnormalities in Spontaneous Abortions (Percentage Values Relate to Total of Chromosomally Abnormal Abortuses)

Abnormality	Incidence (%)
Trisomy 13	2
Trisomy 16	15
Trisomy 18	3
Trisomy 21	5
Trisomy other	25
Monosomy X	20
Triploidy	15
Tetraploidy	5
Other	10

**Table 17.2** Incidence of Chromosome Abnormalities in the Newborn

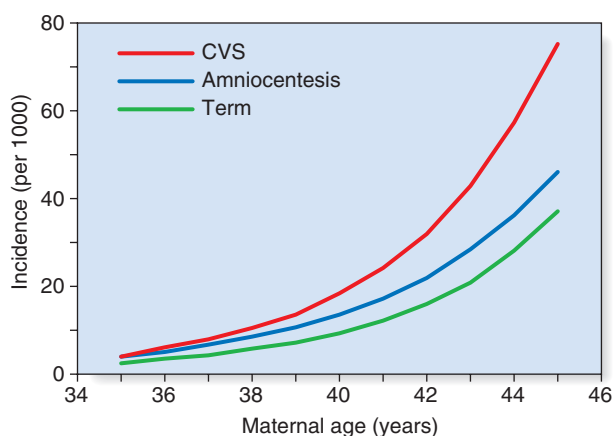
Abnormality	Incidence per 10,000 Births
<b>Autosomes</b>	
Trisomy 13	2
Trisomy 18	3
Trisomy 21	15
<b>Sex Chromosomes</b>	
FEMALE BIRTHS	
45,X	1–2
47,XXX	10
MALE BIRTHS	
47,XXY	10
47,XYY	10
Other unbalanced rearrangements	10
Balanced rearrangements	30
Total	90

**Table 17.3** Spontaneous Pregnancy Loss in Commonly Recognized Aneuploidy Syndromes

Disorder	Proportion Undergoing Spontaneous Pregnancy Loss (%)
Trisomy 13	95
Trisomy 18	95
Trisomy 21	80
Monosomy X	98

### Natural History

Affected children show a broad range of intellectual ability with IQ scores ranging from 25 to 75. The average IQ of young adults is around 40 to 45. Social skills are relatively well-advanced and most children are happy and very affectionate. Adult height is approximately 150 cm. In the absence of a severe cardiac anomaly, which despite modern surgery and



**FIGURE 17.1** Approximate incidence of trisomy 21 at the time of chorionic villus sampling (CVS) (11–12 weeks), amniocentesis (16 weeks), and delivery. (Data from Hook EB, Cross PK, Jackson L, et al 1988 Maternal age-specific rates of 47, 121 and other cytogenetic abnormalities diagnosed in the first trimester of pregnancy in chorionic villus biopsy specimens. *Am J Hum Genet* 42:797–807; and Cuckle HS, Wald NJ, Thompson SG 1987 Estimating a woman's risk of having a pregnancy associated with Down syndrome using her age and serum alpha-fetoprotein level. *Br J Obstet Gynaecol* 94:387–402.)

**Table 17.4** Incidence of Down Syndrome in Relation to Maternal Age

Maternal Age at Delivery (Years)	Incidence of Down Syndrome
20	1 in 1500
25	1 in 1350
30	1 in 900
35	1 in 400
36	1 in 300
37	1 in 250
38	1 in 200
39	1 in 150
40	1 in 100
41	1 in 85
42	1 in 65
43	1 in 50
44	1 in 40
45	1 in 30

Adapted from Cuckle HS, Wald NJ, Thompson SG 1987 Estimating a woman's risk of having a pregnancy associated with Down syndrome using her age and serum alpha-fetoprotein level. *Br J Obstet Gynaecol* 94:387–402.

intensive care leads to early death in 15% to 20% of cases, average life expectancy is 50 to 60 years. Overall, about 90% of live-born individuals with Down syndrome reach 20 years of age. Most affected adults develop Alzheimer disease in later life, possibly because of a gene dosage effect—the amyloid precursor protein gene is on chromosome 21. This gene is known to be implicated in some familial cases of Alzheimer disease (p. 142).

### Chromosome Findings

These are listed in Table 17.5. In cases resulting from trisomy 21, the additional chromosome is maternal in origin in more than 90% of cases, and DNA studies have shown that this arises most commonly as a result of non-disjunction in maternal meiosis I (p. 30). Robertsonian translocations (p. 36) account for approximately 4% of all cases, in roughly one-third of which a parent is found to be a carrier. Children with mosaicism are often less severely affected than those with the full syndrome.

Efforts have been made to correlate the various clinical features in trisomy Down syndrome with specific regions of chromosome 21, by studying children with partial trisomy for different regions.

### Box 17.1 Common Findings in Down Syndrome

#### Newborn period

Hypotonia, sleepy, excess nuchal skin

#### Craniofacial

Brachycephaly, epicanthic folds, protruding tongue, small ears, upward sloping palpebral fissures

#### Limbs

Single palmar crease, small middle phalanx of fifth finger, wide gap between first and second toes

#### Cardiac

Atrial and ventricular septal defects, common atrioventricular canal, patent ductus arteriosus

#### Other

Anal atresia, duodenal atresia, Hirschsprung disease, short stature, strabismus

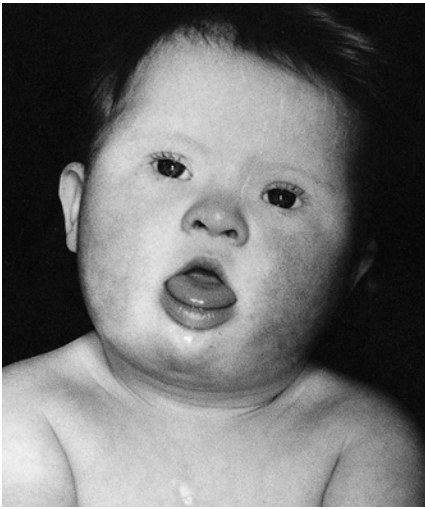


FIGURE 17.2 A child with Down syndrome.



FIGURE 17.3 Close-up view of the eyes and nasal bridge of a child with Down syndrome showing upward sloping palpebral fissures, Brushfield spots, and bilateral epicanthic folds.

There is some support for a Down syndrome 'critical region' at the distal end of the long arm (21q22), because children with trisomy for this region alone usually have typical Down syndrome facial features. Chromosome 21 is a 'gene-poor' chromosome with a high ratio of AT to GC sequences (p. 52). At present the only reasonably well-established genotype-phenotype correlation in trisomy 21 is the high incidence of Alzheimer disease.



FIGURE 17.4 The hands of an adult with Down syndrome. Note the single palmar crease in the left hand plus bilateral short curved fifth fingers (clinodactyly).

**Table 17.5** Chromosome Abnormalities in Down Syndrome

Abnormality	Frequency (%)
Trisomy	95
Translocation	4
Mosaicism	1

### Recurrence Risk

For straightforward trisomy 21, the recurrence risk is related to maternal age (variable) and the simple fact that trisomy has already occurred (approximately 1%). The combined recurrence risk is usually between 1:200 and 1:100. In translocation cases, similar figures apply if neither parent is a carrier. In familial translocation cases, the recurrence risks vary from 1% to 3% for male carriers and up to 10% to 15% for female carriers, with the exception of very rare carriers of a 21q21q translocation, for whom the recurrence risk is 100% (p. 37).

Prenatal diagnosis can be offered based on analysis of chorionic villi or cultured amniotic cells. Prenatal screening programs have been introduced based on the so-called triple or quadruple tests of maternal serum at 16 weeks' gestation (p. 308).

### Patau Syndrome (Trisomy 13) and Edwards Syndrome (Trisomy 18)

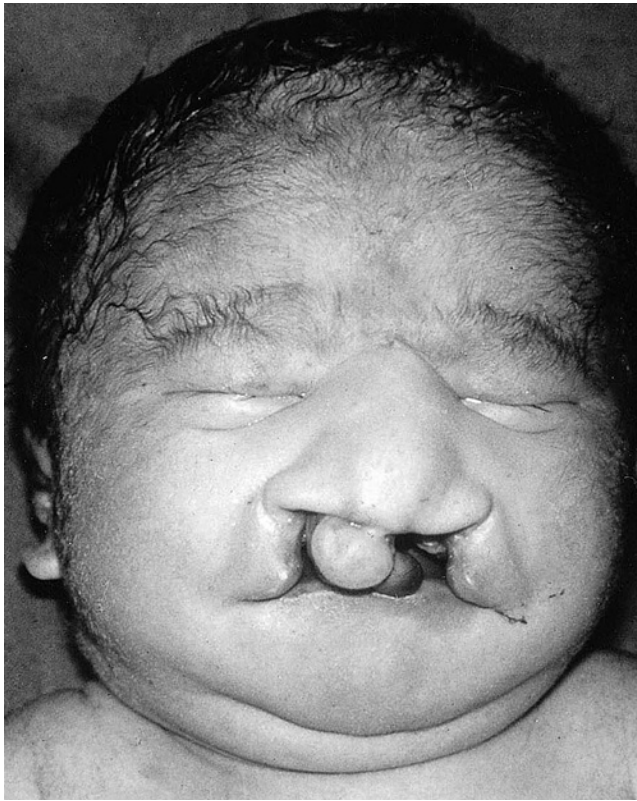
These very severe conditions were first described in 1960 and share some features in common (Figures 17.5 and 17.6). The incidence of Edwards syndrome is approximately 1:6000, Patau syndrome two or three times less frequent, and prognosis is very poor, with most infants dying during the first days or weeks of life, though most cases are now detected prenatally with intrauterine growth retardation and some abnormal fetal ultrasound features, often leading to termination. In the unusual event of longer term survival, there are severe learning difficulties. Cardiac abnormalities occur in at least 90% of cases. The facial features in trisomy 13 are characteristic, often with clefting, and affected infants frequently have scalp defects, exomphalos and post-axial polydactyly. Trisomy 18 is characterized by poor growth, microcephaly, micrognathia, clenched hands and 'rocker bottom' feet.

Chromosome analysis usually reveals straightforward trisomy. Both disorders occur more frequently with advanced maternal age, the additional chromosome being of maternal origin (see Table 3.4, p. 34). Approximately 10% of cases are caused by mosaicism or unbalanced rearrangements, particularly Robertsonian translocations in Patau syndrome.

### Triploidy

Triploidy (69,XXX, 69,XXY, 69,XYY) is a relatively common finding in material cultured from spontaneous abortions, but is seen only rarely in a live-born infant. Such a child almost always shows severe intrauterine growth retardation with relative preservation of head growth at the expense of a small narrow trunk. Syndactyly involving the third and fourth fingers and/or the second and third toes is a common finding. Cases of triploidy resulting from a double paternal contribution usually miscarry in early to mid-pregnancy and are associated with partial hydatidiform changes in the placenta (p. 121). Cases with a double maternal contribution survive for longer but rarely beyond the early neonatal period.





**FIGURE 17.5** Facial view of a child with trisomy 13 showing severe bilateral cleft lip and palate.



**FIGURE 17.6** A baby with trisomy 18. Note the prominent occiput and tightly clenched hands.

### Hypomelanosis of Ito

Several children with mosaicism for diploidy/triploidy have been identified. These can demonstrate the clinical picture seen in full triploidy but in a milder form. An alternative presentation occurs as the condition known as hypomelanosis of Ito. In this curious disorder, the skin shows alternating patterns of normally pigmented and depigmented streaks that correspond to the embryological developmental lines of the skin known as Blaschko lines ([Figure 17.7](#)). Most children with hypomelanosis of Ito have moderate learning difficulties and convulsions that can be particularly difficult to treat. There is increasing evidence that this clinical picture represents a non-specific embryological response to cell or tissue mosaicism.

A similar pattern of skin pigmentation is sometimes seen in women with one of the rare X-linked dominant disorders ([p. 73](#)) with skin involvement, such as incontinentia pigmenti (see [Figure 6.18](#), [p. 74](#)). Such women can be considered as being mosaic, as some cells express the normal gene, whereas others express only the mutant gene.

### Disorders of the Sex Chromosomes

#### Klinefelter Syndrome (47,XXY)

First described clinically in 1942, this relatively common condition with an incidence of 1:1000 male live births was shown in 1959 to be due to the presence of an additional X chromosome.



**FIGURE 17.7** Mosaic pattern of skin pigmentation on the arm of a child with hypomelanosis of Ito. (Reproduced with permission from Jenkins D, Martin K, Young ID 1993 *Hypomelanosis of Ito associated with mosaicism for trisomy 7 and apparent 'pseudomosaicism' at amniocentesis*. *J Med Genet* 1993;30:783–784.)

### Clinical Features

In childhood the presentation may be with clumsiness or mild learning difficulties, particularly in relation to verbal skills. The overall verbal IQ is reduced by 10 to 20 points below unaffected siblings and controls, and children can be rather self-obsessed in their behavior. Adults tend to be slightly taller than average with long lower limbs. Approximately 30% show moderately severe gynecomastia (breast enlargement) and all are infertile because of the absence of sperm in their semen (*azoospermia*), with small, soft testes. Fertility has been achieved for a small number of affected males using the techniques of testicular sperm aspiration and intracytoplasmic sperm injection. There is an increased incidence of leg ulcers, osteoporosis, and carcinoma of the breast in adult life. Treatment with testosterone from puberty onward is beneficial for the development of secondary sexual characteristics and the long-term prevention of osteoporosis.

### Chromosome Findings

Usually the karyotype shows an additional X chromosome. Molecular studies have shown that there is a roughly equal chance that this will have been inherited from the mother or from the father. The maternally derived cases are associated with advanced maternal age. A small proportion of cases show mosaicism (e.g., 46,XY/47,XXY). Rarely, a male with more than two X chromosomes can be encountered, for example 48,XXXXY or 49,XXXXXY. These individuals are usually quite severely retarded and also share physical characteristics with Klinefelter men, often to a more marked degree.

### Turner Syndrome (45,X)

This condition was first described clinically in 1938. The absence of a Barr body, consistent with the presence of only one X chromosome, was noted in 1954 and cytogenetic confirmation was forthcoming in 1959. Although common at conception and in spontaneous abortions (see Table 17.1), the incidence in live-born female infants is low, with estimates ranging from 1:5000 to 1:10,000.

### Clinical Features

Presentation can be at any time from pregnancy to adult life. Increasingly, Turner syndrome is being detected during the second trimester as a result of routine ultrasonography, showing either generalized edema (hydrops) or swelling localized to the neck (nuchal cyst or thickened nuchal pad) (Figure 17.8). At birth many babies with Turner syndrome look entirely normal. Others show the residue of intrauterine edema with puffy extremities (Figure 17.9) and neck webbing. Other findings may include a low posterior hairline, increased carrying angles at the elbows, short fourth metacarpals, widely spaced nipples, and coarctation of the aorta, which is present in 15% of cases.

Intelligence in Turner syndrome is within the normal range. However, studies have shown some differences in social cognition and higher order executive function skills according to whether the X chromosome was paternal or maternal in origin. Those with a paternal X scored better, from which the existence of a locus for social cognition on the X chromosome can be postulated. If such a locus is not expressed from the maternal X, this could provide at least part of the explanation for the excess difficulty with language and social skills observed in 46,XY males, as their X is always maternal in origin.



**FIGURE 17.8** Ultrasonographic scan at 18 weeks' gestation showing hydrops fetalis. Note the halo of fluid surrounding the fetus. (Courtesy Dr. D. Rose, City Hospital, Nottingham, UK.)

The two main medical problems are short stature and ovarian failure. The short stature becomes apparent by mid-childhood, and without growth hormone treatment the average adult height is 145 cm. This short stature is due, at least in part, to haploinsufficiency for the *SHOX* gene, which is located in the pseudoautosomal region (p. 122). Ovarian failure commences during the second half of intrauterine life and almost invariably leads to primary amenorrhea and infertility. Estrogen



**FIGURE 17.9** The foot of an infant with Turner syndrome showing edema and small nails.

**Table 17.6** Chromosome Findings in Turner Syndrome

Karyotype	Frequency (%)
Monosomy X: 45,X	50
Mosaicism (e.g., 45,X/46,XX)	20
Isochromosome: 46,X,i(Xq)	15
Ring: 46,X,r(X)	5
Deletion: 46,X,del(Xp)	5
Other	5

replacement therapy should be initiated at adolescence for the development of secondary sexual characteristics and long-term prevention of osteoporosis. In vitro fertilization using donor eggs offers the prospect of pregnancy for women with Turner syndrome.

### Chromosome Findings

These are summarized in [Table 17.6](#). The most common finding is 45,X (sometimes erroneously referred to as 45,XO). In 80% of cases, it arises through loss of a sex chromosome (X or Y) at *paternal* meiosis. In a significant proportion of cases, there is chromosome mosaicism and those with a normal cell line (46,XX) have a chance of being fertile. Some cases with a 46,XY cell line are phenotypically male, and all cases with some Y-chromosome material in their second cell line must be investigated for possible gonadal dysgenesis—intracellular male gonads can occasionally become malignant and require surgical removal.

### XXX Females

Birth surveys have shown that approximately 0.1% of all females have a 47,XXX karyotype. These women usually have no obvious physical abnormalities, though head circumference is usually in the lower centiles, but can show a mild reduction of between 10 and 20 points in intellectual skills and sometimes quite oppositional behavior. This is rarely of sufficient severity to require special education. Studies have shown that the additional X chromosome is of *maternal* origin in 95% of cases and usually arises from an error in meiosis I. Adults are usually fertile and have children with normal karyotypes.

As with males who have more than two X chromosomes, women with more than three X chromosomes show a high incidence of learning difficulties, the severity being directly related to the number of X chromosomes.

### The 46,Xr(X) Phenotype

A 46,Xr(X) karyotype—a ring chromosome X—is found in some women with typical features of Turner syndrome. This is consistent with the ring lacking X sequences, which are normally not inactivated and which are needed for a normal phenotype. Curiously, a few 46,Xr(X) women have congenital abnormalities and show intellectual impairment. In these women it has been shown that *XIST* is not expressed on the ring X, so their relatively severe phenotype is likely to be caused by functional disomy for genes present on their ring X chromosome.

### XYY Males

This condition shows an incidence of about 1:1000 in males in newborn surveys but is found in 2% to 3% of males who are in institutions because of learning difficulties or antisocial

criminal behavior. However, it is important to stress that most 47,XYY men have neither learning difficulty nor a criminal record, although they can show emotional immaturity and impulsive behavior. Fertility is normal.

Physical appearance is normal and stature is usually above average. Intelligence is mildly impaired, with an overall IQ score of 10 to 20 points below a control sample. The additional Y chromosome must arise either as a result of non-disjunction in *paternal* meiosis II or as a post-zygotic event.

### Fragile X Syndrome

This condition, which could equally well be classified as a single gene disorder rather than a chromosome abnormality, has the unique distinction of being one of the most common inherited causes of learning difficulties and the first disorder in which a dynamic mutation (triplet repeat expansion) was identified ([p. 18](#)) in 1991. It affects approximately 1:5000 males and accounts for 4% to 8% of all males with learning difficulties. As such it would fit equally well in [Chapter 16](#). Martin and Bell described the condition in the 1940s before the chromosome era, and hence it has also been known as Martin-Bell syndrome. The chromosomal abnormality was first described in 1969 but the significance not fully realized until 1977.

### Clinical Features

Older boys and adult males usually have a recognizable facial appearance with high forehead, large ears, long face, and prominent jaw ([Figure 17.10A,B](#)). After puberty most affected males have large testes (macro-orchidism). There may also be evidence of connective tissue weakness, with hyperextensible joints, stretch marks on the skin (striae) and mitral valve prolapse. The learning difficulties are moderate to severe and many show autistic features and/or hyperactive behavior. Speech tends to be halting and repetitive. Female carriers can show some of the facial features, and approximately 50% of women with the full mutation show mild-to-moderate learning difficulties.

### The Fragile X Chromosome

The fragile X syndrome takes its name from the appearance of the X chromosome, which shows a *fragile site* close to the telomere at the end of the long arm at Xq27.3 ([Figure 17.11](#)). A fragile site is a non-staining gap usually involving both chromatids at a point at which the chromosome is liable to break. In this condition, detection of the fragile site involves the use of special culture techniques such as folate or thymidine depletion, which can result in the fragile site being detectable in up to 50% of cells from affected males. Demonstration of the fragile site in female carriers is much more difficult and cytogenetic studies alone are not a reliable means of carrier detection because, although a positive result confirms carrier status, the absence of the fragile site does not exclude a woman from being a carrier. Diagnosis is now undertaken using molecular techniques.

### The Molecular Defect

The fragile X locus is known as *FRAXA* and the mutation consists of an increase in the size of a region in the 5'-untranslated region of the fragile X learning difficulties (*FMR-1*) gene. This region contains a long CGG trinucleotide repeat sequence. In the DNA of a normal person, there are between 10 and 50 copies of this triplet repeat and these are inherited in a stable fashion. However, a small increase to between 59 and 200



**FIGURE 17.10** **A**, A family affected by fragile X syndrome. Two sisters, both carriers of a small *FRAXA* mutation inherited from their father, have had affected sons with different degrees of learning difficulty. **B**, A young boy with typical facial features of fragile X syndrome, showing the long face, long ears, and slightly large head.

renders this repeat sequence unstable, a condition in which it is referred to as a **premutation**. Alleles of 51 to 58 are referred to as **intermediate**.

A man who carries a premutation is known as a 'normal transmitting male', although it has been recognized that these premutation carriers are at increased risk of a late-onset neurological condition named 'fragile X tremor/ataxia syndrome' (FXTAS). All of his daughters will inherit the premutation and have normal intelligence, but they are also at small risk of FXTAS in later years. When they have sons, there is a significant risk that the premutation will undergo a further increase in size during meiosis, and if this exceeds 200 CGG triplets, it becomes a full mutation.

The full mutation is unstable not only during female meiosis but also in somatic mitotic divisions. Consequently, in an affected male gel electrophoresis shows a 'smear' of DNA consisting of a range of different-sized alleles rather than a single band (Figure 17.12). Note that a normal allele and premutation can be identified by polymerase chain reaction (PCR), whereas Southern blotting is necessary to detect full mutations as the long CGG expansion is often refractory to PCR amplification. At the molecular level, a full mutation suppresses transcription of the *FMR-1* gene by hypermethylation, and this in turn is thought to be responsible for the clinical features seen in males, and in some females with a large expansion (Table 17.7). The *FMR-1* gene contains 17 exons encoding a cytoplasmic protein

that plays a crucial role in the development and function of cerebral neurons. The FMR-1 protein can be detected in blood using specific monoclonal antibodies.

Another fragile site adjacent to *FRAXA* has been identified at Xq28. This is known as *FRAXE*. The expansion mutations at *FRAXE* also involve CGG triplet repeats and occur much less frequently than *FRAXA* mutations. Some males with these mutations have mild learning difficulties, whereas others are just as severely affected as men with *FRAXA*. *FRAXE* may show up as a fragile site cytogenetically but the PCR test is separate. A third fragile site, *FRAXF*, has been identified close to *FRAXA* and *FRAXE*. This does not seem to cause any clinical abnormality.

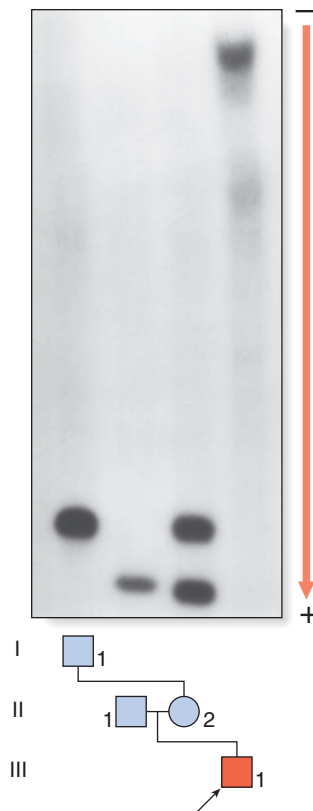
### Genetic Counseling and the Fragile X Syndrome

This common cause of learning difficulties presents a major counseling problem. Inheritance can be regarded as modified or atypical X-linked. All of the daughters of a normal transmitting male will carry the premutation. Their male offspring are at risk of inheriting either the premutation or a full mutation. This risk is dependent on the size of the premutation in the mother, with mutations greater than 100 CGG repeats usually increasing in size to become full mutations.

For a woman who carries a full mutation there is a 50% risk that each of her sons will be affected with the full syndrome and that each of her daughters will inherit the full mutation.



**FIGURE 17.11** X chromosome from several males with fragile X syndrome. (Courtesy Ashley Wilkinson, City Hospital, Nottingham, UK.)



**FIGURE 17.12** Southern blot of DNA from a family showing expansion of the CCG triplet repeat being passed from a normal transmitting male through his obligate carrier daughter to her son with fragile X learning difficulties. (Courtesy Dr. G. Taylor, St. James's Hospital, Leeds, UK.)

Because approximately 50% of females with the full mutation have mild learning difficulties, the risk that a female carrier of a full mutation will have a daughter with learning difficulties equals  $\frac{1}{2} \times \frac{1}{2}$  (i.e.,  $\frac{1}{4}$ ). Prenatal diagnosis can be offered based on analysis of DNA from chorionic villi, but in the event of a female fetus with a full mutation an accurate prediction of intellectual disability cannot be made.

The fragile X syndrome is a condition for which population screening could be offered, either among selected high-risk groups such as males with learning difficulties or on a widespread general population basis. Such programs will have to surmount major ethical, financial, and logistical concerns if they are to achieve widespread acceptance (p. 146).



**FIGURE 17.13** A child with deletion 4p syndrome; Wolf-Hirschhorn syndrome.

## 'Classic' Chromosome Deletion Syndromes

### Deletion 4p and 5p Syndromes

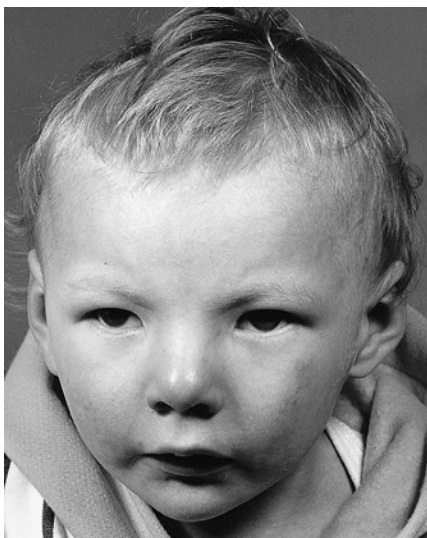
Microscopically visible deletions of the terminal portions of chromosomes 4 and 5 cause the Wolf-Hirschhorn (4p-) (Figure 17.13) and cri-du-chat (5p-) (Figure 17.14) syndromes, respectively. In both conditions severe learning difficulties are usual, often with failure to thrive. However, there is considerable variability, particularly in Wolf-Hirschhorn syndrome, and no clear correlation of the phenotype with the precise loss of chromosomal material. Cri-du-chat syndrome derives its name from the characteristic cat-like cry of affected neonates—a consequence of underdevelopment of the larynx. Both conditions are rare, with estimated incidences of approximately 1:50,000 births. Not all cases have cytogenetically visible chromosome deletions and microarray-CGH (pp. 54, 245) will identify the smaller deletions.

### Wilms Tumor/WAGR

Some children with the rare renal embryonal neoplasm known as Wilms tumor (or hypernephroma) also have aniridia, genitourinary abnormalities, and retardation of growth and development. This combination is referred to as the WAGR syndrome. Chromosome analysis in these children often reveals an interstitial deletion of 11p13 (Figure 17.15). The deletion

**Table 17.7** Fragile X Syndrome: Genotype-Phenotype Correlations

Number of Triplet Repeats (Normal Range 10–50)	Fragile Site	Intelligence Detectable
<b>Males</b>		
51–58 (intermediate alleles)		
59–200 (premutation)	No	Normal (normal transmitting male)
200–2000 (full mutation)	Yes (in up to 50% of cells)	Moderate-to-severe learning difficulties
<b>Females</b>		
51–58 (intermediate alleles)		
59–200 (premutation)	No	Normal
200–2000 (full mutation)	Yes (usually <10% of cells)	50% normal, 50% mild learning difficulties



**FIGURE 17.14** Facial view of a 2-year-old boy with cri-du-chat syndrome.

genes include *PAX6*, which is responsible for the aniridia (Figure 17.16). Confirmation is made by FISH or array-CGH analysis (or direct gene mutation analysis in cases of pure aniridia). Loss of the *WT1* gene causes the development of Wilms tumor (see also p. 183). Knowing this, it can now be predicted whether a newly diagnosed child with deletion 11p13 is at high risk of developing a Wilms tumor, using a separate analysis at the *WT1* locus. It is important to note, however, that the genetics of Wilms tumor is complex, with other loci sometimes involved.

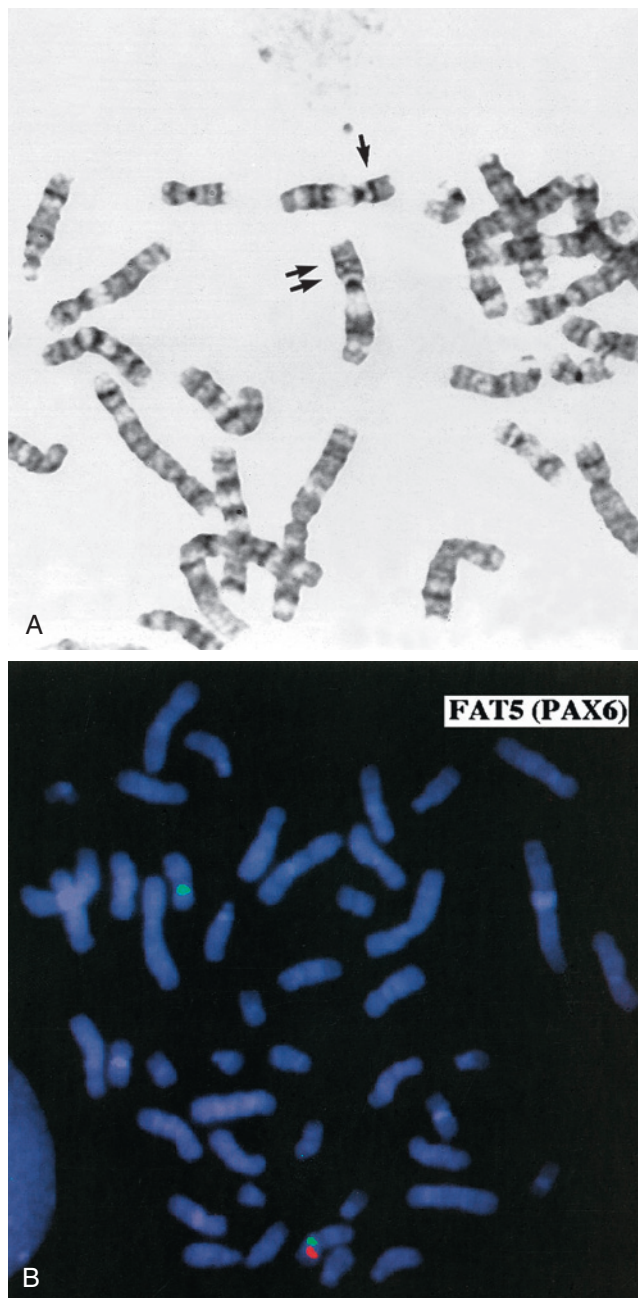
### Angelman and Prader-Willi Syndromes

These two conditions have special place in medical genetics as paradigms for genomic imprinting. Children with Angelman syndrome (see Figure 6.24, p. 78) have inappropriate laughter, convulsions, poor coordination (ataxia), and severe learning difficulties. Children with Prader-Willi syndrome (see Figure 6.22, p. 78) are very hypotonic with poor feeding in infancy, and later develop hyperphagia and obesity, with mild-to-moderate learning difficulties. A large proportion of children with these disorders have a microdeletion involving 15q11-13, always the *paternally* derived chromosome 15 in Prader-Willi syndrome. In contrast, a deletion occurring at the same region on the *maternally* inherited chromosome 15 causes Angelman syndrome. Non-deletion cases also exist and are often due to uniparental disomy (p. 77), with both number 15 chromosomes being *paternal* in origin in Angelman syndrome, and *maternal* in origin in Prader-Willi syndrome. These parent-of-origin effects are explained by imprinting (see Figure 6.23, p. 77).

### Contiguous Gene Syndromes

Through high-resolution prometaphase banding (p. 26) and FISH (p. 27), several previously unexplained syndromes were shown to be due to submicroscopic or *micro*-deletions, and are now detected using microarray-CGH. Some microdeletions involve loss of only a few genes at closely adjacent loci, resulting in **contiguous gene syndromes**. For example, several boys with Duchenne muscular dystrophy (DMD) have been described who also have other X-linked disorders, such as retinitis pigmentosa and glycerol kinase deficiency. The loci for these

disorders are very close to the DMD locus on Xp21. Many, even most, chromosome microdeletions give rise to contiguous gene syndromes because in general, the larger the deletion the more likely it is that affected individuals will have multiple medical and developmental problems. Examples of well-known microdeletion syndromes are given in Table 17.8, all of them relatively rare.



**FIGURE 17.15** **A**, Metaphase spread showing the number 11 chromosomes (*double arrows*). The chromosome indicated by the *single arrow* has an interstitial deletion in the short arm. See Figures 17.11 and 17.12. (Courtesy Meg Heath, City Hospital, Nottingham, UK.) **B**, FISH showing failure of a *PAX6* locus specific probe (*red*) to hybridize to the deleted number 11 chromosome shown in (**A**) from a child with WAGR syndrome. The *green* probe acts as a marker for the centromere of each number 11 chromosome. (Courtesy Dr. John Crolla, Salisbury and Dr. Veronica van Heyningen, Edinburgh, UK.)



**FIGURE 17.16** A baby with deletion 11p13 presenting with aniridia on routine neonatal examination.

### Deletion Xp22.3

As with the rare example already described in relation to Xp21, a microdeletion at Xp22.3 is a classic contiguous gene syndrome. The locus incorporates X-linked recessive chondrodysplasia punctata (aryl sulfatase-E, *ARSE*, gene), mental retardation (*VCX-A* gene), ichthyosis (steroid sulfatase, *STS*, gene) and Kallmann syndrome (*KAL1* gene). Short stature also usually occurs due to loss of the short stature homeobox-containing gene (*SHOX*), which on its own when mutated gives rise to Leri-Weill dyschondrosteosis (p. 122). Depending on the size and extent of the deletion, therefore, individuals may present variably with short stature, a flat face and small nose with a flat nasal tip, short digits, dry skin and hair, hypogonadotropic hypogonadism, anosmia, and learning disability.

### Retinoblastoma

It was originally observed that approximately 5% of children presenting with retinoblastoma had other abnormalities, including learning difficulties. In some of these, a constitutional interstitial deletion of a region of chromosome 13q was identified. The smallest region of overlap was 13q14, which was subsequently shown to be the position of the locus for the

autosomal dominant form of retinoblastoma due to mutations in the *RBI* gene (p. 182).

## Microarray-CGH

The 1990s witnessed the development of FISH-based analysis of all chromosome telomeres using subtelomeric probes. This led to the diagnosis of some cases of learning difficulty/dysmorphic patients, not detected by multiplex ligation-dependent probe amplification (p. 60). From around 2005 this has been rapidly superseded by extensive microarray-CGH testing (p. 54) and a significant number of new microdeletion (and to a lesser extent microduplication) syndromes have emerged. At high resolution, this new technology is yielding significant results in about 20% of cases of well selected, previously unknown dysmorphic patients with developmental delay/learning disability. This compares to a positive pick-up rate of 4% to 5% from standard karyotyping on patients considered likely to have a chromosome disorder. Examples of these new and emerging syndromes are shown in the following section.

### Microdeletion Syndromes: 'Old' and 'New'

#### DiGeorge/Sedláčková/Velocardiofacial Syndrome

DiGeorge syndrome affects approximately 1:4000 births, is usually sporadic, and is characterized by heart malformations (particularly those involving the cardiac outflow tract), thymic and parathyroid hypoplasia, cleft palate and typical facies. The molecular defect is a 3-Mb microdeletion on chromosome 22 (22q11.2). Dr Eva Sedláčková from Prague reported a large series of children with a congenitally short palate in 1955, 10 years earlier than DiGeorge, and these patients clearly had the same condition. A similar phenotype was described by Shprintzen and referred to as velocardiofacial syndrome. Because of the confusion of eponyms and other terms given to this condition over the years, 'deletion 22q11 syndrome' now has the most widespread acceptance (at the molecular level the deleted DNA segment is still called the DiGeorge Critical Region). Figure 17.17 shows individuals with deletion 22q11.2 at different ages. Because it is the most common of the microdeletion syndromes, it has been intensely researched. It is variable and many affected individuals are able to reproduce, so the condition follows autosomal dominant inheritance in some families. The 3 Mb deletion occurs because this region is flanked by two identical sequences of DNA, known as low-copy repeats (LCRs), of the type that occur frequently throughout the genome. At meiosis the chromosomes can be 'confused' when they align, such that the downstream DNA sequence aligns with the upstream. If recombination occurs between these two flanking regions, a deletion of 3 Mb results on one chromosome 22. It is possible that the phenotypic features may be due largely to haploinsufficiency for the *TBX1* gene that lies within the region.

Those diagnosed should be investigated for cardiac malformations, calcium and parathyroid status, immune function, and renal anomalies. About half have short stature and a small proportion of these have partial growth hormone deficiency. Approximately 25% have schizophrenia-like episodes in adult life.

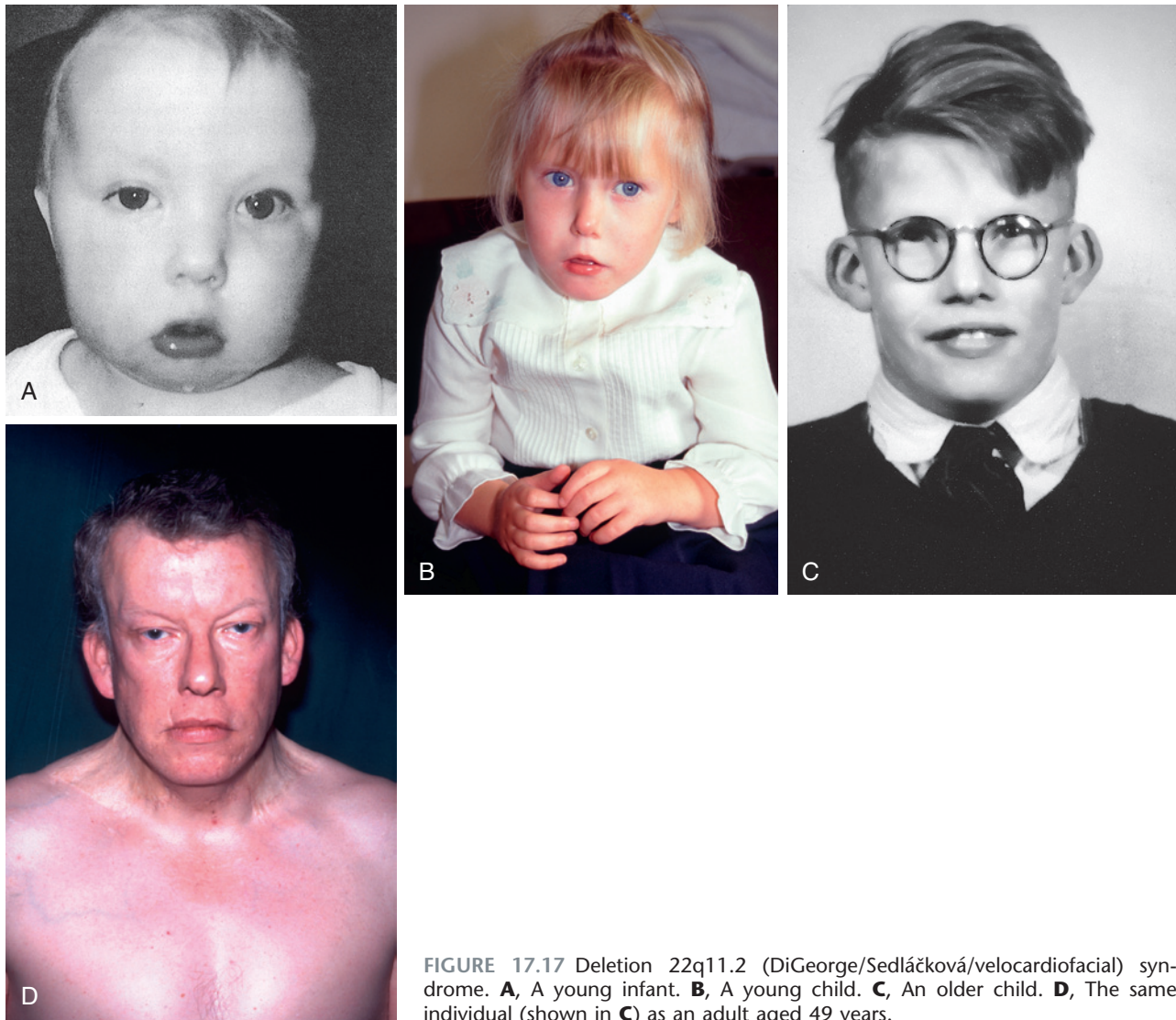
#### Duplication 22q11.2

The misaligned pairing at meiosis of the LCRs that flank the 3 Mb region at 22q11.2 that causes DiGeorge syndrome, predicts that gametes *duplicated* for this DNA segment would

**Table 17.8** Well Known Microdeletion Syndromes

Syndrome	Chromosome
Deletion 1p36	1p36
Williams	7q11.23
Langer-Giedion	8q24.11
Kleefstra	9q34.3
WAGR	11p13
Angelman	15q11.2
Prader-Willi	15q11.2
Rubinstein-Taybi	16p13.3
Miller-Dieker	17p13.3
Smith-Magenis	17p11.2
Koolen-De Vries	17q21.31
DiGeorge/Sedláčková/velocardiofacial	22q11.2

WAGR, Wilms tumor, aniridia, genitourinary malformations, and retardation of growth and development.



**FIGURE 17.17** Deletion 22q11.2 (DiGeorge/Sedláčková/velocardiofacial) syndrome. **A**, A young infant. **B**, A young child. **C**, An older child. **D**, The same individual (shown in **C**) as an adult aged 49 years.

be present in equal numbers. However, duplication 22q11.2 syndrome is encountered somewhat less often in clinical practice than its deletion counterpart, suggesting that it might be subclinical in its effects.

Patients that are seen demonstrate considerable variability with some bearing passing similarity to the *deletion* 22q11.2 phenotype. The problems range from isolated mild learning difficulties to multiple abnormalities with non-specific dysmorphic features, occasional congenital heart disease, cleft palate, hearing loss, and postnatal growth deficiency. [Figure 17.18](#) shows an affected patient.

### Williams Syndrome

Williams syndrome occurs because of a microdeletion at chromosome 7q11 and diagnosis can be confirmed by microarray-CGH or FISH. The clinical phenotype was first reported by Williams in 1961 and later expanded by Beuren (hence, sometimes, Williams-Beuren syndrome). Hypocalcemia is a variable feature in childhood and sometimes persists, whilst supravalvular aortic stenosis (SVAS) and peripheral pulmonary artery stenosis are congenital abnormalities of the great vessels.



**FIGURE 17.18** A patient with duplication 22q11.2. The features are variable and not as recognizable as in deletion 22q11.2, and it is diagnosed less often.



Haploinsufficiency at 7q11 leads to loss of one copy of the gene that encodes elastin, a component of connective tissue. This is probably the key factor causing SVAS and the vascular problems that are more common in later life. Patients with mutations in elastin have a variety of congenital heart defects, sometimes complex and severe. Williams syndrome individuals have a characteristic appearance (Figure 17.19) with mild short stature, a full lower lip, and sloping shoulders. Equally characteristic is their behavior. They are typically very outgoing in childhood—having a ‘cocktail party manner’—but become withdrawn and sensitive as adults. All are intellectually impaired to the extent that they cannot lead independent lives, and the majority do not reproduce, although parent-child transmission has been reported.

### Smith-Magenis Syndrome

This microdeletion syndrome is due to loss of chromosome material at 17p.11.2, often visible cytogenetically. As with DiGeorge syndrome, the deletion mechanism in many cases involves homologous recombination between flanking LCRs.

The physical characteristics are not highly distinctive (Figure 17.20), but congenital heart disease occurs in one-third, scoliosis develops in late childhood in more than half, and hearing impairment in about two-thirds. The syndrome is most likely to be recognized by the behavioral characteristics: as children, patients exhibit self-harming (head-banging, pulling out nails, and inserting objects into orifices), a persistently disturbed sleep pattern, and characteristic ‘self-hugging’. Learning disability is the norm and usually moderate-severe. The sleep pattern can often be managed by judicious use of melatonin. The same phenotype may be due to a mutation in the *RAI1* gene, which is located within the deleted segment.

### Deletion 1p36 Syndrome

This microdeletion syndrome emerged through improved cytogenetic techniques and the use of FISH in the 1990s. In keeping with the modern approach to nomenclature, deletion 1p36 syndrome has no eponym. The features are hypotonia, microcephaly, growth delay, severe learning difficulties, epilepsy (including infantile spasms), characteristically straight



**FIGURE 17.19** A person with Williams syndrome as a baby (A), a young child (B), an older child (C), and in his early forties (D). The eyes of another patient showing the stellate irides (E).



**FIGURE 17.20** A young person with Smith-Magenis syndrome; the facial features are not highly distinctive, but the philtrum is usually short. As babies, chromosome studies are often requested because the possibility of Down syndrome is raised.

eyebrows with slightly deep-set eyes, and midface hypoplasia (Figure 17.21). Some cases develop dilated cardiomyopathy.

### Deletion 9q34 Syndrome

Another of the relatively new microdeletion syndromes, this was first reported as a condition featuring significant learning difficulties, hypotonia, obesity, brachycephaly, arched eyebrows, synophrys, anteverted nostrils, prognathism, sleep disturbances, and behavioral problems. Many patients have severe speech delay and not all manifest obesity. The case pictured here (Figure 17.22) bears a passing resemblance to Angelman syndrome. As with some of the other microdeletion syndromes, some patients with the phenotypic features but no microdeletion have been shown to have mutations in the euchromatin histone methyl transferase 1 (*EHMT1*) gene,



**FIGURE 17.21** A child with deletion 1p36 syndrome; very straight eyebrows, epilepsy, and learning difficulties.



**FIGURE 17.22** A child with deletion 9q34 syndrome. She has arched eyebrows, narrow upslanting palpebral fissures, brachycephaly, prognathism, and severe learning difficulties. She was initially investigated for possible Angelman syndrome.

which lies within the region. The syndrome might therefore be mainly due to haploinsufficiency for this gene.

### Deletion 17q21.31 Syndrome

This relatively new condition, sometimes referred to as Koolen syndrome, has a prevalence of approximately 1:16,000 and is probably significantly underdiagnosed. The main features are severe developmental delay, hypotonia, and characteristic facial dysmorphisms including a long face with a high forehead and tubular or pear-shaped nose, a bulbous nasal tip, large ears, and everted lower lip (Figure 17.23). Individuals tend to be friendly. Other clinically important features include epilepsy, heart defects, kidney anomalies, and long slender fingers.

### Deletion 1q21.1 Syndrome

This condition was first identified in three individuals from a cohort of 505 with congenital heart disease. The phenotype is broad and includes mild-moderate mental retardation, small head size, growth retardation, heart defects, cataracts, hand deformities and skeletal problems, learning disabilities, seizures, and autism. However, some individuals with the deletion are only mildly affected, and sometimes apparently unaffected. A mother and her child, both with the deletion, are shown in Figure 17.24. Variable penetrance and lack of highly distinctive features make genetic counseling for this genomic imbalance highly problematic.

This locus is now known for its role in determining the thrombocytopenia-absent radius (TAR) syndrome (Figure 17.25). In addition to thrombocytopenia the condition is defined by the absence of the radius but preservation of the thumb. In cohort studies, a common 200kb microdeletion of 1q21.1 (adjacent to, but distinct from, the 1q21.1 microdeletion already described) was found in all affected individuals and a third of unaffected family members, suggesting that the deletion alone is not sufficient to cause the phenotype. When it was found that a small number of TAR patients did not have a 1q21.1 microdeletion but a truncating mutation of the



**FIGURE 17.23** This person shows the characteristic facial features of deletion 17q21.31 syndrome. The face is long and the nose somewhat tubular or pear-shaped, and the nasal tip bulbous. There is developmental delay. (Courtesy Dr. David Koolen, Nijmegen, Netherlands.)



**FIGURE 17.24** **A**, This mother and child have deletion 1q21.1 syndrome. They bear a resemblance to each other and there is evidence of mild development delay and small head size. **B**, The same child nearly 1 year after the first picture.



**FIGURE 17.25** A child with thrombocytopenia-absent radius (TAR) syndrome. In this limb malformation the thumb is preserved (Reproduced with permission from Goldfarb CA, Wustrack R, Pratt JA, et al 2007 Thumb Function and Appearance in Thrombocytopenia: Absent Radius Syndrome. *J Hand Surg* 32:157–161.)

*RBM8A* gene at the same locus, further studies showed that the non-deleted allele always harbored one of two low-frequency SNPs in regulatory elements of *RBM8A*. TAR is therefore a syndrome caused by compound heterozygosity at this locus, usually with a typical microdeletion on one allele.

### Deletion 16p11.2 Syndrome

The microarray-CGH era of the last 10 years has yielded a significant number of new microdeletion and microduplication syndromes and more such conditions will continue to be delineated. One of the most common imbalances seen in clinical practice occurs at 16p11.2. The microdeletion condition (Figure 17.26) is very variable clinically and the precise extent and position of the loss of genomic material tends to be related to the severity. So-called ‘type 1’ deletion cases are most likely to give rise to the recognizable features, characterized by low muscle tone, delay in starting to speak and in language development, mild developmental delay/learning disability, susceptibility to autism/autistic spectrum disorder and seizures, minor facial dysmorphisms, and a tendency to both be overweight and have an enlarged head circumference. Some individuals show no unusual features or neurodevelopmental problems and when familial, there may be marked variation between those with the deletion. Overall, del16p11.2 is found in approximately 1% of children with autism, and around 3 in 10,000 people from the general population.

### Duplication 16p11.2

The reciprocal imbalance at 16p11.2, the microduplication, probably occurs at roughly the same frequency as the microdeletion both in the general population and in autistic spectrum disorder. The features overlap considerably regarding mild developmental and language delay, susceptibility to both seizures and mental health problems, and the presence of minor facial dysmorphisms. It is also very variable. If anything there is a tendency to display the opposite physical characteristics compared with deletion cases, i.e., the individual is more likely



**FIGURE 17.26** A child with deletion 16p11.2. The phenotype is not highly distinctive and dysmorphic features are 'soft'. Apart from mild neurodevelopmental problems there is a tendency towards being overweight and having a relatively large head.

to have mild short stature, be underweight, and have a small head circumference (Figure 17.27).

### Chromosome 15q Deletions and Microdeletions

The complexity of deletions and microdeletions affecting chromosome 15q illustrate the vast range of molecular cytogenetic aberrations that has been uncovered through microarray-CGH technology, which as a consequence has stimulated a wealth of medical genetic research with important clinical application. Deletions can occur anywhere on 15q and, in general, the larger the deletion the more severe will be the



**FIGURE 17.27** A child with duplication 16p11.2. Apart from mild neurodevelopmental problems and soft dysmorphic features there is a tendency towards small stature and a relatively small head.

phenotype and clinical problems. However, the *proximal* 15q region (Figure 17.28) has been an area of particular interest, largely because of its association with Prader-Willi and Angelman syndromes.

As discussed more fully above (p. 244), a relatively large deletion encompassing 15q11-q13 will give rise to Prader-Willi syndrome when this occurs on the paternally-derived chromosome 15, and Angelman syndrome when the maternally-derived 15 is deleted. In terms of the DNA structure, the region contains a number of LCRs, and these regions of repetitive sequence are susceptible to rearrangements with several identified 'breakpoints'—bp1, bp2, and bp3 (see Figure 17.28). Deletions between bp1 and bp2, approximately 500kb (0.5Mb) in size, give rise to deletion 15p11.2 syndrome. This is associated with a variable phenotype, or sometimes none at all. Mostly, however, the pattern is one of mild learning difficulties, behavioral and emotional problems including autistic spectrum disorder, speech delay and an increased risk of a seizure disorder. Birth defects are unusual. The role of the particular genes that are deleted (see Figure 17.28) has not been fully elucidated.

Virtually the same pattern of fairly non-specific neurodevelopmental problems affects children, and older individuals, with a deletion of 15q13.3, and it may have been transmitted by a parent who is essentially unaffected.

## Chromosome Disorders and Behavioral Phenotypes

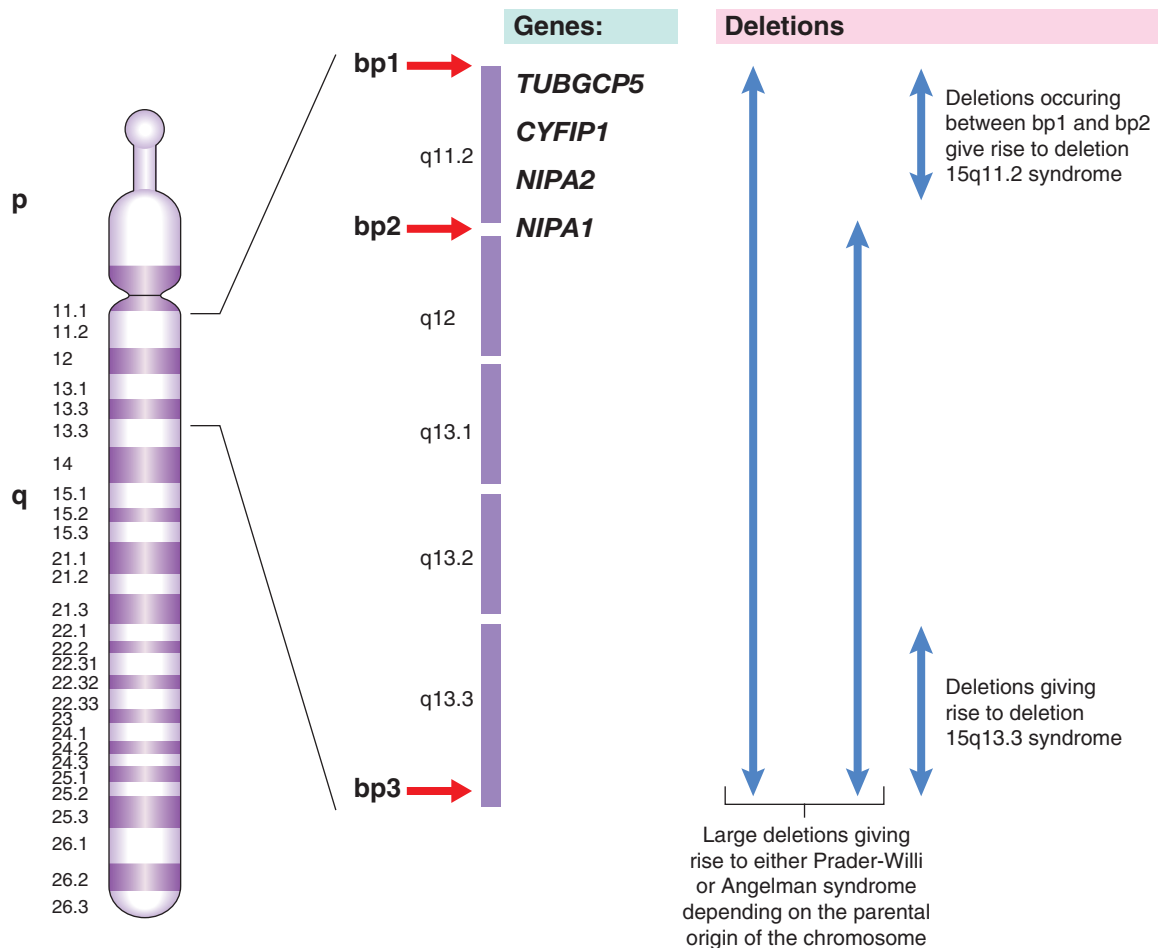
The distinctive behavior of children with Williams syndrome—their outgoing 'cocktail party manner'—has been recognized as part of the condition for a long time. As the microdeletion conditions have emerged, it has been increasingly clear that patterns of behavior can reliably be attributed to certain disorders. This is very striking in Smith-Magenis syndrome, but also apparent to a lesser extent in deletion 22q11, cri-du-chat, and Angelman and Prader-Willi syndromes. It is also apparent in the aneuploidies (Down and Klinefelter syndromes), as well as in 47,XXX and 47,XYY and fragile X syndromes. Behavioral phenotypes have therefore become an area of considerable interest to clinical scientists and the observations lend support to the belief that behavior, to a greater or lesser extent, is genetically determined. In studying chromosome disorders we are of course looking at genetically abnormal situations, and from this we cannot necessarily extrapolate directly to 'normal' situations. For the latter, twin studies have provided substantial and valuable information. This field of study remains complex and understandably controversial. However, most now accept that behavior is a complex interaction of genetic background, physical influences during early development (e.g., fetal well-being), nurturing experiences, family size, culture, and belief systems.

## Chromosomal Breakage Syndromes

A small number of hereditary disorders are characterized by an excess of chromosome breaks and gaps as well as an increased susceptibility to neoplasia. The chromosome breakages that are acquired, i.e., occur as *somatic* events and predispose to malignancy, are considered in Chapter 14.

### Ataxia Telangiectasia

This is an autosomal recessive disorder that presents in early childhood with ataxia, oculocutaneous telangiectasia (Figure



**FIGURE 17.28** The complexity of deletions occurring at the proximal chromosome 15q region. Large proximal deletions of 15q11-q13 give rise to Prader-Willi or Angelman syndromes depending on the parental origin of the deleted chromosome; deletions between bp1 and bp2 give rise to deletion 15q11.2; and deletions of 15q13.3 also occur.

17.29), radiation sensitivity, and susceptibility to sinus and pulmonary infection (p. 173). The risk of neoplasia developing is in the region of 35% to 40%, of which approximately 85% are leukemias or B-cell lymphomas. The risk of other cancers is increased several-fold, e.g., a two- to three-fold increased risk of breast cancer. Cells from patients show an increase in spontaneous chromosome abnormalities, such as chromatid gaps and breaks, which are enhanced by radiation. The gene for ataxia telangiectasia is called *ATM* and maps to chromosome 11q23. The protein product is thought to act as a 'checkpoint' protein kinase, which interacts with the *TP53* and *BRCA1* gene products to arrest cell division and thereby allow repair of radiation-induced chromosome breaks before the S phase in the cell cycle (p. 30).

### Bloom Syndrome

Children with this autosomal recessive disorder are small with a light-sensitive facial rash and reduced immunoglobulin levels (IgA and IgM). The risk of lymphoreticular malignancy is approximately 20%. Cultured cells show an increased frequency of chromosome breaks, particularly if they are exposed in vitro to ultraviolet light. The gene for Bloom syndrome maps to chromosome 15q26, where it encodes one member of a group of enzymes called the DNA helicases (p. 10). These are responsible for unwinding double-stranded DNA before replication, repair, and recombination. Normally the Bloom syndrome gene

plays a major role in maintaining genome stability. When defective in the homozygous state, DNA repair is impaired and the rate of recombination between sister chromatids is increased dramatically. This can be demonstrated by looking for sister chromatid exchanges.



**FIGURE 17.29** Ocular telangiectasia in a child with ataxia telangiectasia.



**FIGURE 17.30** Bilateral radial aplasia with absent thumbs in an infant with Fanconi anemia.

### Fanconi Anemia

This autosomal recessive disorder is associated with upper limb abnormalities involving the radius and thumb (Figure 17.30), increased pigmentation, and bone marrow failure leading to deficiency of all types of blood cells (i.e., pancytopenia). There is also an increased risk of neoplasia, particularly leukemia, lymphoma, and hepatic carcinoma. Multiple chromosomal breaks are observed in cultured cells (Figure 17.31) and the basic defect lies in the repair of DNA strand cross-links. There are at least 16 known subtypes of Fanconi anemia, each caused

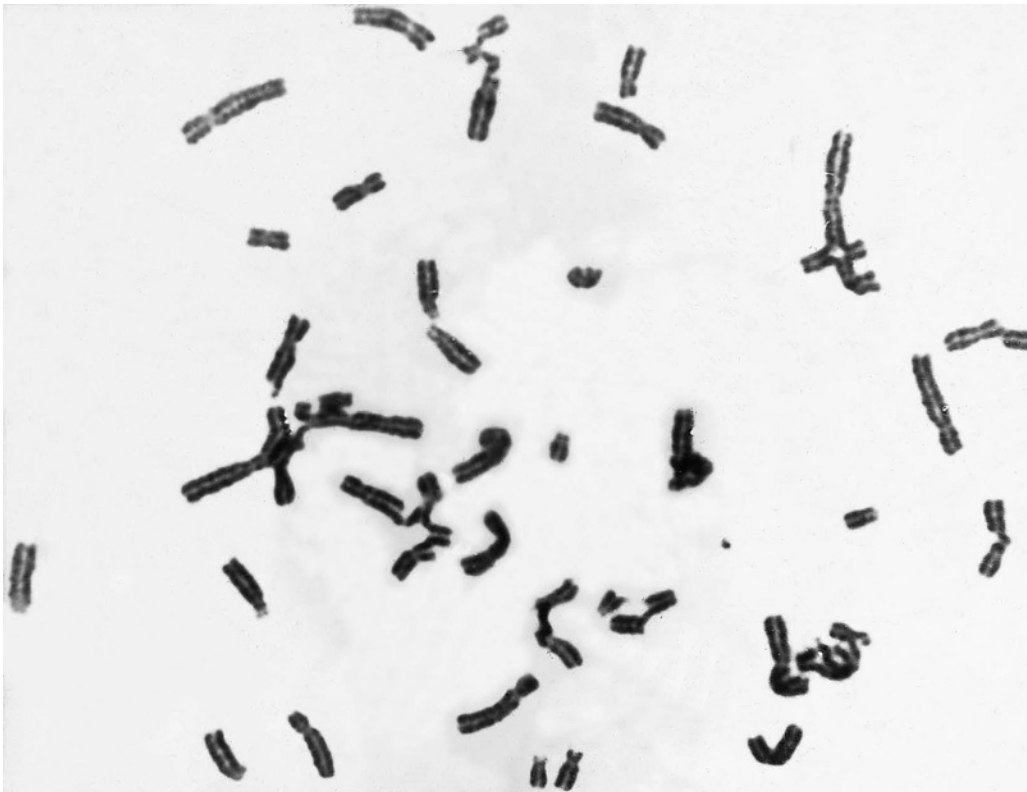
**Table 17.9** The Sub-Types of Fanconi Anemia: Genes and Loci

Fanconi Sub-Type	Fanconi Gene	Chromosomal Locus
FANCA	<i>FANCA</i>	16q24.3
FANCB	<i>FANCB</i>	Xp22
FANCC	<i>FANCC</i>	9q22
FANCD1	<i>BRCA2</i>	13q12
FANCD2	<i>FANCD2</i>	3p25
FANCE	<i>FANCE</i>	6p22
FANCF	<i>FANCF</i>	11p15
FANCG	<i>XRCC9</i>	9p13
FANCI	<i>FANCI</i>	15q25
FANCI	<i>BRIP1</i>	17q22
FANCL	<i>PHF9</i>	2p16
FANCN	<i>PALB2</i>	16p12
FANCO	<i>RAD51C</i>	17q22
FANCP	<i>SLX4</i>	16p13
FANCQ	<i>ERCC4</i>	16p13
FANCT	<i>UBE2T</i>	1q31

by recessive mutations at different autosomal loci (Table 17.9), the most common of which is type A.

### Xeroderma Pigmentosa

This exists in at least seven different forms, all of which show autosomal recessive inheritance. Patients present with a light-sensitive pigmented rash and usually die from skin malignancy in sun-exposed areas before the age of 20 years (Figure 17.32). Cells cultured from these patients show chromosome abnormalities only after exposure to ultraviolet light. These disorders



**FIGURE 17.31** Multiple chromosome breaks and gaps in a metaphase spread prepared from a child with Fanconi anemia.

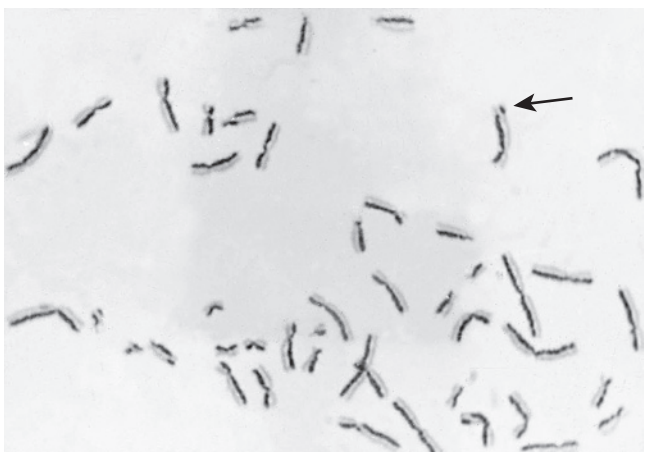


**FIGURE 17.32** Xeroderma pigmentosa: skin features with multiple melanomas and non-melanoma skin cancers. (Courtesy of Dr Shehla Mohammed, Guy's Hospital, London.)

are due to defects in the nucleotide excision repair pathway. This involves endonuclease cleavage 5' and 3' to each damaged nucleotide, excision of the damaged nucleotide(s), and finally restoration of the damaged strand using the intact opposite strand as a template.

### Chromosome Breakage and Sister Chromatid Exchange

Strong evidence of increased **chromosome instability** is provided by the demonstration of an increased number of **sister chromatid exchanges (SCEs)** in cultured cells. An SCE is an exchange (crossing over) of genetic material between the two chromatids of a chromosome in mitosis, in contrast to recombination in meiosis I, which is between homologous chromatids. SCEs can be demonstrated by differences in the uptake of certain stains by the two chromatids of each metaphase chromosome after two rounds of cell division in the presence of the thymidine analog 5-bromodeoxyuridine (BUdR), which becomes incorporated in the newly synthesized DNA (Figure 17.33). There are normally about 10 SCEs per cell, but the number is greatly increased in cells from patients with Bloom syndrome and xeroderma pigmentosa. In the latter condition,



**FIGURE 17.33** Chromosome preparation showing sister chromatid exchanges (arrow).

this is apparent only after the cells have been exposed to ultraviolet light.

It is not clear how SCEs relate to the increased chromosome breakage observed in these two disorders, but it is thought that the explanation could involve one of the steps in DNA replication. It is also of interest that the number of SCEs in normal cells is increased on exposure to certain carcinogens and chemical mutagens. For this reason the frequency of SCEs in cells in culture has been suggested as a useful *in vitro* test of the carcinogenicity and mutagenicity of chemical compounds (p. 21).

### Indications for Chromosomal/Microarray-CGH Analysis

It should be apparent from the contents of this chapter that chromosome abnormalities can present in many different ways. Consequently it is appropriate to consider the indications for chromosome analysis, which now means **microarray-CGH** in the overwhelming majority of situations, under a number of different headings (Box 17.2).

#### Multiple Congenital Abnormalities

Every child with multiple (or a single) congenital abnormalities should have chromosome or microarray-CGH studies undertaken, and this also applies to any patient with dysmorphic features. This is important for several reasons:

1. Establishing a chromosomal diagnosis will prevent further potentially unpleasant investigations being undertaken.
2. Information about the prognosis can be provided, along with details of the relevant support group and an offer of contact with other families.
3. A chromosomal diagnosis should facilitate accurate genetic risk counseling.

Although it can be very distressing for parents to be told that their child has a chromosome abnormality, they will often be relieved that an explanation for their child's problems has been found.

#### Unexplained Learning Difficulties and Neurodevelopmental Disorders

Chromosome abnormalities cause at least one-third of the 50% of learning difficulties that are attributable to genetic factors. Although most children with a chromosome abnormality have other features such as growth retardation and physical anomalies, this is not always so. Along with microarray-CGH studies it is important not to forget that fragile X syndrome might be a possibility as this will need to be specifically requested for the molecular analysis.

#### Box 17.2 Indications for Chromosome Analysis

Multiple congenital abnormalities  
 The presence of dysmorphic features  
 Unexplained mental retardation and neurodevelopmental disorders  
 Sexual ambiguity or disorder of sexual development  
 Infertility  
 Recurrent miscarriage  
 Unexplained stillbirth  
 Malignancy and chromosome breakage syndromes

## Sexual Ambiguity

The birth of a child with ambiguous genitalia should be regarded as a medical emergency, not only because of the inevitable parental anxiety, but also because of the importance of ruling out the potentially life-threatening diagnosis of salt-losing congenital adrenal hyperplasia (p. 261).

Disorders of sexual development presenting in later life with problems such as delayed puberty, primary amenorrhea or male gynecomastia are also strong indications for chromosome analysis as a first-line investigation. This can provide a diagnosis such as Turner syndrome (45,X) or Klinefelter syndrome (47,XXY). Alternatively a normal microarray-CGH will stimulate a search for other possible explanations, such as an endocrine abnormality.

## Infertility and Recurrent Miscarriage

Unexplained involuntary infertility should prompt a request for chromosome studies, particularly if investigations reveal evidence of azoospermia in the male partner. At least 5% of such men are found to have Klinefelter syndrome. More rarely a complex chromosome rearrangement such as a translocation can cause such severe mechanical disruption in meiosis that complete failure of gametogenesis ensues.

Some couples experience recurrent pregnancy loss—usually defined as more than three spontaneous miscarriages. Often no explanation is found and many such couples go on to have successful pregnancies. However, in 3% to 6% one partner is found to carry a chromosome rearrangement that predisposes to severe imbalance through malsegregation at meiosis (p. 30). Consequently it is now standard practice to offer chromosome analysis to all such couples.

## Unexplained Stillbirth/Neonatal Death

The presence of growth retardation and at least one congenital abnormality in a stillbirth or neonatal death is an indication for microarray-CGH studies based on analysis of blood or skin collected from the baby before or as soon after death as possible.

Skin fibroblasts continue to be viable for several days after demise. In cases of stillbirth and neonatal death where the infant has no congenital anomaly or dysmorphic features the chance of a positive finding on microarray-CGH is small, and attention is increasingly turning to exome sequencing in this group.

## Malignancy and Chromosome Breakage Syndromes

Certain types of leukemia and many solid tumors, such as retinoblastoma (pp. 182, 245) and Wilms tumor (p. 243), are associated with specific chromosomal abnormalities that can be of both diagnostic and prognostic value. Clinical features suggestive of a chromosome breakage syndrome (p. 250), such as a combination of photosensitivity and short stature, should also lead to appropriate chromosome fragility studies, such as analysis of sister chromatid exchanges.

## FURTHER READING

Gardner, R.J.M., Sutherland, G.R., 1996. Chromosome abnormalities and genetic counseling, second ed. Oxford University Press, Oxford.

*A useful updated guide to genetic counseling in families with a chromosome disorder.*

Jacobs, P.A., Browne, C., Gregson, N., et al., 1992. Estimates of the frequency of chromosome abnormalities detectable in unselected newborns using moderate levels of banding. *J. Med. Genet.* 29, 103–108.

*A review of the results of more than 14,000 prenatal diagnoses with estimates of the incidence of chromosome abnormalities in term infants.*

Ratcliffe, S., 1999. Long term outcome of children of sex chromosome abnormalities. *Arch. Dis. Child.* 80, 192–195.

*A very useful and clear description of the cognitive and social outcomes of long-term follow-up studies of sex chromosome aneuploidies.*

Unique—The Rare Chromosome Disorder Support Group. <<http://www.rarechromo.co.uk/html/home.asp>>.

*Unique produce an excellent series of guides for specific chromosome disorders that can be downloaded free of charge.*

## ELEMENTS

- Chromosome abnormalities account for 50% of all spontaneous miscarriages and are present in 0.5% to 1.0% of all newborn infants.
- Down syndrome is the most common autosomal chromosomal syndrome with a strong association between increasing incidence and advancing maternal age. Some 95% of all cases are caused by trisomy 21. Chromosome studies are necessary in all cases so that the rare but important cases due to unbalanced familial Robertsonian translocations can be identified.
- An ever-expanding number of chromosome microdeletion syndromes are being recognized. These have helped in gene mapping and in enhancing understanding of underlying genetic mechanisms such as imprinting. Microdeletions of chromosome 15q are found in both Angelman and Prader-Willi syndromes, depending whether maternally or paternally derived, respectively.
- Triploidy is a common finding in spontaneously aborted products of conception but rare in a live-born infant. Some children with diploidy/triploidy mosaicism present with learning difficulties and areas of depigmentation, a condition known as hypomelanosis of Ito.
- Sex chromosome abnormalities include Klinefelter syndrome (47,XXY), Turner syndrome (45,X), the XYY syndrome (47,XYY), and the triple X syndrome (47,XXX). In all of these conditions, intelligence is either normal or only mildly impaired. Infertility is the rule in Klinefelter and Turner syndromes. Fertility is normal in the XYY and the triple X syndrome.
- The fragile X syndrome is the most common inherited cause of learning difficulties. It is associated with a fragile site on the long arm of the X chromosome and shows modified X-linked inheritance. Affected males have moderate-to-severe learning difficulties; carrier females can show mild learning difficulties. At the molecular level there is expansion of a CGG triplet repeat, which can exist as a premutation or a full mutation.
- The chromosome breakage syndromes are rare autosomal recessive disorders characterized by increased chromosome breakage in cultured cells and an increased tendency to neoplasia, such as leukemia and lymphoma. They are caused by underlying defects in DNA repair.



# Inborn Errors of Metabolism

In this chapter we consider single-gene biochemical or metabolic diseases, usually known as **inborn errors of metabolism** (IEMs), including mitochondrial disorders. The range of known disorders is vast, so only an overview is possible, but it is hoped that the reader will gain a flavor of this fascinating area of medicine. At the beginning of the twentieth century, Garrod introduced the concept of ‘chemical individuality’, leading in turn to the concept of IEMs. Beadle and Tatum later developed the idea that metabolic processes, whether in humans or any other organism, proceed by steps. They proposed that each step was controlled by a particular enzyme and that this, in turn, was the product of a particular gene. This was referred to as the **one gene–one enzyme (or protein)** concept.

In excess of 600 IEMs are known that can be grouped by the main class of metabolite, metabolic pathway, enzyme function, or cellular organelle involved, and [Table 18.1](#) shows an adaptation of the classification of the Society for the Study of IEM (SSIEM). In a substantial longitudinal study of children with IEMs in British Columbia, published in 2000, the overall incidence of IEMs in the population was approximately 40 per 100,000 live births, and this was estimated to make up approximately 15% of all single gene disorders in their population. Most IEMs follow autosomal recessive or X-linked recessive inheritance, a few autosomal dominant, and those due to mitochondrial mutations follow matrilinear inheritance. In autosomal IEMs the defective protein in most cases is a diffusible enzyme, and there is usually sufficient residual activity in the heterozygous state (loss-of-function, see [p. 20](#)) for the enzyme to function normally in most situations. If, however, the reaction catalyzed by an enzyme is rate limiting (haploinsufficiency, see [p. 20](#)) or the gene product is part of a multimeric complex (dominant-negative, see [p. 20](#)), the disorder can manifest in the heterozygous state and follow dominant inheritance ([p. 66](#)).

It is only possible here to touch on the vast array of IEMs and describe some of those more commonly encountered.

## Disorders of Amino Acid and Peptide Metabolism

This large group of IEMs has many sub-divisions (see [Table 18.1](#)) and we consider the more well-known groups.

### Disorders of Phenylalanine or Tyrosine Metabolism

#### Phenylketonuria

Children with phenylketonuria (PKU), if untreated, are severely intellectually impaired and often develop seizures. There is a deficiency of the enzyme required for the conversion of phenylalanine to tyrosine, phenylalanine hydroxylase

*Life ... is a relationship between molecules.*

LINUS PAULING

*The existence of chemical individuality follows of necessity from that of chemical specificity, but we should expect the differences between individuals to be still more subtle and difficult of detection.*

ARCHIBALD GARROD (1908)

(PAH)—causing a ‘genetic block’ in the metabolic pathway ([Figure 18.1](#)).

PKU was the first genetic disorder in humans shown to be caused by a specific enzyme deficiency, by Jervis in 1953. As a result of the enzyme defect, phenylalanine accumulates and is converted into phenylpyruvic acid and other metabolites that are excreted in the urine. The enzyme block leads to a deficiency of tyrosine, with a consequent reduction in melanin formation, and children therefore often have blond hair and blue eyes ([Figure 18.2](#)). In addition, areas of the brain that are usually pigmented, such as the substantia nigra, may also lack pigment.

#### Treatment of PKU

An obvious method of treating children with PKU would be to replace the missing enzyme, but this is not simply achieved ([p. 205](#)). Bickel, just 1 year after the enzyme deficiency had been identified, suggested that PKU could be treated by removal of phenylalanine from the diet and this has proved effective. If PKU is detected early enough in infancy, intellectual impairment can be prevented by giving a phenylalanine restricted diet. Phenylalanine is an essential amino acid and therefore cannot be removed entirely from the diet. By monitoring the level of phenylalanine in the blood, it is possible to supply sufficient amounts to meet normal requirements whilst avoiding toxic levels, which would result in brain damage. After brain development is complete, dietary restriction can be relaxed—from adolescence onward.

The intellectual impairment seen in children with phenylketonuria is likely due to toxic levels of phenylalanine, and/or its metabolites, rather than a deficiency of tyrosine, of which adequate amounts are present in a normal diet. Both prenatal and postnatal factors may be responsible for developmental delay in untreated PKU.

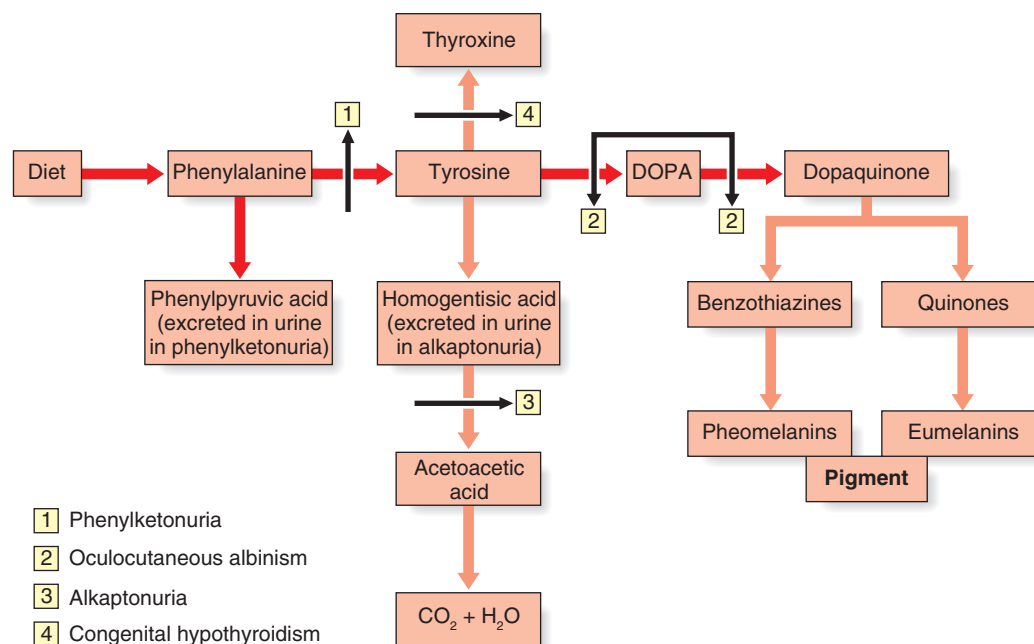
#### Diagnosis of PKU

PKU affects approximately 1 in 10,000 people in Western Europe and was the first IEM routinely screened for in newborns.

**Table 18.1** Classification of Inborn Errors of Metabolism\*

<b>1 Disorders of Amino Acid and Peptide Metabolism</b>	<b>9 Congenital Disorders of Glycosylation and Other Disorders of Protein Modification</b>
1.1 Urea cycle disorders & inherited hyperammonemias	9.1 Protein N-glycosylation
1.2 Organic acidurias	9.2 Protein O-glycosylation
1.3 Metabolism of branched-chain amino acids (not organic acidurias)	9.3 Glycosphingolipid & glycosylphosphatidylinositol anchor glycosylation
1.4 Phenylalanine or tyrosine metabolism	9.4 Multiple glycosylation & other glycosylation pathways
1.5 Metabolism of sulfur amino acids	9.5 Protein ubiquitinylation
1.6 Histidine, tryptophan or lysine metabolism	<b>10 Lysosomal Disorders</b>
1.7 Serine, glycine or glycerate metabolism	10.1 Mucopolysaccharidoses
1.8 Ornithine or proline metabolism	10.2 Oligosaccharidoses
1.9 Amino acid transport	10.3 Sphingolipidoses
1.10 Amino acid metabolism	10.4 Ceroid lipofuscinoses, neuronal (CLN)
1.11 Gamma-glutamyl cycle	10.5 Lysosomal export disorders
1.12 Other peptide metabolism	10.6 Other lysosomal disorders
<b>2 Disorders of Carbohydrate Metabolism</b>	<b>11 Peroxisomal Disorders</b>
2.1 Galactose metabolism	11.1 Peroxisome biogenesis
2.2 Fructose metabolism	11.2 Rhizomelic chondrodysplasia punctata
2.3 Pentose metabolism	11.3 Peroxisomal alpha-, beta-, & omega-oxidation
2.4 Glycerol metabolism	11.4 Other peroxisomal disorders
2.5 Glyoxylate metabolism	<b>12 Disorders of Neurotransmitter Metabolism</b>
2.6 Glucose transport	12.1 Metabolism of biogenic amines
2.7 Gluconeogenesis	12.2 Metabolism of gamma-aminobutyrate
2.8 Glycogen storage disorders	<b>13 Disorders in the Metabolism of Vitamins and (Non-Protein) Cofactors</b>
<b>3 Disorders of Fatty Acid and Ketone Body Metabolism</b>	13.1 Folate metabolism & transport
3.1 Lipolysis	13.2 Cobalamin absorption, transport & metabolism
3.2 Carnitine transport & the carnitine cycle	13.3 Pterin metabolism
3.3 Mitochondrial fatty acid oxidation	13.4 Vitamin D metabolism & transport
3.4 Ketone body metabolism	13.5 Biotin metabolism
3.5 Other fatty acid & ketone body metabolism	13.6 Pyridoxine metabolism
<b>4 Disorders of Energy Metabolism</b>	13.7 Thiamine metabolism
4.1 Pyruvate metabolism	13.8 Molybdenum cofactor metabolism
4.2 Citric acid cycle	13.9 Other vitamins & cofactors
4.3 Mitochondrial respiratory chain	<b>14 Disorders in the Metabolism of Trace Elements and Metals</b>
4.4 Mitochondrial membrane transport	14.1 Copper metabolism
4.5 Unspecified mitochondrial disorders	14.2 Iron metabolism
4.6 Creatine metabolism	14.3 Zinc metabolism
4.7 Other energy metabolism	14.4 Phosphate, calcium & vitamin D metabolism
<b>5 Disorders in the Metabolism of Purines, Pyrimidines, and Nucleotides</b>	14.5 Magnesium metabolism
5.1 Purine metabolism	14.6 Other trace elements and metals
5.2 Pyrimidine metabolism	<b>15 Disorders and Variants in the Metabolism of Xenobiotics</b>
5.3 Nucleotide metabolism	15.1 Cytochrome P450-mediated oxidation
<b>6 Disorders of the Metabolism of Sterols</b>	15.2 Other enzymes that oxidise xenobiotics
6.1 Sterol biosynthesis	15.3 Xenobiotics conjugation
6.2 Bile acid biosynthesis	15.4 Xenobiotics transport
6.3 Bile acid metabolism & transport	
6.4 Other metabolism of sterols	
<b>7 Disorders of Porphyrin and Heme Metabolism</b>	
<b>8 Disorders of Lipid and Lipoprotein Metabolism</b>	
8.1 Inherited hypercholesterolemias	
8.2 Inherited hypertriglyceridemias	
8.3 Inherited mixed hyperlipidemias	
8.4 High density lipoprotein metabolism	
8.5 Inherited hypolipidemias	
8.6 Other lipid & lipoprotein metabolism	
8.7 Unspecified disorders of lipid & lipoprotein metabolism	

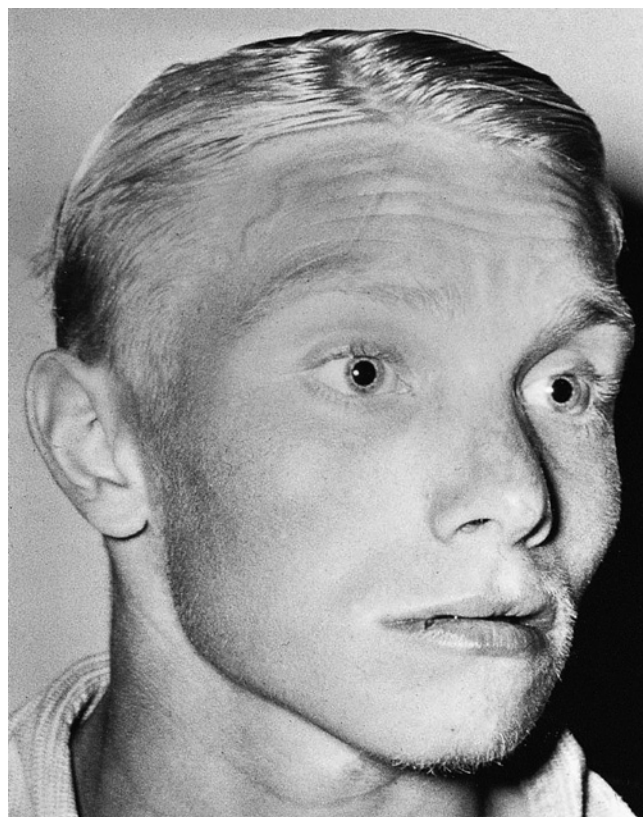
\*Adapted from Society for the Study of IEMs, 2011.



**FIGURE 18.1** Sites of 'biochemical block' in phenylketonuria, alkaptonuria, congenital hypothyroidism, and oculocutaneous albinism.

The test detects the presence of the metabolite of phenylalanine—phenylpyruvic acid—in the urine by its reaction with ferric chloride, or through increased levels of phenylalanine in the blood. The latter, originally known as the Guthrie test and now Newborn Bloodspot Screening, involved analyzing blood

from newborns and comparing the amount of growth induced by the sample, against standards, in a strain of the bacterium *Bacillus subtilis*, which requires phenylalanine for growth. This has been replaced by the use of a variety of biochemical assays of phenylalanine levels.



**FIGURE 18.2** Face of a male with phenylketonuria; note the fair complexion.

### Heterogeneity of Hyperphenylalaninemia

Raised phenylalanine levels in the newborn period may be due to causes other than PKU. Rarely, newborns have a condition called benign hyperphenylalaninemia, caused by a transient immaturity of liver cells to metabolize phenylalanine. Treatment is not necessary because they are not at risk of developing learning disability. However, there are two other rare but serious causes of hyperphenylalaninemia, in which levels of the enzyme PAH are normal, but there is a deficiency of either dihydropteridine reductase or dihydrobiopterin synthase. These two enzymes help synthesize tetrahydrobiopterin, a cofactor necessary for normal activity of PAH. Both disorders are more serious than classic PKU because there is a high risk of mental retardation despite satisfactory management of phenylalanine levels.

### Mutational Basis of PKU

Hundreds of different mutations in the *PAH* gene have been identified. Certain mutations are more prevalent in specific population groups and, in western Europeans with PKU, they are found on the background of a limited number of DNA haplotypes. Interestingly though, a variety of different individual mutations has been found in association with some of these haplotypes.

### Maternal Phenylketonuria

Children born to mothers with phenylketonuria have an increased risk of learning disability even when their mothers are on closely controlled dietary restriction. It has been suggested that the reduced ability of the mother with PKU to

deliver an appropriate amount of tyrosine to her fetus in utero may cause reduced fetal brain growth.

### Alkaptonuria

Alkaptonuria was the original autosomal recessive IEM described by Garrod. Here there is a block in the breakdown of homogentisic acid, a metabolite of tyrosine, because of a deficiency of the enzyme homogentisic acid oxidase (see [Figure 18.1](#)). As a consequence, homogentisic acid accumulates and is excreted in the urine, which then darkens on exposure to air. Dark pigment is also deposited in certain tissues, such as the ear wax, cartilage, and joints, where it is known as ochronosis, which in joints can lead to arthritis later in life.

### Oculocutaneous Albinism

Oculocutaneous albinism (OCA) is an autosomal recessive disorder resulting from a deficiency of the enzyme tyrosinase, which is necessary for the formation of melanin from tyrosine (see [Figure 18.1](#)). In OCA there is a lack of pigment in the skin, hair, iris, and ocular fundus ([Figure 18.3](#)), and the lack of eye pigment results in poor visual acuity (usually in the range of 20/100 to 20/400) and uncontrolled pendular eye movements—nystagmus. Reduced fundal pigmentation leads to underdevelopment of the part of the retina for fine vision—the fovea—and misrouting of the optic nerve fiber radiations at the chiasm, resulting in strabismus, reduced stereoscopic vision, and altered (crossed) visually evoked potentials.



**FIGURE 18.3** Oculocutaneous albinism type 1. **A**, A young Caucasian woman. She has a small amount of pigment production as her hair is not absolutely white; **B**, the eyes of another patient: note the white eyebrows and lashes, strabismus, and trans-illumination of the iris.

### Heterogeneity of OCA

OCA is genetically and biochemically heterogeneous. Cells from those with classic albinism have no measurable tyrosinase activity, the so-called **tyrosinase-negative** form. However, cells from some persons with albinism show reduced but residual tyrosinase activity and are termed **tyrosinase positive**. This is usually reflected clinically by variable development of pigmentation of their hair and skin with age. Both types are known as tyrosinase gene-related OCA type 1.

OCA type 1 is due to mutations in the tyrosinase gene on chromosome 11q. However, linkage studies in some families with tyrosinase-positive OCA have excluded the tyrosinase gene. Some of these have a mutation in the *P* gene, the human homolog of a mouse gene called *pink-eyed dilution*, or ‘pink-eye’, located on chromosome 15q. This has been termed OCA type 2. In addition, in a proportion of families with OCA, linkage to both of these two loci has been excluded, consistent with the existence of a third locus responsible for OCA.

### Urea Cycle Disorders

The urea cycle is a five-step metabolic pathway that takes place primarily in liver cells for the removal of waste nitrogen from the amino groups of amino acids arising from the normal turnover of protein. It converts two molecules of ammonia and one of bicarbonate into urea ([Figure 18.4](#)). Deficiencies of enzymes in the urea cycle result in intolerance to protein from the accumulation of ammonia in the body—hyperammonemia. Increased ammonia levels are toxic to the central nervous system and can lead to coma and, with some untreated urea cycle disorders, death—in infancy in severe cases. They are collectively and individually rare and, with the exception of X-linked ornithine transcarbamylase deficiency, inherited as autosomal recessive traits. Other conditions in the group are citrullinemia, arginosuccinic aciduria, and hyperammonemia-hyperornithinemia-homocitrullinuria (HHH) syndrome.

### Disorders of the Metabolism of Sulphur Amino Acids

#### Homocystinuria

Homocystinuria is a recessively inherited sulfur amino-acid IEM characterized by learning disability, seizures, thrombophilia, osteoporosis, scoliosis, pectus excavatum, long fingers and toes (arachnodactyly) ([Figure 18.5](#)), and a tendency to dislocation of the lenses. The somatic features therefore resemble the autosomal dominant disorder Marfan syndrome ([p. 291](#)).

Homocystinuria results from deficiency of the enzyme cystathionine  $\beta$ -synthase and can be screened for by means of a positive cyanide nitroprusside test, which detects the presence of increased levels of homocystine in the urine. The diagnosis is confirmed by raised plasma homocystine levels. Treatment involves a low-methionine diet with cystine supplementation. A proportion of individuals with homocystinuria are responsive to the enzyme cofactor pyridoxine (i.e., the pyridoxine-responsive form). A small proportion of affected individuals have mutations in genes leading to deficiencies of enzymes involved in the synthesis of cofactors for cystathionine  $\beta$ -synthase.

### Organic Acidurias

#### Glutaric Aciduria I

Glutaric aciduria type I (glutaryl-CoA dehydrogenase deficiency) and II (multiple acyl-CoA dehydrogenase deficiency)

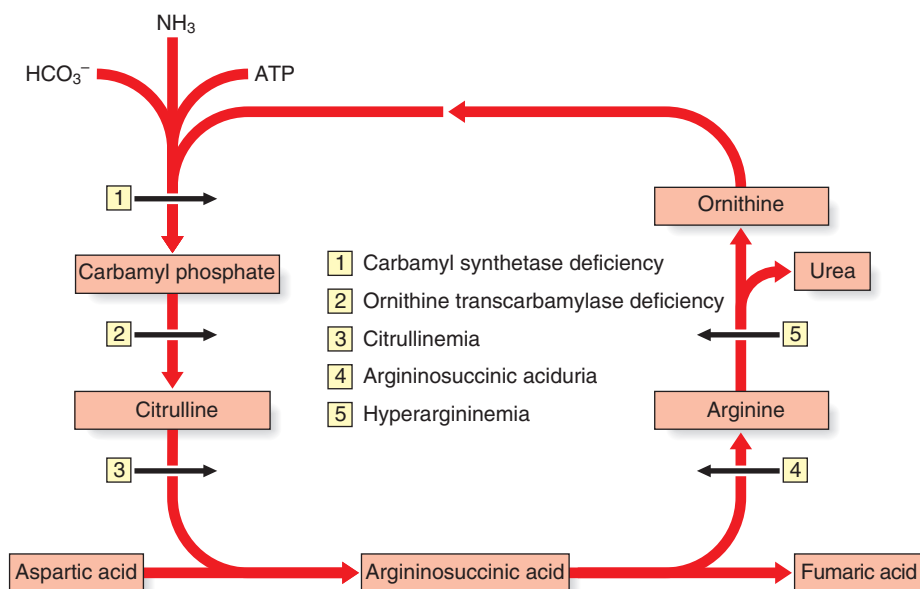


FIGURE 18.4 Diagram indicating the position of the various inborn errors of the urea cycle.

is included as an example of an organic aciduria that is intermediate in fatty-acid oxidation (see below under mitochondrial disorders). Macrocephaly is present at birth and infants suffer episodes of encephalopathy with spasticity, dystonia, seizures, and developmental delay. Treatment is by dietary restriction of glutarigenic amino acids—lysine, tryptophan, and hydroxylysine. Common among the Old Order Amish of Pennsylvania, neonatal screening has been introduced in the area.

### Methylmalonic and Propionic Acidurias

These two disorders are caused by deficiency of the enzymes methylmalonyl-CoA mutase and propionyl-CoA carboxylase,

respectively. The enzyme deficiency results in accumulation of the toxic organic-acid metabolites derived from deamination of certain amino acids, specific long-chain fatty acids, and cholesterol side chains. Children present with periodic episodes of poor feeding, vomiting, and lethargy in association with a severe metabolic acidosis, low white cell (neutropenia) and platelet (thrombocytopenia) counts, low blood sugar (hypoglycemia), and high blood ammonia levels (hyperammonemia). These episodes are often precipitated by intercurrent illness or increased protein intake, and after such an episode affected children can lose developmental skills. During these episodes there are high plasma levels of glycine (hyperglycinemia).



FIGURE 18.5 A lady with homocystinuria who presented with ectopia lentis from a young age and for many years was thought to have Marfan syndrome. **A**, showing her apparently Marfanoid habitus (long arms and legs); **B**, her facial features, which may also resemble Marfan syndrome.

Therapy for the acute episode involves the treatment of any infection, fluid replacement, correction of the metabolic acidosis, and cessation of protein intake. Long-term prophylactic treatment involves restriction of protein intake and rapid recognition and management of any intercurrent illness. A proportion of individuals affected with propionic acidemia are responsive to biotin, whereas some with methylmalonic acidemia are sensitive to vitamin B12.

### Methylglutaconic Aciduria (Barth Syndrome)

Barth syndrome, strictly speaking '3-methylglutaconic aciduria type II (MGCA2)' and also known as X-linked cardioskeletal myopathy, is characterized by congenital dilated cardiomyopathy, including endocardial fibroelastosis. It is also a generalized myopathy with growth retardation and neutropenia. Abnormal mitochondria are found in many tissues, deficient in cardiolipin, and skeletal muscle shows increased lipid levels. A variable and sometimes fluctuating increase in urinary levels of 3-methylglutaconic acid, as well as neutropenia, may be useful in achieving a diagnosis, and mutations have been identified in the *G4.5(TAZ)* gene at Xq28, but a specific enzyme defect remains elusive.

### Disorders of Branched-Chain Amino Acid Metabolism

The essential branched-chain amino acids leucine, isoleucine and valine have a part of their metabolic pathways in common. Deficiency of the enzyme involved results in maple syrup urine disease.

#### Maple Syrup Urine Disease

Newborn infants with this autosomal recessive disorder present in the first week of life with vomiting, then alternating tone, leading to death within a few weeks if untreated. The name derives from the odor of the urine—likened to that of maple syrup. The disorder is caused by a deficiency of the branched-chain ketoacid decarboxylase, producing increased urinary excretion of the branched-chain amino acids valine, leucine, and isoleucine, the presence of which suggests the diagnosis, confirmed by demonstration of the three essential branched-chain amino acids in blood. Treatment involves a diet restricting the intake of these three amino acids to the amounts necessary for growth. Affected individuals are particularly susceptible to deterioration, particularly in association with intercurrent illnesses leading to catabolic protein degradation.

### Disorders of Carbohydrate Metabolism

The inborn errors of carbohydrate metabolism are also subdivided into many categories (see [Table 18.1](#)) and include well-known intolerances such as that for lactose and a rare disorder for disaccharides. We first describe the better known conditions within the disorders of galactose and fructose metabolism respectively before considering the large group of glycogen storage disorders.

#### Classic Galactosemia

Galactosemia is an autosomal recessive disorder resulting from a deficiency of the enzyme galactose 1-phosphate uridyl transferase, necessary for the metabolism of the dietary sugar galactose. Newborns with galactosemia present with vomiting, lethargy, failure to thrive, and jaundice in the second week of life. If untreated, they develop complications that include

mental retardation, cataracts, and liver cirrhosis. Complications can be prevented by early diagnosis and feeding infants with milk substitutes that do not contain galactose or lactose—the sugar found in milk that is broken down into galactose. Early diagnosis is essential and galactosemia can be screened for by the presence of reducing substances in the urine with specific testing for galactose.

#### Hereditary Fructose Intolerance

Hereditary fructose intolerance is an autosomal recessive disorder resulting from a deficiency of the enzyme fructose 1-phosphate aldolase. Dietary fructose is present in honey, fruit, and certain vegetables, and in combination with glucose in the disaccharide sucrose in cane sugar. Individuals with hereditary fructose intolerance present at different ages, depending on when fructose is introduced into the diet. Symptoms can be minimal but might also be as severe as those seen in galactosemia, which include failure to thrive, vomiting, jaundice, and seizures. The diagnosis is confirmed by the presence of fructose in the urine and enzyme assay on an intestinal mucosal or liver biopsy sample. Dietary restriction of fructose is associated with a good long-term prognosis.

#### Glycogen Storage Disorders (GSDs)

Glycogen is the form in which the sugar glucose is stored in muscle and liver as a polymer, acting as a reserve energy source. In the GSDs glycogen accumulates in excessive amounts in skeletal muscle, cardiac muscle, and/or liver because of a variety of inborn errors of the enzymes involved in synthesis and degradation of glycogen. In addition, because of the metabolic block, glycogen is unavailable as a normal glucose source. This can result in hypoglycemia, impairment of liver function and neurological abnormalities.

In all, there are now around 30 different GSD entities identified but we briefly describe six major types. For each, there is a specific enzyme defect involving one of the steps in glycogen synthesis or degradation. Although listed by their numerical place in the classification, types II (Pompe) and V (McArdle) primarily affect muscle whilst the others primarily affect the liver. Among the rare types not discussed are Fanconi-Bickel syndrome (GSD type XI) and Aldolase A deficiency.

#### von Gierke Disease (GSD I)

von Gierke disease was the first described disorder of glycogen metabolism and results from a deficiency of the enzyme glucose-6-phosphatase, which is responsible for degradation of liver glycogen to release glucose. Infants present with an enlarged liver (hepatomegaly) and/or sweating and a fast heart rate due to hypoglycemia, which can occur after fasting of only 3 to 4 hours duration. Treatment is simple—frequent feeding and avoidance of fasting to maintain the blood sugar concentration.

#### Pompe Disease (GSD II)

Infants with Pompe disease usually present in the first few months of life with floppiness (hypotonia) and delay in the gross motor milestones because of muscle weakness. They then develop an enlarged heart and die from cardiac failure in the first or second year. Voluntary and cardiac muscle accumulates glycogen because of a deficiency of the lysosomal enzyme  $\alpha$ -1,4-glucosidase, which is needed to break down glycogen. The diagnosis can be confirmed by enzyme assay of white blood cells or fibroblasts. Early reports of enzyme replacement therapy appear promising.

### Cori Disease (GSD III)

Cori disease is caused by deficiency of the enzyme amylo-1,6-glucosidase, which is also known as the debrancher enzyme. Deficiency results in glycogen accumulation in the liver and other tissues because of the inability to cleave the 'branching' links of the glycogen polymer. Infants may present with hepatomegaly because of glycogen accumulation and/or muscle weakness. Treatment involves avoiding hypoglycemia by frequent feeding and avoiding prolonged periods of fasting.

### Andersen Disease (GSD IV)

Anderson disease results from deficiency of glycogen brancher enzyme leading to the formation of abnormal glycogen consisting of long chains with few branches that cannot be broken down by the enzymes normally responsible for glycogen degradation. Infants present with hypotonia and abnormal liver function in their first year, progressing rapidly to liver failure. No effective treatment is available apart from the possibility of a liver transplant.

### McArdle Disease (GSD V)

People with McArdle disease present with muscle cramps during exercise in the teenage years. The condition is caused by a deficiency of muscle phosphorylase, which is necessary for degradation of muscle glycogen. There is no effective treatment, although in some the muscle cramps tend to decline if exercise

is continued, probably as a result of other energy sources becoming available from alternative metabolic pathways.

### Hepatic Glycogen Phosphorylase Deficiency (GSD VI)

Hepatic phosphorylase is a multimeric enzyme complex with subunits coded for by both autosomal and X-linked genes. Deficiency of hepatic phosphorylase obstructs glycogen degradation, which results in children presenting in the first 2 years of life with hepatomegaly, hypoglycemia, and failure to thrive. Treatment is with carbohydrate supplementation.

### Disorders of Steroid Metabolism

The disorders of steroid metabolism include a number of autosomal recessive inborn errors of the biosynthetic pathways of cortisol. Virilization of a female fetus may occur together with salt loss in infants of either sex from a deficiency of the hormone aldosterone. In addition, defects of the androgen receptor result in lack of virilization of chromosomally male individuals (Figure 18.6).

### Congenital Adrenal Hyperplasia (CAH)

The diagnosis of CAH should be considered in any newborn female infant presenting with virilization of the external genitalia, because this is the most common cause of ambiguous

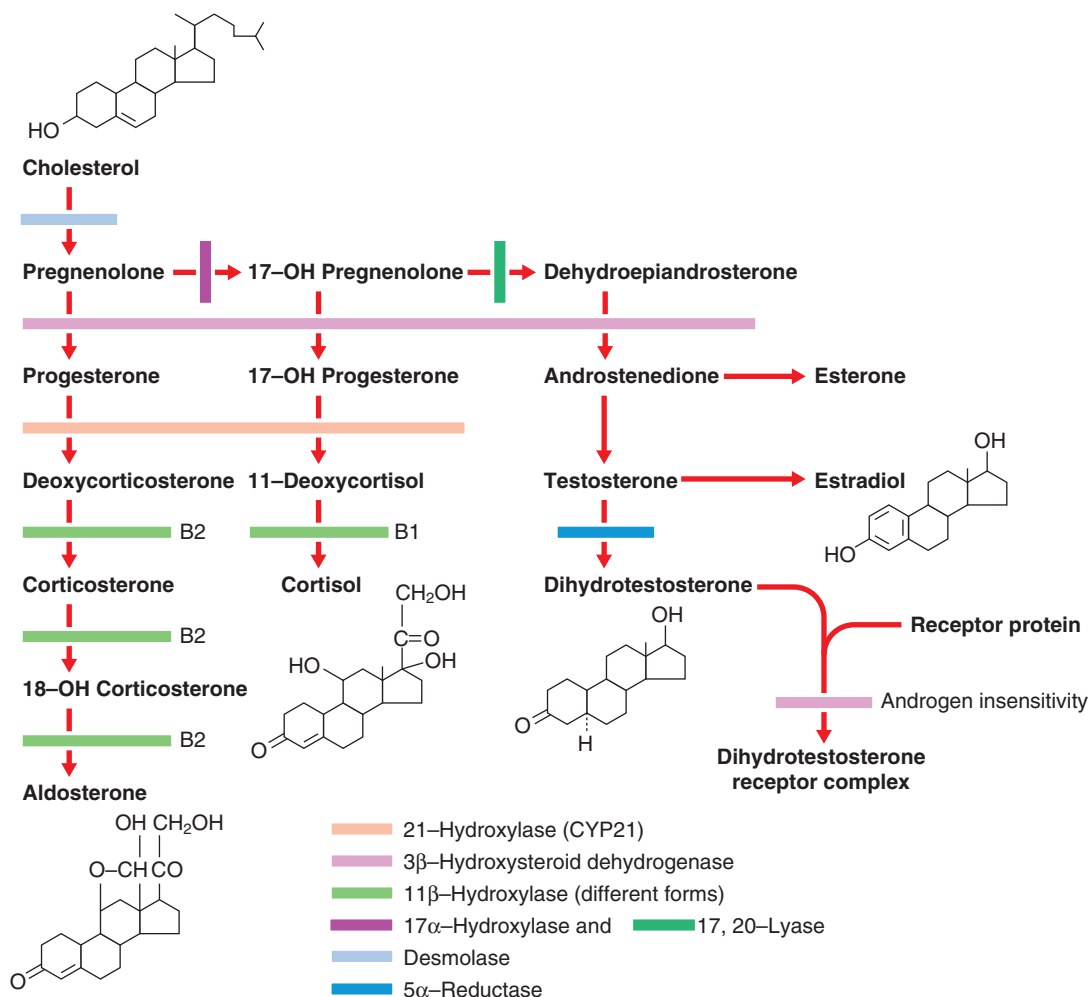


FIGURE 18.6 Steroid biosynthesis indicating the site of the common inborn errors of steroid biosynthesis.



**FIGURE 18.7** **A**, Virilized external genitalia in a female with congenital adrenal hyperplasia. **B**, A male baby with hypospadias who clearly has testes in the scrotal sacs.

genitalia in female newborns (Figure 9.34, p. 127) (Figure 18.7) (see Chapter 9 for more detail of Sex Determination and Disorders of Sex Development). 21-Hydroxylase deficiency accounts for more than 90% of cases. Approximately 25% have the salt-losing form, presenting in the second or third week of life with circulatory collapse, hyponatremia, and hyperkalemia. Less commonly, CAH is a result of deficiency of the enzymes 11 $\beta$ -hydroxylase or 3 $\beta$ -dehydrogenase, and very rarely occurs as a result of deficiencies of enzymes 17 $\alpha$ -hydroxylase and 17,20-lyase. Desmolase deficiency is very rare, with all pathways blocked, causing a reversed phenotype of ambiguous genitalia in males, and severe Addisonian crises. Males with the rare 5 $\alpha$ -reductase deficiency are significantly under-masculinized but do not suffer other metabolic problems and are raised as females during childhood. At puberty, however, the surge in androgen production is sufficient to stimulate growth of the phallus and these individuals are then visibly male. In the

inbred communities where the problem recurs and is well accepted, 'switching' to male gender in every respect is possible, even routine.

Affected females with classic CAH are virilized from accumulation of the adrenocortical steroids proximal to the enzyme block in the steroid biosynthetic pathway, many of which have testosterone-like activity (see Figure 18.6). However, they have normal Müllerian-derived internal organs. The possibility of CAH should not be forgotten, of course, in male infants presenting with circulatory collapse in the first few weeks of life.

Affected infants, in addition to requiring urgent correct assignment of gender, are treated with replacement cortisol, along with fludrocortisone if they have the salt-losing form. Virilized females may require plastic surgery later. Steroid replacement is life-long and should be increased during intercurrent illness or stress, such as surgery. Menarche in girls with salt-losing CAH is late, menstruation irregular, and they are subfertile.

### Disorders of Lipid and Lipoprotein Metabolism

This group of disorders embraces a variety of disorders affecting cholesterol, triglycerides and lipoproteins and are important because of the consequences for cardiovascular disease. Additional coverage is given in Chapter 10 and is associated with high morbidity and mortality rates through premature coronary artery disease (see Chapter 10).

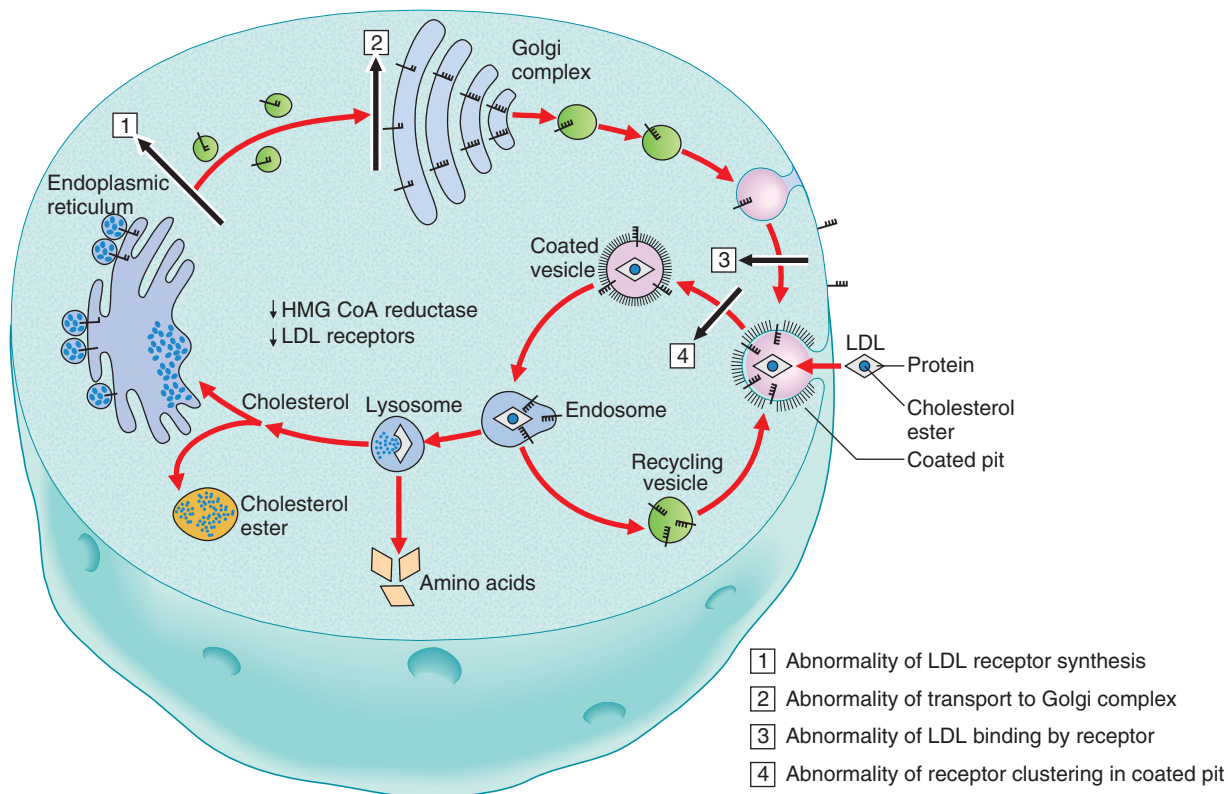
#### Familial Hypercholesterolemia

Familial hypercholesterolemia (FH) is the most common autosomal dominant single-gene disorder in Western society. Individuals have raised cholesterol levels without symptoms but carry a significant risk of developing premature coronary artery disease leading to significant morbidity and increased mortality rates (p. 140). They can present in childhood or adolescence with subcutaneous deposition of lipid, known as xanthomata (Figure 18.8). Starting with families who presented with early coronary artery disease, Brown and Goldstein unravelled the biology of the low-density lipoprotein (LDL) receptor (p. 140) and the pathological basis of FH.



**FIGURE 18.8** Legs of a person homozygous for familial hypercholesterolemia, showing multiple xanthomata. (Courtesy Dr. E. Wraith, Royal Manchester Children's Hospital, Manchester, UK.)





**FIGURE 18.9** Stages in cholesterol biosynthesis and in the metabolism of low-density lipoprotein (LDL) receptors, indicating the types of mutation in familial hypercholesterolemia. (Adapted from Brown MS, Goldstein JL 1986 A receptor-mediated pathway for cholesterol homeostasis. *Science* 232:34–47.)

Cells normally derive cholesterol from either endogenous synthesis or dietary uptake from LDL receptors on the cell surface. Intracellular cholesterol levels are maintained by a feedback system, with free cholesterol inhibiting LDL receptor synthesis as well as reducing the level of de novo endogenous synthesis.

High cholesterol levels in FH are due to deficient or defective function of the LDL receptors leading to increased levels of endogenous cholesterol synthesis. Four main classes of mutation in the LDL receptor have been identified: (1) reduced or defective biosynthesis of the receptor; (2) reduced or defective transport of the receptor from the endoplasmic reticulum to the Golgi apparatus; (3) abnormal binding of LDL by the receptor; and (4) abnormal internalization of LDL by the receptor (Figure 18.9). Specific mutations are more prevalent in certain ethnic groups because of founder effects (p. 87).

The mainstay of management is dietary restriction of cholesterol intake and drug treatment with 'statins' that reduce the endogenous synthesis of cholesterol by inhibiting the enzyme 3-hydroxy-3-methylglutaryl coenzyme A (CoA) reductase. Cholesterol levels in affected families are variable and lipid assays do not necessarily identify those with mutations. There is therefore interest in the introduction of widespread genetic testing, though most mutations are missense, which may pose problems of interpretation.

### Lysosomal Storage Disorders

In addition to the IEMs in which an enzyme defect leads to deficiency of an essential metabolite and accumulation of

intermediate metabolic precursors, there are a number of disorders in which deficiency of a lysosomal enzyme involved in the degradation of complex macromolecules leads to their accumulation. This accumulation occurs because macromolecules are normally in a constant state of flux, with a delicate balance between their rates of synthesis and breakdown. Children born with lysosomal storage diseases are usually normal initially but with the passage of time commence a downhill course of variable duration owing to the accumulation of one or more of a variety or type of macromolecules.

### Mucopolysaccharidoses

Children with one of the mucopolysaccharidoses (MPSs) present with skeletal, vascular, or central nervous system findings along with coarsening of the facial features. These features are due to progressive accumulation of sulfated polysaccharides (also known as glycosaminoglycans) caused by defective degradation of the carbohydrate side-chain of acid mucopolysaccharide.

Six different MPSs are recognized, based on clinical and genetic differences. Each specific MPS type has a characteristic pattern of excretion in the urine of the glycosaminoglycans, dermatan, heparan, keratan, and chondroitin sulfate. Subsequent biochemical investigation has revealed the various types to be due to deficiency of different individual enzymes. All but Hunter syndrome, which is X-linked, are autosomal recessive disorders.

### Hurler Syndrome (MPS I)

Hurler syndrome is the most severe MPS. Infants present in the first year with corneal clouding, a characteristic curvature

of the lower spine and subsequent poor growth. They develop hearing loss, coarse facial features, an enlarged liver and spleen, joint stiffness, and vertebral changes in the second year. These features progress together with mental deterioration and eventually death by mid-adolescence from a combination of cardiac failure and respiratory infections.

The diagnosis of Hurler syndrome was initially made by demonstrating the presence of metachromatic granules in the cells (i.e., lysosomes distended by the storage material that is primarily dermatan sulfate). Increased urinary excretion of dermatan and heparan sulfate is commonly used as a screening test, but confirmation of the diagnosis involves demonstration of reduced activity of the lysosomal hydrolase,  $\alpha$ -L-iduronidase, and direct gene analysis. Less severe allelic forms of Hurler syndrome, caused by varying levels of residual  $\alpha$ -L-iduronidase activity, were previously classified separately as Scheie disease (MPS-I S) and Hurler/Scheie disease (MPS-I H/S).

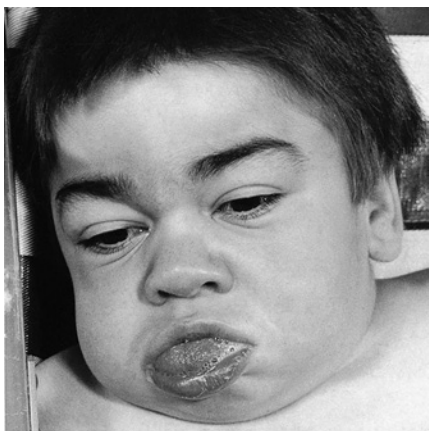
### Hunter Syndrome (MPS II)

Males with Hunter syndrome usually present aged between 2 and 5 years with hearing loss, recurrent infections, diarrhea, and poor growth. Facial features are characteristic with coarsening (Figure 18.10), the liver and spleen are enlarged, and joint stiffness occurs. Spinal radiographs show abnormal shape of the vertebrae. Progressive physical and mental deterioration occurs with death usually in adolescence.

The diagnosis is confirmed by the presence of excess amounts of dermatan and heparan sulfate in the urine, deficient or decreased activity of the enzyme iduronate sulfate sulfatase in serum or white blood cells, and direct gene analysis.

### Sanfilippo Syndrome (MPS III)

Sanfilippo syndrome is the most common MPS. Affected individuals present in their second year with mild coarsening of features, skeletal changes, and progressive intellectual loss with behavioral problems, seizures, and death in early adult life. The diagnosis is confirmed by the presence of increased urinary heparan and chondroitin sulfate excretion, and deficiency of one of four enzymes involved in the degradation of heparan sulfate: sulfaminidase (MPS-III A), *N*-acetyl- $\alpha$ -D-glucosaminidase (MPS-III B), acetyl-CoA- $\alpha$ -glucosaminidase-*N*-acetyltransferase (MPS-III C), or *N*-acetyl-glucosamine-6-sulfate sulfatase (MPS-III D). Individuals with these different enzyme deficiencies



**FIGURE 18.10** Face of a male with the mucopolysaccharidosis, Hunter syndrome. (Courtesy Dr. E. Wraith, Royal Manchester Children's Hospital, Manchester, UK.)

cannot be distinguished clinically. Direct gene testing has not proved to be very reliable.

### Morquio Syndrome (MPS IV)

Children with Morquio syndrome present at age 2 to 3 years with short stature, thoracic deformity, and curvature of the spine (kyphoscoliosis). Intelligence is normal and survival is long term, but there is a risk of spinal cord compression from progression of the skeletal involvement. The diagnosis is confirmed by the presence of keratan sulfate in the urine and deficiency of either galactosamine-6-sulphatase (MPS-IV A) or  $\beta$ -galactosidase (MPS-IV B).

### Maroteaux-Lamy Syndrome (MPS VI)

This MPS presents with Hurler-like features in early childhood, including coarse facial features, short stature with thoracic deformity, kyphosis, and restriction of joint mobility. In addition, corneal clouding and cardiac valve abnormalities develop; intelligence is normal. A milder form presents later with survival into late adulthood, in contrast to the severe form in which survival is usually only to the third decade. The diagnosis is confirmed by the presence of increased urinary dermatan sulfate excretion and arylsulfatase B deficiency in white blood cells or fibroblasts.

### Sly Syndrome (MPS VII)

This is an extremely variable MPS. Presentation ranges from skeletal features that include mild kyphoscoliosis and hip dysplasia to coarse facial features, hepatosplenomegaly, corneal clouding, cardiac abnormalities, and mental retardation, with death in childhood or adolescence. Increased urinary glycosaminoglycans excretion and  $\beta$ -glucuronidase deficiency in serum, white blood cells, or fibroblasts confirm the diagnosis.

### Treatment of the MPSs

Treatment of these disorders by enzyme replacement (p. 205) is partially successful and inevitably very expensive. Similarly, bone marrow transplantation has had varying success, biochemically, and clinically in relation to the skeletal and cerebral aspects of disease.

### Sphingolipidoses

In the sphingolipidoses, there is an inability to degrade sphingolipid, resulting in the progressive deposition of lipid or glycolipid, primarily in the brain, liver, and spleen. Central nervous system involvement results in progressive mental deterioration, often with seizures, leading to death in childhood. There are at least 16 different types, with specific enzyme deficiencies, Tay-Sachs, Gaucher, metachromatic leukodystrophy, Fabry, and Niemann-Pick diseases being the most common.

### Tay-Sachs Disease

This well-known sphingolipidosis has an incidence of approximately 1:3600 in Ashkenazi Jews (pp. 144-145). Infants usually present by 6 months of age with poor feeding, lethargy, and floppiness. Developmental regression usually becomes apparent in late infancy, feeding becomes increasingly difficult, and the infant progressively deteriorates, with deafness, visual impairment, and spasticity, which progresses to rigidity. Death

usually occurs by the age of 3 years from respiratory infection. Less severe juvenile, adult, and chronic forms are reported.

The diagnosis is supported clinically by the presence of a 'cherry-red' spot in the center of the macula of the fundus. Biochemical confirmation of Tay-Sachs disease is by demonstration of reduced hexosaminidase A levels in serum, white blood cells or cultured fibroblasts, and direct gene analysis is available. Reduced hexosaminidase A activity is due to deficiency of the a subunit of the enzyme  $\beta$ -hexosaminidase that leads to accumulation of the sphingolipid GM<sub>2</sub> ganglioside. This deficiency leads to reduced activity of the isozyme, hexosaminidase B, causing the other GM<sub>2</sub> gangliosidosis, Sandhoff disease, which presents with similar clinical features.

### Gaucher Disease

This is the most common sphingolipidosis and, as with Tay-Sachs, is relatively more frequent among Ashkenazi Jews. There are two main types based on the age of onset.

Type I, with adult onset, is the more common form and presents with febrile episodes, pain in limbs, joints, or trunk, and a tendency to pathological fractures. Clinical examination usually reveals hepatosplenomegaly and investigations show mild anemia and radiological changes in the vertebrae and proximal femora. The central nervous system is spared.

In type II, infantile Gaucher disease, central nervous system involvement is a major feature and presents at age 3 to 6 months with failure to thrive and hepatosplenomegaly. By 6 months, developmental regression and neurological deterioration occur with spasticity and seizures. Recurrent pulmonary infections cause death in the second year.

The diagnosis is confirmed by reduced activity of the enzyme glucosylceramide  $\beta$ -glucosidase in white blood cells or cultured fibroblasts.

Treatment in type I involves symptomatic analgesia, and sometimes splenectomy to prevent premature sequestration of red blood cells (hypersplenism). Initial attempts to treat adults by enzyme replacement therapy met with little success because of difficulty in obtaining sufficient quantities of enzyme and in targeting the appropriate sites. However, modification of  $\beta$ -glucosidase by the addition of mannose 6-phosphate, which targets the enzyme to macrophage lysosomes, has led to dramatic alleviation of symptoms and regression of organomegaly. The treatment is expensive, and regimens using lower doses and alternative methods to target the enzyme may be more rational.

### Metachromatic Leukodystrophy (MLD)

Also referred to as arylsulfatase A deficiency, this recessively inherited condition is variable, though tends to breed true within a family. Three basic forms are recognized: late-infantile (50–60%), juvenile (20–30%), and adult (15–20%). The earlier the age of onset, the more progressive the illness.

The *late-infantile* form presents during the second year of life with weakness, hypotonia, unsteadiness and falls, toe walking, and slurred speech. Neurodevelopment regresses, leading to increased tone, seizures, and eventually decerebrate posturing and lack of awareness. Death ensues from 3–10 years after the onset. The *juvenile* form begins between 4 years and early puberty. The presentation is more insidious but eventual cognitive and neurological decline ensues in a similar way but slower. The adult form, starting from puberty onwards, and sometimes well into adulthood, may present with decline in performance, personality change, and progressive neurological

problems including seizures. The disease course may be around 30 years.

### Fabry Disease

Fabry disease is X-linked and due to deficiency of the enzyme  $\alpha$ -galactosidase, encoded by the *GLA* gene, resulting in progressive lysosomal deposition of globotriaosylceramide in body cells and tissues. The severe form begins in childhood or adolescence with episodes of very unpleasant pain in the extremities. In due course vascular cutaneous angiokeratomas develop, sweating abnormalities are common, and characteristic corneal and lenticular opacities occur. Hematuria and deteriorating renal function leading to end-stage renal disease may occur in men in their 20s–40s. Fabry disease is a cause of hypertrophic cardiomyopathy (HCM) (p. 290) and early cerebrovascular disease.  $\alpha$ -Galactosidase activity is a routine screening test in males with HCM where there is no evidence of male-male transmission. Some heterozygous females develop milder symptoms and a later age of onset than their male counterparts.

### Niemann-Pick Disease

Infants with Niemann-Pick disease present with failure to thrive and hepatomegaly, and a cherry-red spot may be found on their macula. Developmental regression progresses rapidly by the end of the first year, with death by 4 years of age. A characteristic finding is the presence of what are called foam cells in the bone marrow from sphingomyelin accumulation. Confirmation of the diagnosis is by demonstration of deficiency of the enzyme sphingomyelinase. A less severe form without neurological involvement has been reported. As with Tay-Sachs and Gaucher diseases, it is more common in Ashkenazi Jews from eastern Europe.

## Disorders in the Metabolism of Purines, Pyrimidines, and Nucleotides

### Disorders of Purine Metabolism

#### Primary Idiopathic Gout

Gout is the classic disorder of abnormal purine metabolism. Joint pain, swelling, and tenderness are a result of the inflammatory response of the body to deposits of crystals of a salt of uric acid. In fact, only a minority of persons with gout have an IEM. The cause in most instances results from a combination of genetic and environmental factors; however, it is always important to consider disorders that can result in an increased turnover of purines (e.g., a malignancy such as leukemia) or reduced secretion of the metabolites (e.g., renal impairment) as a possible underlying precipitating cause.

#### Lesch-Nyhan Syndrome

This is a particularly disabling disorder of purine metabolism, follows X-linked inheritance, and is due to the deficiency of the enzyme hypoxanthine guanine phosphoribosyltransferase, which results in increased levels of phosphoribosylpyrophosphate. The latter is normally a rate-limiting chemical in the synthesis of purines. Excess amounts lead to an increased rate of purine synthesis and accumulation of uric acid and some of its metabolic precursors. The main effect is neurological, with uncontrolled movements, spasticity, mental retardation, and compulsive self-mutilation. Although drugs such as allopurinol, which inhibit uric acid formation, can lower uric acid levels, none is highly satisfactory.

### Adenosine Deaminase Deficiency

About half of all children with the autosomal recessive form of severe combined immunodeficiency with impaired B- and T-cell function (p. 173) have deficiency of the enzyme adenosine deaminase. Presentation is in infancy with recurrent viral and bacterial infections which, if untreated, soon cause death from overwhelming infection. The diagnosis is confirmed by deficient red blood cell adenosine deaminase activity. Bone marrow transplantation has been successful—even for the fetus in utero.

### Purine Nucleoside Phosphorylase Deficiency

A proportion of children susceptible to severe, recurrent, and potentially fatal viral infections with isolated impaired T-cell function have been shown to have a deficiency of the enzyme purine nucleoside phosphorylase. Treatment with irradiated red blood cells may result in a temporary improvement in immune function.

### Disorders of Pyrimidine and Nucleotide Metabolism

Within this group of disorders those affecting pyrimidine metabolism and nucleotide metabolism are rarer. The pyrimidine group includes orotic aciduria, and the nucleotide group includes Aicardi-Goutières syndrome.

#### Orotic Aciduria

In orotic aciduria, following autosomal recessive inheritance, some degree of learning disability occurs in addition to megaloblastic anemia, with hypochromic, microcytic circulating erythrocytes that are unresponsive to vitamin B12 and folic acid. Substantial quantities of orotic acid are present in the urine. The problems usually respond to pyrimidine replacement therapy, and thus most cases have a good prognosis. Some cases have additional features, including immune deficiencies and congenital malformations.

### Disorders of Porphyrin and Heme Metabolism

There are several different disorders of porphyrin metabolism that are from a deficiency of enzymes in the biosynthetic pathway of the iron-containing group in hemoglobin—heme (see Chapter 12) (Figure 18.11). They all follow autosomal dominant inheritance, with the exception of autosomal recessive congenital erythropoietic porphyria. This is because the enzymes are rate limiting (p. 20), so that haploinsufficiency results in clinical disease.

The different types of porphyria are variably associated with neurological or visceral involvement and cutaneous photosensitivity from an accumulation of the different porphyrin precursors in those organs. The porphyrias are divided into two types depending on whether the excess production of porphyrins occurs predominantly in the liver or in the erythropoietic system.

#### Hepatic Porphyrias

##### Acute Intermittent Porphyria

Acute intermittent porphyria is characterized by attacks of abdominal pain, weakness, vomiting, and mental disturbance in the form of confusion, emotional upset, or hallucinations. Even coma may occur, and women are more severely affected than

men, with symptoms sometimes associated with the menstrual cycle. Attacks can also be precipitated by the administration of certain drugs, such as exogenous steroids, anticonvulsants, and barbiturates. It is caused by a partial deficiency of the enzyme uroporphyrinogen I synthase leading to increased excretion of the porphyrin precursors porphobilinogen and  $\delta$ -aminolevulinic acid in urine. Direct gene testing is available.

##### Hereditary Coproporphyrria

In hereditary coproporphyrria, a related condition also inherited as a dominant trait, there is partial deficiency of the enzyme coproporphyrinogen oxidase. The disorder is clinically indistinguishable from acute intermittent porphyria, although approximately one-third of affected persons also have photosensitivity of the skin.

##### Porphyria Variegata

People with this form of porphyria, particularly prevalent in South African Afrikaners (p. 66), have variable skin photosensitivity with neurological and visceral features that can also be triggered by drugs. Increased fecal excretion of the porphyrin precursors protoporphyrin and co-protoporphyrin can be demonstrated and the disorder has been shown to be due to deficiency of the enzyme protoporphyrinogen oxidase.

#### Erythropoietic Porphyrias

##### Congenital Erythropoietic Porphyria

The main feature of congenital erythropoietic porphyria is an extreme photosensitivity with blistering of the skin leading to extensive scarring, to the extent that most affected people are unable to go out in normal daylight. In addition, many have a hemolytic anemia requiring regular blood transfusion and frequently splenectomy. Affected individuals have red-brown discoloration of the teeth, which show red fluorescence under ultraviolet light. Congenital erythropoietic porphyria is due to deficiency of the enzyme uroporphyrinogen III synthase.

##### Erythropoietic Protoporphyrria

Erythropoietic protoporphyrria is from a deficiency of the enzyme ferrochelatase, which is responsible for the insertion of ferrous iron into the porphyrin precursor to form heme. Affected persons have photosensitivity and sometimes develop chronic liver disease. Successful treatment of the photosensitivity has been reported with  $\beta$ -carotene.

### Disorders in the Metabolism of Trace Elements and Metals

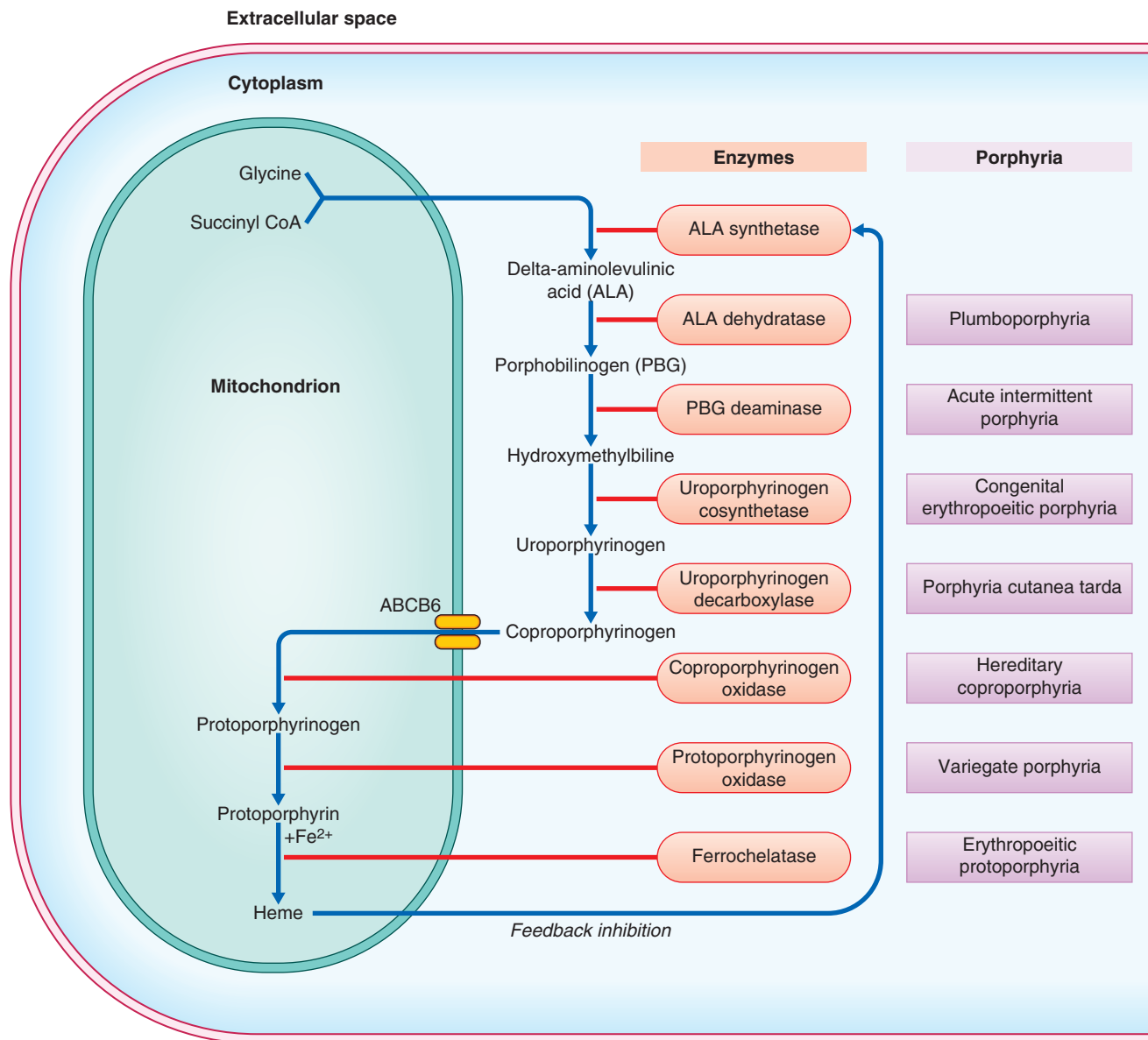
Within this group there are many rare entities but we focus on the disorders involving copper, iron, and zinc.

#### Disorders of Copper Metabolism

There are two distinct IEMs involving copper metabolism: Menkes disease and Wilson disease.

##### Menkes Disease

Menkes disease is an X-linked recessive disorder in which affected males present in the first few months of life with feeding difficulties, vomiting, and poor weight gain. Subsequently, hypotonia, seizures, and progressive neurological deterioration ensue, with death from recurrent respiratory infection usually occurring by the age of 3 years. A characteristic



**FIGURE 18.11** The porphyrin-heme biosynthetic pathway, highlighting the enzymes involved in the various different forms of porphyria.

feature is the hair, which lacks pigment, is kinky, and is brittle. This was noted to resemble the wool of sheep suffering from copper deficiency. Serum copper and ceruloplasmin levels are very low. Cloning of the gene for Menkes disease was facilitated through an affected female with an X-autosome translocation (p. 73) and revealed it to code for an ATPase cation transport protein for copper. Treatment regimens with different exogenous copper sources have had limited benefit to date.

### Wilson Disease

Autosomal recessive Wilson disease commonly presents in childhood or early adolescence with fits and abnormal neurological findings, including deteriorating coordination, involuntary movements, abnormal tone, dysarthria, dysphagia, and changes in behavior or frank psychiatric disturbance. Clinical examination may reveal 'Kayser-Fleischer rings', which are golden brown or greenish collarettes at the corneal margins.

Investigation can reveal the presence of abnormal liver function, progressing to cirrhosis.

High copper levels in the liver, decreased serum concentrations of the copper transport protein ceruloplasmin, and abnormal copper loading test results are suggestive of the diagnosis. The gene for Wilson disease was cloned on the basis of anticipated homology to the Menkes gene, and the gene product has been shown to be an ATPase cation transport protein involved in copper transfer from the hepatocytes to the biliary collecting system. Improvement of the neurological features can be achieved using the chelating agents such as D-penicillamine.

### Disorders of Iron Metabolism

#### Hemochromatosis

Hemochromatosis is a common disorder of iron metabolism that results in accumulation of iron. The liver is the most

commonly damaged tissue, with iron deposition leading to cirrhosis and liver failure. Patients are at increased risk of hepatocellular carcinoma. Other organs that may be affected include the pancreas, heart, pituitary gland, skin, and joints. The iron overload is easily treated by venesection, and this is very effective at reducing morbidity and mortality. The ratio of affected males to females is 5:1, and the disease is underdiagnosed in the general population but overdiagnosed in patients with secondary iron overload.

The *HFE* gene is close to the HLA region on chromosome 6p21. Between 85% and 100% (depending on population) of affected individuals are homozygous for the C282Y variant, and the carrier frequency in Northern Europe is approximately 1 in 10. The variant *H63D* is more common in the general population, and homozygosity is associated with only a modest increase in risk (approximately four-fold) of hemochromatosis. Compound heterozygosity for C282Y and *H63D* is associated with reduced penetrance—only 1% are thought likely to develop symptoms. Homozygosity for C282Y was thought to confer a high risk of hemochromatosis, suggesting that population screening would be useful since the iron overload is easily treated. However, population-based studies have suggested that the penetrance may be as low as 1%.

Hemochromatosis is a genetically heterogeneous disorder with mutations also reported in the transferrin receptor 2 (*TFR2*) gene and the *SLC40A1* gene which encodes ferroportin. In addition to the common recessive adult-onset form, there is a rare juvenile form with iron overload and organ failure before the age of 30 years, which is lethal if untreated. Neonatal hemochromatosis is severe and often of unknown etiology.

## Disorders of Zinc Metabolism

### Acrodermatitis Enteropathica

Zinc deficiency has long been recognized as the cause of this disorder which presents in infancy with dermatitis, diarrhea, and failure to thrive. Alopecia of the scalp, eyebrows, and eyelashes is usual, with the skin lesions being bullous. The condition is predisposed by homozygous or compound heterozygous mutations in the *SLC39A4* gene, which encodes a transmembrane protein that facilitates zinc uptake. Fortunately it is one of the treatable IEMs, requiring life-long dietary zinc supplementation.

### Peroxisomal Disorders

The peroxisomes are subcellular organelles bound by a single bilayer lipid membrane present in all cells; they are especially abundant in liver and renal parenchymal cells. The organelle matrix contains more than 40 enzymes that carry out a number of reactions involved in fatty-acid oxidation and cholesterol biosynthesis interacting with metabolic pathways outside the peroxisomes. The enzymes of the peroxisomal matrix are synthesized on the polyribosomes, enter the cytosol and are transferred into the peroxisomes.

These disorders are divided into those affecting peroxisome biogenesis, such as Zellweger syndrome, in which there are severely reduced numbers of peroxisomes in all cells, defects in oxidation, such as X-linked adrenoleukodystrophy, and chondrodysplasia punctata is included here.

### Zellweger Syndrome

Newborn infants with Zellweger syndrome present with hypotonia and weakness and have mildly dysmorphic facial



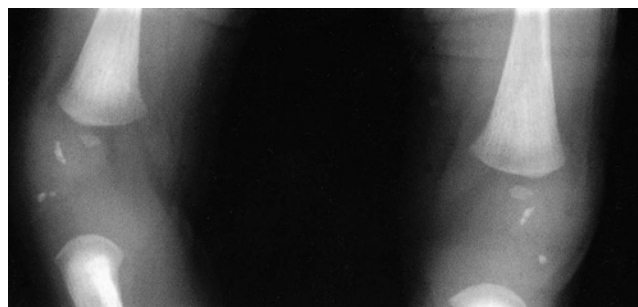
**FIGURE 18.12** Face of an infant with Zellweger syndrome showing a prominent forehead.

features (Figure 18.12), consisting of a prominent forehead and a large anterior fontanelle ('soft spot'). They may also have cataracts and an enlarged liver. They generally go on to have fits with developmental regression and usually die by 1 year of age. Investigations can reveal renal cysts and abnormal calcification in the cartilaginous growing ends of the long bones (Figure 18.13). There is a range of severity of this disorder, with different clinical diagnoses being given to the less severe types. The diagnosis can be confirmed by raised levels of plasma long-chain fatty acids. It is genetically heterogeneous, due to any one of several genes crucial to peroxisome biogenesis.

It is unusual for IEMs to give rise to a dysmorphic syndrome, but another is Smith-Lemli-Opitz syndrome (p. 107), an inborn error of cholesterol biosynthesis from a mutation in the sterol delta-7-reductase (*DHCR7*) gene, as well as some of the MPS group (p. 263).

### X-Linked Adrenoleukodystrophy

Males with the X-linked disorder adrenoleukodystrophy (ALD) classically present in late childhood with deteriorating school performance, though presentation may occur at any age and carrier females may sometimes develop symptoms; occasionally, there are no symptoms. Some males present in adult life with less severe neurological features and adrenal insufficiency, so-called adrenomyeloneuropathy. ALD has been shown to be associated with a deficiency of the enzyme very long-chain fatty acid CoA synthase, but is secondary to deficiency of a peroxisomal membrane protein, due to mutation in the *ABCD1* gene.



**FIGURE 18.13** Radiograph of the knee of a newborn infant with Zellweger syndrome showing abnormal punctate calcification of the distal femoral epiphyses.

Treatment of ALD with a diet that uses an oil with low levels of very long-chain fatty acids—'Lorenzo's oil'—has proved disappointing.

### Rhizomelic Chondrodysplasia Punctata

'Chondrodysplasia punctata' describes the particular radiological feature of bony stippling, or punctate calcifications, usually around the joints, in the early newborn period, and there are a variety of causes. Rhizomelic chondrodysplasia punctata type 1 (RCDP1), however, is a specific entity and a disorder of peroxisome biogenesis. The proximal humerus and sometimes femur are relatively short (rhizomelia), and coronal clefts occur in the vertebral bodies. Cataracts are usually present at birth or appear soon afterwards. Growth deficiency ensues, intellectual disability is severe, and seizures usually develop. Most children succumb by 10 years, some much earlier. A milder form does occur, often consisting of congenital cataracts, minimal skeletal problems, and much less severe intellectual disability. Biochemically, plasmalogens are deficient in red blood cells, phytanic acid is elevated in plasma, and very long chain fatty acids are normal. The sole mutated gene associated with RCDP1 is *PEX7*, encoding the receptor for a subset of peroxisomal matrix enzymes.

### Disorders of Fatty Acid and Ketone Body Metabolism

This group of disorders includes the various defects in carnitine transport and carnitine cycle. The carnitine cycle is a biochemical pathway required for the transport of long-chain fatty acids into the mitochondrial matrix, and those less than 10 carbons in length are then activated to form acyl-CoA esters. The carnitine cycle is one part of the pathway of mitochondrial  $\beta$ -oxidation that plays a major role in energy production, especially during periods of fasting. Carnitine deficiency is a secondary feature of the  $\beta$ -oxidation disorders, with the exception of the carnitine transport defect where it is primary, and this rare condition responds dramatically to carnitine replacement. The more common fatty-acid oxidation disorders are outlined—the conditions due to faulty 'chain acyl CoA dehydrogenase' enzymes—which can be broadly grouped under disorders of mitochondrial function.

#### Disorders of Mitochondrial Fatty Acid Oxidation

##### Medium-Chain Acyl-CoA Dehydrogenase (MCAD) Deficiency

MCAD deficiency is the most common of this group of disorders, presenting most frequently as episodic hypoketotic hypoglycemia provoked by fasting. The onset is often in the first 2 years of life and, tragically, is occasionally fatal, resembling sudden infant death syndrome. Management rests on maintaining adequate caloric intake and avoidance of fasting, which can be challenging in young children with intercurrent illnesses. An autosomal recessive disorder, 90% of alleles result from a single point mutation, and neonatal population screening is now routine in many countries.

##### Long-Chain and Short-Chain Acyl-CoA, and Long-Chain 3-Hydroxyacyl-CoA Dehydrogenase Deficiencies

These rare conditions, also autosomal recessive, present early in life with a variable combination of skeletal features and

cardiomyopathy, hepatocellular dysfunction with hepatomegaly, and encephalopathy. Treatment revolves around nutritional maintenance and avoidance of fasting, but is not very rewarding in short-chain acyl-CoA deficiencies.

##### Multiple Acyl CoA Dehydrogenase Deficiency, or Glutaric Aciduria II

Type II glutaric aciduria is variable, with two severe forms having neonatal onset, one of these including urogenital anomalies. In both of these severe types, hypotonia, hepatomegaly, metabolic acidosis, and hypoketotic hypoglycemia occur. The late-onset form may present in early childhood, rather than the neonatal period, with failure to thrive, metabolic acidosis, hypoglycemia, and encephalopathy. Treatment of the severe forms is supportive only, but in the milder form riboflavin, carnitine, and diets low in protein and fat have been more successful.

### Disorders of Energy Metabolism

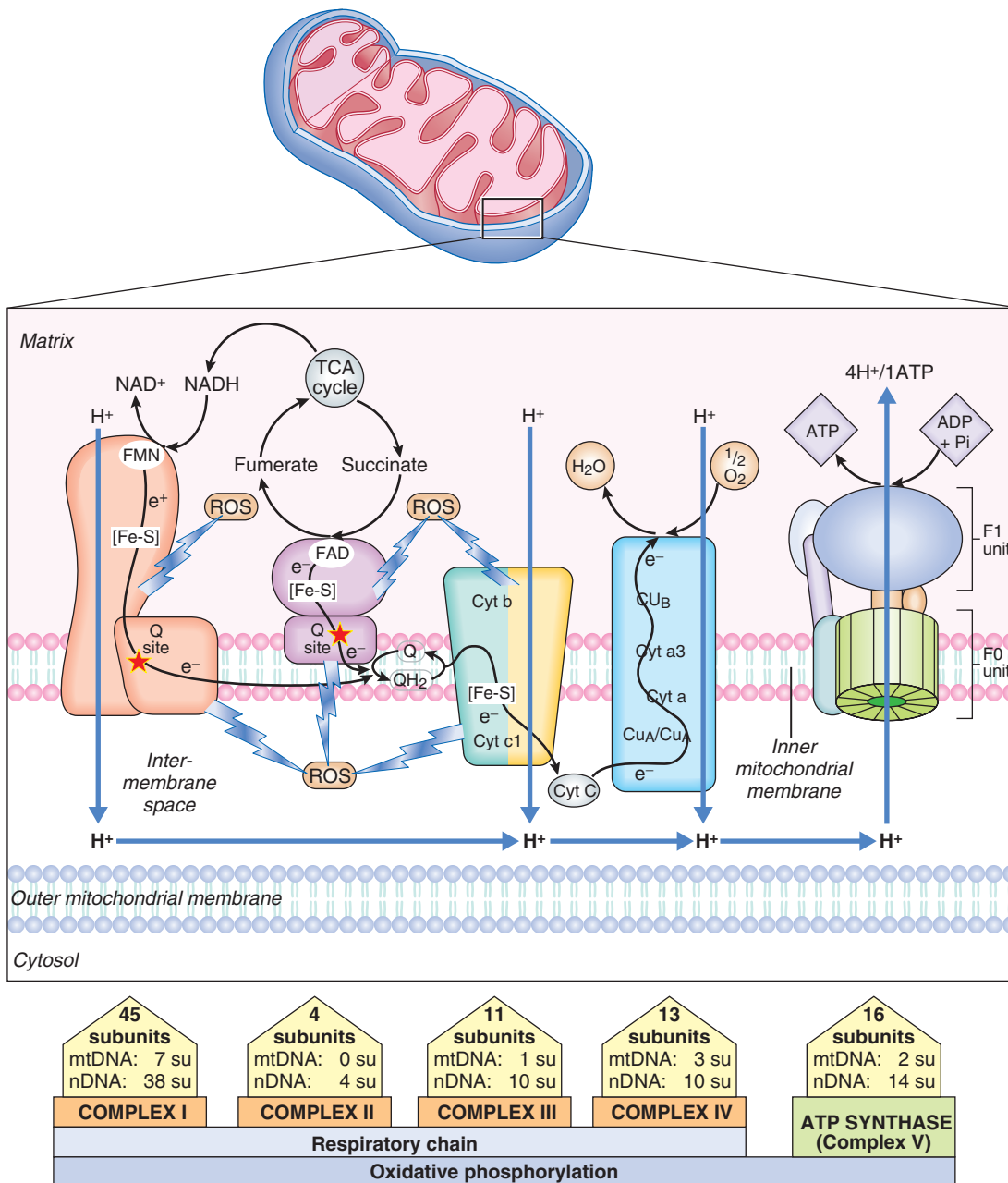
This broad group of conditions includes the various disorders affecting the pyruvate dehydrogenase complex, which includes an X-linked form, as well as the vast and important disorders of the mitochondrial respiratory chain.

#### Mitochondrial Respiratory Chain Disorders

Mitochondrial disease was first identified in 1962 in a patient whose mitochondria showed structural abnormalities and loss of coupling between oxidation and phosphorylation, although it was not until 20 years later that the relevance of mutated mitochondrial DNA (mtDNA) to human disease began to be appreciated. The small circular double-stranded mtDNA (see [Figure 2.7, p. 14](#)) contains genes coding for ribosomal RNA (rRNA) production and various transfer RNAs (tRNA) required for mitochondrial protein biosynthesis, as well as some of the proteins involved in electron transport. There are 5523 codons and a total of 37 gene products. Guanine and cytosine nucleotides are asymmetrically distributed between the two mtDNA strands—the guanine-rich strand being called the heavy (H) strand and the cytosine-rich the light (L) strand. Replication and transcription is controlled by a 1122-bp sequence of mtDNA known as the displacement loop (D-loop). Oxidative phosphorylation (OXPHOS) is the biochemical process responsible for generating much of the ATP required for cellular energy. The process is mediated by five intramitochondrial enzyme complexes, referred to as complexes I–V, and the mtDNA encodes 13 OXPHOS subunits, 22 tRNAs, and two rRNAs.

The 'complexes' are aptly named ([Figure 18.14](#)). Analysis of complex I, for example, has revealed approximately 45 different subunits thus far—38 nuclear-encoded and seven mitochondrial-encoded subunits—mutations in any of which can cause the disorder. Most affected individuals have a phenotype of Leber hereditary optic neuropathy (LHON) or Leigh syndrome. Complex V comprises 12 or 13 subunits, of which two, ATPase 6 and 8, are encoded by mtDNA. Maximal activity of complex V appears to require tight linking with cardiolipin (see Barth syndrome, [p. 260](#)), encoded by nuclear DNA.

Because most mitochondrial proteins, including subunits involved in electron transport, are encoded by nuclear genes, these most often follow autosomal recessive inheritance, but autosomal dominant and X-linked forms also occur. As with other metabolic autosomal recessive diseases, disorders



**FIGURE 18.14** Representation of the mitochondrial respiratory chain complexes and the oxidative phosphorylation system. The four complexes of the respiratory chain and the ATP synthase (complex V) are schematized and the electron/proton pathways along these complexes are indicated. ROS, reactive oxygen species; TCA, tricarboxylic (citric) acid cycle.

resulting from mutations in these genes tend to breed true. However, the disorders resulting from mutations in mtDNA are extremely variable owing to the phenomenon of heteroplasmy (see Figure 6.30, p. 81). The clinical features are mainly a combination of neurological signs—encephalopathy, dementia, ataxia, dystonia, neuropathy, and seizures—and myopathic signs—hypotonia, weakness, and cardiomyopathy with conduction defects. Other symptoms and signs may include deafness, diabetes mellitus, retinal pigmentation, and acidosis may occur. The clinical manifestations are so variable that a mitochondrial cytopathy should be considered as a possibility at any age when the presenting illness has a neurological or myopathic component. Several distinct clinical entities have been determined

and, although some of them overlap considerably, there is a degree of genotype-phenotype correlation.

### Myoclonic Epilepsy and Ragged Red Fiber Disease (MERRF)

MERRF disease was first described in 1973 and so called because Gomori’s trichrome staining of muscle revealed abnormal deposits of mitochondria as ‘ragged red’. In 1988 it was determined that the condition was maternally inherited. The classic picture is of progressive myoclonic epilepsy, myopathy, and slowly progressive dementia. Optic atrophy is frequently present and the electroencephalogram is characteristically abnormal. Post-mortem brain examination reveals widespread



neurodegeneration. In 1990 it was reported that MERRF results from a point mutation in the gene for lysine tRNA.

### Mitochondrial Encephalomyopathy, Lactic Acidosis, and Stroke-Like Episodes (MELAS)

First delineated in 1984, this extremely variable condition is now recognized as one of the most common mitochondrial disorders. Short stature may be a feature, but it is stroke-like episodes that mark out this particular disorder, although these episodes do not necessarily occur in all affected family members. When they do occur, they may manifest as vomiting, headache, or visual disturbance, and sometimes lead to transient hemiplegia or hemianopia. A common presenting feature of MELAS is type 2 diabetes mellitus, and a sensorineural hearing loss may also occur (described as maternally inherited diabetes and deafness). These latter clinical features are associated with the most common mutation, an A > G substitution at nucleotide m.3243, which affects tRNA leucine<sup>UUR</sup>. This is found in approximately 80% of patients, followed by a T > C transition at nucleotide m.3271, also affecting tRNA leucine<sup>UUR</sup>.

### Neurodegeneration, Ataxia, and Retinitis Pigmentosa (NARP)

The early presenting feature is night blindness, which may be followed years later by neurological symptoms. Dementia may occur in older patients, but seizures can present at almost any age and younger patients show developmental delay. The majority of cases are due to a single mutation—the T > G substitution at nucleotide m.8993, which occurs in the coding region of subunit 6 of ATPase. This change is often referred to as the NARP mutation.

### Leigh Disease

This condition is characterized by its neuropathology, consisting of typical spongiform lesions of the basal ganglia, thalamus, substantia nigra, and tegmental brainstem. In its severe form, death occurs in infancy or early childhood, and it was in such a patient that the m.8993T > G NARP mutation was first identified. In effect, therefore, one form of Leigh disease is simply a severe form of NARP, and higher proportions of mutant mtDNA have been reported in these cases. However, variability is again sometimes marked and the author knows one family in which a mother, whose daughter died in early childhood, was found to have low levels of the 8993 mutation and her only symptom was slow recovery from a general anesthetic.

The same or very similar pathology, and a similar clinical course, has now been described in patients with different molecular defects. Cytochrome *c* deficiency has been reported in a number of patients and some of these have been shown to have mutations in *SURF1*, a nuclear gene. These cases follow autosomal recessive inheritance. Leigh disease is therefore genetically heterogeneous, including an X-linked form (*NDUFA1* gene).

### Leber Hereditary Optic Neuropathy (LHON)

LHON was the first human disease to be shown to result from an mtDNA point mutation; about 18 different mutations have

now been described. The most common mutation occurs at nucleotide m.11,778 (*MTND4*), accounting for up to 70% of cases in Europe and more than 90% of cases in Japan. It presents with acute, or subacute, loss of central visual acuity without pain, which typically occurs between 12 and 30 years of age. Males in affected pedigrees are much more likely to develop visual loss than females. In some LHON pedigrees, additional neurological problems occur.

## Prenatal Diagnosis of Inborn Errors of Metabolism

For the majority of inborn errors of metabolism in which an abnormal or deficient gene product can be identified, prenatal diagnosis is possible. Biochemical analysis of cultured amniocytes obtained at mid-trimester amniocentesis is possible but has largely given way to earlier testing using direct or cultured chorionic villi (CV), which allows a diagnosis to be made by 12 to 14 weeks' gestation (p. 305). For many conditions a biochemical analysis on cultured CV tissue is the appropriate test but, increasingly, direct mutation analysis has superseded biochemical analysis. This avoids the inherent delay of culturing CV tissue and is of particular value for inborn errors for which the biochemical basis is not clearly identified, or where the enzyme is not expressed in amniocytes or CV.

Prenatal diagnosis of mitochondrial disorders from mtDNA mutations presents particular difficulties because of the problem of heteroplasmy and the inability to predict the outcome for any result obtained, whether positive or negative for the mutation in question. This presents challenging counseling issues and also raises consideration of other reproductive options, such as ovum donation. The possibility of donated mitochondria using nuclear transfer technology is becoming a reality (see Chapter 20).

## FURTHER READING

- Applegarth, D.A., Toone, J.R., Lowry, R.B., 2000. Incidence of inborn errors of metabolism in British Columbia, 1969–1996. *Pediatrics* 105, e10.
- A large population study of IEMs, providing good epidemiological data.*
- Garrod, A.E., 1908. Inborn errors of metabolism. *Lancet* ii, 1–7, 73–79, 142–148, 214–220.
- Reports of the first inborn errors of metabolism.*
- Nyhan, W.L., Ozand, P.T., 1998. *Atlas of metabolic diseases*. Chapman & Hall, London.
- A detailed text but very readable and full of excellent illustrations and clinical images.*
- Rimoin, D.L., Connor, J.M., Pyeritz, R.E., Korf, B.R., 2001. *Principles and practice of medical genetics*, fourth ed. Churchill Livingstone, Edinburgh.
- The section on metabolic disorders includes 13 chapters covering in succinct detail the various groups of metabolic disorders.*
- Scriver, C.R., Beaudet, A.L., Sly, W.S., Valle, D., 2001. *The metabolic and molecular bases of inherited disease*, eighth ed. McGraw Hill, New York.
- A huge multi-author three-volume comprehensive detailed text on IEMs. This has now become: The Online Metabolic and Molecular Bases of Inherited Disease. David Valle (Editor-in-Chief), et al* <http://ommbid.mhmedical.com/book.aspx?bookid=971>

## ELEMENTS

- 1 Metabolic processes in all species occur in steps, each being controlled by a particular enzyme which is the product of a specific gene, leading to the one gene–one enzyme concept.

A few are inherited as autosomal dominant disorders involving rate-limiting enzymes, cell-surface receptors, or multimeric enzymes through haploinsufficiency or dominant negative mutations.
- 2 A block in a metabolic pathway results in the accumulation of metabolic intermediates and/or a deficiency of the end-product of the particular metabolic pathway concerned, a so-called inborn error of metabolism.
- 3 The majority of the inborn errors of metabolism are inherited as autosomal recessive or X-linked recessive traits.
- 4 A number of the inborn errors of metabolism can be screened for in the newborn period and treated successfully by dietary restriction or supplementation.
- 5 Prenatal diagnosis of many of the inborn errors of metabolism is possible by either conventional biochemical methods or direct mutation analysis.

# Mainstream Monogenic Disorders

More than 10,000 single-gene, or monogenic, traits and disorders are known. Most are individually rare, but together they affect between 1% and 2% of the general population at any one time. The diagnosis, investigation, and family management of these disorders present the major workload challenge in clinical genetics. Many uncommon or rare monogenic disorders have been covered in other Chapters, e.g., 6, 9, 12, 13 and 14, but here we attempt an overview of those conditions which are traditionally better known to physicians in mainstream medicine. For many of these, as with rare disorders, there have been significant genetic and clinical advances in recent times.

## Neurological Disorders

Adult onset inherited neurological disorders have lent themselves to genetic research by virtue of the fact that large affected families, with normal biological fitness, are often encountered, thus greatly facilitating successful linkage analysis and subsequent gene identification—many of these disorders were among the first to yield their secrets in the molecular genetics era.

### Huntington Disease

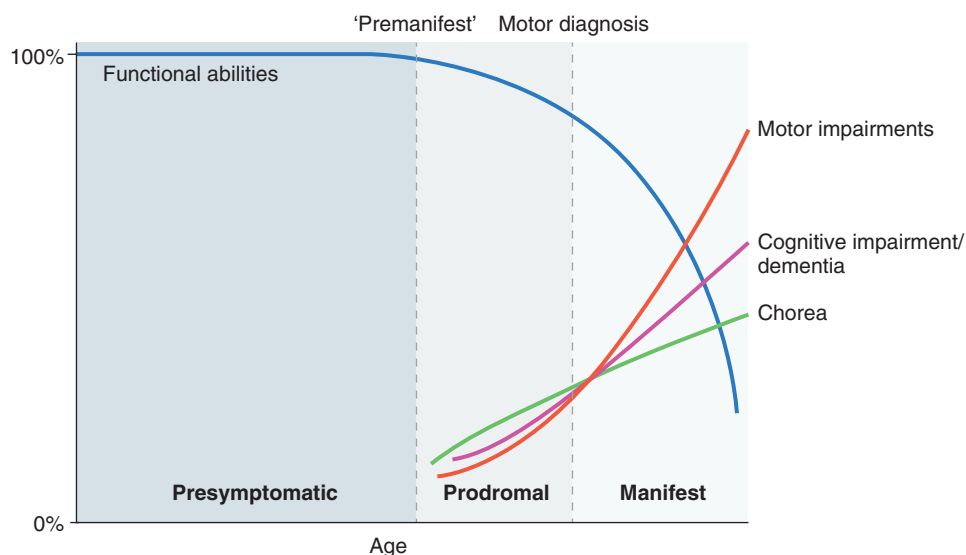
Huntington disease (HD) derives its eponymous title from Dr. George Huntington, who described multiple affected individuals in a large North American kindred in 1872. His paper, published in the Philadelphia journal, *The Medical and Surgical Reporter*, gave a graphic description of the progressive neuro-

logical disability that continues to evoke apprehension and fear. The natural history is characterized by slowly progressive selective cell death in the central nervous system, and currently there is no effective treatment or cure. The prevalence in most parts of the world is approximately 1:10,000, although higher in some areas, such as Tasmania and the Lake Maracaibo region of Venezuela. The onset is mostly between 30 and 50 years, but it can start at virtually any age, including a rare juvenile form with different clinical features. The variable age of onset has been explained, at least in part, by the discovery of the underlying molecular defect.

### Clinical Features

The disease is characterized by a slowly progressive movement disorder—chorea—and insidious impairment of intellectual function with psychiatric disturbance and eventual dementia (Figure 19.1). The mean duration of the illness is between 15 and 25 years. Chorea movements are involuntary, consisting of facial grimacing, twitching of the face and limbs, folding of the arms, crossing of the legs, and progressively unsteady gait and unclear speech.

Intellectual changes in the early stages of HD include memory impairment and poor concentration span. Anxiety and panic attacks, mood changes and depression, aggressive behavior, paranoia, irrationality, increased libido, and alcohol abuse can also occur. There is a gradual deterioration in intellectual function, leading eventually to total incapacitation and dementia.



**FIGURE 19.1** The natural history of Huntington Disease. Clinical diagnosis is usually made on the basis of the movement disorder, i.e., chorea. However, other neurological problems are also typically part of the prodromal phase.

Up to 5% of HD cases present before the age of 20 years, when the term **juvenile HD** is used, and instead of chorea there is rigidity, with slowing of voluntary movement and clumsiness. A decline in school performance heralds the onset of a severe progressive dementia, often in association with epileptic seizures. The average duration of the illness is 10 to 15 years.

## Genetics

HD follows autosomal dominant (AD) inheritance with a variable age of onset, almost full penetrance, and demonstrates anticipation (see [Chapter 6, p. 75](#)), sometimes markedly so through *paternal* transmission, hence sometimes giving rise to juvenile HD. The new mutation rate is very low.

HD was one of the first disorders to be mapped by linkage analysis, greatly assisted by studying the huge Venezuelan pedigree, and the nature of the mutation discovered in 1993. This is a highly polymorphic CAG (polyglutamine) trinucleotide repeat sequence located in the 5' region. The messenger RNA (mRNA) codes for a protein of approximately 350 kDa, known as *huntingtin* (*HTT*; aka *IT15*). *HTT* is expressed in many different cells throughout the central nervous system, as well as other tissues. Four categories of CAG repeat length are recognized according to their clinical implications ([Table 19.1](#)).

**Normal alleles** contain 26 or fewer CAG repeats, are not associated with disease manifestations and are stable in meiosis. Allele sizes of 27 to 35 CAG repeats do not cause disease but occasionally show meiotic instability with a potential to increase or decrease in size, and are therefore **mutable**, constituting the reservoir from which larger, pathogenic, alleles arise. When an apparently new mutation case of HD occurs, it usually transpires that the father carries a mutable allele, and there is evidence that the expansion occurs on the background of a particular haplotype DNA pattern, suggesting that certain haplotypes are more mutable than others.

**Reduced penetrance alleles** consist of 36 to 39 CAG repeats. These are associated with either late-onset disease or sometimes complete absence of disease expression, i.e., non-penetrance.

**Disease alleles** contain 40 or more CAG repeats. These are invariably associated with disease, though sometimes late in

onset. Statistically, there is a direct relationship between length of CAG repeat and disease expression, with the average age of onset for sizes of 40, 45, and 50 being 57, 37, and 26 years, respectively. Most affected adults have repeat sizes of between 36 and 50, whereas juvenile cases often have an expansion greater than 55 repeats.

## Parent of Origin Effect

The risk to offspring is 50% regardless of whether the affected parent is male or female, according to autosomal dominant inheritance. However, for reasons that are not clear, meiotic instability is greater in spermatogenesis than oogenesis. This is reflected in anticipation, occurring mainly when the mutant allele is transmitted by a male. Juveniles with the rigid form of HD have almost always inherited the mutant allele from their more mildly affected father.

Explanations for this include the possibility that expansion is caused by **slippage** ([p. 19](#)) of DNA polymerase, simply reflecting the number of mitoses undergone during gametogenesis ([p. 32](#)). An alternative possibility is based on the observation that *HTT* is expressed in oocytes, so that there could be selection against oocytes with large expansions as a consequence of preferential apoptosis.

## Predictive and Prenatal Testing

HD has provided the paradigm for predictive presymptomatic testing in inherited disease and is part of routine clinical genetic practice, but there is universal agreement that this should be offered only as part of a careful counseling package. Experience indicates that more women than men opt for this, and the psychological disturbance in those given positive results is low. Some 60% of candidates test negative (i.e., they receive good news), the reasons for the departure from the expected 50% not being clear, though it could be that more of the 'worried well' seek testing while some of those destined to develop HD already have some blunting of their insight before being obviously symptomatic.

Prenatal diagnosis, as well as preimplantation genetic diagnosis (see [Chapter 20, p. 313](#)), is possible, although only approximately 25 such tests are performed in the United Kingdom annually. Considerable emotional and ethical issues accompany termination of pregnancy—the condition is late in onset and the couple must consider the possibility of effective therapy being available in the decades ahead, which is an area of intense research activity.

## The Hereditary Ataxias

This is a hugely diverse group of progressive conditions characterized by a poorly coordinated, wide-based gait, often accompanied by dysarthria, abnormal eye movements (nystagmus) and also poor upper limb coordination. Abnormal cerebellar structure and/or function is usually present. There are many non-genetic causes of ataxia but the hereditary forms may follow any of the main patterns of inheritance—AD, autosomal recessive (AR), and X-linked (XL). Mitochondrial disorders may also feature ataxia among other clinical signs and symptoms. Here we cover the most common disorders only.

## Spinocerebellar Ataxias (SCA)

This large group of disorders are essentially equivalent to the hereditary ataxias following AD inheritance (even though

**Table 19.1** Comparison of Genetic Aspects of Huntington Disease and Myotonic Dystrophy

	Huntington Disease	Myotonic Dystrophy
Inheritance	Autosomal dominant	Autosomal dominant
Chromosome locus	4p16.3	19q13.3
Trinucleotide repeat	CAG in 5' translated region	CTG in 3' untranslated region
Repeat sizes	Normal ≤26 Mutable 27–35 Reduced penetrance 36–39 Fully penetrant ≥40	Normal <37 Full mutation 50–2000+
Protein product	Huntingtin	MD protein kinase (DMPK)
Early-onset form	Juvenile Usually paternally transmitted	Congenital Usually maternally transmitted

DMPK, Dystrophin myotonia protein kinase; MD, myotonic dystrophy.

recessively inherited forms are described) and approximately 40 different types are recognized, based on the specific genes that are implicated, or in some cases the gene locus only. Prevalence may be up to 5:100,000. The onset is usually sometime in adulthood and the different types can be difficult or impossible to distinguish clinically. Cognitive decline and dementia occur in several forms and in some there are particular features, e.g., visual loss with retinopathy in SCA type 7 (*ATXN7* gene), which also tends to be rapidly progressive and life-shortening. In most surveys SCA type 3 (*ATXN3* gene), also known as Machado-Joseph disease, is the most commonly encountered form and also tends to be life-shortening. Some types, e.g., SCA1, 2, and 4, may manifest features of peripheral neuropathy. One rare type of ataxia that mimics HD and strictly speaking is not classified as a subtype of SCA, is dentatorubral-pallidolysian atrophy (DRPLA), due to mutated *ATN1*.

### Genetics

The majority of SCA types, and including DRPLA, like HD are due to particular trinucleotide expansions in the coding regions of their respective genes, in most cases the CAG triplet (see Table 2.5). As such they may demonstrate anticipation over several generations (in SCA7 and DRPLA the CAG repeat is particularly unstable), potentially more marked as a result of *paternal* transmission.

### Episodic Ataxias (EA)

These conditions follow AD inheritance and are characterized by intermittent periods, or paroxysms, of unsteady gait, perhaps lasting several hours, with nystagmus and dysarthria. Approximately seven subtypes are currently recognized, EA1 and EA2 being due to mutations in *KCNA1* and *CACNA1A* respectively. The symptom of vertigo in EA2 may distinguish it clinically from EA1, as well as the finding of cerebellar vermis hypoplasia on MRI scan. In both cases the finding of a pathogenic heterozygous variant will confirm the diagnosis, and *CACNA1A* is the same gene implicated in SCA6 as well as familial hemiplegic migraine; indeed, aspects of these clinical phenotypes may be seen among affected members of the same family.

### Friedreich Ataxia (FRDA)

Of the many ataxias following AR inheritance Friedreich ataxia is probably the best known as well as being the most common but there are a variety of other disorders that may need to be considered at presentation, including the various forms of Joubert and pontocerebellar syndromes, metabolic diseases such as disorders of glycosylation and peroxisomal biogenesis, and ataxia telangiectasia. In adulthood a variety of rare ataxias following AR inheritance may be encountered including cerebrotendinous xanthomatosis characterized by the finding of xanthoma lesions, e.g., around the achilles tendon.

In FRDA the onset is usually in late childhood or early adolescence and a slowly progressive ataxia ensues. There is absence of lower limb reflexes (in contrast to the finding in SCA), and loss of position and vibration sense. Approximately two-thirds of cases go on to develop hypertrophic cardiomyopathy (perhaps 'dilated' later on) and one-third, diabetes mellitus. Dysarthria, dysphagia, and scoliosis are all common features, as well as autonomic dysfunction. Optic nerve atrophy may be seen in approximately 25% of cases.

### Genetics

FDRA is another triplet repeat disease, but in this case with GAA (see Table 2.5) in an intronic region of the *FXN* gene. Pathogenic alleles number in the hundreds and as a recessively inherited condition anticipation is not seen. However, there is broad inverse correlation of the age of onset with the numbers of GAA repeats, though not to the extent that the age of onset or severity can be predicted from the molecular findings.

### Inherited Peripheral Neuropathies

This is another group of conditions that has become increasingly complex from a genetic viewpoint and incorporates hereditary sensory neuropathies, various forms of **familial dysautonomia** (FD), as well as the better known hereditary motor and sensory neuropathies (HMSN), which are synonymous with Charcot-Marie-Tooth (CMT) disease. In addition, the astute clinician has to be very aware that peripheral neuropathy symptoms can be a presenting feature of other disorders, e.g., neurofibromatosis type 2 and metabolic disorders such as Fabry disease (p. 265), X-linked adrenoleukodystrophy (p. 268), and others.

### Hereditary Motor and Sensory Neuropathies/Charcot-Marie-Tooth Disease

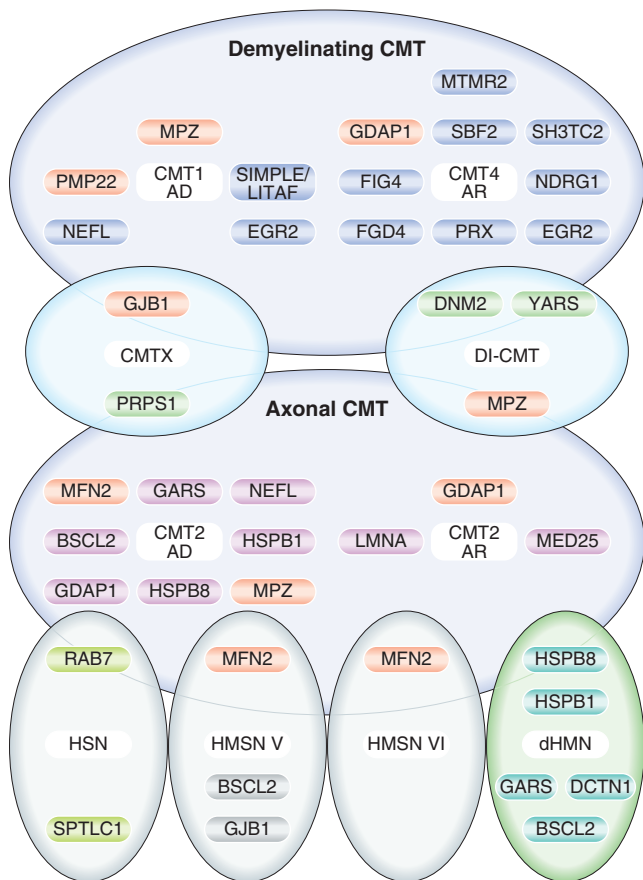
HMSN, also known as **CMT disease** and **peroneal muscular atrophy**, are clinically and genetically heterogeneous with at least 40 different genes or loci identified (Figure 19.2) but all basically characterized by slowly progressive distal muscle weakness and wasting. Their overall incidence is approximately 1:3000.

Clinical classification on the basis of motor nerve conduction velocity (MNCV) is still useful. HMSN type 1 is '**demyelinating**', accompanied by hypertrophic changes with 'onion bulb' formation if a nerve biopsy is undertaken, and the MNCV is reduced to 5–30 m/sec (normal: >40–45 m/sec). HMSN type 2 is '**axonal**' (non-demyelinating) and the MNCV is normal or only slightly reduced, in the range 35–48 m/sec, and a nerve biopsy shows axonal degeneration. Whilst many patients can be categorized as type 1 or 2 on this basis, some genetic varieties of HMSN demonstrate a mixed picture and/or variability between different affected family members.

### Clinical Features

In autosomal dominant HMSN1a—the most common form—the onset occurs as slowly progressive distal muscle weakness and wasting in the lower limbs between the ages of 10 and 30 years, followed later by the upper limbs in many patients, often with associated ataxia and tremor. The appearance of the lower limbs has been likened to that of an 'inverted champagne bottle' (Figure 19.3) and peripheral nerve reflexes are absent or greatly diminished. Over time, locomotion becomes more difficult and the feet tend to show exaggeration of their normal arch, known as 'pes cavus'. Many patients may retain reasonable muscle strength and not be too seriously disabled, though others may be significantly restricted. Vision, hearing, and intellect are not impaired. Palpable thickening of peripheral nerves can sometimes be detected.

The clinical features in other forms of HMSN are similar but may differ in the age of onset, rate of progression, and presence of other neurological involvement. For example, the onset in HMSN2 is usually later and the disease course milder than type 1, and peripheral reflexes may be relatively preserved.



**FIGURE 19.2** The different forms of Charcot-Marie-Tooth (CMT) disease, or hereditary motor and sensory neuropathy (HMSN), and their associated genes, highlighting the clinical and genetic overlap. The most commonly encountered genes are highlighted in red. *dHMN*, Distal hereditary motor neuropathy; *DI*, dominant intermediate; *HSN*, hereditary sensory neuropathy. (Modified from Pareyson D, Marchesi C 2009. *Diagnosis, natural history, and management of Charcot-Marie-Tooth disease*. *Lancet Neurol* 8: 654–667.)

In some of the rarer forms of HMSN additional neurological features, e.g., optic atrophy, may be present.

### Genetics

HMSN may show autosomal dominant, autosomal recessive, or X-linked inheritance, although autosomal dominant forms are by far the most common. Rarely, mitochondrial inheritance may apply, e.g., in NARP syndrome (p. 271). Some 75% of cases of HMSN1 (type a) are due to a DNA **duplication** of 1.5 Mb on chromosome 17p that harbors the peripheral myelin protein-22 (*PMP22*) gene, whose glycoprotein product is present in the myelin membranes of peripheral nerves where it helps to arrest Schwann cell division. HMSN1a is therefore the result of a *PMP22* dosage effect, and the duplication is generated by misalignment and subsequent recombination between homologous sequences that flank the *PMP22* gene (Figure 19.4); this event usually occurs in male gametogenesis. The reciprocal **deletion** product of this misaligned recombination event, giving rise to haploinsufficiency, causes a relatively mild disorder known as **hereditary neuropathy with liability to pressure palsies**. Minor nerve trauma, such as pressure from prolonged sitting on a long-haul flight, causes focal numbness

and weakness. The same misalignment recombination mechanism occurs in Hb Lepore and anti-Lepore (see Figure 12.3; p. 155), congenital adrenal hyperplasia (p. 261), and deletion 22q11 syndrome (p. 245), to name but a few.

In a small proportion of HMSN1 cases another myelin protein, **myelin protein zero** (encoded by the *MPZ* gene) is implicated. This plays a crucial role as an adhesion molecule in the compaction of myelin in peripheral nerves and in fact leads to a mixed, or intermediate, type of demyelination and axonal neuropathy. The many other genetic varieties of HMSN1 are rare.

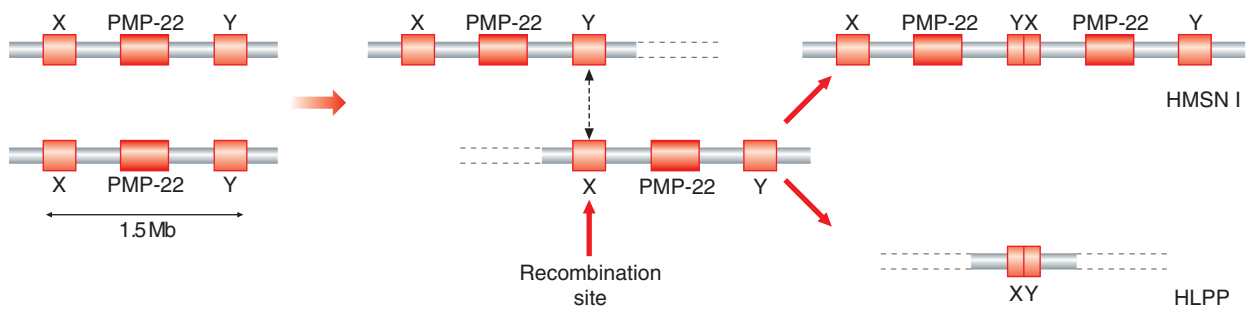
HMSN2 is genetically heterogeneous and a genetic diagnosis is achieved less often compared with type 1. Some 20% of cases are due to defective Mitofusin 2 (*MFN2*), a nuclear gene producing abnormal mitochondrial fusion/fission (HMSN2a). The other genes seen occasionally in CMT2 are *NEFL*, *GDAP1*, *GARS*, and *YARS*, and intermediate demyelinating/axonal effects are again seen.

HMSN type 4, or *CMT4*, is a group of rare demyelinating and axonal peripheral neuropathies that are set apart from the others purely by the fact that they follow AR inheritance. Otherwise they may be clinically indistinguishable and their causation determined only by genetic testing.

The main X-linked form of HMSN, *CMTX1*, may account for 5% to 10% of HMSN overall, is due to mutated *GJB1* (previously *Connexin 32*), and shows XL *dominant* inheritance.



**FIGURE 19.3** Lower limbs of a male with hereditary motor and sensory neuropathy showing severe muscle wasting below the knees.



**FIGURE 19.4** Mechanism by which misalignment and recombination with unequal crossing over lead to formation of the duplication and deletion that cause hereditary motor and sensory neuropathy type I (HMSN I) and hereditary neuropathy with liability to pressure palsies (HNPP). X and Y represent homologous sequences flanking the *PMP22* gene.

Both sexes are usually affected, though males have typical features with females relatively mildly affected.

### Hereditary Sensory and Autonomic Neuropathies (HSAN)

These are a group of axonal neuropathies, usually following AD inheritance, where symptoms are primarily sensory with little or no motor involvement. The most common form, HSAN1, is due to mutations in *SPTLC1* and affected patients describe very unpleasant and disabling ‘burning feet’, and may develop ulceration on pressure points, and potentially neuro-pathic arthropathy. Another gene implicated is *ATL3*.

The HSAN group includes **familial dysautonomia (FD)**, or HSAN III, which is an early onset, debilitating, and progressive condition whereby the development and survival of sensory, sympathetic, and parasympathetic neurons is greatly affected. The diagnosis can be difficult as affected individuals have gastrointestinal dysfunction with vomiting crises, recurrent pneumonia, impaired pain and temperature sensitivity, and cardiovascular instability. Life expectancy is greatly reduced but early diagnosis and supportive treatment improves the outlook. It is recessively inherited, due to mutated *IKBKAP*, and more common in Ashkenazi Jews, where one founder mutation accounts for the majority of cases.

**HSAN IV is congenital insensitivity to pain with anhidrosis (CIPA)**, which may closely resemble FD. Typically, high fevers occur which may be life-threatening and multiple unrecognized injuries can result in mutilating effects. Also recessively inherited, it is due to mutated *NTRK1*.

### Hereditary Spastic Paraparesis (HSP)

Also known as hereditary spastic paraplegia, this large group of disorders (nearly 60 different known varieties to date) is characterized by lower limb spasticity and weakness, the onset varying from infancy to adulthood, and both progressive and non-progressive forms exist. The spasticity and gait closely resemble the pattern seen in spastic diplegic cerebral palsy. In ‘uncomplicated’ cases the effects are limited to the lower limbs with hyperreflexia, though urinary urgency and paresthesia may occur. No cognitive impairment or dysarthria is present. Where pathology is established the cause is axonal degeneration affecting the distal ends of the corticospinal tracts. In ‘complicated’ forms a variety of neurological features may be seen, including cognitive decline, seizures, and peripheral neuropathy.

In clinical practice the most commonly encountered forms of HSP follow AD inheritance with the *SPAST (SPG4)*, *ATL1 (SPG3A)*, and *REEPI (SPG31)* genes most often implicated. AR forms are seen much less often, and include HSP type 7

due to mutated *SPG7*, and clinically there may be optic disc pallor and an axonal neuropathy.

XL forms also exist and these are complicated forms of HSP that include the *LICAM (SPG1)* gene, also implicated in **X-linked hydrocephalus**, and the *PLP1 (SPG2)* gene, associated with a broader phenotype known as **Pelizaeus-Merzbacher disease**, with characteristic white matter changes on MRI and peripheral neuropathy.

### Spinal Muscular Atrophy (SMA)

There are a variety of rare disorders classified under ‘SMA’ but the best known and most common concerns molecular pathology at the *SMN1* gene locus. This is recessively inherited and characterized by degeneration of the anterior horn cells of the spinal cord leading to progressive muscle weakness and ultimately death. Three common childhood forms, and one adult-onset form (Box 19.1), are recognized with an incidence, collectively, of approximately 1:10,000. The carrier frequency is therefore close to 1:50. In fact, although three childhood types are described, it is clear that they constitute a continuum.

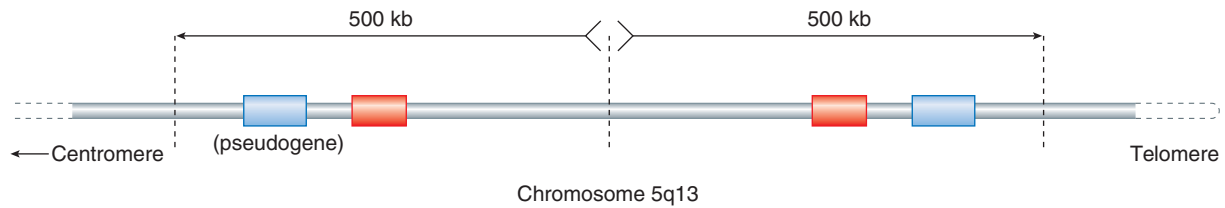
#### Clinical Features

**SMA type I**, also known as **Werdnig-Hoffmann disease**, presents before 6 months, often within days of birth, with significant hypotonia and poverty of movement. Fetal movements may have been reduced. Affected children show normal development otherwise but profound muscle weakness leads to death within the first 2 years of life, often before 12 months. Electromyography has been superseded by genetic testing to make the diagnosis and there is currently no effective treatment.

**SMA type II** is less severe than type I with onset between 6 and 12 months, though the main presenting features are also muscle weakness and hypotonia. Affected children sit unaided but never achieve independent locomotion, and the rate of progression is slow with survival into early adulthood.

#### Box 19.1 Definition of the Different Forms of Spinal Muscular Atrophy (SMA)

- SMA I: onset before 6 months of age
- SMA II: onset between 6 and 12 months of age
- SMA III: onset after 12 months of age and able to walk  $\geq 25$  meters (current or historical)
- SMA IV: adult onset



**FIGURE 19.5** The inverted duplication with the *SMN* and *NAIP* genes. SMA occurs when both copies of the *SMN1* gene are mutated (AR inheritance); in 95% to 98% this is a deletion of exons 7–8, and point mutations in the remainder. *SMN*, Survival motor neuron; *NAIP*, neuronal apoptosis-inhibitory protein.

**SMA type III**, also known as **Kugelberg-Welander disease**, presents after 12 months and limited walking is achieved. Slow progression leads to the use of a wheelchair by early adult life and long-term survival can be compromised by recurrent respiratory infection and the development of a scoliosis.

### Genetics

SMA follows AR inheritance, with the exception of some rarer forms, where dominant and XL inheritance may apply (e.g., spinal and bulbar muscular atrophy, *aka* Kennedy disease, see [Figure 2.5](#)). SMA type I as described due to *SMN1* generally shows a high degree of intrafamilial concordance, with affected siblings showing an almost identical clinical course, though in types II and III more intrafamilial variation occurs.

*SMN1* is located on chromosome 5q in a region which is noted for its instability, and at this locus an inverted, duplicated segment occurs ([Figure 19.5](#)). There are also a relatively large number of pseudogenes ([p. 12](#)). The *SMN* genes are now referred to as *SMN1* and *SMN2* (the pseudogene of *SMN1* that shares approximately 99% homology). *SMN1* shows homozygous deletion of exons 7–8 in 95% to 98% of all patients with childhood-onset SMA. Point mutations in *SMN1* have been identified in 1% to 2% of patients with childhood SMA who do not show the exons 7–8 deletion on one allele. The number of copies of *SMN2*, arranged in tandem in *cis* configuration on each chromosome, varies between zero and five. It produces a similar transcript to *SMN1* but this is not sufficient to fully compensate. Nevertheless, the presence of copies of *SMN2* modifies the phenotype and there is a broad correlation between the number of copies of *SMN2* and the degree of mildness.

*SMN1* is always mutated in SMA, in the vast majority by deletion of exons 7–8, and in the remainder by point mutation. Diagnostic testing is therefore very reliable and prenatal testing is an option for those couples who request it, assuming both parents are carriers. Carrier detection is based on determining the number of exon 7–containing *SMN1* gene copies present in an individual. However, results can be difficult to interpret because some carriers have the normal number of *SMN1* gene copies caused by the presence either of two *SMN1* gene copies in *cis* configuration on one chromosome, or of a *SMN1* point mutation. Approximately 4% of the general population has two copies of *SMN1* on a single chromosome. Furthermore, 2% of individuals with SMA have one *de novo* mutation, meaning that only one parent is a carrier. Because of these difficulties, SMA carrier testing should be provided in the context of formal, expert genetic counseling.

### Motor Neurone Disease (MND)

Each year up to 3 per 100,000 of the population are diagnosed with this condition, which is the same as **amyotrophic lateral**

**sclerosis (ALS)**, and also known as **Lou Gehrig disease**. It follows on neatly from SMA because adult-onset SMA is part of the differential diagnosis of ALS, and is a progressive neurodegenerative condition of both upper and lower motor neurons. The presentation may be with focal and asymmetric weakness in the extremities or with bulbar signs such as dysphagia or dysarthria. The basic diagnostic criteria are shown in [Box 19.2](#). The average age of onset is approximately 56 years and most patients live only 1–5 years from diagnosis to death as they become increasingly weak and respiratory function declines. Some aspects of cognitive function are affected in approximately a third of sufferers.

Roughly 10% of ALS is familial—FALS—and in this group the average age of onset is approximately 46 years. As with so many other inherited neurological disorders, FALS is proving to be genetically heterogeneous with rapid recent progress through the power of next generation sequencing. Most follow AD inheritance but some rare recessive forms have been reported. For many years we knew of only one gene for FALS, namely *SOD1*, but this accounts for only approximately 20% of familial ALS. Some *SOD1* variants are associated with ‘mild’ ALS and a slowly progressive course up to 20 years. A slightly larger proportion of cases are now known to be due to mutated *C9orf72*, which is also implicated in familial fronto-temporal dementia. The mutation is a heterozygous expansion of a non-coding GGGGCC hexanucleotide repeat, which leads to the loss of one alternatively spliced transcript of *C9orf72*. Approximately 4% of FALS is associated with a mutation in the *FUS* gene, and a similar proportion to the *TARDBP* gene.

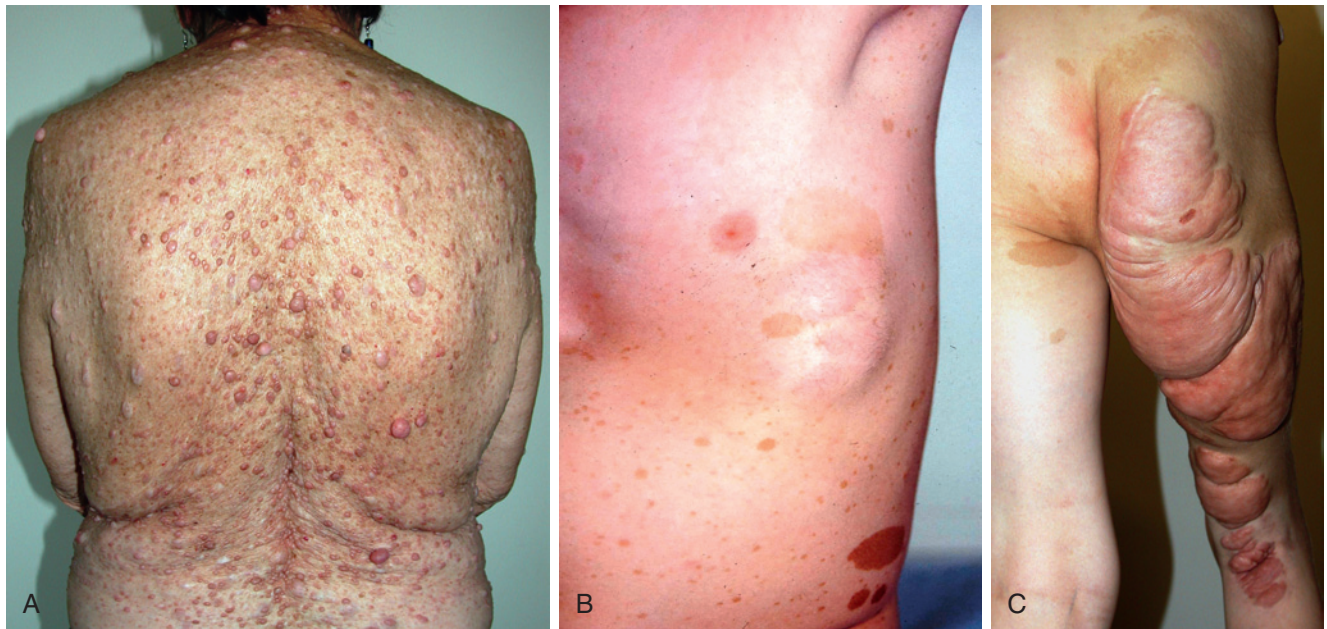
### Neurocutaneous Disorders

This group of neurological disorders is diverse but the common clinical feature is the presence of disease manifestations of the

#### Box 19.2 Diagnostic Criteria for Amyotrophic Lateral Sclerosis (Motor Neurone Disease)

- Evidence of (all three):
  1. Lower motor neuron degeneration—clinically, electrophysiologically, or by neuropathology assessment
  2. Upper motor neuron degeneration—clinically
  3. Progressive spread of symptoms or signs—within a region or to other regions
- Absence of evidence of:
  1. Other disease or processes to explain the neurological signs—electrophysiologically or by pathology
  2. Other disease processes—by neuroimaging





**FIGURE 19.6** Neurofibromatosis type 1. **A**, A patient with neurofibromatosis type I showing truncal freckling and multiple neurofibromata. **B**, Café-au-lait spots on the chest of a child, axillary freckling, and a subcutaneous plexiform neurofibroma below and lateral to the left nipple. **C**, A large and unsightly plexiform neurofibroma affecting the left buttock and leg.

skin, which in some conditions is crucial to the diagnosis. We cover only the better known ones here.

### Neurofibromatosis Type 1 (NF1)

NF1 and NF2 have some overlapping features but in truth are distinct conditions and hence dealt with separately here. NF1 has a birth incidence of approximately 1:3000 and references to the clinical features first appeared in the eighteenth-century medical literature. Historically, however, the disorder is associated with Von Recklinghausen, a German pathologist who coined the term ‘neurofibroma’ in 1882. It is one of the most common genetic disorders in humans and gained a public profile when it was suggested that Joseph Merrick, the ‘Elephant Man’, might have been affected. However, it is now thought he had **Proteus syndrome**.

### Clinical Features

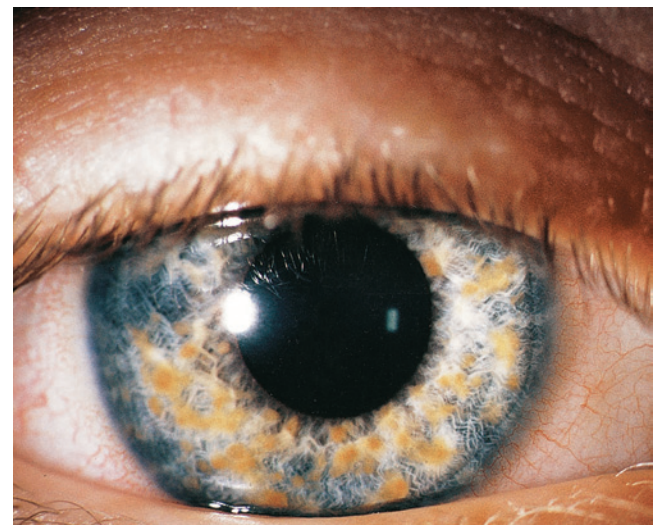
The most notable features of NF1 are small pigmented skin lesions, known as **café-au-lait** (CAL) spots, and small soft fleshy growths known as **neurofibromata** (Figure 19.6A). CAL spots first appear in early childhood (Figure 19.6B) and continue to increase in both size and number until puberty. A minimum of six CAL spots at least 5 mm in diameter is required to support the diagnosis in childhood, and an additional feature such as axillary and/or inguinal freckling should be present. Neurofibromata are benign tumors that arise most commonly in the skin, usually appearing in adolescence or adult life, and increasing in number with age. However, large **plexiform** neurofibromata (Figure 19.6C) may occur and be deep seated and/or cutaneous. As well as being cosmetically unsightly they can interfere with function, depending on their location.

Other clinical findings include relative macrocephaly and Lisch nodules. The latter are small harmless raised pigmented hamartomata of the iris (Figure 19.7). The most common complication, occurring in a third of childhood cases, is mild developmental delay characterized by a non-verbal learning

disorder. For many, significant improvement is seen through the school years. Most individuals with NF1 enjoy a normal life and are not unduly inconvenienced by their condition. However, a small number of patients develop one or more major complications, such as epilepsy, a central nervous system tumor, or scoliosis.

### Genetics

NF1 shows AD inheritance with virtually 100% penetrance by age 5 years. Variability and striking differences in disease severity can be seen within affected families, though monozygotic twins are usually very similar. Approximately 50% of cases are due to new mutations, with the estimated mutation rate being



**FIGURE 19.7** Lisch nodules seen in neurofibromatosis type 1. (Courtesy Mr. R. Doran, Department of Ophthalmology, General Infirmary, Leeds, UK.)

approximately 1 per 10,000 gametes. This is approximately 100 times greater than the average mutation rate per generation per locus in humans.

Where more than one affected child is born to unaffected parents this is almost always the result of gonadal mosaicism (p. 76), usually paternal in origin. Somatic mosaicism in NF1 can manifest with features limited to a particular part of the body. This is referred to as **segmental NF**.

The NF1 gene, *neurofibromin-1*, mapped in 1987 following the identification of two patients with balanced translocations involving a breakpoint at 17q11.2, is large, spanning greater than 350kb of genomic DNA and comprising 61 exons. Three distinct genes lie *within* a single intron of *neurofibromin-1*, where they are transcribed in the opposite direction (p. 10). The neurofibromin protein encoded by this gene shows structural homology to the guanosine triphosphatase (GTPase)-activating protein (GAP), which is important in signal transduction by downregulating RAS activity. The place of neurofibromin in the RAS-MAPK pathway is shown in Figure 16.12, highlighting the link with Noonan syndrome (p. 220). Loss of heterozygosity (p. 183) for chromosome 17 markers has been observed in several malignant tumors in patients with NF1, as well as in a small number of benign neurofibromata, indicating that the gene is a tumor suppressor (p. 182), and it contains a GAP-related domain (GRD), which interacts with the RAS proto-oncogene product. An mRNA editing site exists in the *neurofibromin-1* gene and edited transcript causes GRD protein truncation, which inactivates the tumor suppressor function. A higher range of editing is seen in more malignant tumors.

Other genes, including *TP53* (p. 183) on the short arm of chromosome 17, are also involved in tumor development and progression in NF1. Conversely, it is also known that the *neurofibromin-1* gene is implicated in the development of sporadic tumors not associated with NF, including carcinoma of the colon, neuroblastoma, and malignant melanoma, confirming that it plays an important role in cell growth and differentiation.

Many different mutations have been identified in *neurofibromin-1*, including deletions, insertions, duplications, and point substitutions (p. 17). Most lead to severe truncation of the protein or complete absence of gene expression. There is little evidence for a genotype-phenotype relationship with the exception of one specific mutation, a 3-bp in-frame deletion in exon 17, which has recurred in different cases and families, and affected individuals do not appear to develop cutaneous neurofibromata. Generally, NF1 shows quite striking intrafamilial variation, suggesting the possibility of modifier genes. Patients with large deletions encompassing the entire *neurofibromin-1* gene tend to be more severely affected, with significant intellectual impairment, a somewhat marfanoid habitus, and a larger than average number of cutaneous neurofibromata.

### Legius Syndrome

This fairly rare condition is the closest known 'phenocopy' to NF1; indeed, it may be very difficult to distinguish from NF1 clinically. The features are multiple CAL macules but patients lack neurofibromas and other tumors such as optic nerve glioma, as well as Lisch nodules and sphenoid wing dysplasia. They may have mild macrocephaly, intertriginous freckling, lipomas, and mild learning disabilities or ADHD, all of which is easily mistaken for NF1. It is associated with mutations in

the *SPRED1* gene, which is also part of the RAS-MAPK signal transduction pathway (see Figure 16.12) and a negative regulator.

### Neurofibromatosis Type 2 (NF2)

NF2 is rare compared with NF1 with a birth incidence of approximately 1:35,000 and prevalence of approximately 1:60,000. Both CAL spots and neurofibromata can occur, but much less commonly than in NF1. The cardinal feature is the development in early adult life of tumors involving the eighth cranial nerves—**vestibular schwannomas** (still sometimes called **acoustic neuromas**), which are best treated early if possible by stereotactic radiotherapy. Several other central nervous system tumors occur frequently, e.g., meningioma, although more than half remain asymptomatic. An ophthalmic feature seen in NF2, but not NF1, is cataracts, which are frequent but often subclinical. AD spinal and peripheral schwannomas without vestibular schwannomas is an entity known as **schwannomatosis**.

The NF2, or *neurofibromin-2*, gene on chromosome 22q was identified in 1993 and is thought to be a cytoskeleton protein that acts as a tumor suppressor. Deletions and point mutations in the gene give rise to the condition, though in contrast to NF1 deletion cases tend to be mild, rather than severe, compared with point mutations. The frequency of somatic mosaicism in NF2 is significant and generally associated with a low offspring risk.

NF2 is one condition where therapeutic options have become a reality recently. Administration of the angiogenesis inhibitor, bevacizumab, has been demonstrated to reduce the size of spinal tumors. It is a recombinant monoclonal antibody that exerts its negative effects on angiogenesis by inhibiting vascular endothelial growth factor A, a chemical that aberrantly promotes angiogenesis.

### Tuberous Sclerosis (TSC)

The incidence of this well-known multisystem, dominantly inherited, and very variable neurocutaneous disorder is approximately 1:6000. It has already been used (Figure 6.5) to illustrate patterns of inheritance because a high proportion of cases (~75%) occur de novo but it may also demonstrate variable penetrance to the extent that it appears to 'skip' a generation sometimes. Furthermore, clinical geneticists have to be very aware of the risk of gonadal mosaicism (p. 76). Whilst this is usually quoted as approximately 1% to 2% we have personally seen this affect three couples in southwest England, more than expected.

### Clinical Features

The facial rash of TSC, angiofibromas, or 'adenoma sebaceum' (Figure 19.8; Figure 6.5A), can vary from being florid to virtually non-existent and is one of several classic skin features. The others are hypomelanotic macules (Figure 19.9), shagreen patches, and ungual fibromas (Figure 6.5B), which appear after 10 years of age. Examination of the eye may reveal multiple retinal nodular hamartomas or achromic patches and, internally, the organs typically affected are the brain, kidney, heart and lung (Box 19.3). Almost 100% of patients have a cutaneous manifestation of TSC, a renal abnormality on ultrasound scan is present in approximately 80% by age 10 years, CNS pathology in approximately 90%, seizures in approximately 80%, and learning disability in greater than 50%. Cardiac rhabdomyomas



**FIGURE 19.8** Tuberous sclerosis—facial angiofibromas, or ‘adenoma sebaceum’.

occur in up to two-thirds of cases, are particularly evident early in life and when seen on fetal ultrasound are an important marker for TSC, and they usually regress by adulthood.

Management and treatment options for TSC now include the group of drugs known as mTOR inhibitors, including rapamycin and everolimus, and [Figure 19.10](#) shows the signaling pathway, their site of action, and the conditions linked to components of the pathway.

### Genetics

Heterozygous mutations in two different genes, *TSC1* (~30%) and *TSC2* (~70%), cause TSC and mutations are found in approximately 90% of patients meeting the clinical criteria for a diagnosis. The *TSC2* gene lies adjacent to the *PKD1* gene (for AD polycystic kidney disease, see below), so that a contiguous gene deletion affecting both occasionally occurs. Generally speaking, pathogenic variants in *TSC2* tend to give rise to a more severe phenotype than pathogenic variants in *TSC1*, e.g., in terms of the risk for renal malignancy, learning disability and behavior disorders.

### Muscular Dystrophies

As there are at least 100 muscular dystrophies we can cover only those most likely to be encountered in clinical practice, and collectively they have a hugely important place in human



**FIGURE 19.9** Tuberous sclerosis—depigmented ‘ash leaf’ patches on the trunk.

### Box 19.3 The Clinical Features of Tuberous Sclerosis

#### Skin

- Facial angiofibromas
- Hypopigmented macules
- Shagreen patches
- Ungual fibromas

#### Eye

- Retinal nodular hamartomas
- Achromic patches

#### Brain

- Subependymal nodules
- Cortical dysplasias, including ‘tubers’
- Subependymal giant cell astrocytomas (SEGAs)

#### Kidney

- Benign angiomyolipomas (common)
- Renal cysts
- Malignant angiomyolipomas and renal cell carcinoma (rare)

#### Heart

- Rhabdomyomas

#### Lung

- Lymphangiioleiomyomatosis
- Multifocal micronodular pneumonocyte hyperplasia

#### CNS-related manifestations

- Seizures
- Autistic spectrum disorder/ADHD
- Learning disability
- Disruptive behavior

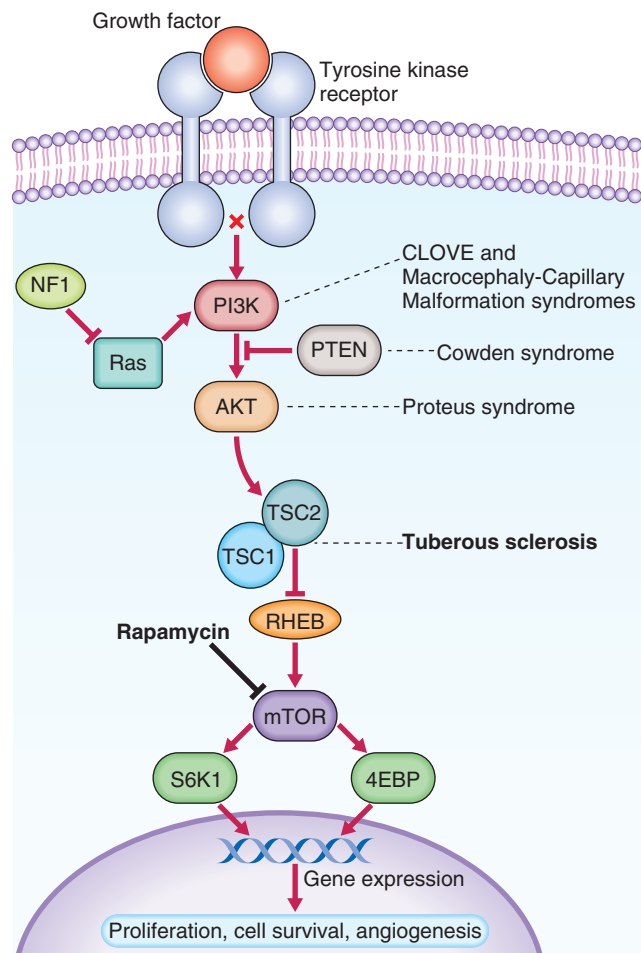
and medical genetics, the history of which has been superbly documented by Professor Alan Emery. [Figure 19.11](#) shows the principle muscle groups affected in the more common dystrophies, four of which are covered in the text.

### Duchenne and Becker Muscular Dystrophies (DMD and BMD)—Xp21

DMD and BMD together are sometimes referred to as Xp21-dystrophies on account of the genetic basis being mutations in the *dystrophin* gene, *DYS*, at this locus. DMD is the most common severe form of muscular dystrophy and BMD its much milder ‘companion’. The French neurologist Guillaume Duchenne described a case in 1861 but Edward Meryon, an English physician had documented it a decade earlier, as championed by Alan and Marcia Emery. The incidences of DMD and BMD are approximately 1 : 3500 males and 1 : 20,000 males, respectively.

#### Clinical Features

Males with DMD usually present between the ages of 2 and 4 years with slowly progressive muscle weakness resulting in an awkward gait, inability to run quickly, and difficulty in rising from the floor, which can be achieved only by pushing on, or ‘climbing up’, the legs and thighs (Gowers’ sign). Most affected boys require a wheelchair by the age of 11 because of severe proximal weakness. Subsequent deterioration leads to lumbar lordosis, joint contractures, and cardiorespiratory failure, resulting in death at approximately 20 years without supportive measures, though life expectancy has been improving as a result of some treatment options and careful management, such as steroids and respiratory support in the form of continuous positive airways pressure (CPAP).



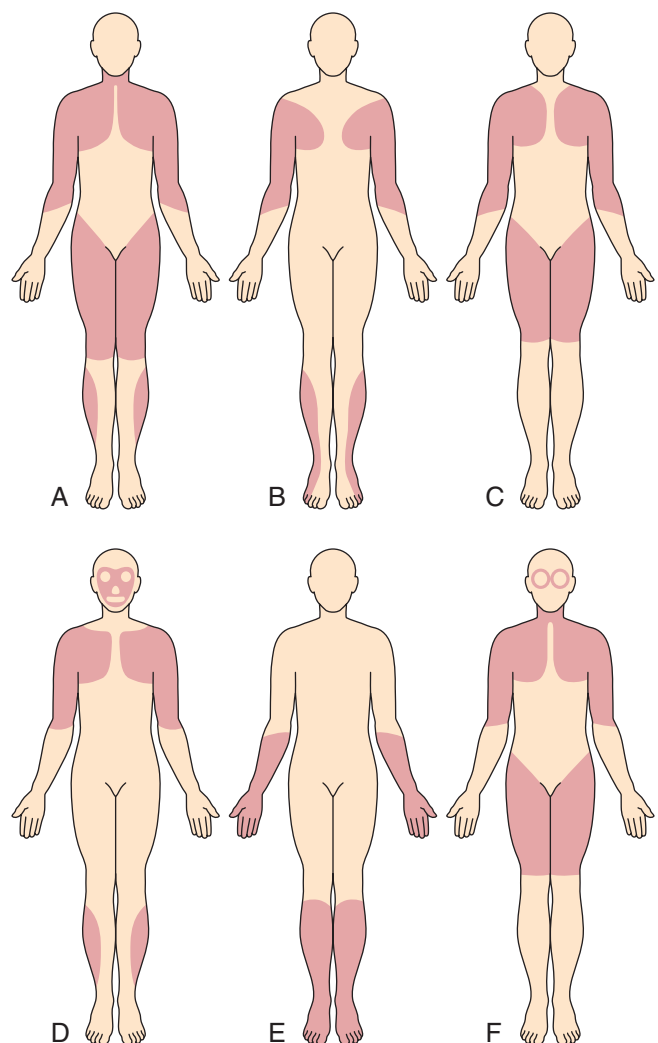
**FIGURE 19.10** The mTOR signaling pathway. Also known as the PI3K/AKT/mTOR pathway, it is an important intracellular pathway in regulating the cell cycle. Activation of the pathway by growth factors controls protein synthesis at the level of translation initiation and ribosome biogenesis, ultimately leading to cell growth, proliferation, and survival. Alterations in control of the pathway, e.g., through mutations of the genes encoding these proteins, can result in cellular transformation. The agent rapamycin inhibits mTOR activity and therefore blocks AKT-induced tumorigenesis. Altered proteins in the pathway (and the genes encoding them) are linked to genetic conditions as indicated, with particular attention drawn here to tuberous sclerosis.

Males with either DMD or BMD, show an apparent increase in the size of the calf muscles, but this is due to replacement of muscle fibers by fat and connective tissue—referred to as **pseudohypertrophy** (Figure 6.14; Figure 19.12). In addition, approximately one-third of boys with DMD show mild-moderate intellectual impairment, with the mean IQ approximately 83. BMD is similar but runs a much less aggressive course. The mean age of onset is 11 years and many patients remain ambulant until well into adult life with life expectancy only slightly reduced. A few patients with proven mutations in the DMD/BMD gene have been asymptomatic in their fifth or sixth decade.

### Genetics

These are classic XL recessive diseases and as males with DMD rarely, if ever, reproduce, the genetic fitness is zero. The mutation rate equals the incidence of affected males divided by

three (p. 86), which approximates to 1:10,000—one of the highest known mutation rates in humans. Identification of the *dystrophin* gene in 1987 represented a major scientific achievement at the time, because of a successfully applied positional cloning strategy. Clues to the DMD locus were provided by reports of females affected with DMD who had balanced X-autosome translocations—the breakpoint in common being at Xp21. In such cases, those cells in which the derivative X chromosome is randomly inactivated are greatly disadvantaged because of inactivation of the autosomal segment (Figure 6.16; p. 73), which would most likely be developmentally catastrophic. Consequently, cells in which the normal X chromosome has been randomly inactivated are more likely to survive. The net result is that the derivative X-autosome is active in most cell lines, and if the breakpoint has damaged an important gene, in this case *dystrophin*, the individual will be affected by the disease which otherwise is almost always seen in males. Additional clues emerged from affected males with small cytogenetically visible deletions incorporating Xp21, followed



**FIGURE 19.11** The muscle groups principally affected (shaded areas) in the more commonly encountered muscular dystrophies. **A**, Duchenne and Becker types; **B**, Emery-Dreifuss; **C**, limb-girdle; **D**, facioscapulohumeral; **E**, distal; **F**, oculopharyngeal. **E** and **F** are not covered in the text. (Reproduced from Emery A 1988 *The muscular dystrophies*. *BMJ* 317:991–995 by permission of the BMJ Publishing Group.)



**FIGURE 19.12** Lower limbs of an adult male with Becker muscular dystrophy showing proximal wasting and calf pseudohypertrophy.

by the identification of conserved sequences in muscle cDNA libraries that were shown to be exons from the gene itself.

The *dystrophin* gene is huge in molecular terms, which may explain the high mutation rate, consisting of 79 exons and spanning 2.3 Mb of genomic DNA, of which only 14 kb are transcribed into mRNA. It is transcribed in brain as well as muscle, which explains why some boys with DMD show learning difficulties. Deletions of various sizes, and almost any location, account for two-thirds of all *dystrophin* gene mutations and arise almost exclusively in *maternal* meiosis, probably due to unequal crossing over. Some affected males have **duplications**. Deletion 'hotspots' occur in the first 20 exons and exons 45 through 53. One of the deletion breakpoint hotspots in intron 7 contains a cluster of transposon-like repetitive DNA sequences that could facilitate misalignment in meiosis, with a subsequent crossover leading to deletion and duplication products.

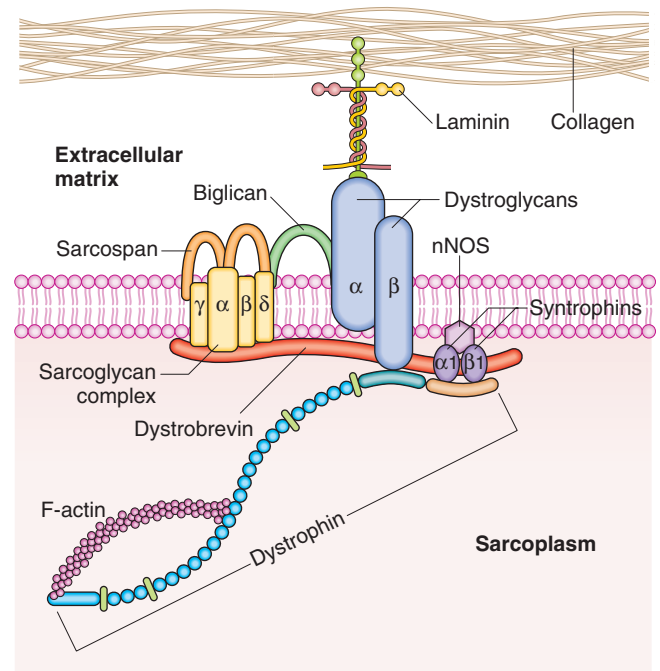
Deletions causing DMD usually disturb the translational reading frame (p. 15) whilst those seen in males with BMD usually do not alter the reading frame (i.e., they are 'in-frame'). This means that the amino-acid sequence of the protein product downstream of the deletion is normal, explaining the relatively mild features in BMD. Indeed, we personally know of one family with an in-frame deletion of exons 49–51 where males are entirely asymptomatic. Mutations in the other third of boys with DMD include stop codons, frameshift mutations, altered splicing signals and promoter mutations, most leading to premature translational termination and little, if any, protein

product. In contrast to deletions, point mutations in the *dystrophin* gene often arise in *paternal* meiosis, most probably because of a copy error in DNA replication. Full sequencing of the *dystrophin* gene has transformed molecular diagnosis of DMD and carrier detection.

The 427-kDa *dystrophin* protein is located close to the muscle membrane, where it links intracellular actin with extracellular laminin. Absence of dystrophin, as in DMD, leads gradually to muscle cell degeneration. The presence of dystrophin in a muscle biopsy sample can be assessed by immunofluorescence and levels less than 3% are diagnostic. In muscle biopsies from males with BMD, the dystrophin shows qualitative rather than gross quantitative abnormalities.

Dystrophin binds to a glycoprotein complex in the muscle membrane through its C-terminal domain (Figure 19.13). This glycoprotein complex consists of several subunits, abnormalities of which cause other rare genetic muscle disorders, including several different types of AR limb girdle muscular dystrophy, as well as congenital muscular dystrophy.

Before DNA analysis, determination of carrier status was based on pedigree information combined with serum creatine kinase (CK) assay. CK levels are grossly increased in boys with DMD, and marginally raised in approximately two-thirds of all carriers (see Figure 11.2; p. 145). CK levels are only



**FIGURE 19.13** The dystrophin-associated protein complex (DAPC). Dystrophin lies beneath the basal lamina and extends through the sarcoplasm, binding cytoskeletal F-actin through its N-terminus domain and the DAPC through its C-terminus. It therefore links the internal cytoskeleton and extracellular matrix. The central rod domain (blue circles) is formed by triple-helical segments, interrupted by four hinge regions. The C-terminal region binds  $\beta$ -dystroglycan as well as the syntrophins and  $\alpha$ -dystrobrevin. In addition, dystrobrevin links dystrophin with the sarcoglycan-sarcospan complex which is also indirectly linked to dystrophin through the dystroglycan complex ( $\alpha$ -dystroglycan and  $\beta$ -dystroglycan). The individual sarcoglycan subunits are each implicated in different forms of limb-girdle muscular dystrophy. (Redrawn from Fairclough et al and Rahimov et al 2014 *Biology* 3(4): 752–780.)

occasionally useful today as *dystrophin* can be fully sequenced, and linkage studies are sometimes undertaken where no DNA is available from a deceased affected male but DNA from normal males in the family can help to build an informative picture—each situation has to be individually assessed. The interpretation of linkage data must take account of the high recombination rate of 12% across the DMD gene.

At present, there is no cure for DMD or BMD, though aggressive support through physiotherapy, the use of steroids and CPAP is improving life expectancy by a few years. Gene therapy approaches may offer hope in the long term. Using transgenic and naturally occurring *dystrophin*-negative mutant mice, direct injection of recombinant DNA, myoblast implantation, and transfection with retroviral or adenoviral vectors carrying a *dystrophin* minigene (containing only those sequences that code for important functional domains) have all been tried. Another approach is antisense technology to block an exon splicing enhancer sequence—‘exon-skipping’—in order to generate a protein with an in-frame deletion that encodes a protein with residual function, i.e., a BMD rather than a DMD phenotype. The latest technique offering hope—‘gene editing’—using a molecular approach called CRISPR (p. 210), has similar aims and relies on a sequence of RNA to steer the enzyme Cas9 to the mutation site in *dystrophin*. Cas9 excises the faulty exon and repairs the DNA sequence to produce a shortened, functional version of the gene. This has been shown to improve performance in mice, which were injected in multiple muscle sites with a viral vector.

### Limb-Girdle Muscular Dystrophies (LGMD)

This broad group of muscular dystrophies are rarer than their dystrophinopathy counterparts but a number of them are biologically related by virtue of the common mechanistic link and interaction of membrane-bound muscle proteins (see Figure 19.13)—the sarcoglycan complex. Clinically, the pattern of weakness and wasting is mostly confined to the limbs with proximal groups more severely affected than distal. The age of onset, progression, and natural history vary greatly according to the genetic subtype. Serum CK is usually elevated but not to enormous levels in males with DMD, and a muscle biopsy shows degeneration and regeneration (dystrophic) changes. Once an XL dystrophinopathy has been ruled out, specific immunostaining or immunoblotting can be performed on muscle tissue to help reach a more precise diagnosis, i.e., whether a sarcoglycanopathy, calpainopathy, dysferlinopathy, or even dystroglycanopathy (O-linked glycosylation defects). Where staining points to a particular protein abnormality, mutation studies of the corresponding gene can be performed.

Regarding subtypes, LGMD type 1 is the designation reserved for those entities following AD inheritance, whilst LGMD2 covers the AR forms. The latter incorporates the sarcoglycanopathies as well as calpain and dysferlin, and cardiac involvement is sometimes present. The dystroglycanopathies cover most of the congenital muscular dystrophies, e.g., the *FKRP*, *FKTN*, *POMT1*, and *POMT2* genes. LGMD1 incorporates defects of caveolin (LGMD1C; *CAV3* gene)—the so-called ‘rippling muscle disease’—and desmin (LGMD1D; *DES* gene), which can also include cardiac conduction problems and a form of dilated cardiomyopathy. LGMD1B defines the condition due to mutations in *LMNA*, in which cardiac conduction defects are also important. The *LMNA* gene is known for the extreme diversity of the phenotypes with which it is associated (p. 66), but in this context it is synonymous with the

autosomal variety of Emery-Dreifuss muscular dystrophy (EDMD), and both dominant and, rarely, recessive forms occur.

The XL recessive EDMD is worthy of mention here, not only because it is an important differential diagnosis of the LGMD group but also because of the pioneering work of the geneticist after whom both the condition, and this book, is named. Muscle weakness and wasting is progressive and seen firstly in a humero-peroneal distribution, later extending to the scapular and pelvic girdle muscles. This is accompanied by the onset of contractures of the elbow joints and Achilles tendons in childhood, and cardiac involvement including arrhythmia and later congestive heart failure. The *EMD* gene encodes the protein emerin, which localizes to the inner nuclear membrane and functions in anchorage of the membrane to the cytoskeleton.

### Facioscapulohumeral Muscular Dystrophy (FSHD)

FSHD occurs in up to 10 per 100,000 of the population, follows AD inheritance, and is characterized, as the name helpfully indicates, by muscle weakness involving the face, scapular muscles, and upper arm. In addition, the peroneal and hip girdle muscles of the leg are also involved. It is very variable but usually presents in adolescence and is progressive, approximately 20% of sufferers requiring a wheelchair by mid-life. Winging of the scapulae is evident (Figure 19.14) and facial weakness can be assessed by asking the patient to attempt to smile (Figure 19.15), whistle, pout the lips, and grimace, all of which are limited. Eyelid weakness is present and some sufferers are noted to sleep with their eyes open. Approximately half of patients have a peripheral retinal vasculopathy, though this does not affect vision, and at least half develop a high tone sensorineural hearing loss.

The genetics of FSHD is intriguing and two types are now recognized. The chromosome 4q35 subtelomeric region contains a microsatellite repeat called *D4Z4*, within which is located a double homeobox gene, *DUX4*. Both FSHD1 and FSHD2 result from inappropriate expression of *DUX4*. Normal *D4Z4* alleles contain between 11 and 100 repeats, each approximately 3.3kb in size, but in FSHD1 contraction of *D4Z4* occurs such that the repeat number is reduced to between one and 10 units. This contraction leads to relaxation, or opening, of the chromatin structure, including the *DUX4* promoter, which in turn causes *derepression* of *DUX4*. FSHD1 therefore follows AD inheritance as these changes are



FIGURE 19.14 Facioscapulohumeral dystrophy. Winging, or prominence, of the scapulae.



**FIGURE 19.15** Facioscapulohumeral dystrophy. Facial muscle weakness—the patient is attempting to smile broadly.

heterozygous at 4q35 and account for approximately 95% of FSHD overall. However, the genetics is further complicated by: 1) the *D4Z4* contraction is pathogenic only on the background of a particular haplotype, and 2) a repeat sequence almost identical to *D4Z4* is present on 10q26 (and therefore readily detected by standard molecular testing) but the *DUX4*-like gene at this locus does not transcribe to a stable product.

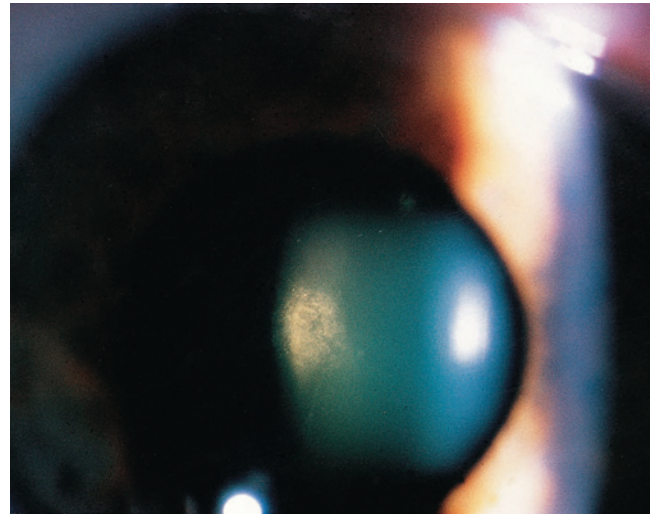
In FSHD2 chromatin relaxation at the *D4Z4* locus also occurs but not due to the contraction of units. Instead, this occurs due to loss of CpG methylation caused by heterozygous mutations in the *SMCHD1* gene (at chromosome 18p11), though again requires the permissive 4q35 haplotype. FSHD2 is therefore an example of digenic inheritance (p. 75)

### Myotonic Dystrophy Type 1 (MD1)

MD1 is the most common form of muscular dystrophy seen in adults, with an overall incidence of approximately 1:8000. Like HD (see Table 19.1), both show AD inheritance with anticipation, and an early-onset form with different clinical features. However, in MD the early-onset form is transmitted almost exclusively by the mother and presents at birth, in contrast to juvenile HD, which is generally paternally transmitted with an age of onset in the teens.

#### Clinical Features

Individuals with MD usually present in adult life with slowly progressive weakness and myotonia. This latter term refers to tonic muscle spasm with prolonged relaxation, which can manifest as a delay in releasing the grip on shaking hands. However, MD1 is a multisystem disorder, and other clinical features include cataracts (Figure 19.16), cardiac conduction defects, disturbed gastrointestinal peristalsis (dysphagia, constipation, diarrhea), weak sphincters, increased risk of diabetes mellitus and gallstones, somnolence, frontal balding, and testicular atrophy. Delayed recovery from general anesthesia may also occur. The age of onset is very variable and in its mildest



**FIGURE 19.16** Refractile lens opacities in an asymptomatic person with myotonic dystrophy. (Courtesy of R. Doran and M. Geall, Department of Ophthalmology, General Infirmary, Leeds, UK.)

form usually runs a relatively benign course. However, as the age of onset becomes earlier, so the clinical symptoms increase in severity and more body systems are involved. In the ‘congenital’ form, affected babies present at birth with hypotonia, talipes, and respiratory distress that can prove life threatening (see Figure 6.19). Children who survive have a facial myopathy with delayed motor development and learning difficulties (Figure 19.17). Important components of the management of MD1 include regular surveillance for cardiac conduction



**FIGURE 19.17** A mother and child with myotonic dystrophy. The child has clear features of facial myopathy and suffers from the congenital form; the mother has only mild facial myopathy. The marked generational difference in the severity of disease illustrates the phenomenon of anticipation.

defects and the provision of information about risks associated with general anesthesia.

Presymptomatic genetic testing and prenatal diagnosis can be offered where appropriate and acceptable, accompanied by a full explanation and support. This is particularly relevant for couples at risk of having a child with the severe congenital form.

### Genetics

It follows AD inheritance with increasing severity in succeeding generations—**anticipation** (p. 75). This was once believed to reflect ascertainment bias but clinical studies in the 1980s confirmed anticipation to be a real phenomenon and the molecular basis provides the explanation. In 1992 the mutational basis was shown to be instability in a CTG repeat sequence, which is present in the 3′ untranslated region of a protein kinase gene, now named dystrophin myotonia protein kinase (*DMPK*). In unaffected persons the CTG sequence lying 3′ to the *DMPK* gene consists of up to 37 repeats (see Table 19.1). Affected individuals have an expansion of at least 50 CTG repeats. There is a close correlation between disease severity and the size of the expansion, which can exceed 2000 repeats or more. The severe congenital cases show the largest repeat copy number, with almost invariable inheritance from the mother. Thus, meiotic or germline instability is greater in the female for alleles containing large sequences. Expansion of a relatively small number of repeats appears to occur more commonly in the male, and most MD mutations are thought to have originated during meiosis in spermatogonia. One possible explanation for these observations is that mature spermatozoa can carry only small expansions, whereas ova can accommodate much larger expansions.

A curious feature of MD1 is the reported tendency for healthy individuals who are heterozygous for MD alleles in the normal size range to preferentially transmit alleles greater than 19 CTG repeats in size. This possible example of meiotic drive (p. 88) might explain the constant replenishment of a reservoir of potential MD mutations.

Perhaps surprisingly, it may be that *DMPK* is not directly responsible for muscle symptoms—mice with both overexpression and underexpression of *Dmpk* show neither myotonia nor other typical clinical features of MD. We now know that the RNA produced by expanded *DMPK* alleles interferes with the cellular processing of RNA produced by a variety of other genes. Expanded *DMPK* transcripts accumulate in the cell nuclei, and are believed to have a gain-of-function effect through binding with a CUG RNA-binding protein (CUG-BP) that has been identified. Excess CUG-BP has been shown to interfere with a number of genes relevant to MD, and CUG repeats are known to exist in various alternately spliced muscle-specific enzymes.

### MD Type 2

Some families with a variable presentation of similar features to MD1, but without the (CTG)<sub>n</sub> expansion of *DMPK*, have a genetically distinct condition linked to 3q21. Originally referred to as **proximal myotonic myopathy**, these cases are designated MD type 2 and the molecular defect has been shown to be a (CCTG)<sub>n</sub> expansion mutation in intron 1 of a gene called *ZNF9*, and its protein is thought to bind RNA. Most families are of German descent, and haplotype studies suggest a single founder mutation occurring between 200 and 500 generations ago.

## Respiratory Disorders

### Cystic Fibrosis (CF)

CF was first recognized as a discrete entity in 1936 and was known as ‘mucoviscidosis’ because of the accumulation of thick mucus secretions that lead to blockage of the airways and secondary infection. Although physiotherapy, antibiotics and pancreatic supplementation have been very effective in increasing the average life expectancy of a child with CF from less than 5 years in 1955 to at least 30 years, CF remains a significant cause of chronic ill health and premature death. CF is the most common severe AR disorder in western Europe, the incidence varying from 1 in 2000 to 1 in 3000. The incidence is slightly lower in eastern and southern European populations, and much lower in African Americans (1 in 15,000) and Asian Americans (1 in 31,000).

### Clinical Features

The organs most commonly affected in CF are the lungs and pancreas. Chronic lung disease caused by recurrent infection eventually leads to fibrotic changes in the lungs with secondary cardiac failure, i.e., **cor pulmonale**. When this occurs the only hope for long-term survival is a successful heart-lung transplant.

In 85% of CF sufferers, pancreatic function is impaired with reduced enzyme secretion from blockage of the pancreatic ducts by inspissated secretions, which leads to malabsorption and an increase in the fat content of the stools. However, it is satisfactorily treated with oral supplements of pancreatic enzymes. Other problems commonly encountered in CF include nasal polyps, rectal prolapse, cirrhosis, and diabetes mellitus. A small percentage of children with CF present in the newborn period with **meconium ileus**—obstruction of the small bowel from thickened meconium.

Almost all males with CF are infertile due to congenital bilateral absence of the vas deferens (CBAVD). On occasion CBAVD is the only feature of CF, and one can debate whether CF is the correct designation. Other rare presentations include chronic pancreatitis, diffuse bronchiectasis, and bronchopulmonary allergic aspergillosis.

### Genetics

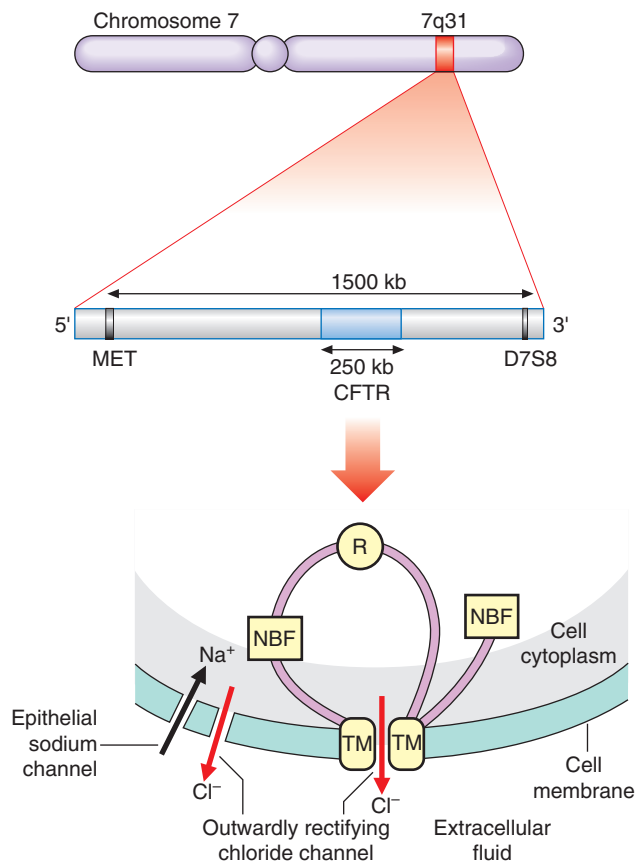
As indicated, CF follows AR inheritance and is relatively common. Possible explanations for the high incidence include a high mutation rate, meiotic drive, and heterozygote advantage. The latter explanation, possibly mediated by increased heterozygote resistance to chloride-secreting bacterially-induced diarrhea, is sometimes favored, though does not explain why CF is rare in tropical regions where diarrheal diseases are common. The mapping and isolation of the CF gene was a celebrated milestone in human molecular genetics and it is easy to forget how very difficult and time consuming such progress was 30 years ago. The CF locus was mapped to chromosome 7q31 in 1985 by the demonstration of a series of linkages to a number of markers. The gene was eventually cloned by two groups of scientists in North America in 1989 by a combination of chromosome jumping, physical mapping, isolation of exon sequences, and mutation analysis. It was named the CF transmembrane conductance regulator (*CFTR*) gene (or alternatively *ABCC7*), spans a genomic region of approximately 250 kb, and contains 27 exons. In due course one particular CF mutation was found to be associated with one particular haplotype pattern in more than 80% of cases, consistent with a single



ancestral mutation having occurred and thus responsible for a large proportion of CF.

The CFTR protein product contains 1480 amino acids with a molecular weight of 168 kDa. It consists of two transmembrane (TM) domains that anchor it to the cell membrane, two nucleotide binding folds (NBFs) that bind ATP, and a regulatory (R) domain, which is phosphorylated by protein kinase-A (Figure 19.18). The primary function of the CFTR protein is to act as a chloride channel. Activation by phosphorylation of the regulatory domain, followed by binding of ATP to the NBF domains, opens the outwardly rectifying chloride channel and exerts a negative effect on intracellular sodium absorption by closure of the epithelial sodium channel. The net effect is to reduce the level of intracellular sodium chloride, which improves the quality of cellular mucus secretions.

The first mutation to be identified in *CFTR* was a deletion of three adjacent base pairs at the 508<sup>th</sup> codon which results in the loss of a phenylalanine residue. Technically, this mutation is c.1521\_1523delCTT or p.Phe508del (though the first designation, 'deltaF508', is still preferred by many), and accounts for approximately 70% of all mutations in *CFTR*, the highest incidence occurring in Denmark at 88% (Table 19.2). More than 2000 other mutations in the *CFTR* gene have been identified. These include missense, frameshift, splice-site, nonsense, and deletion mutations (p. 17). The vast majority are extremely uncommon, although a few can account for a small but



**FIGURE 19.18** The cystic fibrosis locus, gene, and protein product, which influences closely adjacent epithelial sodium and outwardly rectifying chloride channels. *CFTR*, Cystic fibrosis transmembrane conductance regulator; *R*, regulatory domain; *NBF*, nucleotide binding fold; *TM*, transmembrane domain.

**Table 19.2** Contribution of Phe508del Mutation to All CF Mutations

Country	%
Denmark	88
Netherlands	79
UK	78
Ireland	75
France	75
USA	66
Germany	65
Poland	55
Italy	50
Turkey	30

Data from European Working Group on CF Genetics gradient of distribution in Europe of the major CF mutation and of its associated haplotype. Hum Genet 1990; 85:436–441, and worldwide survey of the Phe508del mutation—report from the Cystic Fibrosis Genetic Analysis Consortium. Am J Hum Genet 1990; 47:354–359.

significant proportion of mutations in a particular population. For example, the G542X and G551D mutations account for 12% and 3%, respectively, of all CF mutations in the Ashkenazi Jewish and North American Caucasian populations. Commercial multiplex PCR-based kits detect approximately 90% of all carriers and using these can reduce the carrier risk for a healthy individual from 1 in 25 (population risk) to less than 1 in 200.

Mutations in *CFTR* can influence the function of the protein product by:

1. Causing a complete or partial reduction in its synthesis—e.g., G542X and IVS8-6(5T)
2. Preventing it from reaching the epithelial membrane—e.g., Phe508del
3. Causing it to function incorrectly when it reaches its final location—e.g., G551D and R117H.

The net effect is to reduce the normal functional activity of the CFTR protein and reduced protein activity correlates well with the clinical phenotype. Levels of less than 3% are associated with severe, or 'classic', CF, sometimes referred to as the **PI type** because of associated pancreatic insufficiency. Activity levels between 3% and 8% cause a milder 'atypical' form of CF in which there is respiratory disease but relatively normal pancreatic function. This is referred to as the pancreatic sufficient (**PS**) form. Finally, levels of activity between 8% and 12% cause the mildest CF phenotype, in which virtually the only clinical abnormality is CBAVD in males.

The genotype-phenotype relationship is complex; homozygotes for Phe508del almost always have severe classic CF, as do compound heterozygotes with Phe508del and G551D or G542X. The outcome for other compound heterozygote combinations can be much more difficult to predict.

The complexity of the interaction between *CFTR* alleles is illustrated by the IVS8-6 poly T variant. This contains a polythymidine tract in intron 8 that influences the splicing efficiency of exon 9, resulting in reduced synthesis of normal CFTR protein. Three variants consisting of 5T, 7T, and 9T have been identified. The 9T variant is associated with normal activity but the 5T allele leads to a reduction in the number of transcripts containing exon 9. The 5T variant has a population frequency of approximately 5%, but is more often found in patients with CBAVD (40–50%) or disseminated bronchiectasis (30%). Curiously, it has been shown that the number of

thymidine residues influences the effect of another mutation, R117H. When R117H is in *cis* with 5T (i.e., in the same allele) it causes the PS form of CF when another CF mutation is present on the other allele. However, in compound heterozygotes (e.g., Phe508del/R117H) where R117H is in *cis* with 7T, it can result in a milder but variable phenotype, ranging from CBAVD to PS CF. A mild phenotype is likely to result from the expression of higher levels of full-length R117H protein with some residual activity. The increasing number of *CFTR* mutations, and clinical variability, provokes the question that a label of CF may be inappropriate for patients with milder symptoms.

Prenatal testing as well as preimplantation genetic diagnosis can be offered to couples at risk of having a child with CF (see Chapter 20). Carrier testing of the relatives of those who are carriers, or affected with known mutations, is standard practice in many countries—known as **cascade screening**. Population screening aimed at identifying CF carriers (p. 151), and neonatal screening aimed at identifying CF homozygotes (p. 150), have been widely implemented.

CF is a prime candidate for gene therapy because of the relative accessibility of the crucial target organs—the lungs. Several clinical trials in small groups of volunteer patients with CF, using viral vectors in an attempt to deliver a normal copy of *CFTR*, have been disappointing. However, a different approach using a non-viral lipid-based vector delivered by nebuliser has shown a modest benefit. There is cautious optimism that effective gene therapy for CF will be developed eventually.

### Alpha-1 Antitrypsin Deficiency (AATD)

AATD is an important cause of chronic obstructive pulmonary disease (COPD), emphysema being the most likely manifestation but also chronic bronchitis and bronchiectasis, with the onset of symptoms in early middle life in smokers and slightly later in non-smokers. In addition, liver disease may present at almost any age, including obstructive jaundice in infancy. It is inherited as an AR trait with a frequency of 1:1500 or greater, making disease alleles more common in the population than those of CF. However, as a later onset condition with reduced penetrance it is not perceived as being as serious as CF.

The diagnosis relies on biochemical assay of alpha-1 antitrypsin (AAT) levels and, unlike many genetic conditions, mutation analysis of the gene, *SERPINA1*, is unlikely to supersede well established and reliable clinical chemistry. Levels of AAT are low in carriers and very low in homozygotes. Once these low levels have been determined further characterization—‘phenotyping’—of the abnormal protein—the **protease inhibitor (PI)**—is usually performed. The normal function of this protein is to block the damaging action of the body’s protease enzymes. ‘PI typing’ uses the technique of polyacrylamide gel isoelectric focusing (IEF) electrophoresis, with the different protein variants, or isoforms, designated by letters according to their migration pattern. The normal protein is ‘M’—hence the allele is known as PI\*M and most of the population are therefore PI\*MM. The most pathogenic allele, and slowest moving on IEF, is ‘Z’, followed by ‘S’ which shows reduced penetrance, and between them these alleles account for approximately 95% of AATD. Roughly 1:50 people in the general population are PI\*MZ, and approximately 1:20 are PI\*MS.

The emphysema risk for ZZ individuals is greater than 80%, for SZ up to 50%, and for SS there is little difference to the

background risk. Childhood liver disease in AATD is confined to the ZZ phenotype and may occur in up to 20%, being severe in approximately 2%. Between 15% and 20% of ZZ adults over 50 years develop liver cirrhosis, with lower risks at younger ages. It is recognized however, that these risks are higher where a sibling is relatively severely affected, which applies at all ages. The treatment and management of AATD centers on prevention and monitoring. Avoidance or cessation of smoking is crucial, and very good advice for carriers too, and alcohol intake should be minimal. COPD is managed in the standard way, and in severe cases transplantation surgery (lungs and liver) may be indicated.

### Pulmonary Arterial Hypertension (PAH)

In clinical practice PAH is an important cause of morbidity and the symptoms are non-specific, ranging from none to dyspnea (most commonly), general fatigue, syncope, palpitations and chest pain. The majority of cases are secondary to other causes, such as heart disease (including congenital heart disease, cardiomyopathies, valve disease), advanced lung disease (including CF), pulmonary embolism, and hereditary hemorrhagic telangiectasia (HHT—see below). The diagnosis may be suspected clinically and from various non-invasive investigations, such as electrocardiogram (ECG) or echocardiography (providing evidence of right ventricular hypertrophy or strain), but may require confirmation by the invasive procedure of cardiac catheterization and direct measurement of pulmonary artery pressure.

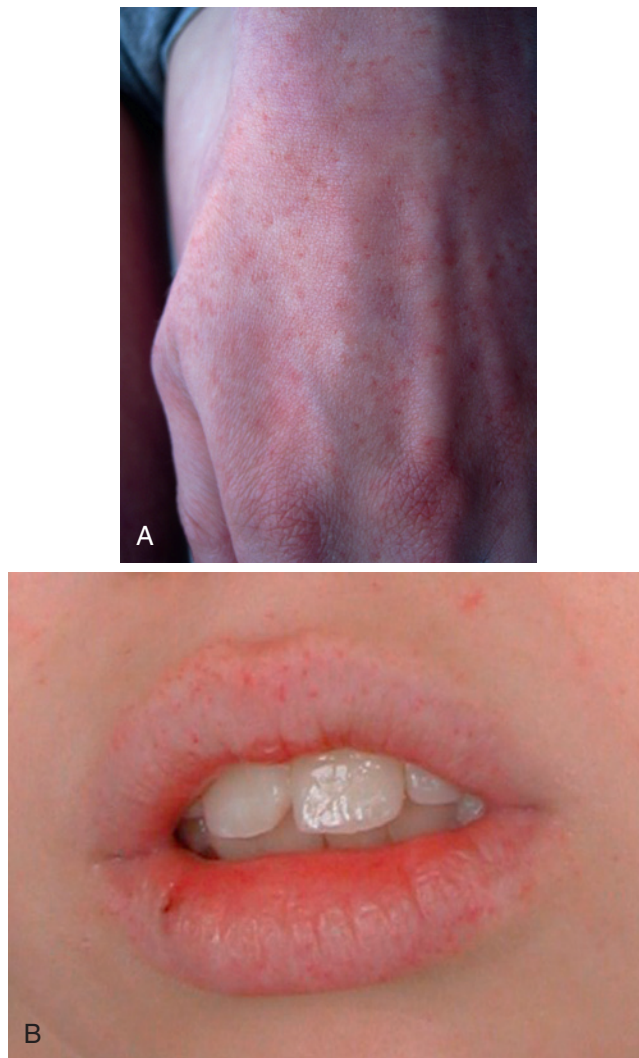
PAH has a place here because of the relatively uncommon heritable form, which is obviously suspected when two or more family members have been affected and other more common causes have been excluded—and used to be known as *primary* pulmonary hypertension. The heritable form follows AD inheritance and is clinically indistinguishable from other causes of PAH. Roughly 75% of cases are caused by a pathogenic variant in the *BMPR2* gene but rarely pathogenic variants in other genes have been identified, including *ACVRL1*, *ENG*, *KCNK3*, *CAV1*, *SMAD9*, and *BMPR1B*. Both *ACVRL1* and *ENG* are important genes in HHT and PAH genes in general are members of the transforming growth factor  $\beta$  (TGF- $\beta$ ) superfamily of cell-signaling molecules (p. 105).

Medical treatment of PAH does not alter the underlying pathology significantly but lung transplantation improves survival—though the limited availability of donors and magnitude of the surgery greatly restrict this option.

### Hereditary Hemorrhagic Telangiectasia

HHT, also known as Osler-Weber-Rendu disease, has almost certainly been underdiagnosed in the past, despite its long historical place in the medical literature. Like hereditary PAH it is essentially a genetically determined disorder of vasculature and the genes implicated are part of the TGF- $\beta$ /BMP signaling cascade (p. 105). The key features are quite distinctive, namely spontaneous and recurrent nosebleeds (epistaxis), multiple mucocutaneous telangiectases seen on the hands (Figure 19.19A), nose, lips, and mouth (Figure 19.19B), and arteriovenous malformations (AVMs) affecting primarily the lungs but also the gastrointestinal tract, liver, and cerebral circulation.

Occasionally, hemorrhage from an AVM can be prolonged and hence serious and life-threatening, simply from extensive blood loss. Hemorrhage from a cerebral AVM, present in approximately 10% of HHT patients, carries a high risk of neurological sequelae, and there is ongoing debate as to whether



**FIGURE 19.19** Hereditary hemorrhagic telangiectasia. Characteristic mucocutaneous telangiectasia on, **A**, the hands, and **B**, the lips.

there is merit in actively scanning patients with HHT to identify such lesions. There is a consensus that pregnant women should have a spinal scan to ascertain whether there are asymptomatic AVMs in the lumbar spinal canal, which would contraindicate having an epidural or spinal anesthetic. There is also a clear consensus to actively screen for pulmonary AVMs by contrast echocardiography, which occur in up to half of affected patients. If large and untreated these can lead to high output heart failure and the migration of emboli to the cerebral circulation can give rise to blood vessel occlusion and cerebral abscess. These are treated by embolization and prophylactic antibiotic cover is recommended for dental procedures.

HHT is an AD condition with several known genes—*ENG*, *ACVRL1* (which together account for the majority of mutation-positive cases), *SMAD4* and *GDF2*. In addition, there are believed to be at least two more loci as yet unknown.

### Inherited Cardiac Conditions (ICCs)

In approximately 4% of sudden cardiac death in persons aged 16 to 64 years, no explanation is evident; this is enormously traumatic for the family left behind. In England this equates

to approximately 200 such deaths annually. Understandably, there can be great anxiety when this is familial and affects young people. The terms **sudden cardiac death (SCD)**, **inherited cardiac condition (ICC)**, and (less often now) **sudden adult death syndrome (SADS)**, are used.

### Inherited Arrhythmias

This group of conditions includes the **long QT syndromes (LQTS)**, **Brugada syndrome**, and catecholaminergic (stress-induced) **polymorphic ventricular tachycardia (CPVT)**. LQTS and Brugada syndrome are sodium and potassium **ion channelopathies**. Calcium channel defects include CPVT, **Timothy syndrome**, and **arrhythmogenic right ventricular cardiomyopathy (ARVC)**, the latter usually considered under 'inherited cardiomyopathies'. Overlap between arrhythmogenic disorders and cardiomyopathies is also evident in the XL (*EMD* gene) and autosomal (*LMNA* gene) forms of **Emery-Dreifuss muscular dystrophy**, the **desminopathies**, and the **caveolinopathies** (mentioned above under 'Limb-Girdle Muscular Dystrophies', p. 284).

When sudden unexplained death occurs, a careful review of the post-mortem findings and an exploration of the history of the deceased, as well as the family history, are indicated. Most who die are young males, and death may occur during sleep or while inactive. In a proportion of cases, death occurs while swimming, especially in LQTS type 1. Emotional stress can be a trigger, especially in LQTS2, and cardiac events are more likely in sleep for LQTS2 and LQTS3. Careful investigation and questioning may reveal an antecedent history of episodes of syncope, palpitation, chest discomfort, and dyspnea, and these symptoms should be explored in the relatives in relation to possible triggers. If the deceased had a 12-lead ECG, this may hold some key evidence; however, a normal ECG is present in approximately 30% of proven LQTS and possibly a higher proportion of Brugada syndrome cases.

In LQTS, also known as **Romano-Ward syndrome**, the ECG findings are dominated by—as the name suggests—a QT interval outside the normal limits, remaining long when the heart rate increases. They are classified according to the gene involved (Table 19.3). The inheritance is overwhelmingly AD but a rare recessive form exists, combined with sensorineural deafness, which is known as **Jervell and Lange-Nielsen syndrome**. The ECG changes may be evident from a young age and a cardiac event occurs by age 10 years in approximately 50%, and by age 20 years in 90%. First cardiac events tend to be later in LQT2 and LQT3. Predictive genetic testing, where possible, is helpful to identify those at risk in affected families, and decisions about prophylactic  $\beta$ -blockade can be made.  $\beta$ -Blockers are particularly useful in LQT1 but less so in LQT2 and LQT3; indeed, it is possible that  $\beta$ -blockers may be harmful in LQT3. Overall, LQTS type 1 and 2 each account for approximately a third of all LQTS, LQTS3 for 5% to 10%, and types 4–15 for less than 1%. Molecular testing is negative in approximately 20%. In perhaps 5% of cases digenic inheritance is seen, usually giving rise to a severe phenotype.

Brugada syndrome, like LQTS, follows AD inheritance and was first described in 1992. The cardiac event is characterized by a proneness to idiopathic ventricular tachycardia (VT), and there may be abnormal ST-wave elevation in the right chest leads with incomplete right bundle branch block. In at-risk family members with a normal ECG, the characteristic abnormalities can usually be unmasked by the administration of potent sodium channel blockers such as flecainide. The

**Table 19.3** The Inherited Cardiac Arrhythmias

Arrhythmia Locus	Onset	Triggers/Other Features	Gene	Locus
LQT1 (Romano-Ward)	90% by age 20 years	Exercise (swimming)	<i>KCNQ1</i>	11p15
LQT2	Early adult life	Stress/sleep	<i>KCNH2</i>	7q35
LQT3	Early adult life	Stress/sleep	<i>SCN5A</i>	3p21
LQT4	Adulthood		<i>Ankyrin-B</i>	4q25
LQT5	Childhood		<i>KCNE1</i>	21q22
LQT6	Adulthood		<i>KCNE2</i>	21q22
LQT7 (Andersen-Tawil syndrome)	Adulthood	Muscle weakness, periodic paralysis, mandibular hypoplasia	<i>KCNJ2</i>	17q23
LQT8 (Timothy syndrome)	Childhood	Syndactyly, learning disability, autism	<i>CACNA1C</i>	12p13
LQT9	Childhood		<i>CAV3</i>	3p25
LQT10	Any age		<i>SCN4B</i>	11q23
LQT11	Childhood		<i>AKAP9</i>	7q21
LQT12	Childhood		<i>SNTA1</i>	20q11
LQT13	Adulthood		<i>KCNJ5</i>	11q24
LQT14	Childhood		<i>CAML1</i>	14q32
LQT15	Childhood		<i>CALM2</i>	2p21
Brugada syndrome	Adulthood		<i>SCN5A</i>	3p21
CPVT	Childhood/adolescence	Stress	<i>RYR2</i>	1q42
ARVC1	Childhood/adolescence		<i>TGFB3</i>	14q23
ARVC2	Childhood/adolescence		<i>RYR2</i>	1q42
ARVC3, 4, 6,	Childhood/adolescence			14q12, 2q32, 10p14
ARVC5	Childhood/adolescence		<i>TMEM43</i>	3p25
ARVC7 (Myofibrillar myopathy)	Childhood/adolescence		<i>DES</i>	2q35
ARVC8	Childhood/adolescence		<i>Desmoplakin</i>	6p24
ARVC9	Childhood/adolescence		<i>PKP2—plakophilin-2</i>	12p11
ARVC10	Childhood/adolescence		<i>DSG2</i>	
ARVC11	Childhood/adolescence		<i>DSC2</i>	
ARVC12 (Naxos disease, autosomal recessive)	Childhood		<i>JUP—plakoglobin</i>	17q21

condition is relatively common in Southeast Asia; there is a male predominance of 8:1, and the average age of arrhythmic events is 40 years but very early onset cases occasionally occur. The definitive treatment is an implantable defibrillator and exercise is not a particular risk factor. Mutations in the *SCN5A* gene are found in approximately 20% of Brugada syndrome patients, as well as some cases of LQT3 (see Table 19.3). In some families both arrhythmias occur. A total of 16 genes are currently implicated in Brugada syndrome, but apart from *SCN5A* all are rare.

In CPVT, also known as **Coumel's VT**, individuals with CPVT present with syncopal events, often in childhood or adolescence, and reproducible stress-induced VT, without a prolonged QT interval. At rest the ECG is normal and the heart is also structurally normal. *RYR2* is the gene most commonly implicated in CPVT—approximately 50% of cases—and heterozygous mutations cause a dominantly inherited form, as with mutations in *CALM1* rarely. Homozygosity, or compound heterozygosity, for mutations in *CASQ2* cause an AR form of CPVT, as with *TRDN* (rare).

### Inherited Cardiomyopathies

**Hypertrophic cardiomyopathy (HCM)** is genetically heterogeneous and the large majority of cases follow AD inheritance. The group includes asymmetric septal hypertrophy, hypertrophic subaortic stenosis, and ventricular hypertrophy. In general, septal hypertrophy of 15mm in isolated cases, and 13mm in

the context of an affected family, is diagnostic of HCM. Sudden death can occur, especially in young athletes. The two most common single genes involved are *MYH7* (14q11) and *MYBPC3* (11p11), which encode the cardiac  $\beta$ -myosin heavy chain and myosin-binding protein C-cardiac type, respectively. The next significant contribution is from *TNNT2* (1q32) and *TNNI3* (19q13), encoding the 'T' and 'I' isoforms of cardiac troponin, but there are many other genes implicated, most of them very rare. The mutation detection rate from gene panel tests is approximately 60% when HCM is clearly familial. Cardiomyopathy associated with *TNNT2*, in particular, may appear to be mild and with subclinical hypertrophy but there is, nevertheless, a high incidence of sudden death. Mutations in this, and some other genes, are sometimes implicated in dilated cardiomyopathy, left ventricular non-compaction, and secondary arrhythmias.

Clinically, when assessing a family, it is important to look for male-male transmission of HCM in the pedigree because this excludes Fabry disease (p. 265) as a cause of cardiomyopathy, and is easily ruled out by a biochemical assay of alpha-galactosidase in males. The astute clinician should also be aware that Noonan syndrome (p. 220) can include HCM as a feature.

**Dilated cardiomyopathy (DCM)** is characterized by cardiac dilatation and reduced systolic function. Causes include myocarditis, coronary artery disease, systemic and metabolic diseases, and toxins. When these are excluded the prevalence of idiopathic DCM is 35 to 40 per 100,000 and familial cases

account for approximately 25%. As with the inherited cardiac arrhythmias, they are genetically heterogeneous but nearly always follow AD inheritance. They are also very variable, and within the same family affected members may show symptoms in childhood at one end of the spectrum, whereas in other individuals the onset of cardiac symptoms may not occur until late in adult life. As with HCM, many genes and loci are implicated in DCM, the most common (up to 20%) being *TTN* (2q31), encoding titin, which may also cause a generalized proximal myopathy. DCM may also result from mutations in the *LMNA* gene (1q22), which encodes lamin A/C and is noted for its pleiotropic effects (p. 66). Overall, because there are several non-genetic causes of DCM, the mutation detection rate from gene panel tests is considerably lower than with HCM.

ARVC, following mainly AD inheritance, is characterized by localized or diffuse atrophy and fatty infiltration of the right ventricular myocardium. It can lead to VT and sudden cardiac death in young people, especially athletes with apparently normal hearts. The ECG shows right precordial T-wave inversion and prolongation of the QRS complex. ARVC demonstrates substantial genetic heterogeneity (see Table 19.3) with eight genes identified, one of which, encoding *plakoglobin*, is implicated in the rare recessive form found on the island of Naxos. As in CPVT, the *RYR2* gene accounts for a proportion of cases (type 2), though *PKP2* is the most common overall, with considerable geographical variation.

Genetic testing is now available within clinical services, but the vast genetic heterogeneity means that the pick-up rate for mutations is low. After a diagnosis has been made in an index

case, a detailed family history is indicated and investigation by ECG and echocardiogram should be offered. Screening may need to continue well into adult life. Among the causes of cardiomyopathy that can be detected relatively easily by a biochemical test is XL Fabry disease, for which enzyme replacement is available (see Table 15.2; p. 205).

## Connective Tissue Disorders

This very broad group of conditions may include, at one end of the spectrum, several hundred skeletal dysplasias. However, we concentrate on the 'mainstream' entities for consistency and include Marfan syndrome and its relations, though for practical clinical purposes these are often grouped with the ICCs.

### Marfan Syndrome (MFS)

The original patient described by the French pediatrician, Antoine-Bernard Marfan, in 1896, probably had the similar but rarer condition now known as **Beal syndrome**, or **congenital contractual arachnodactyly** (p. 293). In clinical practice physicians often consider the diagnosis of MFS for any patient who is tall with subjective features of long limbs and fingers. However, it is essential to be objective in clinical assessment because a number of conditions have 'marfanoid' features, and many tall, thin people are entirely normal. Detailed diagnostic criteria, referred to as the **Ghent criteria**, are in general use by geneticists. In the modern era clinical criteria were published in 1986 (Berlin), brought up to date in 1996 (Ghent; Table 19.4), and the latter underwent revision in 2010 (Table 19.5).

**Table 19.4** Ghent Criteria for Making a Diagnosis of Marfan Syndrome

#### Diagnostic Criteria Interpretation

INDEX CASE (NO CONTRIBUTORY FAMILY HISTORY):

- Major criteria should be present in at least two different organ systems, plus involvement of a third organ system
- If a known pathogenic mutation is present, one major criterion in an organ system plus involvement of a second organ system

RELATIVE OF AN INDEX CASE:

- Presence of a major criterion in the family history, and in the relative one major criterion in an organ system plus involvement of a second organ system

Organ System	Major Criteria	Minor Criteria
Skeletal	Four of these should be present: Pectus carinatum Pectus excavatum requiring surgery Reduced upper to lower segment body ratio or span:height ratio >1.05 Hypermobility of wrist and thumbs Medial displacement of medial malleolus Radiological protrusio acetabulae	Pectus excavatum Joint hypermobility High arched palate with dental crowding Facial features, including down-slanting palpebral fissures causing pes planus
Ocular	Ectopia lentis	Flat cornea Increased axial length of the globe Hypoplastic iris
Cardiovascular	Dilatation of the ascending aorta Dissection of the ascending aorta	Mitral valve prolapse Dilatation or dissection of descending thoracic or abdominal aorta under 50 years
Pulmonary	None	Spontaneous pneumothorax Apical blebs
Skin/connective tissue	Lumbosacral dural ectasia	None
Family history/genetics	First-degree relative who meets criteria Presence of <i>FBN1</i> mutation, or high-risk haplotype in MFS family	None None

**Table 19.5** Revised Ghent Criteria for Making a Diagnosis of Marfan Syndrome**For a Diagnosis of Marfan Syndrome (MFS) (With No Family History):**

- (1) Aortic root dilatation ( $Z$  score  $\geq 2$ ) plus ectopia lentis
- (2) Aortic root dilatation ( $Z$  score  $\geq 2$ ) plus pathogenic *FBN1* mutation
- (3) Aortic root dilatation ( $Z$  score  $\geq 2$ ) plus Systemic Score  $\geq 7$  points (below)
- (4) Ectopia lentis plus pathogenic *FBN1* mutation with known aortic root diameter

**If Family History (FH) Present:**

- (5) Ectopia lentis plus FH of MFS, as defined above
- (6) Systemic Score ( $\geq 7$  points) plus FH of MFS
- (7) Aortic root dilatation ( $Z$  score  $\geq 2$  above 20 years old;  $\geq 3$  below 20 years) plus FH of MFS

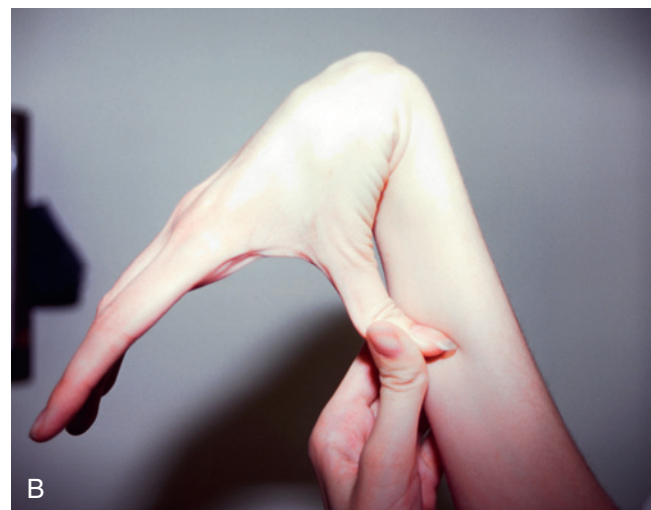
Systemic Score Feature	Points
Wrist AND thumb sign	3
Wrist OR thumb sign	1
Pectus carinatum deformity	2
Pectus excavatum or chest asymmetry	1
Hindfoot deformity	2
Plain pes planus	1
Pneumothorax	2
Dural ectasia	2
Protrusio acetabuli	2
Reduced upper segment/lower segment ratio AND increased arm/height ratio (AND no severe scoliosis)	1
Scoliosis or thoracolumbar kyphosis	1
Reduced elbow extension	1
Facial features (3/5 should be present): dolichocephaly, enophthalmos, downslanting palpebral fissures, malar hypoplasia, retrognathia	1
Skin striae	1
Myopia $>3$ diopters	1
Mitral valve prolapse (all types)	1

Reprinted with permission from Loeys BL, Dietz HC, Braverman AC, et al 2010 The revised Ghent nosology for the Marfan syndrome. *J Med Genet* 47: 476–485.

**Clinical Features**

MFS is a disorder of fibrous connective tissue, specifically a defect in fibrillin type 1, a glycoprotein encoded by the *FBN1* gene. In the classic presentation affected individuals are tall compared with unaffected family members, have joint laxity, a span:height ratio greater than 1.05, a reduced upper to lower segment body ratio, pectus deformity (Figure 19.20), and scoliosis. The connective tissue defect gives rise to ectopia lentis (lens subluxation) in a proportion of (but not all) families and, very importantly, dilatation of the ascending aorta, which can lead to dissection. The latter complication is obviously life threatening, and for this reason alone care must be taken over the diagnosis. Aortic dilatation may be progressive but the rate of change can be reduced by  $\beta$ -adrenergic blockade (if tolerated) and angiotensin-II receptor antagonists (similar properties to angiotensin-converting enzyme inhibitors). Surgical replacement should be undertaken if the diameter reaches 50–55 mm. Pregnancy is a risk factor for a woman with MFS who already has some dilatation of the aorta, and monitoring is very important.

A diagnosis of MFS requires careful clinical assessment, body measurements looking for evidence of disproportion, echocardiography, ophthalmic evaluation, and, in some doubtful cases, lumbar MRI to look for evidence of dural ectasia. Neither the metacarpophalangeal index, a radiological measurement of the ratio of these hand bone lengths, nor high-arched palate, are considered to have any diagnostic value. Where the family history is non-contributory, a positive



**FIGURE 19.20** **A**, An adolescent with Marfan syndrome showing disproportionately long limbs (arachnodactyly) and a very extreme example of chest bone deformity; he also has a dilated aortic root. **B**, Joint hypermobility at the wrist in a woman with Marfan syndrome; this appearance might also be seen in other joint-laxity conditions, such as Ehlers-Danlos syndrome.

diagnosis is made when the patient has a minimum of two major criteria plus involvement of a third organ system in the Ghent Criteria (see Table 19.4), but a slightly different system of assessment is proposed in the Revised Ghent Criteria (see Table 19.5).

### Genetics

MFS follows AD inheritance and the majority of cases are linked to the large *FBN1* gene on 15q21, with 65 exons spanning 200 kb and containing five distinct domains. The largest of these, occupying approximately 75% of the gene, comprises approximately 46 epidermal growth factor repeats (p. 204). Finding the causative mutations in affected patients was initially very difficult, but hundreds have now been reported. Most are missense and have a dominant-negative effect, resulting in less than 35% of the expected amount of fibrillin-1 in the extracellular matrix. Mutations have also occasionally been found in related phenotypes such as neonatal MFS, familial ectopia lentis, Shrintzen-Goldberg syndrome, and the MASS phenotype (mitral valve prolapse, myopia, borderline aortic enlargement, non-specific skin and skeletal findings).

### Congenital Contractural Arachnodactyly (CCA)—Beal Syndrome

This was probably the condition originally described by Antoine-Bernard Marfan in 1896. Many features overlap with MFS, but there is less tendency to aortic dilatation and its catastrophic consequences. Individuals have congenital contractures of their digits, a crumpled ear helix, and sometimes marked scoliosis. It is due to mutated **type 2 fibrillin** (*FBN2*), which shares the same organizational structure as fibrillin-1 and maps to 5q23.

### Loeys-Dietz Syndrome (LDS)

Familial aortic aneurysm is not confined to MFS and the most important ‘Marfan-like’ condition is LDS. This also follows AD inheritance and aneurysms can be aggressive and occur before major aortic dilatation—thus surgery is usually recommended when the measurement at the sinus of Valsalva reaches 4.5cm. Additional findings may include cleft palate or bifid uvula, craniosynostosis, mild learning disability, and generalized arterial tortuosity with aneurysms occurring elsewhere in the circulation. Some individuals have features overlapping with MFS—indeed many of these patients were assumed to have MFS prior to genetic testing—but they do not fully satisfy the accepted Ghent diagnostic criteria. Affected patients are more prone to simple hernia as well as having thin, atrophic scars indistinguishable from the type seen in Ehlers-Danlos syndrome. They do not, however, develop ectopia lentis. An unusual feature, and one that can be helpful in making a clinical diagnosis, is the presence of facial milia (Figure 19.21). These are small, pearly-white, keratin-filled cysts very similar to ‘milk spots’ seen in newborns (which are not permanent). In cases and families that were negative for *FBN1* testing the gene for LDS was identified through a candidate approach. Transforming growth factor (TGF) signaling (p. 105) had been shown to be important in vascular and craniofacial development in mouse models, which led Loeys and colleagues to sequence the TGF- $\beta$  receptor 2 (*TGFBR2*) gene in a number of families. Heterozygous mutations were found in most of these, and in the others missense mutations were found in the related gene, *TGFBR1*.



**FIGURE 19.21** Loeys-Dietz syndrome (LDS). A cluster of permanent, raised white spots seen below the right eyelid. These occur frequently in LDS and can be helpful in making a clinical diagnosis in conjunction with other features.

### Familial Thoracic Aortic Aneurysm Disease (FTAAD)

Clinical geneticists are commonly asked to assess patients with aortic root dilatation, aneurysm, or dissection, for features of MFS, especially if they are relatively young. Approximately 20% of individuals with TAAAD have an affected first degree relative, sometimes multiple affected relatives. In approximately 5% of TAAAD an associated finding is the presence of a bicuspid aortic valve (BAV), and BAV is common in the general population—to the extent of approximately 1%—and is frequently familial in its own right—approximately 20% of those requiring surgery have a positive family history.

Overall, barely a quarter of all FTAAD is accounted for by mutations in known genes, and in the era of next generation sequencing regular progress is being made in finding more. It is important to point out that *abdominal* aortic aneurysm is nearly always due to a combination of other factors such as age, smoking, hypertension, and atherosclerosis, though in younger people the possibility of Ehlers-Danlos syndrome (EDS) type IV (vascular type) should be considered. Common to all cases, however, is degeneration and breakdown of elastic fibers, and loss of smooth muscle cells—so-called ‘medial necrosis’.

The age of onset of FTAAD is very variable and may well be asymptomatic until a sudden catastrophic event such as dissection occurs. When suspected, therefore, regular screening of first degree relatives by echocardiography, MRI, or CT scan is indicated, and a judgement may be necessary about the timing of aortic root replacement surgery. After MFS, CCA, LDS, and EDS—vascular type (EDS-IV) are excluded, genetic testing in FTAAD is not at present very rewarding but is expected to improve. Mutations in *ACTA2* are occasionally seen where FTAAD is associated with BAV, and there are also reports of the *NOTCH1* gene being implicated in this scenario. Mutation of the *MYH11* gene, encoding a smooth muscle myosin heavy-chain protein, is occasionally seen and this is important because its locus is 16p13.11, and microdeletions affecting this region are associated with an increased risk of aortic dilatation. Mutations in *SMAD3* give rise to a syndromic form of FTAAD that resembles LDS—Loeys-Dietz syndrome

type 3—including early onset osteoarthritis, especially in the knees, spine and thumb base.

### Ehlers-Danlos Syndrome (EDS)

EDS is a family of connective tissue conditions typically characterized by the triad of joint hypermobility, skin hyperextensibility, and abnormal and delayed wound healing. When all aspects of this triad are florid in their manifestations the patient usually has EDS—Classic type, or EDS types I and II (combined) in the older classification (Table 19.6). Hyperextensible skin is illustrated in Figure 21.1, joint (wrist) hypermobility in Figure 19.20B, and skin features in Figure 19.22—respectively: loose skin, abnormal scars, and subcutaneous spheroids, which comprise calcified fibro-fatty lumps and may be seen in the Classic type (but not usually the Hypermobile type).

It is not possible here to do justice to the huge range of clinical features and complications that may occur as a consequence of these various tissue laxity/fragility disorders. It is important, however, to appreciate the following:

- Joint laxity is common in the general population, affecting perhaps 10% of adults and a third of children, but only when there are *no* accompanying problems or symptoms is it justified to diagnose ‘benign joint hypermobility syndrome’.

- Joint hypermobility is assessed using the Beighton score (Table 19.7), which has been shown to be reproducible and reliable, though it does not include all joints (e.g., shoulders, ankles).
- In clinical practice EDS-Hypermobile type (formerly EDS III, and *aka* ‘joint hypermobility syndrome’) is the most common entity encountered, and all other types of EDS are relatively rare.

Management of this group of disorders is far from easy and clinicians should be aware of the following:

- Where delayed healing and atrophic scarring is part of the disorder (e.g., EDS—Classic type) additional measures are required to ensure wound healing after trauma or surgery, i.e., sutures to remain for a longer period.
- EDS—Hypermobile type is usually accompanied, to a variable degree, by generalized chronic pain affecting the musculoskeletal system, chronic fatigue, and a range of autonomic nervous system dysfunction such as postural orthostatic tachycardia syndrome (POTS), reflux and irritable bowel syndrome (IBS), and poor temperature control (dysthermia); in addition, local anesthesia for dental procedures and pain management in labor is often only partially effective. Unfortunately, these aspects are not reflected in the diagnostic terms used.

**Table 19.6** The Villefranche Classification of Ehlers-Danlos Syndrome, Associated Genes (Where Known), and the Matching Terminology Used in the Former Classification

Villefranche Classification, 1997, With Major Criteria	Gene(s) and Inheritance Pattern	Former Classification
Classic Hyperextensible skin Atrophic scars Joint hypermobility	<i>COL5A1</i> , <i>COL5A2</i> AD	EDS type I (gravis) EDS type II (mitis)
Hypermobility Smooth, velvety skin (+/– hyperextensible) Joint hypermobility (+/– recurrent subluxations/dislocations)	Not known AD	EDS type III
Vascular Thin, translucent skin Arterial/intestinal/uterine fragility or rupture Extensive bruising Characteristic facial features (‘acrogeric’ appearance)	<i>COL3A1</i> AD	EDS type IV
Kyphoscoliotic Congenital and progressive scoliosis Scleral fragility, rupture of the ocular globe Joint hypermobility Hypotonia	<i>PLOD1</i> (Lysyl hydroxylase 1) AR	EDS type VI
Arthrochalasia Joint hypermobility (+/– recurrent subluxations/dislocations) Congenital bilateral hip dislocation	<i>COL1A1</i> , <i>COL1A2</i> (specific mutations) AD	
Dermatosparaxis Severe skin fragility Redundant, sagging skin	<i>ADAMTS2</i> AR	
<b>Rare Types Characterised Following Villefranche</b>		
Tenascin-X deficient	<i>TNXB</i> AR	
Kyphoscoliotic with myopathy and deafness	<i>FKBP14</i> AR	
Musculocontractural	<i>CHST14</i> AR	
With periventricular nodular heterotopia	<i>FLNA</i> XLD	





**FIGURE 19.22** Ehlers-Danlos syndrome. **A**, Loose skin over a knee joint; **B**, Thin, wide, atrophic scars, also over a knee joint; **C**, Subcutaneous spheroids on the medial aspect of this patient's heel.

- EDSIV carries life-threatening risks due to major arterial or organ rupture, and surgical management should be very carefully evaluated.

### Pseudoxanthoma Elasticum (PXE)

PXE is a specific connective tissue disorder, primarily affecting elastic tissue, which may present in a variety of ways because manifestations occur in the skin, eye, cardiovascular and gastrointestinal systems. Most commonly, clusters of papules—xanthoma-like lesions—occur in the neck and flexural regions

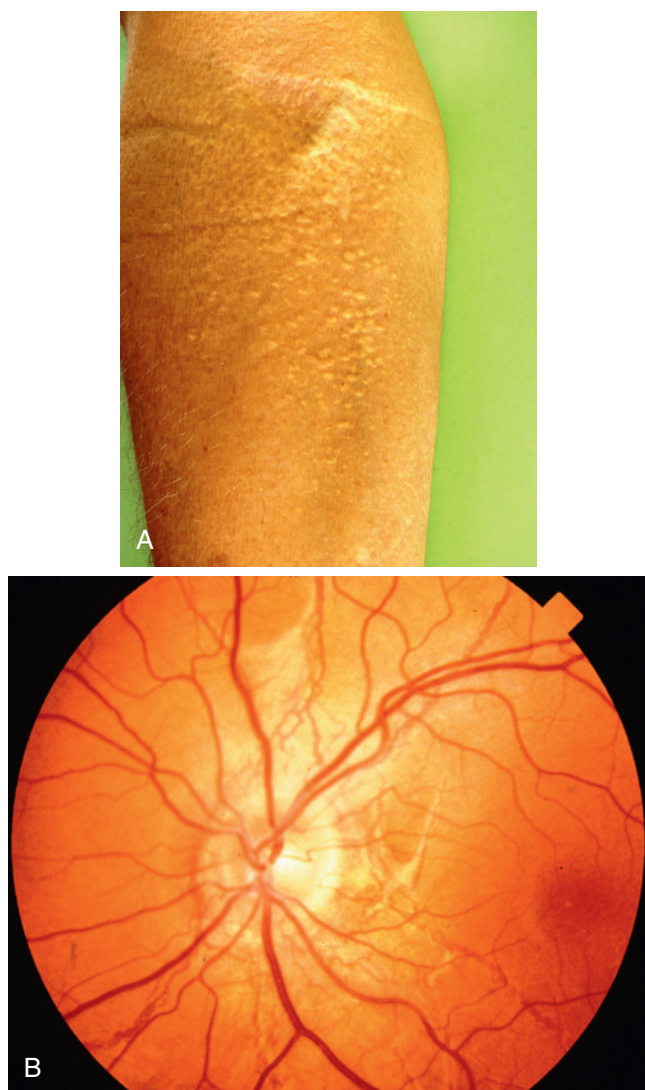
(Figure 19.23A), and angioid streaks may be seen on routine retinal examination (Figure 19.23B). It is normally diagnosed in adulthood and life expectancy is probably not reduced, though patients may suffer intermittent claudication pain and/or angina, gastrointestinal bleeding, and sometimes visual loss due to secondary retinal complications such as hemorrhage and scarring.

Skin biopsy shows calcification of fragmented elastic fibers. The condition follows autosomal recessive inheritance and only one gene is implicated, namely *ABCC6* (16p13.1), which encodes an ATP-binding cassette protein.

**Table 19.7** The Beighton Score for Assessing Joint Hypermobility

Feature/Range of Movement	Negative	Unilateral	Bilateral
Passive dorsiflexion of fifth finger >90°	0	1	2
Passive flexion of thumbs to the forearm	0	1	2
Hyperextension of elbows >190°	0	1	2
Hyperextension of knees >190°	0	1	2
Flexion of trunk, knees fully extended, palms resting on floor	0		1

A score of  $\geq 5$  indicates significant hypermobility.



**FIGURE 19.23** Pseudoxanthoma elasticum. **A**, Xanthoma-like lesions cluster in flexural areas such as the elbow and neck; **B**, angioid streaks are seen in the retinal fundus.

## Renal Disorders

The kidney is very frequently involved in genetic and hereditary disease, whether at the gross structural level, ultrastructural, or metabolic. Basic tests of renal function are conducted routinely in pediatric and adult medicine, and there is also usually a low threshold for performing imaging studies—ultrasonography initially. Renal involvement should therefore be considered in almost any setting when an unusual syndrome is diagnosed and, conversely, the diagnosis of an underlying syndrome should be considered when the primary presentation is renal.

### Dysmorphic Syndromes and Renal Involvement

All varieties of structural anomaly may occur across a very wide range of conditions. Renal agenesis may be part of branchio-oculo-facial (p. 115 and Figure 9.22, p. 116), deletion 22q11.2/DiGeorge (p. 245), Goldenhar (aka oculo-auriculo-vertebral spectrum, see Table 9.5, p. 117) and Kallmann (p. 245) syndromes, as well as diabetic embryopathy (p. 227). Ectopic or

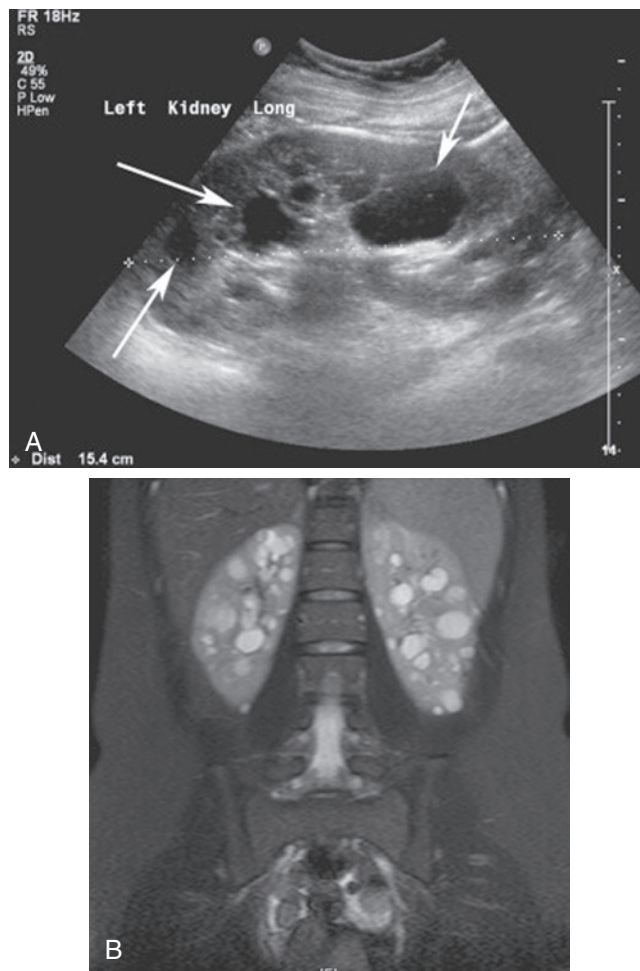
supernumerary kidneys have been reported in Baller-Gerold, Floating-Harbor, Peters plus, Schinzel-Giedion and CHARGE (p. 230) syndromes. Syndromic multiple cysts and/or dysplasia are a feature of TS (p. 280), Von Hippel-Lindau disease (p. 195), and renal cysts and diabetes (RCAD). Among the rarer conditions with cysts are Alagille (p. 107), Kaufman-McKusick, Meckel, Simpson-Golabi-Behmel (SGB), and Beckwith-Wiedemann (BWS) syndromes, as well as various ciliopathies (p. 115) such as Bardet-Biedl, Jeune and the short-rib polydactyly syndromes; and metabolic conditions including Zellweger syndrome and glutaric aciduria type II should not be forgotten. Enlarged kidneys may be part of BWS (p. 79), SGB, Perlman, and Proteus syndromes, as well as a number of metabolic disorders such as galactosialidosis, glutaric aciduria type II, and glycogen storage disease type I (p. 260).

It is important to appreciate, however, that there is great variability and overlap in these renal manifestations across different disorders; any combination of structural anomalies, multiple cysts/dysplasia and ectopic kidneys may occur in, for example, branchio-oto-renal (see Table 9.5, p. 117), Pallister-Hall (pp. 107, 112), oral-facial digital, Townes-Brocks, and RCAD syndromes, as well as the VATER/VACTERL (p. 219) and MURCS associations. Therefore, with a few exceptions, as a general rule there is little specificity or sensitivity in these structural anomalies and the findings on renal imaging, whether by ultrasound or MRI, can be challenging for the radiologist. However, the angiomyolipomas of TS can usually be distinguished (see Figure 11.4, p. 146), as well as the multiple cysts of autosomal dominant polycystic kidney disease (ADPKD), for example. It is also possible to distinguish cystic disease from the entity known as *renal cystic dysplasia*, which in most cases is probably a consequence of disruption events in early development, though occasional families showing autosomal dominant inheritance have been described.

### Autosomal Dominant Polycystic Kidney Disease

ADPKD is a common single gene disorder, probably affecting at least 1 in 1000 people and, because it leads to end stage renal disease (ESRD) by middle age (~50% by age 60), constitutes a significant burden on dialysis and transplantation services. The key feature is the progressive development and enlargement of bilateral renal cysts (Figure 19.24), detectable by ultrasound in at least 90% of sufferers by age 20. The development of hypertension and progression to ESRD is very variable, and indeed may not occur at all. It is also a multisystem disorder with hepatic and pancreatic cysts, intracranial arterial aneurysms, and sometimes mitral valve prolapse and aortic root dilatation, occurring. There is a significant risk of sub-arachnoid hemorrhage, highlighting the importance of treating hypertension effectively.

Two genes are associated with ADPKD—*PKD1* (16p13.3) and *PKD2* (4q22.1). Mutated *PKD1* accounts for approximately 85% of cases and, overall, is associated with more severe disease, and greater likelihood of ESRD, than *PKD2*. In clinical practice, however, genetic testing is seldom employed, partly because mutations tend to be ‘private’ to individual families but mainly because ultrasound is usually a straightforward method of making a diagnosis, especially in the context of a family history. *PKD1* happens to be very close at 16p13.3 to the *TSC2* gene (for tuberous sclerosis) and a contiguous gene deletion involving both gives rise to TS with severe polycystic kidneys, sometimes detectable in utero.



**FIGURE 19.24** Autosomal dominant polycystic kidney disease (ADPKD). **A**, Ultrasound of an enlarged left kidney in a child, showing multiple simple cysts (arrows) of varying size. **B**, In the same patient, a coronal T2 gradient echo image showing multiple renal cysts throughout both kidneys. (Reproduced from Allan PL, Baxter GM, Weston MJ 2011 *Clinical Ultrasound* 3 ed. Elsevier.)

### Autosomal Recessive Polycystic Kidney Disease (ARPKD)

As might be predicted, ARPKD is much rarer than ADPKD and also much more severe. It may present antenatally with oligohydramnios, which carries a significant risk of pulmonary hypoplasia and respiratory distress after delivery, but the majority of children are diagnosed in the neonatal period. Mortality in the first year is up to one-third but survival rates are much better for those who reach the second year of life. ESRD affects approximately 50% of children in the first decade. Apart from the renal aspects hepatobiliary disease is very common, giving rise to hepato-splenomegaly and eventually progressive portal hypertension due to periportal fibrosis. These long term complications are becoming more apparent as renal disease is more effectively managed, e.g., by transplantation, in survivors.

The kidneys are usually very enlarged so that ultrasonography is highly sensitive; it is also very specific with increased echogenicity and poor corticomedullary differentiation. These findings, together with evidence of hepatobiliary involvement,

are diagnostic. Thus far, only one gene is known for ARPKD—*PKHD1* (6p21). When the classic criteria are met molecular genetic testing is not essential for diagnosis but may be useful in mild cases where there is doubt, and if the parents request prenatal testing in subsequent pregnancies.

### Nephronophthisis (NPHP) and Medullary Cystic Kidney Disease (MCKD)

Nephronophthisis type 1 is an early onset disease and the most common genetic cause of renal failure in childhood; it follows autosomal recessive inheritance. It is caused by mutations in *NPHP1* (2q13) and is characterized by fibrosis and the formation of cysts at the medullary or corticomedullary junction (Figure 19.25). In fact, however, a host of loci for disorders featuring nephronophthisis are known; when this occurs in combination with retinitis pigmentosa this describes Senior-Loken syndrome, with cerebellar vermis hypoplasia Joubert syndrome (see Table 9.6, p. 117), and with encephalocele and polydactyly Meckel-Gruber syndrome (p. 224). As most of the proteins altered by the different genes localize to the cilium these disorders are rightly classed as ciliopathies (p. 115).



**FIGURE 19.25** Nephronophthisis and medullary cystic kidney disease. MR tomography of the kidneys in a patient with nephronophthisis type 1, showing multiple cysts at the corticomedullary junction. **A**, Axial view; **B**, coronal view. (Reproduced with permission from Geary DF, Schaefer F 2008 *Comprehensive Pediatric Nephrology*, 1 ed. Mosby Elsevier.)

Adult onset MCKD was once thought to be a late onset form of the same condition as what we now know as NPHP but, although there are overlapping features on renal ultrasound, it is a separate entity encoded by *MUC1* (1q22). It can give rise to hypertension, hyperuricemia, and gout, and ESRD may supervene around age 60.

### Alport Syndrome (AS)

AS is a thin basement membrane nephropathy due to abnormalities in type IV collagen and renal biopsy with electron microscopy is required to diagnose the features at an ultrastructural level. Renal disease is progressive, starting with microscopic hematuria, followed by proteinuria, deteriorating renal function and ESRD. Progressive high tone sensorineural hearing loss (SNHL) also occurs, usually symptomatic by late childhood or early adolescence, and in the eye a virtually pathognomonic form of anterior lenticonus, as well as maculopathy and corneal changes are evident.

Type IV collagen comprises six different chains, each encoded by its own gene. Abnormalities in three—*COL4A3*, *COL4A4*, and *COL4A5*—are implicated in AS. Of these, *COL4A5* is X-linked (XLAS) and accounts for approximately 80% of AS, with the rest split nearly equally between the other two (both on chromosome 2). XLAS is a serious disorder as all affected males eventually develop ESRD—approximately 90% by age 40—and approximately 90% develop SNHL. The hallmark in the early stage is persistent microscopic hematuria. ‘Carrier’ females are also significantly at risk, with greater than 90% showing microhematuria and approximately a third develop ESRD by age 60. Screening of those at risk, by urine testing, should commence in mid-childhood.

For the 20% of AS caused by mutated *COL4A3* or *COL4A4*, AR inheritance (ARAS) is approximately three times as common as AD, and the latter tends to follow a milder and slowly progressive course. It is potentially confusing, however, that approximately 50% of carriers of ARAS will show micro-

hematuria, so this test may not be helpful in trying to establish the pattern of inheritance.

### Renal Tubular Disorders

This encompasses a wide range of disorders affecting all aspects of mineral, ion, water and acid-base balance for which kidney function is key—indeed, a lot has been learned about normal renal physiology through their understanding. Individually, these various disorders are rare but awareness is important because many can be managed satisfactorily. A basic knowledge of normal renal ultrastructure is essential—from glomerulus to proximal tubule, to loop of Henle, to distal tubule, and finally collecting duct.

For one group of disorders in particular—those related to salt homeostasis—there is a vital interaction with the endocrine system, namely the adrenal gland, and these are included as they encompass most monogenic causes of hypertension. Salt wasting disorders are distinct. The disorders of water balance—failure of reabsorption—are known as nephrogenic diabetes insipidus, with 90% of cases being the XL form. The kidney is unable to respond to vasopressin (ADH), resulting in polyuria, polydipsia, failure to thrive and growth retardation—presenting in infancy usually. When the collecting duct fails to remove excess circulating acid into the urine this describes renal tubular acidosis, which is heterogeneous and sometimes a secondary consequence of various drugs. In addition to these conditions there are a number of different inherited, metabolic, stone-forming disorders, which include Dent disease and cystinuria, though the genetics of the latter is complex.

Although not an exhaustive list of conditions, the most important are summarized in [Table 19.8](#).

### Blood Disorders

The hemoglobinopathies have been covered elsewhere in [Chapter 12](#). There are of course numerous other rare inherited

**Table 19.8** Monogenic Renal Tubular Disorders

Condition	Gene(s) (Chromosome)	Inheritance	Biochemical Effect(s)	Clinical Effect(s)	Treatment
<i>Hypertensive/Salt-Retaining Disorders</i>					
Glucocorticoid-remediable aldosteronism (GRA)	<i>CYP11B2/CYP11B1</i> chimera (8q24)	AD	↑ Aldosterone ↓ Renin Mild ↓ potassium	Risk of cerebrovascular accident	Dexamethasone Spironolactone Amiloride
11-β hydroxylase deficiency	<i>CYP11B1</i> (8q24)	AR	Suppressed aldosterone ↓ Potassium ↑ Sex steroids	Virilisation	Dexamethasone
17-α hydroxylase deficiency	<i>CYP17A1</i> (10q24)	AR	Suppressed aldosterone ↓ Potassium ↓ Sex steroids	Primary amenorrhea Sexual infantilism	Dexamethasone
Liddle syndrome	<i>B</i> or <i>γ ENaC</i> (16p12)	AD	Suppressed aldosterone ↓ Renin Mild ↓ potassium	Mild hypertension	Amiloride
Pseudo-hypoaldosteronism type 2 (PHA2; Gordon syndrome)	Chrom. 7 [PHA2A] <i>WNK4</i> (17q21) [PHA2B] <i>WNK1</i> (12p13) [PHA2C] <i>KLHL3</i> (5q31) [PHA2D] <i>CUL3</i> (2q36) [PHA2E]	AD	↑ Potassium ↑ Chloride Acidosis	Short stature Dental anomalies	Thiazide diuretics

**Table 19.8** Monogenic Renal Tubular Disorders—cont'd

Condition	Gene(s) (Chromosome)	Inheritance	Biochemical Effect(s)	Clinical Effect(s)	Treatment
<b>Salt-Wasting Disorders</b>					
Pseudo-hypoaldosteronism type 1A (PHA1A)	<i>NR3C2</i> (4q31)	AD	↑ Potassium ↓ Sodium ↑ Aldosterone ↑ Renin	Neonatal vomiting/ dehydration	Symptomatic (improves with age)
Pseudo-hypoaldosteronism type 1B (PHA1B)	<i>ENaC</i> (16p12)	AD	Mild acidosis ↑ Potassium ↓ Sodium ↑ Aldosterone ↑ Renin	Neonatal vomiting/ dehydration (severe)	Aggressive symptomatic (may persist)
Gitelman syndrome	<i>SLC12A3</i> (16q13)	AR	Acidosis ↓ Potassium ↓ Magnesium ↓ Chloride Hypocalciuria	Weakness Tetany (Asymptomatic)	Magnesium & potassium supplements Thiazide diuretics
Bartter syndrome	<i>SLC12A1</i> (15q21) [Type 1] <i>KCNJ1</i> (11q21) [Type 2] <i>CLCNKB</i> (1p36) [Type 3] <i>BSND</i> (1p32) [Type 4A] Simultaneous <i>CLCNKA</i> & <i>CLCNKB</i> (1p36)	AR	↓ Potassium ↓ Chloride ↑ Aldosterone ↑ Renin Hypercalciuria (hypocalciuria in type 3) Alkalosis	Types 1 & 2: antenatal presentation with polyhydramnios Dehydration Failure to thrive Deafness in Type 4	Aggressive replacement of sodium & potassium Indomethacin
<b>Disorders of Water Balance</b>					
Nephrogenic diabetes insipidus	<i>AVPR2</i> (Xq28) <i>AQP2</i> (12q13)	XL AR, AD (rare)	↑ Sodium	Polyuria Polydipsia Vomiting Failure to thrive	Thiazide diuretics Amiloride Low sodium diet
<b>Renal Tubular Acidosis</b>					
RTA type 1, distal	<i>SLC4A1</i> (17q21)	AD	↑ Chloride Mild ↓ potassium Mild acidosis	Late onset Nephrolithiasis Nephrocalcinosis Mineral bone loss (Asymptomatic)	Citrate Bicarbonate
RTA type 2, proximal	<i>SLC4A4</i> (4q13)	AR	↑ Chloride Mild ↓ potassium Severe acidosis	Early onset Growth retardation Learning disability Corneal opacities	Bicarbonate +
RTA with deafness	<i>ATP6B1</i> (2p13)	AR	↑ Chloride ↓ Potassium Severe acidosis	Infancy or childhood Growth failure Vomiting/dehydration Progressive SNHL Rickets Nephrolithiasis	Citrate Bicarbonate
RTA with late onset deafness	<i>ATP6V0A4</i> (7q34)	AR	↑ Chloride ↓ Potassium Severe acidosis	Infancy or childhood Growth failure Vomiting/dehydration Progressive SNHL Rickets Nephrolithiasis	Citrate Bicarbonate
Osteopetrosis with RTA	<i>CA2</i> (8q21)	AR	↑ Acid phosphatase Mild acidosis	Learning disability Short stature Features of osteopetrosis	Bicarbonate
<b>Renal Stone-Forming Disorders</b>					
Dent Disease	<i>CLCN5</i> (Xp11)	XL	Hypercalciuria	Nephrolithiasis	Increased fluid intake Supportive measures
Cystinuria	<i>SLC3A1</i> (2p21) [Type A] <i>SLC7A9</i> (19q13) [Type B] <i>SLC3A1</i> & <i>SLC7A9</i> [Type AB]	AR, AD	Aminoaciduria— defective transport of cysteine and other dibasic amino acids in the proximal tubule	Nephrolithiasis	Increased fluid intake Dietary restriction of methionine and sodium Citrate Bicarbonate

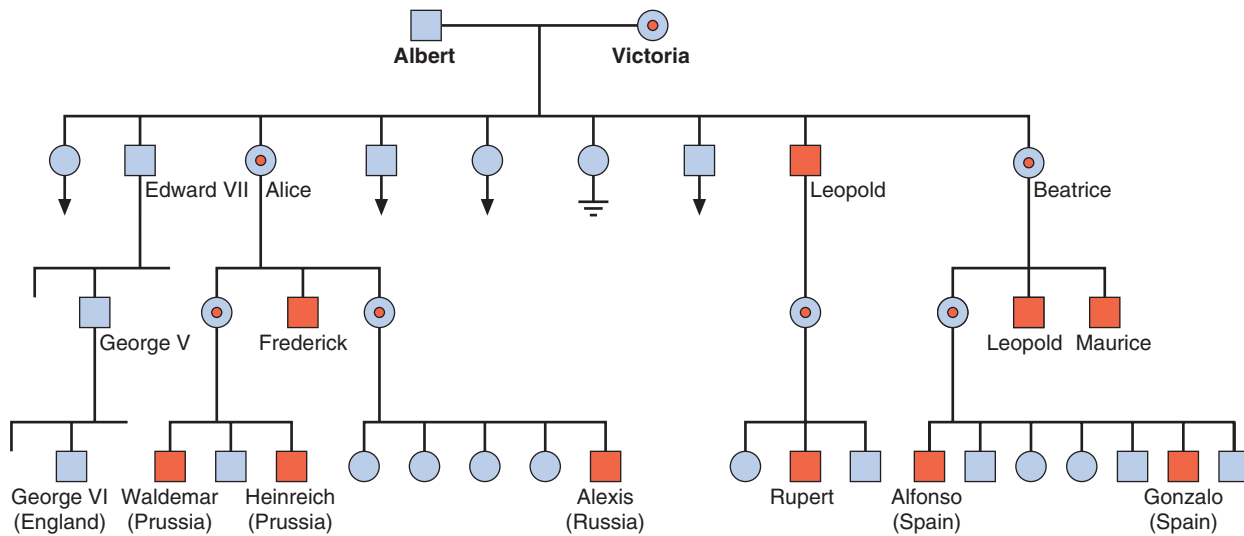


FIGURE 19.26 Pedigree showing the segregation of hemophilia among Queen Victoria's descendants.

blood disorders affecting different components and coagulation factors, and to conclude this chapter we confine ourselves to the most common and well-known one.

## Hemophilia

There are two forms of hemophilia: A and B. **Hemophilia A** is the most common severe inherited coagulation disorder, with an incidence of approximately 1:5000 males, caused by a deficiency of factor VIII. This, together with factor IX, plays a critical role in the intrinsic pathway activation of prothrombin to thrombin. Thrombin then converts fibrinogen to fibrin, which forms the structural framework of clotted blood. Historically, hemophilia was recognized in the Jewish Talmud, and 2000 years ago the religious authorities excused from circumcision the sons of the sisters of a mother who had given birth to an affected boy. Queen Victoria was a carrier and, as well as having an affected son—Leopold, Duke of Albany—she transmitted the disorder through two of her daughters—to most of the royal families of Europe (Figure 19.26).

**Hemophilia B** affects approximately 1:40,000 males and is caused by factor IX deficiency. It is also known as **Christmas disease** (after the first boy diagnosed at Oxford in 1952), whereas hemophilia A is sometimes referred to as 'classic hemophilia'.

## Clinical Features

These are similar in both forms of hemophilia and vary from mild bleeding following major trauma or surgery to spontaneous hemorrhage into muscles and joints. The clinical severity correlates closely with the reduction in factor VIII or IX activity. Levels below 1% are usually associated with a severe hemorrhagic tendency from birth. Hemorrhage into joints causes severe pain and swelling which, if recurrent, causes a progressive arthropathy with severe disability (Figure 19.27). Within families males with the disorder are generally affected to a similar degree.

The mainstay of treatment for both hemophilia A and B is replacement therapy. Clotting factor concentrates can be made from donated human blood but the purification process must be robust in order to prevent the transmission of viruses such as HIV/AIDS, which has been a problem in the past. A major

difficulty, however, is that antibodies can develop which destroy the clotting factor(s) from the outset. These antibodies, called inhibitors, develop in approximately a quarter of severe hemophilia A sufferers and up to 5% of those with hemophilia B. These conditions are therefore prime candidates for the

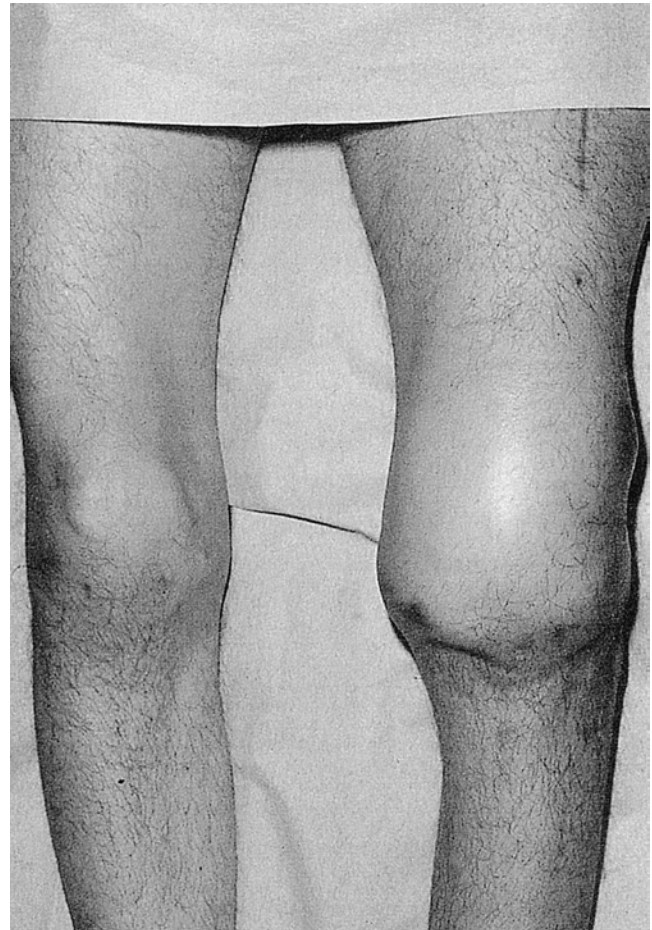
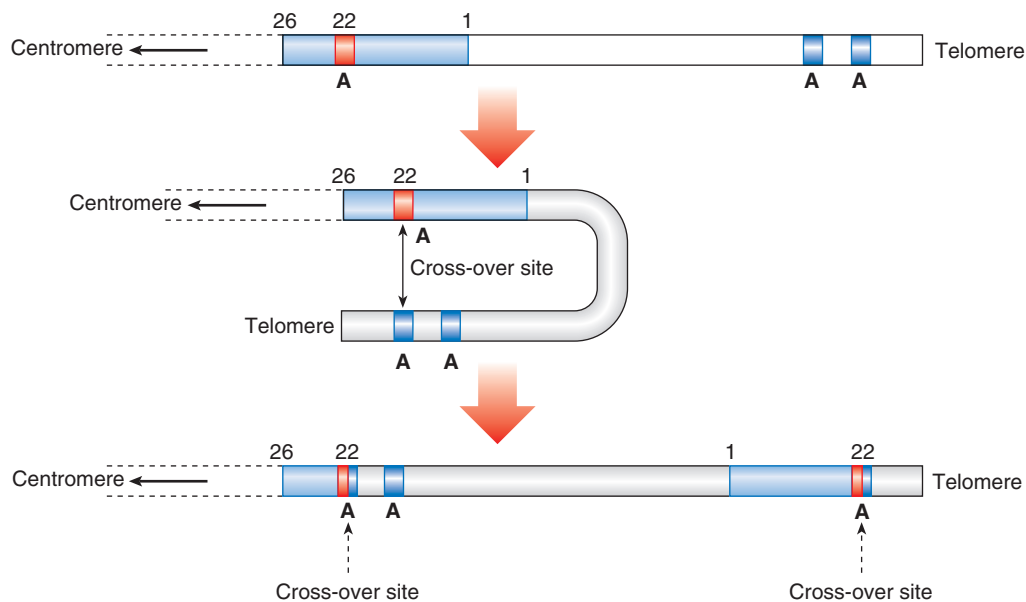


FIGURE 19.27 Lower limbs of a male with hemophilia showing the effect of recurrent hemorrhage into the knees. (Courtesy Dr. G. Dolan, University Hospital, Nottingham, UK.)



**FIGURE 19.28** How intrachromosomal recombination causes the ‘flip’ inversion, which is the most common mutation found in severe hemophilia A. (Adapted from Lakich D, Kazazian HH, Antonarakis SE, Gitschier J 1993 *Inversions disrupting the factor VIII gene are a common cause of severe hemophilia A. Nat Genet 5: 236–241.*)

development of novel therapies such as gene therapy, but thus far there has been no major breakthrough.

## Genetics

Both forms of hemophilia show X-linked recessive inheritance and the loci are close—Factor VIII at Xq28 and Factor IX at Xq27.1.

### Hemophilia A

The *factor VIII* gene comprises 26 exons and spans 186 kb with a 9-kb mRNA transcript. Deletions account for approximately 5% of all cases and usually cause complete absence of *factor VIII* expression. In addition, hundreds of frameshift, nonsense, and missense mutations have been described, besides insertions and an inversion of intron 22, which accounts for approximately one-sixth of all mutations and nearly 40% of mutations in severe cases (UK population). This is caused by recombination between a small gene called *F8A* located within intron 22 and homologous sequences upstream of the *factor VIII* gene (Figure 19.28). The inversion disrupts the *factor VIII* gene, resulting in very low factor VIII activity. The genetic test is straightforward but detection of the numerous other mutations requires direct sequencing.

As in DMD, point mutations usually originate in male germ cells whereas deletions arise mainly in the female. The intron 22 inversion shows a greater than 10-fold higher mutation rate in male compared with female germ cells, probably because Xq does not pair with a homologous chromosome in male meiosis—so that there is much greater opportunity for **intra-chromosomal** recombination to occur via looping of distal Xq (see Figure 19.28).

Factor VIII levels are approximately 50% of normal in carrier females, many of whom show a bleeding predisposition. Carrier detection used to be based on assay of the ratio of factor VIII coagulant activity to the level of factor VIII antigen but, as with CK assay in DMD, this is not always discrimina-

tory. Direct gene sequencing is now routine. Linkage analysis may occasionally be helpful in resolving carrier status.

### Hemophilia B

The factor IX (*F9*) gene comprises 8 exons and is 34 kb long. More than 800 different point mutations, deletions, and insertions have been reported but analysis of only 2.2 kb of the gene detects the mutation in 96% of cases. A rare variant form known as **hemophilia B Leyden** shows the extremely unusual characteristic of age-dependent expression. During childhood the disease is very severe, with factor IX levels of less than 1%. After puberty the levels rise to between 40% and 80% of normal and the condition resolves. Hemophilia B Leyden is caused by mutations in the promoter, and this so-called Leyden specific region (LSR) has been narrowed to approximately 50-bp between nucleotides –34 and +19, i.e., in the 5′ untranslated region of the *F9* gene. The mutations disrupt binding sites for certain enhancers/transcription factors, but the LSR also contains an androgen response element, and with the onset of puberty *F9* expression resumes and the effects of the mutation are bypassed.

## FURTHER READING

- Bates, G., Harper, P.S., Jones, L., 2002. *Huntington's disease*, third ed. Oxford University Press, Oxford.
- A comprehensive review of the clinical and genetic aspects of Huntington disease.*
- Emery, A.E.H., 2002. The muscular dystrophies. *Lancet* 359, 687–695.
- An excellent and succinct overview of the commonly encountered muscular dystrophies.*
- Emery, A.E.H., Emery, M.L.H., 2011. *The History of a Genetic Disease: Duchenne Muscular Dystrophy or Meryon's Disease*, second ed. Oxford University Press, Oxford.
- The definitive history of the first descriptions of Duchenne muscular dystrophy.*

Emery, A.E.H., Muntoni, F., 2003. Duchenne muscular dystrophy, third ed. Oxford University Press, Oxford.

*A detailed monograph reviewing the history, clinical features and genetics of Duchenne and Becker muscular dystrophy.*

Ferner, R.E., Huson, S., Evans, D.G.R., 2011. Neurofibromatoses in Clinical Practice. Springer-Verlag London Limited.

*A very thorough description of the different types of neurofibromatosis.*

Flinter, F., Maher, E., Saggart-Malik, A., 2003. The Genetics of Renal Disease. Oxford University Press, Oxford.

*A thorough and wide-ranging multi-author text.*

Harper, P.S., 2009. Myotonic Dystrophy (The Facts), second ed. Oxford University Press, Oxford.

*A comprehensive review of the clinical and genetic aspects of myotonic dystrophy.*

Loeys, B.L., Dietz, H.C., Braverman, A.C., et al., 2010. The revised Ghent nosology for the Marfan syndrome. *J. Med. Genet.* 47, 476–485.

*Essential reading for those seeking to make a diagnosis of Marfan syndrome using up-to-date criteria.*

## ELEMENTS

- 1 Huntington disease is an autosomal dominant disorder characterized by choreiform movements and progressive dementia. The disease locus has been mapped to the short arm of chromosome 4 and the mutational basis involves expansion of a CAG triple repeat sequence. Meiotic instability is greater in the male than in the female, which probably explains why the severe 'juvenile'-onset form is almost always inherited from a more mildly affected father.
- 2 Hereditary motor and sensory neuropathy (HMSN) includes several clinically and genetically heterogeneous disorders characterized by slowly progressive distal muscle weakness and wasting. HMSN-Ia, the most common form, is due to duplication of the *PMP22* gene on chromosome 17p, which encodes a protein present in the myelin membrane of peripheral nerve. The reciprocal deletion product of the unequal crossover leads to a mild disorder known as hereditary liability to pressure palsies.
- 3 The childhood forms of spinal muscular atrophy (SMA) are characterized by hypotonia and progressive muscle weakness. They show autosomal recessive inheritance and the disease locus has been mapped to chromosome 5q13. This region shows a high incidence of instability, with duplication of a 500-kb fragment containing *SMN* genes and a characteristic deletion in most patients.
- 4 Neurofibromatosis type I (NF1) shows autosomal dominant inheritance with complete penetrance and variable expression. The *NF1* gene is located on chromosome 17q and encodes a protein known as neurofibromin. This normally acts as a tumor suppressor by inactivating the RAS-mediated signal transduction of mitogenic signaling.
- 5 Duchenne muscular dystrophy (DMD) shows X-linked recessive inheritance, with most carriers being entirely healthy. The DMD locus lies at chromosome Xp21 and is the largest known gene in humans. The gene product, dystrophin, links intracellular actin with extracellular laminin. The most common mutational mechanism is a deletion that disturbs the translational reading frame.
- 6 Deletions that maintain the reading frame cause the milder Becker form of muscular dystrophy.
- 6 Myotonic dystrophy shows autosomal dominant inheritance and is characterized by slowly progressive weakness and myotonia. The disease locus lies on chromosome 19q and the mutation is the expansion of an unstable CTG triple repeat sequence. The range of meiotic expansion is greater in females, almost certainly accounting for the near-exclusive maternal inheritance of the severe 'congenital' form.
- 7 Cystic fibrosis (CF) shows autosomal recessive inheritance and is characterized by recurrent chest infection and malabsorption. The CF locus lies on chromosome 7, where the gene (*CFTR*) encodes the CF transmembrane receptor protein. This acts as a chloride channel and controls the level of intracellular sodium chloride, which in turn influences the viscosity of mucus secretions.
- 8 Inherited cardiac conditions (ICCs) have become a major area of clinical activity between geneticists and cardiologists. Sudden cardiac death can be due to a cardiomyopathy, an inherited arrhythmia, or connective tissue condition such as Marfan or Loeys-Dietz syndromes. In every case assessment and investigation of the immediate relatives is indicated.
- 9 Autosomal dominant polycystic kidney disease (ADPKD) is one of the most common single gene conditions. Diagnosis by ultrasound imaging is usually specific and genetic testing is seldom undertaken in routine practice. Besides the significant long term risk for a patient developing end stage renal disease, it is important to control blood pressure because there is also a risk of sub-arachnoid hemorrhage from rupture of a cerebral aneurysm.
- 10 Hemophilia A is the most common severe inherited coagulation disorder in humans. It shows X-linked recessive inheritance and is caused by a deficiency of factor VIII. The most common mutation in severe hemophilia A is caused by an inversion that disrupts the factor VIII gene at intron 22. Treatment with factor VIII replacement therapy is generally very effective.



## Prenatal Testing and Reproductive Genetics

Until relatively recently, couples at high risk of having a child with a genetic disorder had to choose between taking the risk or considering the options of long-term contraception, sterilization, or termination of pregnancy. Other alternatives included adoption or long-term fostering, and donor insemination (DI). But since the mid-1960s, when it first became possible to perform a karyotype on the unborn child, prenatal diagnosis, the ability to detect abnormalities in the fetus, has become a highly developed specialty—fetal medicine. The expert contribution of clinical geneticists in both diagnosis and counseling is now well established, though for all the advancement in medical science the decision to terminate a pregnancy is no less painful for the couple emotionally. The ethical issues in this field are considered in [Chapter 22 \(p. 325\)](#), whilst here the focus is on the practice of prenatal and reproductive genetics.

### Techniques Used in Prenatal Diagnosis

Several techniques and procedures are available for the prenatal diagnosis of fetal abnormalities and genetic disorders ([Table 20.1](#)).

#### Ultrasonography

Ultrasonography (US) is useful not only for obstetric indications, such as placental localization and the diagnosis of multiple pregnancies, but also for assessment of fetal size and the prenatal diagnosis of structural abnormalities. It is non-invasive and carries no known risk to the fetus or mother. High technology equipment in the hands of a skilled and experienced operator is increasingly sensitive. For example, polydactyly may be detected, which might be part of a multiple abnormality syndrome such as one of the autosomal recessive short-rib polydactyly syndromes associated with severe pulmonary hypoplasia—often lethal ([Figure 20.1](#)). Similarly, a scan can

*The more alternatives, the more difficult  
the choice.*

ABBE D'ALLAINVAL

reveal that the fetus has a small jaw, which can be associated with a posterior cleft palate and other more serious abnormalities in several single-gene syndromes ([Figure 20.2](#)).

Today, routine scanning is offered at around 12 weeks' gestation as part of early pregnancy assessment, including confirmation of the gestational age, and the fetal heart can be seen beating. An early view of body proportions provides early clues to fetal well-being, and a particular focus of attention is assessment of nuchal pad thickness, or **nuchal translucency (NT)**. Increased NT is seen in fetuses with Down syndrome and the measurement of the thickness of the nuchal pad ([Figure 20.3](#)) in the first and second trimesters is incorporated into the screening for Down syndrome ([p. 236](#)). In fact, the finding is not specific and may be seen in various chromosomal anomalies as well as isolated congenital heart disease. US at this early stage can detect a significant neural tube defect and other major anomalies. Thereafter, US is offered routinely to all pregnant women at around 18–20 weeks' gestation as further screening for structural abnormalities, as the fetus has grown to a size that makes visualization of much detail possible.

The future of fetal scanning holds the prospect of three-dimensional imaging, and magnetic resonance imaging (MRI), being used more widely and routinely. However, detection of subtle abnormalities of the developing brain may not be possible until 24–25 weeks' gestation, which is very late for making a decision about the pregnancy. Although fetal MRI will enable

**Table 20.1** Standard Techniques Used in Prenatal Diagnosis

Technique	Optimal Time (Wks)	Disorders Diagnosed
<b>Non-Invasive</b>		
MATERNAL SERUM SCREENING		
Triple test or combined test	10–14	Down syndrome
Ultrasound	18–20	Structural abnormalities (e.g., central nervous system, heart, kidneys, limbs)
<b>Invasive</b>		
Amniocentesis	16	
Fluid		Neural tube defects
Cells		Chromosome abnormalities, metabolic disorders, molecular defects
Chorionic villus sampling	10–12	Chromosome abnormalities, metabolic disorders, molecular defects
<b>Fetoscopy</b>		
Blood (cordocentesis)		Chromosome abnormalities, hematological disorders, congenital infection
Liver		Metabolic disorders (e.g., ornithine transcarbamylase deficiency)
Skin		Hereditary skin disorders (e.g., epidermolysis bullosa)

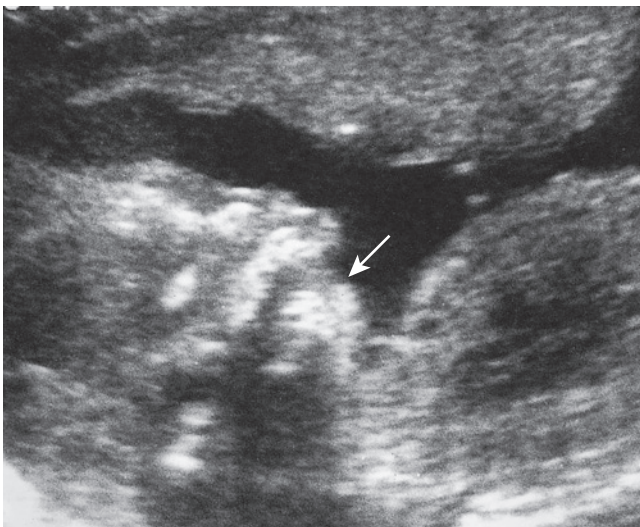


**FIGURE 20.1** Ultrasongraphic image of a transverse section of the hand of a fetus showing polydactyly.

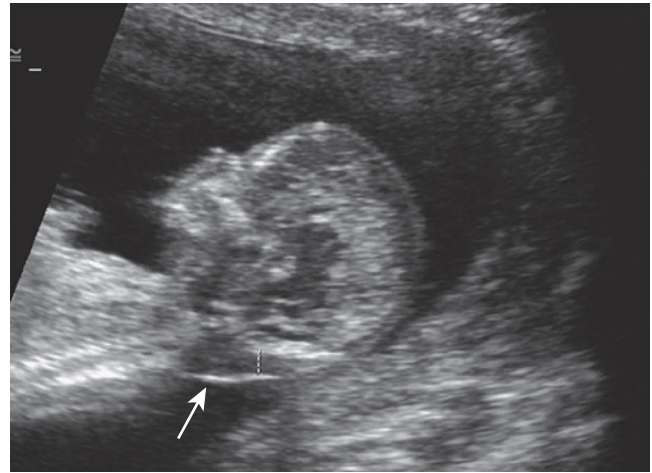
the unborn baby to be visualized in far greater detail, it will also generate bigger challenges for the dysmorphologist, who might be expected to diagnose serious disorders on the basis of very subtle features.

**Amniocentesis**

In amniocentesis 10 to 20 mL of amniotic fluid is aspirated through the abdominal wall under ultrasongraphic guidance (Figure 20.4), usually around the 16th week of gestation. The sample is spun down to yield a pellet of cells and supernatant fluid. The fluid was used to assay  $\alpha$ -fetoprotein to diagnose neural tube defects (p. 307) but US has superseded this method. The cell pellet is resuspended in culture medium to stimulate cell growth. Most cells in the amniotic fluid have

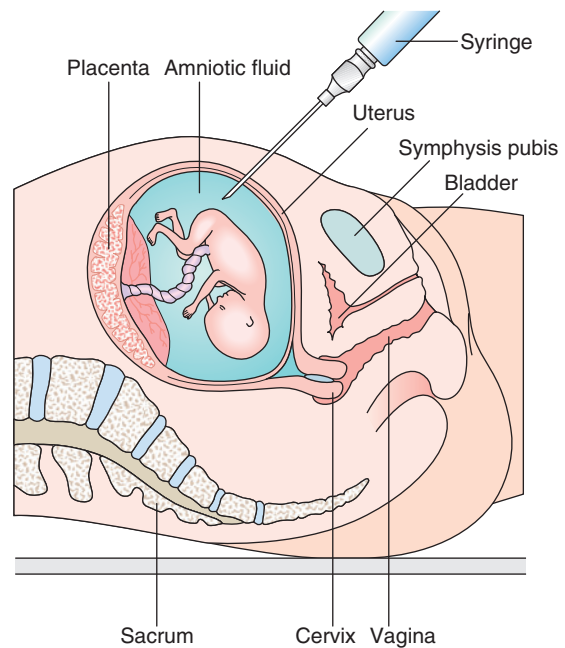


**FIGURE 20.2** Longitudinal sagittal ultrasongraphic image of the head and upper chest of a fetus showing micrognathia (small jaw) (arrow).

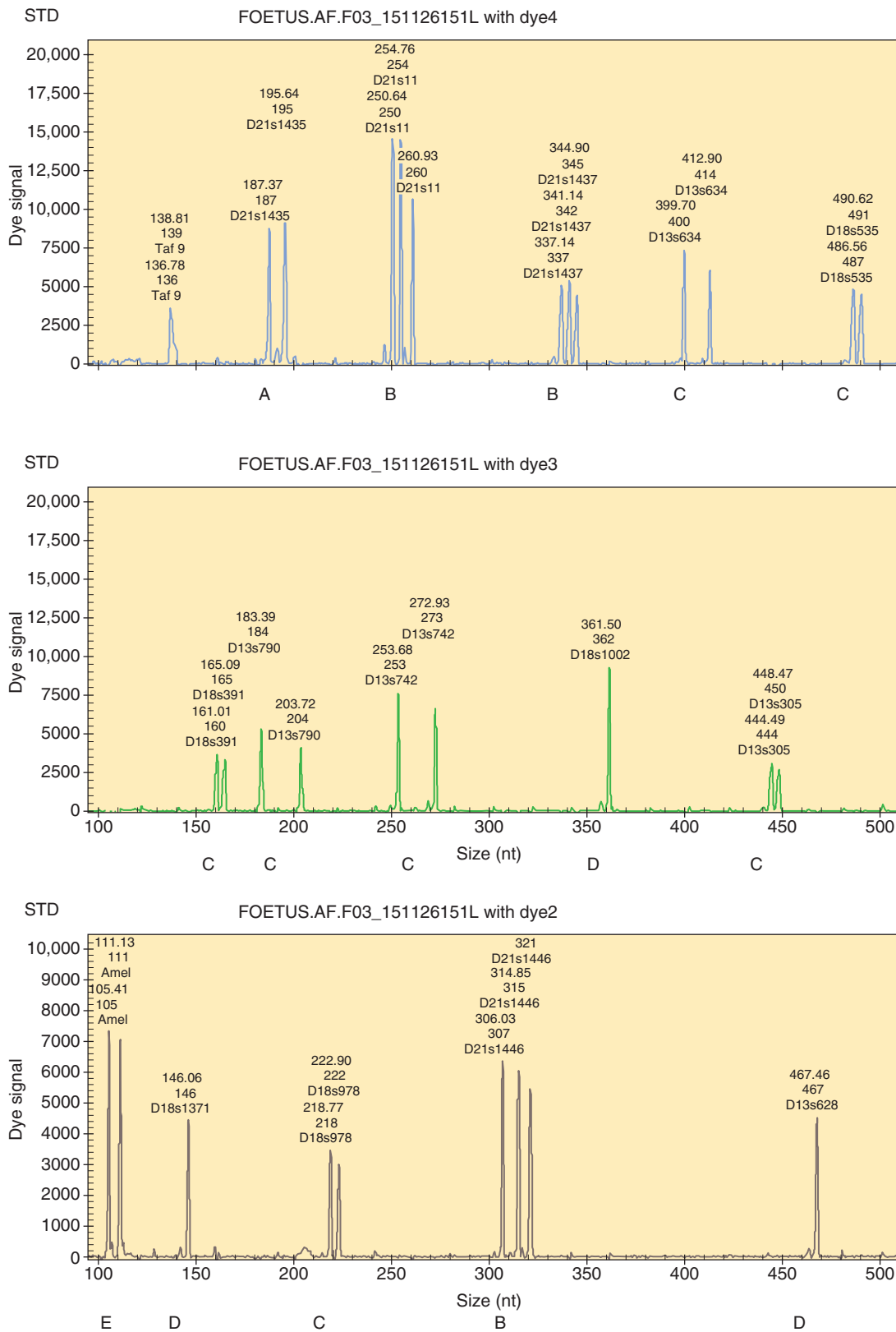


**FIGURE 20.3** Nuchal thickening—an accumulation of fluid at the back of the neck. The greater the thickness, the more likely there will be a chromosomal abnormality (e.g., Down syndrome) and/or cardiac anomaly. This finding leads to detailed fetal heart scanning and, usually, fetal karyotyping. (Courtesy Dr. Helen Liversedge, Exeter.)

been shed from the amnion, fetal skin, and urinary tract epithelium, and are non-viable, but some will grow. After approximately 14 days, there are usually sufficient cells for chromosome and DNA analysis, although a longer period may be required before enough cells are obtained for biochemical assays. Usually, direct DNA analysis using Quantitative Fluorescent PCR (QF-PCR) is performed at this stage to look for aneuploidies of chromosomes 13, 18, 21, X and Y. The assay uses fluorescent labelled primers to analyze up to five short tandem repeat markers from each chromosome after fragment length separation in capillary gel electrophoresis. The amount of fluorescence and size of the DNA is quantified and the ratios presented graphically (Figure 20.5), thus showing how many copies of the chromosomes are present. This rapid method of detecting



**FIGURE 20.4** Diagram of the technique of amniocentesis.



**FIGURE 20.5** A QF-PCR result for a fetus with Down syndrome, trisomy 21. (A), A biallelic marker for chromosome 21, with one peak twice the height of the other; (B), triallelic markers confirming a diagnosis of trisomy 21; (C), biallelic markers for chromosomes 13 and 18; (D), chromosome 18 markers—large peaks indicating two copies of this chromosome; (E), pseudoautosomal region markers (at Xp22 & Yp11) to determine gender (male in this case). (Courtesy of Bristol Genetics Laboratory.)

common aneuploidies may also detect abnormalities such as triploidy well before the karyotype is ready.

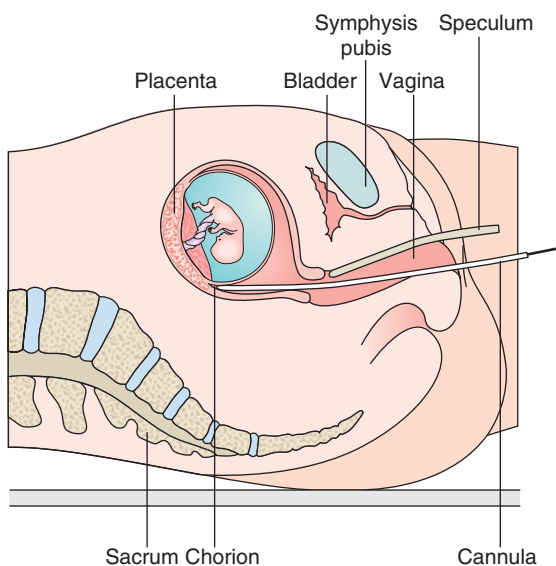
When a couple is considering amniocentesis, they should be informed of the 0.5% to 1% risk of miscarriage associated with the procedure, and if the result is abnormal they will face the possibility of a mid-trimester termination of pregnancy that involves induction of labor.

Trials of amniocentesis earlier in pregnancy, at 12 to 14 weeks' gestation, yielded comparable rates of success in obtaining results, with a similar risk of miscarriage. However, the volume of amniotic fluid at this early stage of pregnancy is low and early amniocentesis is not widely practiced. Although it would provide an earlier result, a mid-trimester termination of pregnancy is still required if the fetus is affected.

### Chorionic Villus Sampling (CVS)

In contrast to amniocentesis, CVS, first developed in China, enables prenatal diagnosis to be undertaken during the first trimester. This procedure is usually carried out at 11 to 12 weeks' gestation under ultrasonographic guidance by either transcervical or, more usually, transabdominal aspiration of chorionic villus (CV) tissue (see [Figure 20.6](#)). This tissue is fetal in origin, being derived from the outer cell layer of the blastocyst (i.e., the trophoblast), and goes on to form the placenta. Maternal decidua, usually present in the biopsy sample, must be removed before the sample is analyzed. **Placental biopsy** is the term used when the procedure is carried out at later stages of pregnancy. The CV sample is divided and one part set up in culture. From the other, DNA is extracted for analysis of the genetic disorder for which the fetus is at risk, i.e., a direct mutation test or, on occasion, a high risk set of haplotype markers. QF-PCR for the common aneuploidies is also usually performed, followed by a full karyotype analysis and report after culture. Sometimes the analysis is biochemical, e.g., for inborn errors of metabolism. This can usually be performed on the tissue sample but, if too small, will be undertaken after culture.

The risk of miscarriage from the procedure is usually quoted at 1%, though in the practice of experienced operators is usually lower.



**FIGURE 20.6** Diagram of the technique of transvaginal chorionic villus sampling.

### Fetoscopy

Fetoscopy involves visualization of the fetus by means of an endoscope. To a very large extent this technique has been superseded by detailed ultrasonography, other imaging techniques, and genetic testing to achieve a diagnosis. However, fetoscopy is still occasionally undertaken during the second trimester to examine the presence of subtle structural abnormalities that would point to a serious underlying diagnosis and to obtain specific biopsy samples in the diagnosis of certain rare disorders, for example the skin in conditions such as epidermolysis bullosa, and muscle in certain muscle disorders, where achieving a definitive diagnosis using molecular genetics may be elusive. Fetoscopy is also used when surgical interventions in the developing baby may prevent irreversible damage, for example the insertion of a drain in the urinary tract to prevent secondary damage from posterior urethral valves. Unfortunately, fetoscopy is associated with a 3% to 5% risk of miscarriage, so the decision must be very measured and the procedure performed only in specialized centers.

### Cordocentesis

Fetoscopy was previously used to obtain a small sample of fetal blood from one of the umbilical cord vessels in the procedure known as cordocentesis, but this is rarely required with the visualization now provided by modern ultrasonography. Fetal blood sampling is possible from around 20 weeks' gestation and is used routinely in the management of rhesus iso-immunization (p. 175), as well as some cases of non-immune fetal hydrops where a hemoglobinopathy is suspected. Occasionally, a sample for chromosome analysis may help to resolve problems associated with possible mosaicism in CV or amniocentesis samples.

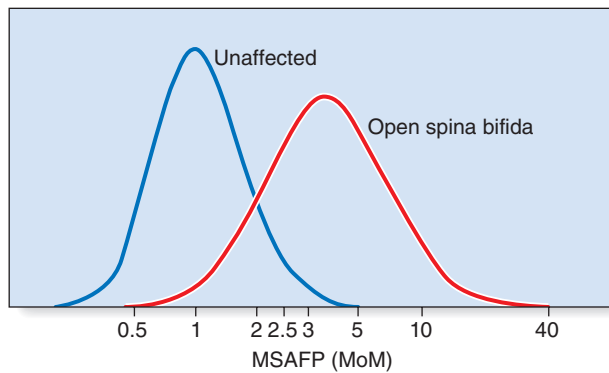
### Radiography

The fetal skeleton can be visualized by radiography from 10 weeks onwards, and this technique has been used in the past to diagnose inherited skeletal dysplasias. It may still be useful on occasion despite the widespread availability of high resolution ultrasonography.

### Prenatal Screening

The history of widespread prenatal (antenatal) screening really began with the finding, in the early 1970s, of an association between raised maternal serum  $\alpha$ -fetoprotein (AFP) and neural tube defects (NTDs). Estimation of AFP levels was gradually introduced into clinical service, and the next significant development was ultrasonography, followed in the 1980s by the identification of maternal serum biochemical markers for Down syndrome. These are discussed in more detail below. Where the incidence of a genetic condition was high, for instance thalassemia in Cyprus, prenatal screening came into practice, as described in [Chapter 11](#) (p. 151). However, molecular genetic advances, rather than biochemical, mean that the range of prenatal screening is continuing to evolve.

Testing for cystic fibrosis (CF) and fragile X syndrome are available in the UK, mainly for those willing to pay privately, and in Israel, for example, a wide range of relatively rare diseases can be screened for on the basis that they are more common in specific population groups that were originally isolates with multiple inbreeding, and therefore certain mutations are prevalent. Besides Tay-Sachs disease (carrier testing



**FIGURE 20.7** Maternal serum  $\alpha$ -fetoprotein (MSAFP) levels at 16 weeks' gestation plotted on a logarithmic scale as multiples of the median (MoMs). Women with a value of or above 2.5 multiples of the median are offered further investigations. (Adapted from Brock DJH, Rodeck CH, Ferguson-Smith MA [eds] 1992 *Prenatal diagnosis and screening*. Edinburgh: Churchill Livingstone.)

in this case is biochemical; see [Chapter 11](#)), familial dysautonomia, Canavan disease, Bloom syndrome, ataxia telangiectasia (North African Jews), limb-girdle muscular dystrophy (Libyan Jews) and Costeff syndrome (Iraqi Jews) are among the conditions for which screening is available. It does not come free of charge but the level of uptake of this screening is high, revealing the lengths to which some societies will go in order to avoid having children with serious genetic conditions. As techniques for DNA analysis develop and become affordable it is inevitable that screening will evolve, as the introduction of non-invasive methods on cell-free fetal DNA in the maternal circulation demonstrate (see below).

### Maternal Serum Screening

It has been government policy in the UK since 2001 that antenatal Down syndrome screening be available to all women, though it was introduced in the late 1980s. Where it is standard practice, maternal serum screening is offered for NTDs and Down syndrome using a blood sample obtained from the mother at 16 weeks' gestation. In this way up to 75% of all cases of open NTDs and 60% to 70% of all cases of Down syndrome can be detected.

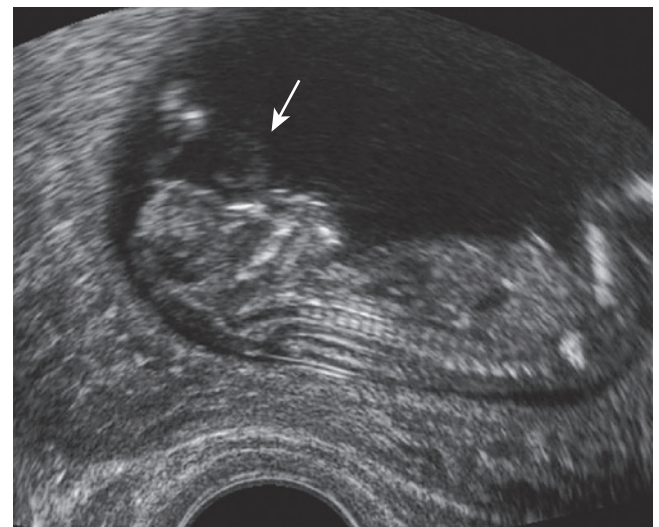
### Neural Tube Defects

In 1972 it was recognized that many pregnancies in which the baby had an open NTD ([p. 217](#)) could be detected at 16 weeks' gestation by assay of AFP in maternal serum. AFP is the fetal equivalent of albumin and is the major protein in fetal blood. If the fetus has an open NTD, the level of AFP is raised in both the amniotic fluid and maternal serum as a result of leakage from the defect. Open NTDs fulfil criteria for being serious disorders as anencephaly is invariably fatal and between 80% to 90% of the small proportion of babies who survive with an open lumbosacral lesion are severely disabled.

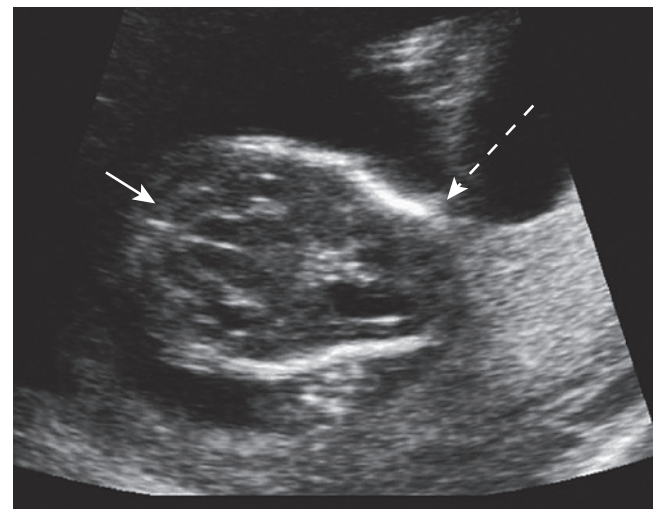
Unfortunately maternal serum AFP screening for NTDs is neither 100% sensitive nor 100% specific ([p. 148](#)). The curves for the levels of maternal serum AFP in normal and affected pregnancies overlap ([Figure 20.7](#)), so that in practice an arbitrary cut-off level has to be introduced below which no further action is taken. This is usually either the 95th centile, or 2.5 multiples of the median (MoM); as a result, around 75% of screened open spina bifida cases are detected. However, as

most women have fetal anomaly US scanning at around 18–20 weeks, this is usually sufficient to visualize and diagnose NTD, which has essentially superseded maternal serum screening for NTD. Anencephaly shows a dramatic deficiency in the cranium ([Figure 20.8](#)) and an open myelomeningocele is almost invariably associated with herniation of the cerebellar tonsils through the foramen magnum. This deforms the cerebellar hemispheres, which then have a curved appearance known as the 'banana sign'; the forehead is also distorted, giving rise to a shape referred to as the 'lemon sign' ([Figure 20.9](#)). A posterior encephalocele is readily visualized as a sac in the occipital region ([Figure 20.10](#)) and always prompts a search for additional anomalies that might help diagnose a recognizable condition, for example Meckel-Gruber syndrome.

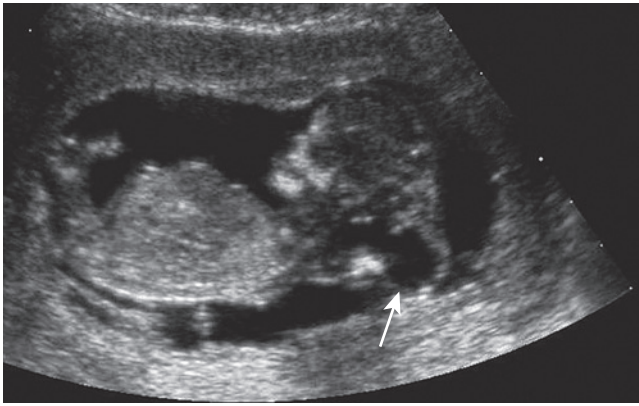
A raised maternal serum AFP concentration is not specific for open NTDs ([Box 20.1](#)). Other causes include threatened miscarriage, twin pregnancy, and a fetal abnormality such as



**FIGURE 20.8** Anencephaly (*arrow*). There is no cranium and this form of neural tube defect is incompatible with life. (Courtesy Dr. Helen Liversedge, Exeter, UK.)



**FIGURE 20.9** The so-called banana sign showing the distortion of the cerebellar hemispheres into a curved structure (*solid arrow*). The forehead is also distorted into a shape referred to as the 'lemon sign' (*broken arrow*). (Courtesy Dr. Helen Liversedge, Exeter, UK.)



**FIGURE 20.10** Posterior encephalocele (*arrow*), a more rare form of neural tube defect. This may be an isolated finding or associated with polydactyly and cystic renal changes in Meckel-Gruber syndrome. (Courtesy Dr. Helen Liversedge, Exeter, UK.)

exomphalos, in which there is a protrusion of abdominal contents through the umbilicus.

As a result of these screening modalities the birth incidence of open NTDs, which was 1 in 250 in 1973 in the UK, has dramatically fallen. Other contributory factors have been a general improvement in diet and the introduction of periconceptional folic acid supplementation (p. 224).

## Down Syndrome and Other Chromosome Abnormalities

### The Triple Test

Confirmation of a chromosome abnormality in an unborn baby requires cytogenetic or molecular studies using material obtained by an invasive procedure such as CVS or amniocentesis (pp. 304–305). However, chromosome abnormalities, and in particular Down syndrome, can be screened for in pregnancy by taking into account risk factors such as maternal age, the levels of biochemical markers in maternal serum (Table 20.2) and NT.

Biochemical markers are based on the discovery that, at 16 weeks' gestation, maternal serum AFP and unconjugated estriol levels tend to be *lower* in Down syndrome pregnancies compared with normal, whereas the level of maternal serum human chorionic gonadotropin (hCG) is usually raised. None of these parameters gives absolute discrimination, but taken together they provide a means of modifying a woman's prior age-related risk to give an overall probability that the unborn baby is affected. When this probability exceeds 1 in 150, invasive testing in the form of amniocentesis or placental biopsy is offered.

#### Box 20.1 Causes of Raised Maternal Serum AFP Level

- Anencephaly
- Open spina bifida
- Incorrect gestational age
- Intrauterine fetal bleed
- Threatened miscarriage
- Multiple pregnancy
- Congenital nephrotic syndrome
- Abdominal wall defect

On age alone, if all pregnant women aged 35 years and over opted for fetal chromosome analysis, approximately 35% of all Down syndrome pregnancies will be detected (Table 20.3). If three biochemical markers are also included (this being the so-called triple test), 60% of all Down syndrome pregnancies will be detected when a risk of 1 in 250 or greater is the cut-off for offering amniocentesis. This approach will also result in the detection of approximately 50% of all cases of trisomy 18 (p. 238). In the latter condition *all* the biochemical parameters are *low*, including hCG. By incorporating a fourth biochemical marker, inhibin-A, the proportion of Down syndrome pregnancies detected rises from 60% to 75% when amniocentesis is offered to the 5% of mothers with the highest risk.

Published results from California provide a useful indication of the outcome of a triple-test prenatal screening program. In a population of 32 million, all pregnant women were offered the triple-test. This was accepted by 67% of all eligible women, of whom 2.6% went on to have amniocentesis, resulting in the detection of 41% of all cases of Down syndrome. These figures are similar to those in other studies and illustrate the discrepancy between what is possible in theory (i.e., a detection rate of 60%) and what actually happens in practice.

### Ultrasonography

As mentioned, a routine 'dating' scan at around 12 weeks' gestation provides an opportunity to look for the abnormal accumulation of fluid behind the baby's neck—increased fetal NT (see Figure 20.3). This applies to Down syndrome, the other autosomal trisomy syndromes (trisomies 13 and 18;

**Table 20.2** Maternal Risk Factors for Down Syndrome

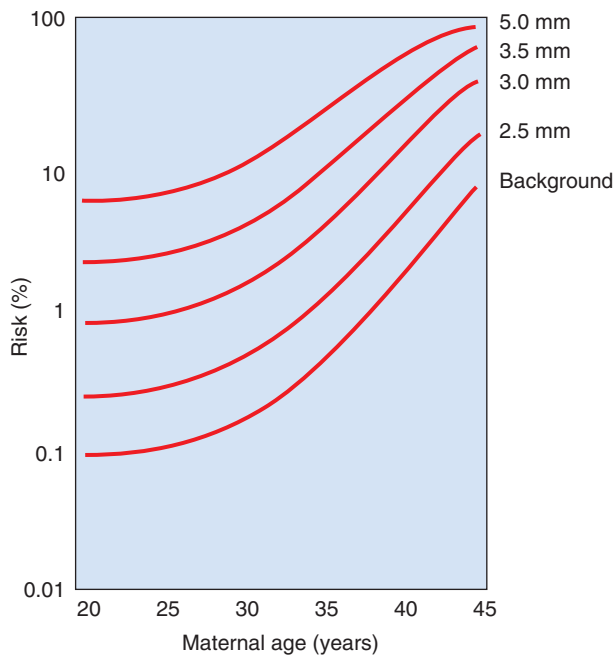
Advanced Age (35 y or Older) Maternal Serum	MoM*
α-Fetoprotein	(0.75)
Unconjugated estriol	(0.73)
Human chorionic gonadotrophin	(2.05)
Inhibin-A	(2.10)

\*Values in parentheses refer to the mean values in affected pregnancies, expressed as multiples of the median (MoMs) in normal pregnancies.

**Table 20.3** Detection Rates Using Different Down Syndrome Screening Strategies

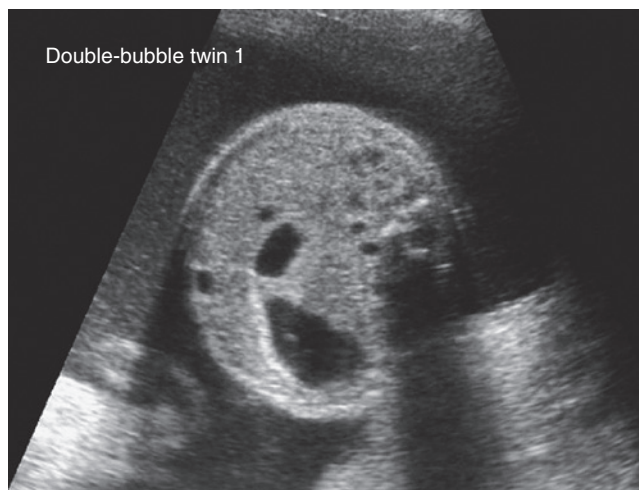
Screening Modality	All Pregnancies Tested (%)	Down Syndrome Cases Detected (%)
<i>Age Alone</i>		
40 years and older	1.5	15
35 years and older	7	35
Age + AFP	5	34
Age + AFP, μE3 + hCG	5	61
Age + AFP, μE3, hCG + inhibin-A	5	75
NT alone	5	61
NT + age	5	69
hCG, AFP + age	5	73
NT + AFP, hCG + age	5	86

AFP, α-Fetoprotein; hCG, human chorionic gonadotrophin; NT, nuchal translucency; μE3, unconjugated estriol.



**FIGURE 20.11** Risk for trisomy 21 (Down syndrome) by maternal age, for different absolute values of nuchal translucency at 12 weeks' gestation.

p. 238), Turner syndrome, and triploidy, as well as a wide range of other fetal abnormalities and rare syndromes. The risk for Down syndrome correlates with absolute values of NT as well as maternal age (Figure 20.11) but, because NT also increases with gestational age, it is more usual now to relate the risk to the percentile value for any given gestational age. In one study, for example, 80% of Down syndrome fetuses had NT above the 95th percentile. By combining information on maternal age with the results of fetal NT thickness measurements, together with maternal serum markers, it is possible to detect more than 80% of fetuses with trisomy 21 if invasive testing is offered to the 5% of pregnant women with the highest risk (see Table 20.3). These tests now usually take place between 10 and 14 weeks' gestation. Some babies with Down syndrome have duodenal atresia, which shows up as a 'double-bubble sign' on later US of the fetal abdomen (Figure 20.12).



**FIGURE 20.12** The 'double-bubble sign', suggestive of duodenal atresia, sometimes associated with Down syndrome. (Courtesy Dr. Helen Liversedge, Exeter, UK.)



**FIGURE 20.13** Ultrasonogram at 18 weeks showing exomphalos. (Courtesy Dr. D. Rose, City Hospital, Nottingham, UK.)

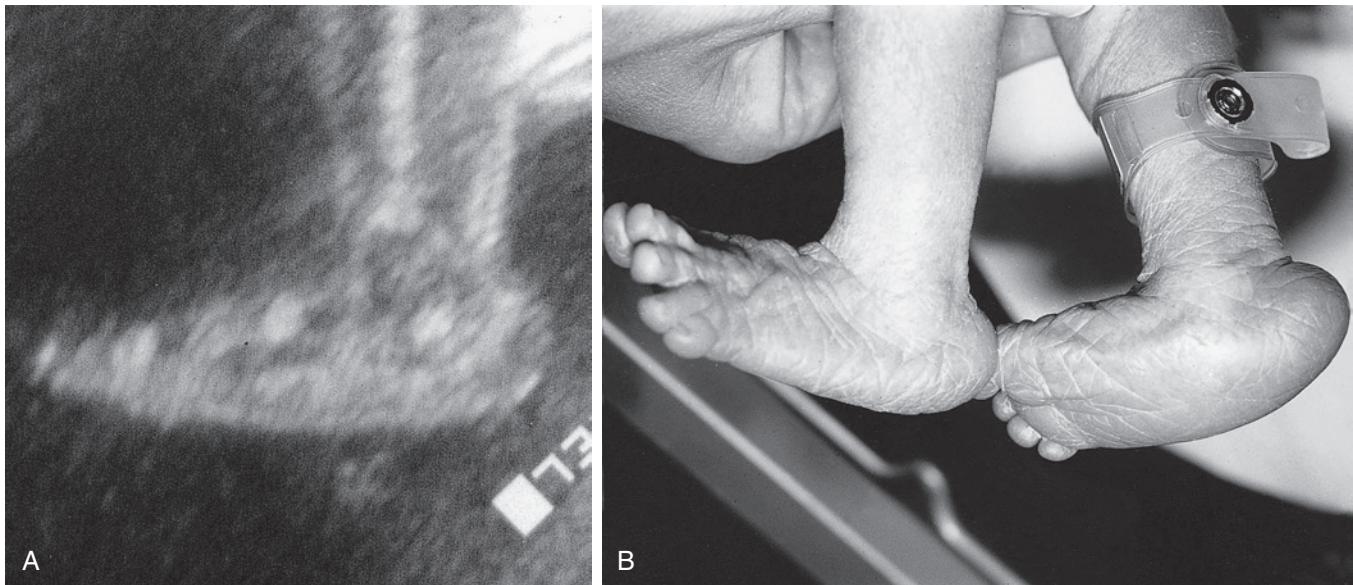
Fetal anomaly scanning, usually undertaken on all pregnancies around 18–20 weeks' gestation, may raise suspicion of chromosomal abnormalities, for example if exomphalos (Figure 20.13) or a rocker-bottom foot (Figure 20.14) (Table 20.4) is seen. A chromosome abnormality is found in 50% of fetuses with exomphalos identified at 18 weeks, and a rocker-bottom foot is characteristic, though not specific, for trisomy 18 (p. 238), in which growth retardation is invariable. The use of other ultrasonographic 'soft markers' in identifying chromosome abnormalities in pregnancy is discussed in the following section (p. 312).

### Indications for Prenatal Testing

Couples at high or increased prior risk of having a baby with an abnormality are usually offered prenatal testing and, ideally, they should come forward and be assessed before embarking on a pregnancy to allow for unrushed counseling and decision making. Certain orthodox Jewish communities are extremely well organized in this respect in relation to Tay-Sachs disease, as described in Chapter 11 (p. 145). In real life, all too often, many couples at increased risk because of their wider family history, or their own previous reproductive history, do not come forward, or are not referred, until pregnancy is underway. In some cases it may be too late to undertake the most thorough clinical and laboratory work-up in preparation for prenatal diagnosis.

### Advanced Maternal Age

This has been a common indication for offering prenatal testing on account of the well-recognized association between advanced maternal age and the risk of having a child with Down syndrome (see Table 17.4; p. 237), as well as other autosomal trisomies. No standard criterion exists for determining at what age a mother should be offered the option of an invasive procedure for fetal chromosome analysis. Most centers routinely offer amniocentesis or CVS to women age 37 years or older, and the option is often discussed with women from the age of 35 years. The risk figures relate to the maternal age at the expected date of delivery. The risk figures for Down syndrome at the time of



**FIGURE 20.14** **A**, Ultrasonogram at 18 weeks showing a rocker-bottom foot in a fetus subsequently found to have trisomy 18. **B**, Photograph of the feet of a newborn with trisomy 18. (Courtesy Dr. D. Rose, City Hospital, Nottingham, UK.)

CVS, amniocentesis, and delivery differ (p. 236) because a proportion of pregnancies with trisomy 21 are lost spontaneously during the first and second trimesters. Interestingly, despite industrial-scale efforts to screen for Down syndrome, the absolute numbers of Down syndrome births has changed very little over the period 1990–2010, though the number of prenatal diagnoses made has increased, which is attributed to the slightly older age at which women now have children (National Down Syndrome Cytogenetic Register). There may also be an increasing willingness to raise a child with the condition, and individuals with Down syndrome are living longer.

### Previous Child With a Chromosome Abnormality

Although there are a number of series with slightly different recurrence risk figures, for couples who have had a child with Down syndrome because of non-disjunction, or a de novo unbalanced Robertsonian translocation, the risk in a subsequent pregnancy is usually given as the mother's age-related risk plus approximately 1%. If one of the parents has been found to carry a balanced chromosomal rearrangement, such as a chromosomal translocation (p. 35) or pericentric inversion (p. 38), that has

caused a previous child to be born with serious problems due to an unbalanced chromosome abnormality, the recurrence risk is likely to be between 1% to 2% and 15% to 20%. The precise risk depends on the nature of the parental rearrangement and the specific segments of the individual chromosomes involved (p. 38).

### Family History of a Chromosome Abnormality

Couples may be referred because of a family history of a chromosome abnormality, most commonly Down syndrome. For most couples, there will usually be no increase in risk compared with the general population, as most cases of trisomy 21 and other chromosomal disorders will have arisen as a result of non-disjunction rather than as a result of a familial translocation, or other rearrangement. However, each situation should be evaluated carefully, either by confirming the nature of the chromosome abnormality in the affected individual or, if this is not possible, by urgent chromosome analysis of the parent at risk. If normal, an invasive prenatal diagnostic procedure is not then appropriate as the risk is no greater than that for the general population.

### Family History of a Single-Gene Disorder

If prospective parents have already had an affected child, or if one of the parents is affected or has a positive family history of a single-gene disorder that conveys a significant offspring risk, then the option of prenatal testing should be discussed with them. Prenatal diagnosis is available for a large and increasing number of single-gene disorders, usually by DNA sequencing.

### Family History of Congenital Structural Abnormalities

In keeping with standard clinical genetic practice, a carefully constructed family pedigree is fundamental and should enable a risk evaluation derived from the results of empiric studies. If the risk to a pregnancy is increased, and no genetic test can be offered, detailed fetal US can be offered from around 14 weeks' gestation. Mid-trimester US will detect most serious cranial, cardiac, renal and limb malformations. A positive

**Table 20.4** Prenatal Ultrasonographic Findings Suggestive of a Chromosome Abnormality

Feature	Chromosome Abnormality
Cardiac defect (especially common atrioventricular canal)	Trisomy 13, 18, 21
Clenched overlapping fingers	Trisomy 18
Cystic hygroma or fetal hydrops	Trisomy 13, 18, 21
Duodenal atresia	45,X (Turner syndrome) Trisomy 21
Exomphalos	Trisomy 13, 18
Rocker-bottom foot	Trisomy 18



finding does not always mean termination of pregnancy because the couple may simply wish to prepare themselves and will live with the consequences.

### Family History of Undiagnosed Learning Difficulty

An increasingly common scenario is the urgent referral of a pregnant couple who already has a child, or close relative, with an undiagnosed learning difficulty, with or without dysmorphic features. This will usually lead to urgent microarray-CGH (pp. 54, 245) testing of the index case, and fragile X syndrome testing if appropriate. Increasingly, next generation sequencing technology will be used in this scenario where the microarray-CGH test is normal and a single gene cause of learning difficulty is suspected. Where the couple already have a child with severe learning difficulty, for example, they may be desperate to know whether the recurrence risk is 1 in 4 because the condition follows autosomal recessive inheritance, or very low because of a *de novo* gene mutation.

### Abnormalities Identified in Pregnancy

The widespread introduction of prenatal screening has meant that many couples are faced with diagnostic uncertainty during the pregnancy that can be resolved only by an invasive procedure such as amniocentesis or CVS. Most anomalies, including poor fetal growth, are an indication for fetal QF-PCR, karyotype analysis and, increasingly, microarray-CGH. The finding of a serious and generally non-viable chromosome abnormality, such as trisomy 18 or triploidy (p. 238), usually leads to termination of the pregnancy. It is more usual, however, for such a decision to be very difficult because of the uncertainty of the long term outcome, depending on the diagnosis or anomaly identified. The close involvement and expertise of clinical genetics through this process, in providing prognostic information and associated counseling, must be emphasized.

### Other High-Risk Factors

These factors include parental consanguinity, a poor obstetric history, and certain maternal illnesses. Parental consanguinity increases the risk that a child will have a hereditary disorder or congenital abnormality (p. 70). Consequently, if the parents are concerned, it is appropriate to offer detailed US to try to exclude a serious structural abnormality. It may also be appropriate to offer to test the couple for CF and spinal muscular atrophy carrier status, and possibly other conditions depending on ethnicity and relevant family history. A poor obstetric history, such as recurrent miscarriage or a previous unexplained stillbirth, is also an indication for monitoring future pregnancies, including detailed US. A history of three or more unexplained miscarriages should prompt parental karyotype analysis to look for a chromosomal rearrangement such as a translocation or inversion (pp. 35, 37). Maternal illnesses, such as poorly controlled diabetes mellitus (p. 138) or epilepsy treated with anticonvulsant medications such as sodium valproate (p. 227), are also indications for detailed US because of the increased risk of structural fetal abnormalities.

### Special Problems in Prenatal Diagnosis

The significance of the result of a prenatal test is usually clear-cut, but situations can arise that pose major problems of interpretation. Problems also occur when the diagnostic investigation is unsuccessful or an unexpected result is obtained.

### Failure to Obtain a Sample or Culture Failure

It is important that every woman undergoing one of these invasive procedures is alerted to the possibility that, on occasion, it can prove impossible to obtain a suitable sample or the cells obtained subsequently fail to grow. Fortunately, the risk of either of these events occurring is less than 1%.

### An Ambiguous Chromosome Result

In approximately 1% of cases, CVS shows evidence of apparent chromosome mosaicism—i.e., the presence of two or more cell lines with different chromosome constitutions (p. 40). This can occur for several reasons:

1. The sample is *contaminated* by maternal cells. This is more likely to be seen in cultured cells than direct preparations.
2. The mosaicism is a **culture artifact**. Usually, more than one cell culture is established at the time of the procedure in order to help resolve this problem rapidly. If mosaicism is present in only one culture then it is probably an artifact, not reflecting the true fetal karyotype.
3. The mosaicism is limited to a portion of the placenta, or what is known as **confined placental mosaicism (CPM)**. This arises due to an error in mitosis during the formation and development of the trophoblast and is of no consequence to the fetus.
4. There is **true fetal mosaicism**.

In the case of amniocentesis, in most laboratories it is routine for more than one separate culture to be established. If a single abnormal cell is identified in only one culture, this is assumed to be a culture artifact, or what is termed **level 1 mosaicism**, or **pseudomosaicism**. If the mosaicism extends to two or more cells in two or more cultures this is taken as evidence of true mosaicism, or what is known as **level 3 mosaicism**. The most difficult situation to interpret is when mosaicism is present in two or more cells in only one culture, termed **level 2 mosaicism**. This is most likely to represent a culture artifact but there is up to a 20% chance of true fetal mosaicism.

To resolve the uncertainty of chromosomal mosaicism in cultured CV tissue it may be necessary to proceed to amniocentesis. If the latter test yields a normal chromosomal result, then it is usually concluded that the earlier result represented CPM.

Counseling in this situation may be extremely difficult. If true mosaicism is confirmed, it is often impossible to predict the phenotypic outcome for the baby. An attempt can be made to resolve ambiguous findings by fetal blood sampling for urgent karyotype analysis, but this too is limited in terms of the information it yields about the phenotype. Whatever option the parents choose, it is important that tissue (blood, skin, or placenta) is obtained at the time of delivery, whether the couple elects to terminate or continue with the pregnancy, to resolve the significance of the prenatal findings.

### An Unexpected Chromosome Result

Three different types of unexpected chromosome results may occur, each of which usually necessitates specialized and detailed genetic counseling.

### A Different Numerical Chromosomal Abnormality

Although most invasive procedures, i.e., CVS and amniocentesis, are carried out because of an increased risk of trisomy 21 through increased maternal age, or as a result of increased risk through the triple test or NT screening, a chromosomal abnormality other than trisomy 21 may be found, for example

another autosomal trisomy (13 or 18) or a sex chromosome aneuploidy (45,X, 47,XXX, 47,XXY, or 47,XYY). The sex chromosome aneuploidies present counseling challenges. It is very difficult to cover all the possible outcomes of the test at the time of the procedure—even the more common ones—so when a result such as Turner syndrome (45,X; p. 240) or Klinefelter syndrome (47,XXY; p. 239) is obtained it is essential that the parents are given full details of the nature and consequences of the diagnosis. When objective and informed counseling is available, less than 50% of the parents of a fetus with an ‘incidental’ diagnosis of a sex chromosome abnormality opt for termination of the pregnancy.

### A Structural Chromosomal Rearrangement

A second difficult situation is the discovery of an apparently balanced chromosome rearrangement in the fetus, such as an inversion or translocation. If analysis of parental chromosomes shows that one of the parents has the same structural chromosomal rearrangement, they can be reassured that this is very unlikely to cause problems in the child. If, however, this is a *de novo* event in the fetus, there is a 5% to 10% chance that the fetus has a subtle, unbalanced rearrangement with resulting physical abnormalities and/or developmental delay. Increasingly this may be resolved by microarray-CGH if available. It is also possible that damage to a critical gene at one or both of the rearrangement breakpoints has occurred, which would not be picked up by microarray. Couples facing this situation may have great difficulty in deciding what to do. Detailed ultrasonography, if normal, can provide some, but not complete, reassurance. Later on, the extended family should be investigated if the rearrangement is found to be present in one of the parents.

### The Presence of a Marker Chromosome

Another difficult situation is the finding of a small additional ‘marker’ chromosome, i.e., a small chromosomal fragment for which the specific identity cannot be determined by conventional cytogenetic techniques (p. 28). If this is found to be present in one of the parents, then it is unlikely to be of any significance to the fetus but, if *de novo*, there is up to a 15% chance that the fetus will be phenotypically abnormal. The risk is lower when the marker chromosome contains satellite material (p. 13), or is made up largely of heterochromatin (p. 25), than when it does not have satellites and is mostly made up of euchromatin (p. 25). The availability of FISH (p. 27) and microarray-CGH (p. 54) means that the origin of the marker chromosome can often be determined more specifically, which may help prognostic interpretation. The most common single abnormality of this kind is a marker chromosome 15.

### Ultrasonographic ‘Soft’ Markers

Sophisticated ultrasonography has resulted in the identification of subtle anomalies in the fetus, the significance of which are not always clear. For example, choroid plexus cysts are sometimes seen in the developing cerebral ventricles in mid-trimester (Figure 20.15). Initially, it was thought that these were invariably associated with the fetus having trisomy 18 but in fact they occur frequently in normal fetuses, although if large and not spontaneously resolving they may be associated with a chromosome abnormality.

Increased echogenicity of the fetal bowel (Figure 20.16) has been reported in association with CF—the prenatal equivalent of meconium ileus (p. 286). Initial reports suggested this

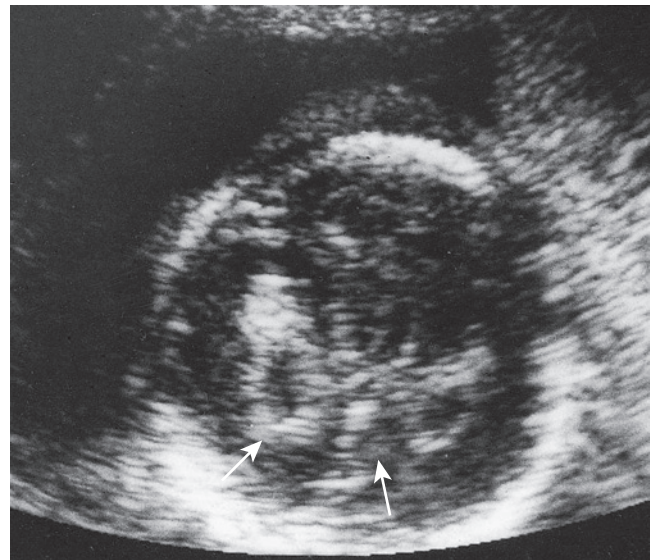


FIGURE 20.15 Ultrasonogram of a fetal brain showing bilateral choroid plexus cysts (arrows).

finding could convey a risk as high as 10% for the fetus having CF, but it is now clear that this risk is probably no greater than 1% to 2%. Novel ultrasonographic findings of this kind are often called **soft markers**, and a cautious approach to interpretation is appropriate, including serial scans.

### Termination of Pregnancy

The presence of a serious abnormality in a fetus in the majority of developed countries is an acceptable legal indication for termination of pregnancy (TOP). However, this is often a far from easy choice. All couples undergoing a prenatal test, whether invasive or non-invasive, should be provided with information about the practical aspects of TOP before the procedure is carried out. This should include an explanation that termination in the first trimester is carried out by surgical means under general anesthesia, whereas a woman undergoing a mid-trimester termination will have to experience labor and delivery.

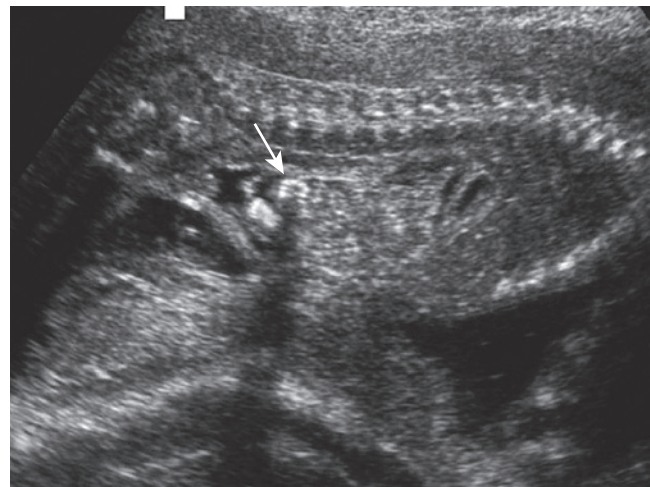


FIGURE 20.16 Echogenic bowel. Regions of the bowel showing unusually high signal (arrow). This is occasionally a sign of meconium ileus seen in cystic fibrosis. (Courtesy Dr. Helen Liversedge, Exeter, UK)

## Preimplantation Genetic Diagnosis

For many couples prenatal testing on an established pregnancy, with a view to possible termination, is too difficult to contemplate. For some of these **preimplantation genetic diagnosis** (PGD) provides an acceptable alternative. The second largest group of PGD users are those with subfertility or infertility who wish to combine assisted reproduction with genetic testing of the early embryo. In the procedure, the female partner is given hormones to induce hyperovulation, and oocytes are then harvested transcervically, under sedation and ultrasonographic guidance. Motile sperm from a semen sample are added to the oocytes in culture (**in vitro fertilization [IVF]**)—the same technique as developed for infertility) and incubated to allow fertilization to occur—or, commonly, fertilization is achieved using **intracytoplasmic sperm injection (ICSI)**.

At the eight-cell stage (blastocyst), the early embryo is biopsied and one, or sometimes two, cells (blastomeres) are removed for analysis. Whatever genetic analysis is undertaken, it is essential that this is a practical possibility on genomic material from a single cell, and in many cases an analysis using a genome amplification method called **multiple displacement amplification** and haplotype markers—**preimplantation genetic haplotyping**—has been the method of choice since it was pioneered in 2006. The technique reveals the parental origin of inherited alleles and reduces the vulnerability to contamination by extraneous DNA as well as the problem of allele dropout, thus significantly improving efficiency. From the embryos tested, one or two that are both healthy and unaffected by the disorder from which they are at risk are reintroduced into the mother's uterus. Implantation must then occur for a successful pregnancy and this is a major hurdle—the success rate for the procedure is only about 30% per cycle of treatment, even in the best centers. A variation of the technique is removal of the first, and often second, polar bodies from the unfertilized oocyte, which lie under the zona pellucida. Because the first polar body degenerates quite rapidly, analysis is necessary within 6 hours of retrieval. Analysis of polar bodies is an indirect method of genotyping because the oocyte and first polar body divide from each other during meiosis I and therefore contain different members of each pair of homologous chromosomes.

In the United Kingdom, centers must be licensed to practice PGD and are regulated by the Human Fertilization and Embryology Authority (HFEA). In numerical terms, the impact of PGD has been small to date, but a wide and increasing range of genetic conditions has now been tested (Table 20.5), with each one requiring a license. The most common referral reasons for single-gene disorders are CF, myotonic dystrophy, Huntington disease,  $\beta$ -thalassemia, spinal muscular atrophy, and fragile X syndrome. The technique for identifying normal and abnormal alleles in these conditions, and DNA linkage analysis, where appropriate, is PCR (p. 50). Sex selection in the case of serious X-linked conditions is permitted where single-gene analysis is not possible. The biggest group of referrals for PGD, however, is chromosome abnormalities—reciprocal and Robertsonian translocations in particular (pp. 35, 36).

In recent years, PGD has on rare occasions been used not only to select embryos unaffected for the genetic disorder for which the pregnancy is at risk, but also to provide a human leukocyte antigen tissue-type match so that the new child can act as a bone marrow donor for an older sibling affected by, for example, Fanconi anemia. The ethical debate surrounding these so-called 'savior sibling' cases is discussed further in Chapter 22.

**Table 20.5** Some of the Conditions for Which Preimplantation Genetic Diagnosis Has Been Used and Is Available

Mode of Inheritance	Disease	
Autosomal dominant	Charcot-Marie-Tooth	
	Familial adenomatous polyposis	
	Huntington disease	
	Marfan syndrome	
	Myotonic dystrophy	
	Neurofibromatosis	
	Osteogenesis imperfecta	
	Tuberous sclerosis	
	Autosomal recessive	$\beta$ -Thalassemia
		Cystic fibrosis
Epidermolysis bullosa		
Gaucher disease		
Sickle cell disease		
Spinal muscular atrophy		
Tay-Sachs disease		
X-linked		Alport syndrome
		Duchenne muscular dystrophy (DMD)
		Hunter syndrome
	Kennedy syndrome	
	Fragile X syndrome	
X-linked: sexing only	DMD	
	Ornithine transcarbamylase deficiency	
	Incontinentia pigmenti	
	Other serious disorders	
	Mitochondrial	MELAS
Chromosomal		Robertsonian translocations
		Reciprocal translocations
		Aneuploidy screening
		Inversions, deletions

MELAS, Mitochondrial myopathy encephalopathy, lactic acidosis, stroke.

A further development using micromanipulation methods has attracted a lot of attention. To circumvent the problem of devastating genetic disease resulting from a mutation in the mitochondrial genome (where the recurrence risk may be as high as 100%), the nucleus of the oocyte from the genetic mother (carrying the mitochondrial mutation) can be removed and inserted into a donor oocyte from which the nucleus had been removed. This is cell nuclear replacement technology, similar to that used in reproductive cloning experiments in animals ('Dolly' the sheep; see p. 330) and was legalized in the UK in 2015. The ethical controversy has been fuelled by the media sound bite 'Three-parent babies', even though the donor DNA amounts to 0.005% of the total. Part of the concern relates to the potential for matrilinear transmission of the donor mitochondria to future generations.

## Assisted Conception and Implications for Genetic Disease

### In Vitro Fertilization

Many thousands of babies worldwide have been born by IVF over the past 30 years, when the technique was first successful. The indication for the treatment in most cases is subfertility, which now affects one in seven couples. In some Western countries, 1% to 3% of all births are the result of assisted reproductive technologies (ARTs). The cohort of offspring conceived in this way is therefore large, and evidence is gathering that the risk of birth defects is increased by 30% to 40%

compared with the general population conceived in the normal way, with about 50% more children likely to be small for gestational age (SGA). Specifically, a small increase in certain epigenetic conditions due to defective genomic imprinting (p. 77) has been observed—Beckwith-Wiedemann (p. 79) and Angelman (p. 78) syndromes, and ‘hypomethylation’ syndrome, though the possible mechanisms are unclear. In cases studied, loss of imprinting was observed at the *KCNQ1OT1* locus (see Figure 6.27; p. 80) in the case of Beckwith-Wiedemann syndrome, and at the *SNRPN* locus (Figure 6.23; p. 78) in the case of Angelman syndrome. No apparent imprinting differences explain the increase in SGA babies conceived by ICSI.

Epigenetic events around the time of fertilization and implantation are crucial for normal development (p. 121). If there is a definite increased risk of conditions from abnormal imprinting after ARTs, this may relate, in part, to the extended culture time of embryos, which has become a trend in infertility clinics. Instead of transferring cleavage-stage embryos, it is now more routine to transfer blastocysts, which allows the healthier looking embryos to be selected. However, in animal models it has been shown that in vitro culture affects the extent of imprinting, gene expression, and therefore the potential for normal development.

### Intracytoplasmic Sperm Injection

As mentioned, this technique is commonly used as part of IVF when combined with PGD, but the main indication for directly injecting sperm into the egg is male subfertility because of low sperm count, poor sperm motility, abnormal sperm morphology, or mechanical blockage to the passage of sperm along the vas deferens. Chromosomal abnormalities or rearrangements have been found in about 5% of men for whom ICSI is suitable, and 10% to 12% in those with azoospermia or severe oligospermia. Examples include the Robertsonian 13:14 translocation and Y-chromosome deletions. For men with azoospermia or severe oligospermia the karyotype should be checked, including the application of molecular techniques looking for submicroscopic Y deletions. In those with mechanical blockage due to congenital bilateral absence of the vas deferens (CBAVD), a significant proportion have CF mutations. ICSI offers hope to men with CBAVD, as well as those with Klinefelter syndrome, following testicular aspiration of sperm.

Some of the chromosomal abnormalities in the men may be heritable—especially those involving the sex chromosomes—and there is a small but definite increase in chromosomal abnormalities in the offspring (1.6%).

### Donor Insemination

As a means of assisted conception to treat male infertility, or circumvent the risk of a genetic disease, **donor insemination** (DI) has been used since the 1950s. Only relatively recently, however, has awareness of medical genetic issues been incorporated into practice. Following the cases of children conceived by DI who were subsequently discovered to have balanced or unbalanced chromosome disorders, or in some cases CF (indicating that the sperm donor was a carrier for CF), screening of sperm donors for CF mutations and chromosome rearrangements has become routine practice in many countries. This was recommended only as recently as 2000 by the British Andrology Society. In the Netherlands, a donor whose sperm was used to father 18 offspring developed an autosomal dominant late-onset neurodegenerative disorder (one of the spinocerebellar ataxias), thus indicating that all 18 offspring were conceived at 50% risk.

This led to a ruling that the sperm from one donor should be used no more than 10 times, as against 25 before this experience. In the United Kingdom, men older than age 40 years cannot be donors because of the small but increasing risk of new germline mutations arising in sperm with advancing paternal age.

Of course, it is not possible to screen the donor for all eventualities, but these cases have served to highlight the potential conflict between treating infertility (or genetic disease) by DI and maintaining a high level of concern for the welfare of the child conceived. More high profile in this respect is the ongoing debate about how much information DI children should be allowed about their genetic fathers, and the law varies across the world. The issues apply equally to women who donate their ova.

### Assisted Conception and the Law

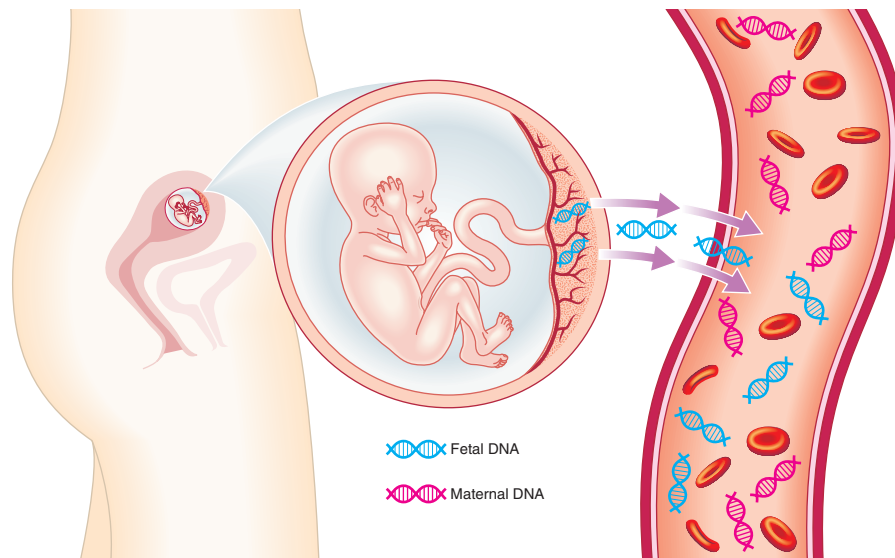
In the United States, no federal law exists to regulate the practice of assisted conception other than the requirement that outcomes of IVF and ICSI must be reported. In the United Kingdom, strict regulation operates through the HFEA based on the Human Fertilization and Embryology Act of 1990 (updated in 2008). The HFEA reports to the Secretary of State for Health, issues licenses, and arranges inspections of registered centers. The different licenses granted are for *treatment* (Box 20.2), *storage* (gametes and embryos), and *research* (on human embryos in vitro). A register of all treatment cycles, the children born by IVF, and the use of donated gametes, must be kept. The research permitted under license covers treatment of infertility, increase in knowledge regarding birth defects, miscarriage, genetic testing in embryos, the development of the early embryo, and potential treatment of serious disease.

### Non-Invasive Prenatal Testing (NIPT)

At the turn of the 19th century, it was discovered that fetal cells reach the maternal circulation, but confirmation that **cell-free fetal DNA** (cffDNA), derived from placental trophoblast tissue, is present in the plasma of pregnant women was not made until 1997 (Figure 20.17). This fact was initially exploited in clinical practice as early as 6 to 7 weeks of pregnancy to determine fetal sex by detection of Y-chromosome DNA sequences and the fetal Rhesus D gene. Early determination of fetal sex is clinically useful in a pregnancy at risk of an X-linked recessive disorder, and also in congenital adrenal hyperplasia. The problem with analyzing cffDNA is that of isolation because maternal cell-free DNA constitutes 80% to 90% of all cell-free DNA in the maternal circulation. The absence of Y-chromosome DNA might indicate that the fetus is female, or that the quantity of fetal DNA is very low. This is resolved by using

#### Box 20.2 Assisted Conception Treatments Requiring a License From the Human Fertilization and Embryology Authority

- In vitro fertilization
- Intracytoplasmic sperm injection
- Preimplantation genetic diagnosis
- Sperm donation
- Egg donation
- Embryo donation
- Surrogacy



**FIGURE 20.17** Minute quantities of cell-free fetal DNA reach the maternal circulation from the trophoblasts of the placenta and can be accessed for genetic analysis.

real-time PCR to quantify the amount of fetal or total DNA present in plasma.

Development of the technology to detect Down syndrome and other common trisomies in the fetus has been rapid. In this case the challenge lay in discriminating between a DNA sample in which the fetal component constitutes three copies of chromosome 21 as opposed to the two copies of the maternal plasma cell free DNA. This has been achieved using massive parallel 'shotgun' sequencing technology combined with sophisticated sequencing data analysis. Essentially, millions of small fragments of cffDNA (both random and specific to chromosomes of interest) from maternal plasma (containing both fetal and maternal cell-free DNA) are amplified and sequenced. The fragments are then mapped to the human genome and analyzed for their frequency, or density, along each chromosome, enabling detection of Down syndrome in the fetus where chromosome 21 fragments are over-represented, and likewise for the other common aneuploidies. Validation trials of the technique have shown an accuracy of greater than or equal to 99% and it is being introduced into prenatal screening. It has been calculated to be cost-effective when used to replace amniocentesis after maternal serum screening in the combined test has highlighted a 1:150 risk or greater for Down syndrome.

The attraction of a very accurate prenatal test that avoids an invasive procedure carrying a risk of fetal loss is obvious. As a result, the range of conditions for which tests will be developed will expand, and in fact is already available for achondroplasia (*FGFR3* gene) and some of the craniosynostosis conditions due to mutated *FGFR2*. Although there are inevitable concerns that the technology will make it possible to test the fetus for non-medical characteristics, or features, this is extremely unlikely given the bespoke nature of each individual assay. It does, however, dramatically change the face of prenatal testing and screening for the foreseeable future.

### Prenatal Treatment

This chapter has focused mainly on prenatal screening and testing for abnormalities, and this inevitably means that the option of termination of pregnancy is a possible outcome. For

the future there is cautious optimism that prenatal testing will, in time, lead to the possibility of effective treatment in utero, at least for some conditions.

A possible model for successful prenatal treatment is provided by the autosomal recessive disorder congenital adrenal hyperplasia (CAH) (p. 261). Affected female infants are often born with virilization of the external genitalia. There is evidence that in a proportion of cases virilization can be prevented if the mother takes a powerful steroid known as dexamethasone in a very small dose from 4 to 5 weeks' gestation onward. Specific prenatal diagnosis of CAH can be achieved by DNA analysis of CV tissue. If this procedure confirms that the fetus is both female and affected, the mother continues to take low dose dexamethasone throughout pregnancy, which suppresses the fetal pituitary-adrenal axis. If the fetus is male, even if affected, the mother ceases to take dexamethasone and the pregnancy proceeds.

Treatment of a fetus affected with severe combined immunodeficiency (p. 173) has also been reported. The immunological tolerance of the fetus to foreign antigens introduced in utero means that the transfused stem cells are recognized as 'self', with the prospect of good long-term results.

When gene therapy (p. 207) proves to be both safe and effective, the immunological tolerance of the fetus should make it easier to commence such therapy before birth rather than afterward. This will have the added advantage of reducing the period in which irreversible damage can occur in organs such as the central nervous system, which can be affected by progressive neurodegenerative disorders.

### FURTHER READING

- Allyse, M., et al., 2015. Non-invasive prenatal testing: a review of international implementation and challenges. *Int J Womens Health* 7, 113–126.
- Evans, M., 2006. *Prenatal diagnosis*. McGraw-Hill Professional.
- Odiibo, A., Krantz, D., 2010. *Prenatal screening and diagnosis, an issue of clinics in laboratory medicine*. Saunders.
- Pereira, E., Soria, J. (Eds.), 2010. *Handbook of prenatal diagnosis. Methods, issues and health impacts*. Nova Science Publishers Inc.

## ELEMENTS

- 1 Prenatal screening can be carried out by non-invasive methods such as maternal serum assays combined with nuchal translucency for Down syndrome, and ultrasonography for structural abnormalities.
- 2 Specific prenatal testing of chromosome and single-gene disorders usually requires an invasive technique, such as amniocentesis or chorionic villus sampling, by which material of fetal origin can be obtained for analysis.
- 3 Invasive prenatal testing procedures convey small risks for causing miscarriage (e.g., amniocentesis 0.5% to 1%, chorionic villus sampling 1% to 2%, cordocentesis 1% to 2%, fetoscopy 3% to 5%).
- 4 The most common indications for prenatal testing are advanced maternal age and an increased risk predicted from screening. Other indications include a previous, or family, history of a chromosomal or single-gene disorder, or an abnormal finding on ultrasound.
- 5 Although the significance of many prenatal diagnostic findings is clear, situations frequently arise in which the implications for the fetus are very difficult to predict, in which case the couple should be offered specialized genetic counseling.
- 6 Non-invasive prenatal testing on cell-free fetal DNA in the maternal circulation is beginning to change the approach to prenatal screening and testing.

## Genetic Counseling

Any couple that has had a child with a serious abnormality must inevitably reflect on why this happened and whether any child(ren) they choose to have in future might be similarly affected. Similarly, individuals with a family history of a serious disorder are likely to be concerned that they could either develop the disorder or transmit it to future generations. They are also very concerned about the risk that their normal children might transmit the condition to their offspring. For all those affected by a genetic condition that is serious to them, great sensitivity is needed in communication. Just a few words spoken with genuine caring concern can put patients at ease and allow a meaningful session to proceed; just a few careless words that make light of a serious situation can damage communication irrevocably. The importance of confidence and trust in the relationship between patient and health professional must never be underestimated, just as confidence is crucial to contractual business in the commercial world.

Realization of the needs of individuals and couples, together with awareness of the importance of providing them with accurate and appropriate information, has been a key factor in the establishment of clinical genetics and genetic counseling.

### Definition

Since the first introduction of genetic counseling services approximately 50 years ago, many attempts have been made to devise a satisfactory and all-embracing definition. All can agree that it is a process of communication and education that addresses concerns relating to the development and/or transmission of a hereditary disorder.

An individual who seeks genetic counseling is known as a **consultand**. During the genetic counseling process, it is widely agreed that the counselor should try to ensure that the consultand is provided with information that enables him or her to understand:

1. The medical diagnosis and its implications in terms of prognosis and possible treatment
2. The mode of inheritance of the disorder and the risk of developing and/or transmitting it
3. The choices or options available for dealing with the risks.

It is also agreed that genetic counseling should include a strong communicative and supportive element, so that those who seek information are able to reach their own fully informed decisions without undue pressure or stress (Box 21.1).

#### Box 21.1 Steps in Genetic Counseling

Diagnosis—based on accurate family history, medical history, examination, and investigations  
 Risk assessment  
 Communication  
 Discussion of options  
 Long-term contact and support

Q. What's the difference between... a doctor... and God?

A. God doesn't think He's a doctor.

ANON

### Establishing the Diagnosis

Establishing a diagnosis is central to the genetic consultation. If incorrect, inappropriate and totally misleading information could be given, with potentially tragic consequences. However, counseling skills may be greatly tested when both the diagnosis and risk are uncertain.

Reaching a diagnosis in clinical genetics usually involves the three steps fundamental to any medical consultation: taking a history, carrying out an examination, and undertaking appropriate investigations. Often, detailed information about the consultand's family history will have been obtained by a skilled genetic nurse counselor. A full and accurate family history is a cornerstone in the whole genetic assessment and counseling process. Further information about the family and personal medical history often emerges at the clinic, when a full examination can be undertaken and appropriate investigations initiated, which often means microarray-CGH and/or appropriate gene analysis, and referral to specialists in other fields, such as neurology, cardiology and ophthalmology. Good quality genetic counseling usually depends on multidisciplinary input to help reach an accurate diagnosis.

Many disorders show **etiologic heterogeneity**, for example hearing loss and non-specific intellectual disability, both of which could be environmental or genetic in causation. If routine genetic tests and the family history are uninformative counseling often relies on empirical risks (p. 100), though these are rarely as satisfactory as risks based on a precise and specific diagnosis.

A disorder shows **genetic heterogeneity** if it can be caused by more than one genetic mechanism (p. 100). Many such disorders are recognized, and counseling can be extremely difficult if the heterogeneity extends to different modes of inheritance. Common examples include sensorineural hearing impairment, retinitis pigmentosa, Charcot-Marie-Tooth disease (p. 275), and connective tissue conditions including the various forms of Ehlers-Danlos syndrome (Figure 21.1). All can show autosomal dominant, autosomal recessive, and X-linked recessive inheritance, and in some cases mitochondrial (Table 21.1). Increasingly, gene panel tests for specific groups of genetic conditions, e.g. inherited eye disease such as retinitis pigmentosa (Figure 21.2), provide genetic diagnoses, though also increasingly generate confusion when a variant of unknown significance (VUS) is identified. These findings pose counseling challenges, both before taking a sample at the stage of explaining the test and when giving results. The challenge may relate



**FIGURE 21.1** Ehlers-Danlos syndrome. The inheritance pattern in this case is autosomal dominant because father and son are affected.

to both the risk assessment and to communication of risk if there is a lack of certainty.

### Calculating and Presenting the Risk

Calculating and communicating recurrence risk may be straightforward if the pedigree information is very clear, even if the precise diagnosis is not. However, factors such as variable age of onset, reduced penetrance, the finding of a VUS, and conditions demonstrating digenic inheritance, can make risk calculation more complex. But communicating risk is far more than simply conveying a numerical figure or percentage. Decision-making in the face of a risk is usually a multifaceted process, so as a working rule of thumb, recurrence risks should be quantified, qualified, and placed in context.

### Quantification—The Numerical Value of a Risk

Many people struggle to understand the basic concepts of risk, especially different ways of expressing it, such as a form of

**Table 21.1** Hereditary Disorders that Can Show Different Patterns of Inheritance

Disorder	Inheritance Patterns
Cerebellar ataxia	AD, AR
Charcot-Marie-Tooth disease	AD, AR, XR
Congenital cataract	AD, AR, XR
Ehlers-Danlos syndrome	AD, AR, XR
Ichthyosis	AD, AR, XR
Microcephaly	AD, AR
Polycystic kidney disease	AD, AR
Retinitis pigmentosa	AD, AR, XR, M
Sensorineural hearing loss	AD, AR, XR, M

AD, Autosomal dominant; AR, autosomal recessive; M, mitochondrial; XR, X-linked recessive.

odds or as a percentage. Thus, a risk of 1 in 4 for autosomal recessive disease can be presented as an odds ratio of 3 to 1 against, or numerically as 25%. Consistency and clarity are important to avoid confusion, and it is essential to emphasize that the risk applies to *each* pregnancy and that chance has no memory. For parents who have just had a child with an autosomal recessive disorder, this does not mean their next three children will be unaffected. A tossed coin has no memory whether it landed heads or tails at the last throw!

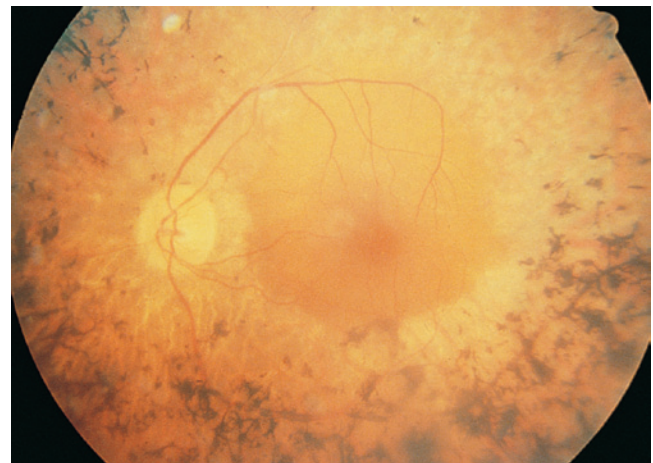
It is also important that genetic counselors are not seen as prophets of doom. The flip side of risk can be emphasized, so that if the empiric recurrence risk for bilateral cleft lip and palate is approximately 4%, it follows that there is a 96% chance that the problem will not occur next time.

### Qualification—The Nature of a Risk

In making risk-based decisions studies have shown that the numerical risk value is a less important factor than the nature, or *burden* of health issues associated with the diagnosis. Thus, a 'high' risk of 1 in 2 for a trivial problem such as partial cutaneous syndactyly of toes 2–3 will not deter parents. However, a 1% germline mosaicism risk for a condition such as tuberous sclerosis will often be sufficient for parents to request prenatal testing. Other factors, such as whether a condition can be treated successfully, whether it is associated with pain and suffering, and whether there was experience of bullying in childhood, may all be relevant to decision-making.

### Placing Risks in Context

Prospective parents seen at a genetic counseling clinic should be provided with information that enables them to put the risk in context so as to be able to decide for themselves whether it is 'high' or 'low'. For example, it can be helpful (but also alarming) to point out that approximately 1 in 40 of all babies has a congenital malformation (often treatable) or disabling disorder. Therefore, an additional quoted risk of 1 in 50, although initially alarming, might on reflection be perceived as relatively low. As an arbitrary guide, risks of 1 in 10 or greater tend to be regarded as high, 1 in 20 or less as low, and intermediate values as moderate.



**FIGURE 21.2** Fundus showing typical pigmentary changes of retinitis pigmentosa. (Reproduced with permission from Yanoff M, Duker JS 2014 *Ophthalmology* 4 ed. Elsevier.)



## Discussing the Options

Having established the diagnosis and discussed the occurrence/recurrence risk, the counselor should provide all relevant information necessary for the individual/couple to make informed decisions of their own. If relevant, the availability of prenatal diagnosis should be discussed, together with details of the procedures, timing, limitations, and associated risks (see Chapter 20). If appropriate, assisted reproductive options should be mentioned, including gamete donation and preimplantation genetic diagnosis (p. 313). These techniques can be used when one partner is infertile, e.g., for Klinefelter or Turner syndromes (see Chapter 17), or to bypass a genetic problem in one or both partners.

These issues should be presented very sensitively. For some, the prospect of prenatal diagnosis followed by selective termination of pregnancy is unacceptable, whereas others see this as their way of having healthy children. Whatever the personal views of the counselor, patients are entitled to full information about the prenatal options and procedures that are technically feasible and legally permissible.

## Communication and Support

The ability to communicate is essential in genetic counseling and is a two-way process. Apart from providing information, the counselor should seek to be receptive to patients' fears and aspirations, expressed or unexpressed. Good listening skills are vital to the consultation, as well as an ability to present information in a clear, sympathetic, and appropriate manner, with cultural sensitivity.

Often an individual or couple will be emotional and upset when a genetic diagnosis is made, and guilt feelings may ensue. It is normal for them to look back and scrutinize every event and happening, for example during a pregnancy. The presentation of potentially difficult information must therefore take into account the complex psychology and emotion that may affect the session. The setting should be peaceful and comfortable, with adequate time for discussion and questions. Where possible, technical terms should be avoided, or carefully explained. Questions should be answered openly and honestly, including for areas of uncertainty relating to the diagnosis and results. Most patients understand that there are limitations, and some parents of children without a diagnosis can accept that their child is special and has bamboozled the medical profession (unfortunately, this is not particularly difficult).

Despite every effort, a counseling session may be intense and the weight of information overwhelming. For this reason, patients should receive a letter, and sometimes additional written material, following the session. They may also be contacted later by a counselor, which provides an opportunity to clarify difficult or confusing issues. Patients and couples who have received complex and sometimes distressing information, for example in relation to prenatal diagnosis or presymptomatic testing for Huntington disease (p. 274), should be offered the opportunity for further contact and support. Most centers provide this through a team of genetic nurse counselors.

## Patient Support Groups

Lay-led disease-specific support organizations are usually established by highly motivated and well-informed parents or affected families, and provide an enormously valuable role. When confronted by a new and rare diagnosis many families feel very isolated, especially as most health professionals know

little about their particular disorder, and greatly value contact with others having similar experiences. Referral to an appropriate support group should be offered as a routine, though motivated individuals quickly make progress through the internet and social media. Many well organized groups successfully fund research and help to initiate new services.

## Genetic Counseling—Directive or Non-Directive?

Genetic counseling is a process of communication that provides information, the goal being to ensure that an individual or couple reach their own decisions with full knowledge of risks and options. There is overwhelming agreement that genetic counseling should be non-directive, with no attempt being made to steer the consultand along a particular course of action. In the same spirit the genetic counselor should be non-judgmental, even if a decision reached seems ill-advised or is contrary to the counselor's own beliefs. The counselor therefore facilitates and enhances autonomy rather than prescribing a particular course of action. This *person-centered* approach conforms most closely to the model of counseling theory developed by the American, Carl Rogers (1902–1987), rather than the *psychodynamic* approach of Sigmund Freud (1856–1939). If counselors are asked what they would do if facing the patient's situation it is generally preferable to avoid being drawn into expressing an opinion. Instead, the counselor can help the consultand to imagine the consequences, and how they might feel, if different options were pursued. This is 'scenario-based decision counseling' and encourages careful reflection, which is particularly important when decisions have irreversible consequences. It is the patients and their families who have to live with the consequences of their decisions, and they should be encouraged to make the decision that they can best live with—the one they are least likely to regret.

## Outcomes in Genetic Counseling

The issue of defining outcomes in genetic counseling is difficult and contentious, partly because of its rather nebulous nature and the difficulty in defining quantifiable end points, but also because of the pressure on healthcare funding. Despite this, the importance of counseling expertise is increasingly recognized in relation to explaining, and consenting, the complexities of whole exome sequencing, as well as interpreting the results and data.

In general, the three main outcome measures that have been assessed are recall, impact on subsequent reproductive behavior, and patient satisfaction. Most studies have shown that the majority of individuals who have attended a genetic counseling clinic have a reasonable recall of the information given, particularly if this was reinforced by a personal letter or follow-up visit. Nevertheless, confusion can arise, and as many as 30% of counselees have difficulty in remembering a precise risk figure. Studies that have focused on the subsequent reproductive behavior of couples that have attended a genetic counseling clinic have shown that approximately 50% have been influenced to some extent, particularly in relation to the severity of the disorder, the desire of parents to have children, and whether prenatal diagnosis and/or treatment are available. Finally, studies that have attempted to assess patient satisfaction have struggled to address the problem of how this should best be defined. For example, an individual could be very satisfied with

the way in which they were counseled but remain very dissatisfied by lack of a precise diagnosis or the availability of a definitive prenatal diagnostic test.

During times when there is little or no money for expansion of healthcare services, whether private or state funded, the 'value' and 'effectiveness' of genetics services, particularly genetic counseling, may be questioned. Health economics has often focused on the prevention of seriously disabling (and expensive) genetic diseases, but this always carries undertones of a eugenics philosophy. Patient autonomy has always been the guiding ethical principle for genetics healthcare professionals and there is now a very significant profile for rare diseases at a political level. As mentioned above, whole exome and whole genome sequencing is changing the landscape with respect to data interpretation, which in turn requires genetic counseling skills at the patient interface. The other development which may in some way have an impact on future genetic counseling practice is the rise of direct-to-consumer testing, whereby individuals choose to pay for a range of genetic tests without the involvement of genetics professionals. This may prove to be a significant component of 'personalized healthcare', which will lead to novel studies of outcome measures and patient satisfaction.

### Special Issues in Genetic Counseling

There are a number of special issues that can arise in genetic counseling.

#### Consanguinity

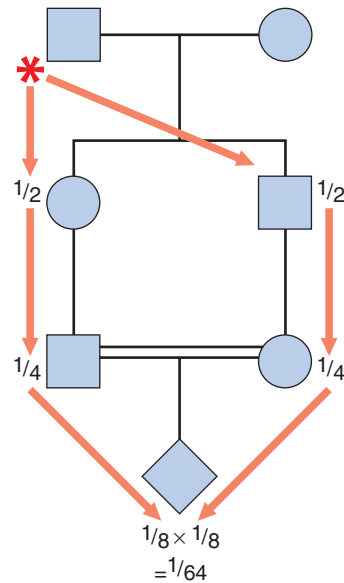
A consanguineous relationship is one between blood relatives who have at least one common ancestor no more remote than a great-great-grandparent. Consanguineous marriage is widespread in many parts of the world (Table 21.2). In Arab populations, the most common type of consanguineous marriage occurs between first cousins who are the children of two brothers, whereas in the Indian subcontinent uncle-niece marriages are the most commonly encountered form of consanguineous relationship. Although there is in these communities some recognition of the potential disadvantageous genetic effects of consanguinity, there is also a strongly held view that these are greatly outweighed by social advantages such as greater family support and marital stability.

Many studies have shown that among the offspring of consanguineous marriages, there is an increased incidence of

**Table 21.2** Worldwide Incidence of Consanguineous Marriage

Country	Incidence (%)
Kuwait	54
Saudi Arabia	54
Jordan	50
Pakistan	40–50
India	5–60
Syria	33
Egypt	28
Lebanon	25
Algeria	23
Japan	2–4
France, UK, USA	2

Data adapted from various sources including Jaber L, Halpern GJ, Shohat M 1998 The impact of consanguinity worldwide. *Commun Genet* 1: 12–17.



**FIGURE 21.3** Probability that the first child of first cousins will be homozygous for the deleterious allele (\*) carried by the common great-grandfather. A similar risk of 1 in 64 will apply to the deleterious allele belonging to the common great-grandmother, giving a total risk of 1 in 32.

both congenital malformations and other conditions that will present later, such as hearing loss and mental retardation. For the offspring of first cousins, the incidence of congenital malformations is increased to nearly twice that seen in the offspring of unrelated parents, attributed mainly to homozygosity for autosomal recessive disorders.

On the basis of studies of children born to consanguineous parents, it has been estimated that the average human carries no more than one harmful autosomal recessive disease gene. Most prospective consanguineous parents are concerned primarily with the risk that they will have a disabled child, and fortunately the overall risks are usually relatively small. When estimating a risk for a particular consanguineous relationship, it is generally assumed that each common ancestor carried one deleterious recessive mutation. Therefore, for first cousins, the probability that their first child will be homozygous for their common grandfather's deleterious gene will be 1 in 64 (Figure 21.3). Similarly, the risk that this child will be homozygous for the common grandmother's recessive gene will also be 1 in 64. This gives a total probability that the child will be homozygous for one of the grandparent's deleterious genes of 1 in 32. This risk should be added to the general population risk of 1 in 40 that any baby will have a major congenital abnormality (p. 215), to give an overall risk of approximately 1 in 20 that a child born to first-cousin parents will have a significant medical problem. Risks arising from consanguinity for more distant relatives are much lower, though in consanguinity there is also a slightly increased risk that a child will have a polygenic disorder. In practice this risk is usually very small. In contrast, a close family history of an autosomal recessive disorder can convey a relatively high risk that a consanguineous couple will have an affected child. For example, if the sibling of someone with an autosomal recessive disorder marries a first cousin, the risk that their first baby will be affected equals 1 in 24 (p. 97).

**Table 21.3** Genetic Relationship Between Relatives and Risk of Abnormality in Their Offspring

Genetic Relationship	Proportion of Shared Genes	Risk of Abnormality in Offspring (%)
<b>First Degree</b>	1/2	50
Parent-child		
Brother-sister		
<b>Second Degree</b>	1/4	5–10
Uncle-niece		
Aunt-nephew		
Double first cousins		
<b>Third Degree</b>	1/8	3–5
First cousins		

### Incest

Incestuous relationships are those that occur between first-degree relatives—in other words, brother-sister or parent-child (Table 21.3). Marriage between first-degree relatives is forbidden, both on religious grounds and by legislation, in almost every culture. Incestuous relationships are associated with a very high risk of abnormality in offspring, with less than half the children of such unions being entirely healthy (Table 21.4).

### Adoption and Genetic Disorders

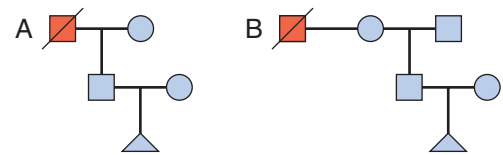
The issue of adoption can arise in several situations relating to genetics. First, parents at high risk of having a child with a serious abnormality sometimes express interest in adopting rather than running the risk of having an affected baby. In genetic terms, this is a perfectly reasonable option, although in practice the number of couples wishing to adopt usually far exceeds the number of babies and children available for adoption.

Secondly, geneticists are increasingly being asked to assess children who are available for placement, and these are frequently children whose parents have a history of learning disability and/or prenatal exposure to recreational drugs and alcohol. In some cases children are the offspring of an incestuous union, or there is a known family history of a hereditary disorder. This may raise the difficult ethical dilemma of predictive testing in childhood for late onset conditions (p. 326), though most believe that adoption is not a reason to make exceptions to the normal conventions.

Concern about the possible misuse of genetic testing in neonates and young children who are up for adoption prompted the American Society of Human Genetics and the American College of Medical Genetics to issue joint recommendations. These are based on the best interests of the child and can be summarized as supporting genetic testing only when it would

**Table 21.4** Frequency of the Three Main Types of Abnormality in the Children of Incestuous Relationships

Abnormality	Frequency (%)
<b>Intellectual Impairment</b>	
Severe	25
Mild	35
Autosomal recessive disorder	10–15
Congenital malformation	10



**FIGURE 21.4** Non-paternity identified in (A) through haplotype analysis (not shown) to provide a couple with a genetic ‘exclusion’ test for Huntington disease, from which the man’s father died. The relationships are in fact as shown in (B). Prenatal testing was therefore not indicated but it was necessary to explain the reason to the couple, which presented a significant counseling challenge.

be appropriate for any child of that age, for disorders that manifest during childhood, and for which preventive measures or screening is appropriate in childhood. The joint statement does not support testing for untreatable disorders of adult onset or for detecting predispositions to ‘physical, mental, or behavioral traits within the normal range’.

### Non-Paternity

Until the 1980s blood group studies were the mainstay of trying to contest paternity but the identity of the father could not be proved with certainty. If a child possessed a blood group not present in either the mother or putative father, then paternity could be confidently excluded. Similarly, if a child lacked a marker that the putative father would have had to transmit to all of his children, then paternity could be excluded, e.g., a putative father with blood group AB could not have a child with blood group O.

This has now been superseded by DNA fingerprinting, first conceived and developed by Alec Jeffreys in the 1980s, and is based on highly variable (or polymorphic) repeat sequences of DNA—variable number tandem repeats, particularly short tandem repeats. In fact, establishing paternity in court cases seldom involves clinical geneticists or genetic counselors. However, very difficult situations may arise when routine genetic testing, mainly using polymorphic markers and haplotype patterns, unexpectedly uncovers non-paternity. Where this has no medical consequences genetic counselors will usually not disclose the full results as the impact on family relationships may be devastating. However, take for example a couple who request Huntington Disease (HD) exclusion testing for a pregnancy (Figure 21.4). The man believes he is at 50% risk of developing HD because his deceased father was affected (Figure 21.4A), and he does not want to undergo predictive testing for himself. Exclusion testing uses polymorphic markers to establish a haplotype pattern, in order to exclude whether the pregnancy is at 50% risk of having inherited HD. The analysis shows that the man was not fathered by the deceased individual with HD (Figure 21.4B), and is therefore extremely unlikely to be at risk of HD himself. In this case the results need to be sensitively disclosed because prenatal testing is no longer indicated, and this requires very careful approaches with good counseling skills.

### FURTHER READING

ASHG/ACMG: Statement, 2000. Genetic testing in adoption. *Am. J. Hum. Genet.* 66, 761–767.

*The joint recommendations of the American Society of Human Genetics and the American College of Medical Genetics on genetic testing in young children who are being placed for adoption.*

Clarke, A. (Ed.), 1994. Genetic counselling. Practice and principles. Routledge, London.

*A thoughtful and provocative multi-author text that addresses difficult issues such as predictive testing, screening, prenatal diagnosis, and confidentiality.*

Clarke, A., Parsons, E., Williams, A., 1996. Outcomes and process in genetic counseling. Clin. Genet. 50, 462–469.

*A critical review of previous studies of the outcomes of genetic counseling.*

Frets, P.G., Niermeijer, M.F., 1990. Reproductive planning after genetic counselling: a perspective from the last decade. Clin. Genet. 38, 295–306.

*A review of studies undertaken between 1980 and 1989 to determine which factors are most important in influencing reproductive decisions.*

Harper, P.S., 1998. Practical genetic counseling, fifth ed. Butterworth-Heinemann, Oxford.

*An extremely useful practical guide to all aspects of genetic counseling.*

Jaber, L., Halpern, G.J., Shohat, M., 1998. The impact of consanguinity worldwide. Community Genet. 1, 12–17.

*A review of the incidence and consequences of consanguinity in various parts of the world.*

Jeffreys, A.J., Brookfield, J.F.Y., Semeonoff, R., 1985. Positive identification of an immigration test-case using human DNA fingerprints. Nature 317, 818–819.

*A clever demonstration of the value of genetic fingerprinting in analyzing alleged family relationships.*

Turnpenny, P., 2014. Parenting a child with, or at risk of, genetic disorders. British Agencies for Adoption and Fostering, London.

*A basic text targeting a lay readership, particularly those involved with, or affected by, adoption.*

## ELEMENTS

- 1 Genetic counseling may be defined as a communication process that deals with the risk of developing or transmitting a genetic disorder.
- 2 The most important steps in genetic counseling are the establishment of a diagnosis, estimation of a recurrence risk, communication of relevant information, and provision of appropriate support.
- 3 The pertinent counseling theory is person-centered, non-directive, and non-judgmental. The goal of genetic counseling is to provide accurate information that enables counselees to make their own fully informed decisions.
- 4 Marriage between blood relatives conveys an increased risk for an autosomal recessive disorder in future offspring. The probability that first cousins will have a child with an autosomal recessive condition is approximately 3%, although this risk can be greater if there is a family history of a specific genetic disorder.
- 5 Some situations pose very significant genetic counseling challenges, particularly if the information is complex and unexpected disclosures become necessary, e.g., in cases of non-paternity discovered through routine genetic analysis. Other situations demanding skilled counseling include cross-cultural communication, severe emotional stress in the family, and when facing pressure to perform predictive tests inappropriately.

# Ethical and Legal Issues in Medical Genetics

Ethics is the branch of knowledge that deals with moral principles, which in turn relate to principles of right, wrong, justice, and standards of behavior. Traditionally, the reference points are based on a synthesis of the philosophical and religious views of well-informed, respected, thinking members of society. In this way, a code of practice evolves that is seen as reasonable and acceptable by a majority, which often forms the basis for professional guidelines or regulations. It might be argued that there are no ‘absolutes’ in ethical and moral debates. In complex scenarios, in which there may be competing and conflicting claims to an ethical principle, practical decisions and actions often have to be based on a balancing of duties, responsibilities, and rights. Ethics, like science, is not static but moves on, and in fact the development of the two disciplines is closely intertwined.

Ethical issues arise in all branches of medicine, but human genetics poses particular challenges because genetic identity impinges not just on an individual, but also on close relatives and the extended family, and beyond kindreds to society in general. In the minds of the general public, clinical genetics and genetic counseling can easily be confused with eugenics—which may be defined as the science of ‘improving’ a species through breeding, or ‘improving the gene pool’. Crucially, modern clinical genetics bears no relationship with the appalling eugenic philosophies practiced in Nazi Germany and, to a much lesser extent, elsewhere in Europe and the United States between the two world wars. Eugenics was very fashionable for a period. The term was coined by Francis Galton in 1883, a year after Charles Darwin’s death, to whom Galton was related as a half-cousin. Three International Congresses of Eugenics took place between 1912 and 1932, the first in London, and the great and good of the day in science, politics and social planning attended. In the USA a Eugenics Records Office was established in 1910 with funding from the Carnegie Institution, and conducted research until discredited in the mid-1930s. The site eventually became the Cold Spring Harbor Laboratory in 1962.

Emphasis has already been placed on the fundamental principle that genetic counseling is a *non-directive* and *non-judgmental* communication process whereby factual knowledge is imparted to facilitate informed personal choice (see [Chapter 21](#)). Indeed, clinical geneticists have been pioneers in practicing and promoting non-paternalism in medicine, and 5% of the original budget for the Human Genome Project was set aside for funding studies into the ethical, legal, and social implications of the knowledge gained from the project. This was in recognition of the challenges generated by discoveries and new technologies in molecular genetics. Keen awareness and debate continues, as reflected in the controversy surrounding policies and practice in disclosing ‘incidental findings’ from whole exome or whole genome sequencing. As these technologies enter medicine’s mainstream there is a need for guidelines and

*The mere existence of the complete reference map and DNA sequence down to the last nucleotide may lead to the absurdity of reductionism—the misconception that we know everything it means to be human; or to the absurdity of determinism—that what we are is a direct and inevitable consequence of what our genome is.*

VICTOR MCKUSICK (1991)

some protections enshrined in law, and clinical geneticists will often be well placed to offer advice. Here we explore some of the controversial and difficult areas, though often there is no clear right or wrong approach, and individual views vary widely. Sometimes in a clinical setting the best that can be hoped for is to arrive at a mutually acceptable compromise, with an explicit agreement that opposing views are respected and, personal conscience permitting, patient needs are met, or at least fully addressed.

## General Principles

The time-honored four principles of medical ethics that command wide consensus are listed in [Box 22.1](#). Developed and championed by the American ethicists Tom Beauchamp and James Childress, these principles provide an acceptable framework, although close scrutiny of many difficult dilemmas highlights limitations in these principles and apparent conflicts between them. Everyone involved in clinical genetics will sooner or later be confronted by complex and challenging ethical situations, some of which pose particularly difficult problems with no obvious solution, and certainly no perfect one. Just as patients need to balance risks when making a decision about a treatment option, so the clinician/counselor may need to balance these principles one against the other. A particular difficulty in medical genetics can be the principle of

### Box 22.1 Fundamental Ethical Principles

- **Autonomy**—incorporating respect for the individual, privacy, the importance of informed consent, and confidentiality
- **Beneficence**—the principle of seeking to do good and therefore acting in the best interests of the patient
- **Non-maleficence**—the principle of seeking, overall, not to harm (i.e., not to leave the patient in a worse condition than before treatment)
- **Justice**—incorporating fairness for the patient in the context of the resources available, equity of access, and opportunity

### Box 22.2 The Jonsen Framework: A Practical Approach to Clinical Ethics

Indications for medical intervention—Establish a diagnosis.  
Determine the options for treatment and the prognoses for each of the options.

- Preferences of patient—Is the patient competent? If so, what does he or she want? If not competent, what is in the patient's best interest?
- Quality of life—Will the proposed treatment improve the patient's quality of life?

Contextual features—Do religious, cultural, or legal factors have an impact on the decision?

*autonomy*, given that genes are shared with biological relatives. Individual autonomy needs sometimes to be weighed against the principle of doing good and doing no harm, to close family members.

The **Beauchamp and Childress framework** of ethical principles is, unsurprisingly, not the only one in use and others have developed them into practical approaches. These include the Jonsen framework (Box 22.2) and the more detailed scheme developed by Mike Parker of Oxford's Ethox Centre (Box 22.3), which builds on previous proposals. Taken together, these provide a practical approach to clinical ethics, which is an expanding discipline in health care.

In practice, the issues that commonly arise in the genetics clinic during any patient contact are outlined below.

#### Autonomy

It is the patient who should be empowered and in charge when it comes to decisions that have to be made. The degree to which this is possible is a function of the quality of information given. Sometimes patients are still seeking some form of guidance to give them confidence in the decision they reach, and it will require the judgment of the clinician/counselor as to how much guidance is appropriate in a given situation. The patient should feel comfortable to proceed no further, and opt out freely at any stage of the process; this applies particularly in the context of predictive genetic testing and reproductive decisions.

#### Informed Choice

The patient is entitled to full information about all options available in a given situation, including the option of not participating. Potential consequences of each decision option should be discussed. No duress should be applied and the clinician/counselor should not have a vested interest in the patient pursuing any particular course of action.

#### Informed Consent

A patient is entitled to an honest and full explanation before any procedure or test is undertaken. Information should include details of the risks, limitations, implications, and possible outcomes of each intervention. In the current climate, with respect to full information and the doctor-patient contract, some form of *signed* consent is increasingly being obtained for every action that exposes the patient—access to medical records, clinical photography, genetic testing, and storage of DNA. In fact, there is no legal requirement to obtain signed consent for taking a blood test from which DNA is extracted and stored. The issue was addressed by the UK Human Tissue

Act 2004. According to the act, DNA does not constitute 'human tissue' in the same way as biopsy samples or cellular material, for which formal consent is required, whether the tissue is from the living or the dead. The act does require that consent is formally obtained where cellular material is used to obtain genetic information *for another person*. In a clinical setting, this must be clearly discussed and documented.

In clinical genetics, many patients who are candidates for clinical examination and genetic testing are children or adults with learning difficulties who may lack capacity to grant informed consent. Furthermore, the result of any examination or test may have only a small chance of directly benefiting the patient but is potentially very important for family members. Here the law is important. In England and Wales, the Mental Capacity Act of 2005 came into effect in 2007 and applies to adults aged 16 and older. It replaced case law for health (and social) care and there is a legal duty to use the legislation and apply the 'Test for Capacity' (Box 22.4) for any relevant decision for people who lack capacity. Decisions must take into account the 'best interests' of the patient, but can also embrace the wider interests that relate to the family. In England and Wales, the law allows for an appropriate person appointed by the Court of Protection to act on their behalf, whereas in

### Box 22.3 The Ethox Centre Clinical Ethics Framework (Mike Parker)

1. What are the relevant clinical and other facts (e.g., family dynamics, general practitioner support)?
2. What would constitute an appropriate decision-making process?
  - Who is to be held responsible?
  - When does the decision have to be made?
  - Who should be involved?
  - What are the procedural rules (e.g., confidentiality)?
3. List the available options.
4. What are the morally significant features of each option; for example:
  - What does the patient want to happen?
  - Is the patient competent?
  - If the patient is not competent, what is in his or her 'best interests'?
  - What are the foreseeable consequences of each option?
5. What does the law/guidance say about each of these options?
6. For each realistic option, identify the moral arguments in favor and against.
7. Choose an option based on judgment of the relative merits of these arguments:
  - How does this case compare with others?
  - Are there any key terms for which the meaning needs to be agreed (e.g., 'best interest', 'person')?
  - Are the arguments 'valid'?
  - Consider the foreseeable consequences (local and more broad).
  - Do the options 'respect persons'?
  - What would be the implications of this decision applied as a general rule?
8. Identify the strongest counterargument to the option you have chosen.
9. Can you rebut this argument? What are your reasons?
10. Make a decision.
11. Review this decision in the light of what actually happens, and learn from it.

### Box 22.4 Mental Capacity Act, 2005, England and Wales (Outline)—Principles, Definition, and Test for Capacity

#### Principles:

- A person must be assumed to have capacity unless proved otherwise
- A decision taken for someone lacking capacity must be in the person's best interests
- Practical steps must be taken to help someone make a decision
- If the test of capacity is passed the decision taken must be respected

#### Definition of Capacity:

'... a person lacks capacity in relation to a matter if at the material time he is unable to make a decision for himself in relation to the matter because of an impairment of, or a disturbance in the functioning of, the mind or brain.'

- In relation to any decision, it is therefore:
  - Time specific (a person's capacity may change)
  - Decision specific (capacity varies, depending on the decision)

#### Test for Capacity:

At a specific time and for a specific decision, the person should:

- Understand the information relevant to the decision
- Retain the information
- Weigh the information as part of decision making
- Communicate the decision

Scotland it is legally permitted for certain designated adults, including family members, to give consent (or refuse) on behalf of a person lacking capacity.

### Confidentiality

A patient has a right to complete confidentiality, and there are clearly many issues relating to genetic disease that a patient, or a couple, would wish to keep totally private. Stigmatization and guilt may still accompany the concept of hereditary illness. Traditionally, confidentiality should be breached only under extreme circumstances; for example, when it is deemed that an individual's behavior could convey a high risk of harm to self or to others. In trying to help some patients in the genetics clinic, however, it may be desirable to have a sample of DNA from a key family member, necessitating at least some disclosure of detail. There is also the difficult area of sharing information and results between different regional genetic services. This is a complex and much debated area in the context of genetic and hereditary disease but the principle of patient consent for release and/or sharing of information should be the norm.

### Universality

Much of traditional medical ethical thinking has upheld the autonomy of the *individual* as paramount. Growing appreciation of the ethical challenges posed by genetics has led to calls for a new pragmatism in bioethics, built on the concept that the human genome is fundamentally common to all humankind, and can—and indeed should—be considered a shared resource because we have a shared identity at this level. What we learn from one individual's genome, from a family's genome, or a population's genome, carries potential benefits far beyond the immediate relevance and impact for that individual or family.

From this it is a direct and natural step to consider how best the genetic information is exchanged, for the medical benefits may be far reaching. This ethical *attitude* therefore leads on to a realization of mutual respect, reciprocity, and world citizenry in the context of human genetics. It prompts the individual to consider his or her responsibility toward others, as well as to society, both in the present and in the future.

Meanwhile, however, very real ethical problems have to be faced and dealt with in some way, and it is to a few of these that we now turn.

## Ethical Dilemmas in the Genetics Clinic

### Prenatal Diagnosis

Many methods are now widely available for diagnosing structural abnormalities and genetic disorders during the first and second trimesters (see Chapter 20). The past 40 years or so have seen the first real availability of *choice* in the context of pregnancy in human history. Not surprisingly, the issue of prenatal diagnosis and subsequent offer of termination of pregnancy raises many difficult issues for those directly involved, and raises serious questions about the way in which society views and cares for both children and adults with disability. In the United Kingdom, termination of pregnancy is permitted up to and beyond 24 weeks' gestation if the fetus has a lethal condition such as anencephaly, or if there is a serious risk of major physical or mental disability. For good reason, terms such as 'serious' are not defined in the relevant legislation, but this can inevitably lead to controversy over interpretation.

The difficulties surrounding prenatal diagnosis can be illustrated by considering some of the general principles that have already been discussed. At the top of the list comes informed consent. In the United Kingdom, all pregnant women are offered maternal serum screening for Down syndrome in the first trimester, combined with estimation of nuchal translucency by ultrasound at 12 weeks' gestation (p. 303). In addition, a 20-week fetal anomaly scan is routine and has replaced the 16-week assay of maternal serum  $\alpha$ -fetoprotein to look for neural tube defects. For fully informed consent to be obtained in these situations, it is essential that pregnant women have access to detailed counseling by unhurried professionals who are knowledgeable, experienced, and sympathetic. In practice this may not always be so and the quality of information can vary widely.

The most difficult problems in prenatal diagnosis are those involving autonomy and individual choice relating to disease severity and the decision that termination is justified. Consider the following. Firstly, parents whose first child, a boy, has autism, are expecting another baby. They have read that autism is more common in boys than girls, so they request sexing of the fetus with a view to terminating a male but continuing if female. However, the risk of having another child with autism is roughly 5%. Such a request presents the clinician and counselor with a challenge. Sex selection for purely social reasons is illegal in the UK as grounds for termination of pregnancy as well as embryo selection by preimplantation genetic diagnosis (supported overwhelmingly by a public consultation exercise)—children should be considered as gifts, not consumer commodities. In the United States and elsewhere, however, it is permissible to perform sex selection by preimplantation genetic diagnosis (PGD) for 'family balancing'. But when the risk of a second child having autism is low, and it cannot be

guaranteed that a daughter would not be affected, clinicians would generally resist sex selection and termination. Secondly, consider the unusual request of parents with congenital deafness who indicate they wish to continue a pregnancy *only* if tests show that their unborn baby *is also affected*. Should the autonomy and choice of the couple, who live in a non-hearing world, be respected? Again, most clinicians would decline the request but the scenario challenges perceptions and definitions of what it means to be normal. Thirdly, when a fetus is found to have cleft lip and palate, for which surgical correction usually achieves an excellent outcome, if one of the parents themselves had an unhappy childhood because of stigmatization for the same problem, they may wish to exercise choice.

The subject of pregnancy termination frequently generates controversy. Proponents of choice argue that selective termination should be available, particularly if the alternative involves a lifetime of pain and suffering. But prenatal tests often provide reassurance, and without the availability of diagnostic techniques couples might decide against trying to have (further) children at all. In the context of abortion in general, termination on grounds of fetal abnormality constitutes less than 2% of the total of nearly 200,000 abortions carried out each year in the UK.

Those who hold opposing views argue on religious, moral, or ethical grounds that selective termination is little less than legalized infanticide. Key to the ethical issue here are views on the status and rights of the embryo and fetus. For those who believe that the fertilized egg constitutes full human status, PGD and embryo research are unacceptable, as well as most in vitro fertilization (IVF) as practiced by virtue of generating spare frozen human embryos, most never to be used. There is also concern that prenatal diagnostic screening programs could lead to a devaluing of the 'disabled' and 'abnormal' in society (notwithstanding that these terms are difficult to define and all too often used pejoratively), with a possible shift of resources away from their care to the funding of programs aimed at 'preventing' their birth. This ethical debate is being fueled anew as microarray-CGH technology moves into prenatal testing, and in the future possibly whole exome or whole genome sequencing. It is quite conceivable that a large range of tests will be technically possible on free-fetal DNA in the maternal circulation—without the risk of provoking a miscarriage from an invasive procedure. How will these new genetic technologies affect the scope of prenatal screening tests that may be offered, and who will decide? And will anyone be so bold as to offer selection for 'desirable characteristics', e.g. hair color, musical ability, athleticism?

The results of public consultation exercises conducted by the Advisory Committee on Genetic Testing (subsumed into the Human Genetics Commission—abolished in 2010) and the Human Fertilization and Embryology Act are reasonably reassuring. The views expressed support the applications of genetic technologies in prenatal testing for *serious* disorders but demonstrate concern over wider applications. Similarly, research published by the British Social Attitudes survey suggested that the public supports these activities in general but expressed deep reservations for application of the technologies for **genetic enhancement**. Enhancement of embryos or gametes strikes at the very heart of what it means to have one's own genetic identity through laws of chance. This seems to be a powerful undercurrent in the understanding of who we are as individuals and as a species but has been tested in the area of 'mitochondrial donation' through nuclear transfer to prevent serious

life-shortening mitochondrial disease. After much parliamentary debate this became legal in the UK in 2015, with opponents and the media inappropriately branding the development 'three-parent babies'.

### Predictive Testing in Childhood

Understandably, parents sometimes wish to know whether or not a child has inherited the gene for an adult-onset autosomal dominant disorder that runs in the family. It could be argued that this knowledge will help them guide their child toward the most appropriate support through education, and that to refuse their request is a denial of their rights as parents. Similarly, parents may request testing to clarify the status of young healthy children at risk of being carriers of a recessive disorder such as cystic fibrosis (sometimes this information will have become available as a result of prenatal diagnostic testing).

The problem with agreeing to such a request is that it infringes the child's own future autonomy, so most geneticists recommend that testing be delayed until the child reaches an age at which an informed decision is possible. There is also concern for the child about the possible psychological harm of growing up with certain knowledge of developing a serious adult-onset hereditary disorder, or being a carrier of a recessive disorder, particularly if the tests have proved negative in the child's siblings. However, although there is consensus among geneticists that children should not be tested for *carrier* status, the evidence that such testing causes emotional or psychological harm is weak. The situation is of course very different if predictive testing could directly benefit the child by identifying the need for a medical or surgical intervention *in childhood*. This applies to conditions such as familial hypercholesterolemia (p. 140) and some of the familial cancer-predisposing syndromes (p. 189). Generally, in these situations genetic testing is recommended around the time when other screening tests or preventive measures would be initiated.

One of the arguments for not testing children for adult-onset disorders is that parents might view their child differently, or even prejudicially. This type of argument has been voiced in relation to the PGD cases that have selected embryos not only for their negative affection status for Fanconi anemia but also in order to be a potential stem-cell donor for an affected child—so-called 'savior siblings', first successful in the USA in 2000. Those objecting to this use of technology cite a *utilitarian*, or *instrumental*, attitude toward the child created in this way. Furthermore, the child so created has no choice about whether to be a tissue-matched donor for the sick sibling. Will the child eventually feel 'used' by the parents and how might he or she feel if the treatment fails and the sick sibling dies? At present these questions are imponderables because most children created for this purpose are still young.

### Implications for the Immediate Family (Inadvertent Testing or Testing by 'Proxy')

A positive test result in an individual can have major implications for close antecedent relatives who themselves may not wish to be informed of their disease status. Consider Huntington disease for example. A young man age 20 requests predictive testing before starting his family, knowing that his 65-year-old paternal *grandfather* has a confirmed diagnosis. Predictive testing would be relatively straightforward were it not for the fact that his father, who is obviously at a prior risk of 1 in 2, specifically does not wish to know whether he will develop the disease. Thus, the young man has raised the



difficult question of how to honor his request without inadvertently carrying out a predictive test on his father. A negative result in the young man leaves the situation unchanged for his father, but a positive result might be difficult to conceal from an observant father. The son knows that his father will develop the disease if he has not done so already.

Whilst this can be a difficult scenario, guidelines drawn up in 1994 concluded that 'every effort should be made by the counselors and the persons concerned to come to a satisfactory solution'. Most geneticists follow the rider that, 'if no consensus can be reached the right of the adult child to know should have priority over the right of the parent not to know'.

### Implications for the Extended Family

It is generally agreed that the diagnosis of a condition that could have implications for other family members should lead to the offer of tests for the extended family, e.g. balanced translocations and serious X-linked recessive disorders.

The main ethical problem that may arise here is one of confidentiality. A carrier of a translocation or serious X-linked recessive disorder is usually urged to alert close family relatives to the possibility that they could also be carriers and therefore at risk of having affected children. Alternatively, permission can be sought for members of the genetics team to make these approaches. Occasionally a patient, for whatever reason, will refuse to allow this information to be disseminated.

Faced with this situation, what should the clinical geneticist do? In practice most would try to convince their patient of the importance of offering information and tests to relatives by providing an explanation of the consequences and future ill-feeling that could ensue if a relative was to have an affected child whose birth could have been avoided. In most cases, skilled and sensitive counseling will lead to a satisfactory solution. Ultimately, however, some clinical geneticists would opt to respect their patient's confidentiality rather than break the trust that forms a cornerstone of the traditional doctor-patient relationship. Not all would agree, and therefore some clinicians will actively seek a sensitive way to disclose the medical/genetic information. This view is backed up by the statements of authoritative working parties, such as the Nuffield Council on Bioethics. Sometimes it is possible to involve the general practitioner of the family member at risk, who might be well placed to open up the issue.

### Informed Consent in Genetic Research

Any offer of genetic testing should be accompanied by a full and clear explanation of what the test involves and how the results could have implications for the individual and family members. This applies equally to informed consent when participating in genetic research. Many people are perfectly willing to hold out their arm for a blood test which might 'help others', particularly if they have personal experience of a serious disorder in their own family. However, their simple act of altruism may have unforeseen consequences. For example, it is unlikely that they will ever have considered whether their sample will be tested anonymously, who will be informed of the result, or whether other tests will be carried out on stored DNA in the future as new techniques are developed. The issues listed in [Box 22.5](#) help to emphasize that all aspects of informed consent should be addressed when samples are collected for genetic research. Just as signed consent for genetic testing and storage of DNA has become routine in the service setting in the UK (although not a legal requirement under the Human

### Box 22.5 Issues of Disclosure and Consent in Genetic Research—The Nature of the Study

- Who is doing the study and where is it being carried out?
- Availability of results and their implications for the individual and extended family regarding health, employment, and insurance
- Anonymity of testing and confidentiality of results
- Long-term storage of DNA and its possible use in other research projects
- Potential commercial applications and profit

Tissue Act 2004), similar rigor should be adhered to in a research setting.

### Secondary, or Incidental, Findings

The advent of whole exome and whole genome sequencing in research, and increasingly in service testing, has brought to the fore a debate regarding the handling and disclosure of so-called 'secondary', or 'incidental', findings, i.e. the discovery of pathogenic variants in genes—e.g., for a highly penetrant Mendelian cancer condition—that have nothing to do with the primary reason for undertaking next generation sequencing. This should not be a problem where the analysis is restricted to genes of interest that are relevant to the phenotype, but may occur where there is no such restriction, and the issue is of particular concern for conditions where a presymptomatic medical or surgical intervention, or screening modality, would normally be offered. The potential dilemma is whether or not such findings should be disclosed to the patients being tested, or only disclosed if the findings are interpretable as pathogenic. Ideally, the consent process prior to testing should accommodate the patient's wishes, including whether such conditions should be included in the analysis. However, to what extent can most people understand the implications for a broad range of possible diseases? How much time can realistically be devoted to counseling in this consent process, and do the complexities of the medical and genetic issues fundamentally undermine the very concept, and therefore legality, of 'fully informed consent'? To this can be added the evolution of knowledge that will inevitably take place regarding the significance of certain findings as well as the range of conditions for which a presymptomatic intervention becomes available, which has led to a separate debate regarding the professionals' responsibilities to recontact patients when new information comes to light.

The American College of Genetics and Genomics recently issued a policy on secondary findings and settled on 56 genes that met the criteria for disclosure, if tested. The key points of the policy are summarized in [Box 22.6](#).

### Ethical Dilemmas and the Public Interest

Advances in genetics attract great media interest and this has brought the ethical debate to a wide public arena. Topics such as insurance, forensic science and DNA databases, patenting, gene therapy, population screening, cloning, stem-cell research, and hybrids, are seen as being of major societal, commercial, and political importance, and therefore impact clinical and laboratory practice in medical genetics.

### Box 22.6 Key Points of the Policy of the American College of Genetics and Genomics Regarding Secondary (Incidental) Findings

- When clinical genome-scale sequencing is performed, written informed consent should be obtained by a qualified genetics healthcare professional regarding all aspects of the nature of the test, including the routine analysis of a set of genes deemed to be highly medically actionable.
- Patients may opt out of the analysis of this set of genes but should be made aware of the potential ramifications of doing so.
- The same policy should apply to children as well as adults, with parents being able to opt out of the analysis.
- It is not feasible for patients to be offered the option of choosing a subset of medically actionable genes for analysis and the decision regarding routine analysis should apply to the entire set of genes deemed actionable by the American College of Medical Genetics and Genomics.

## Genetics and Insurance

Predictive genetic testing for adult onset disorders that may give rise to chronic ill health and/or reduced life expectancy has led to concern about the extent to which the results of tests should be revealed to outside agencies, especially insurance companies providing life cover, private health care, and critical illness and disability income. Insurance arranged through an employer might, in theory, compromise career prospects.

The life insurance industry is competitive and profit driven. Private insurance is based on 'mutuality', whereby risks are pooled for individuals in similar circumstances. In contrast, public health services are based on the principle of 'solidarity', whereby health provision for everyone is funded from general taxation. It is understandable that the life insurance industry is concerned that individuals who receive a positive predictive test result will take out large policies without revealing their true risk status. On the other hand, the genetics community is concerned that individuals who test positive will become victims of discrimination, and perhaps uninsurable. This concern extends to those with a family history of a late-onset disorder, who might be refused insurance unless they undergo predictive testing.

The possibility that DNA testing will create an uninsurable 'genetic underclass' led to the introduction of legislation in parts of the United States aimed at limiting the use of genetic information by health insurers. In 1996 this culminated in President Clinton signing The Health Insurance Portability and Accountability Act, which expressly prevented employer-based health plans from refusing coverage on genetic grounds when a person changes employment. In the United Kingdom, this whole arena was considered in 1995 by the House of Commons Science and Technology Committee, which recommended that a Human Genetics Advisory Commission be established to overview developments in human genetics. In 1997 this Advisory Commission recommended that applicants for life insurance should not have to disclose the results of any genetic test to a prospective insurer and that a moratorium on disclosure of results should last for at least 2 years until genetic testing had been carefully evaluated.

Fortunately, the Association of British Insurers has negotiated amicably over the years and the moratorium has been

renewed several times, most recently in 2014, and is in place until November 2019. The essential aspects of the agreement, in the joint document entitled 'Concordat and Moratorium on Genetics and Insurance', are listed in [Box 22.7](#).

These issues are likely to come under repeated scrutiny in the future. Clinical genome sequencing is now a reality and there are many direct-to-consumer offers to discover one's genetic susceptibilities upon payment of a fee and production of a suitable saliva sample. Consequently, a large amount of individual genome data is being stored in the commercially driven private sector. The medical genetics community therefore has an advocacy role to ensure that the genetically disadvantaged, through no fault of their own, do not face discrimination when seeking health care or long-term life insurance, which are powerful arguments in favor of publicly funded healthcare systems.

## Forensic Science and DNA Databases

Similar themes relating to personal privacy apply to the existence of the police-controlled **National DNA Database**. The use of DNA fingerprinting in criminal investigations, to the tune of approximately 25,000 cases per annum, is now so sophisticated that there is a natural desire on the part of law enforcers to be able to identify the DNA fingerprint for anyone

### Box 22.7 Key Points in the 'Concordat and Moratorium on Genetics and Insurance' Negotiated Between the UK Government and the Association of British Insurers (ABI), 2014

- Applicants must not be asked to undergo predictive genetic testing.
- The classes of insurance for which genetic test results may apply:
  1. Life insurance policies up to £500,000
  2. Critical illness insurance up to £300,000
  3. Income protection insurance up to £30,000 per annum
- This agreement applies to predictive genetic test for conditions that are:
  1. Monogenic
  2. Late-onset
  3. High penetrance
- There is no requirement for a customer to reveal:
  1. A predictive genetic test result from a test taken after the insurance cover has started, for as long as that cover is in force
  2. The test result of another person, such as a blood relative
  3. A predictive or diagnostic test result acquired as part of clinical research
- Disclosure of a predictive genetic test result is only required if all of the following apply:
  1. The customer is seeking insurance cover above the financial limits set out in the Moratorium
  2. The test has been assessed by a panel of experts and approved by Government; to date, the only test that people are required to disclose under the agreement is for Huntington disease for life insurance where the insured sum is over £500,000
  3. The insurer asks the customer to disclose the information.
- An applicant may disclose a positive result from a predictive genetic test if they wish the result to be considered in the underwriting decision.

in the general population. Currently, nearly 6 million samples are stored, though one in seven of these are estimated to be duplicates, but that is still approaching 10% of the population (including an estimated 1 million with no criminal conviction), which is the largest of any country. For certain types of crime, whole communities are invited to come forward to give a sample of DNA so that they can be eliminated from enquiries. In 2009 the police came under political pressure to scrap 'innocent' profiles after the European Court of Human Rights declared that to hold the profiles of innocents indefinitely was a breach of privacy. This led to the removal of nearly 2 million profiles of innocent individuals, including children, in 2012–2013 under the Protection of Freedoms Act 2012.

The National DNA Database is huge but so too are the collections for big population studies, such as the Avon Longitudinal Study of Parents and Children, UK Biobank, or UK10K projects. As research, these samples will have been rigorously consented, but it is essential for safeguards to be in place.

### Gene Patenting and the Human Genome Project

Naturally occurring human DNA sequences have been the subject of some bitter and prolonged legal disputes over patenting, encapsulating the conflict between commercial goals and altruistic academia. During the 1990s Myriad Genetics in the USA sought to impose their exclusive license for genetic testing for *BRCA1* and *BRCA2* (p. 193). In fact, in 2004 the European Patent Office revoked the patent, denying Myriad a license fee from every *BRCA* test undertaken in Europe, and thereby setting a precedent for other contentious cases. However, the rights to one gene associated with obesity were sold in 1995 for \$70 million, and in 1997 DeCODE, the Icelandic genomics company at the center of the controversy regarding national assent, sold the potential rights to 12 genes associated with common complex diseases to Hoffman–La Roche for \$200 million. Logically, commercial developments using human DNA sequences are based on 'discovery' rather than 'invention', whereas the engineering of a new sequencing platform would fall into the latter category. It is clearly acceptable for biotechnology companies that have invested heavily in molecular research to recover their costs and make a fair return, but our genome represents humankind's 'common heritage' and the case is overwhelmingly persuasive that the information gained through the Human Genome and Human Variome Projects should be freely available for all to benefit. To this end an 'International Charter' for sharing bio-specimens and data has recently been proposed. There are examples, however, of patients and whole communities who have donated their blood samples for research little realizing that their generosity could be exploited for financial gain, resulting in some high-profile court cases, particularly in the USA. The legal issues can be complex, especially in an international context, but we believe strongly in promoting equity of access, transparency and scientific rigor towards the goal of evidence-based medicine available to as many as possible.

### Gene Therapy

The prospect of successful gene therapy (p. 204) to treat genetic disease is one of the most exciting developments of the modern era. However, apart from a handful of notable examples the potential has not yet been realized. As the furor over genetically modified foods has shown, the general public is seriously concerned about the safety and potential abuse of

gene therapy. The 'slippery slope' argument is frequently invoked, whereby to take the first step leads incrementally and inevitably to uncontrolled experimentation. The strongest advocates of new approaches, understandably, are the families affected by extremely unpleasant conditions, but their yearning for solutions should rightly be set into a societal context and special advisory committees and working parties were set up in response. In the UK the Gene Therapy Advisory Committee (GTAC) was established in 1993 to review all proposals to conduct gene therapy in humans and to monitor ongoing trials, thus safeguarding patients' rights and confidentiality. Significantly, the GTAC recommended that genetic modification involving the germline be prohibited, and limited to somatic cells to prevent the possibility of newly modified genes being transmitted to future generations. Furthermore, modification of somatic cells should be restricted to the treatment of serious diseases, and not to alter human characteristics, such as intelligence or athletic prowess, for example. In 2011 the work of the GTAC was subsumed into the Health Research Authority.

### Newborn and Population Screening

Newborn screening programs offering detection of common autosomal recessive disorders have been available for many years (p. 149) and in some countries the range of diseases tested has been greatly extended in recent years. These programs have generally been very well received (e.g., thalassemia and Tay-Sachs disease), though this was not the case for  $\alpha 1$  antitrypsin deficiency screening in Scandinavia, which was abandoned because it proved stressful. Similarly, pilot studies to diagnose Duchenne muscular dystrophy soon after birth—essentially to inform and prevent the birth of a second affected son before a diagnosis is made in the first—have not resulted in widespread implementation of a population screening program.

As mentioned above, the advent of clinical exome sequencing raises fresh ethical concerns about how the technology might be applied. This is particularly so in the field of prenatal genetics and screening. Analysis of DNA from chorionic villus tissue, for example, could theoretically be subjected to whole exome sequencing in conjunction with parental samples quite apart from a condition for which the fetus is at high risk. Whilst there is little interest in this at present, and the costs would be prohibitive for a public screening program, when the price of testing decreases there may be strong pressure to offer this choice in some form.

With respect to screening programs that detect *carrier* status for disease, the issues are slightly different. Early efforts to introduce sickle-cell carrier detection in North America were largely unsuccessful because of misinformation, discrimination, and stigmatization. Also, pilot studies assessing the responses to cystic fibrosis (CF) carrier screening in white populations yielded conflicting results (p. 151). These experiences illustrate the importance of informed consent and the difficulties of ensuring both autonomy and informed choice. Neonatal CF screening in the UK is aimed at identifying babies with CF, but the screening detects a roughly equal number who are simply carriers, who have obviously not made an informed choice. This is considered justifiable when weighed against the benefits of early diagnosis of CF. In general, however, well-intended programs of carrier detection should ensure that participation is entirely voluntary with adequate counselling, and it is also essential to minimize the risk of conferring any

sense of stigmatization or genetic inferiority. Furthermore, confidentiality is important. This may be difficult, however, for individuals found to be genetically susceptible to a medical problem from environmental industrial hazards, which could lead to employment discrimination. Legal protections should be in place for these individuals.

### Cloning and Stem Cell Research

Dolly the sheep, born in July 1996 at Roslin, near Edinburgh, was the first mammal to be cloned from an adult cell, and when her existence was announced about 6 months later the world suddenly became intensely interested in cloning. Dolly was ‘conceived’ by fusing individual mammary gland cells with unfertilized eggs from which the nucleus had been removed; 277 attempts failed before a successful pregnancy ensued. It was immediately assumed that the technology would sooner or later lead to a cloned human being, and there have been some unsubstantiated bogus claims to this effect. However, there has been widespread rejection of any move toward human *reproductive* cloning. Experiments with animals have continued to highlight a very poor success rate, and in some cloned animals the features have suggested possible defects in genomic imprinting. Dolly died prematurely from lung disease and other problems in 2003 but it is notable that her identical cloned siblings have not suffered the same fate.

Nevertheless, the lessons learned from Dolly shifted the focus to *therapeutic* cloning using stem cells, and this has begun to yield some impressive results with respect to treating human disease (p. 210).

The main ethical difficulty in this field relates to the source of stem cells. There is no serious ethical difficulty relating to stem cells harvested from the fully formed person, whether taken from the umbilical cord or the mature adult. But a strong school of scientific opinion maintains that there is no substitute for studying *embryonic* stem cells (ESCs) to understand how cells differentiate from primitive into more complex types. In 2005 the UK Parliament moved swiftly to approve an extension to research on early human embryos for this purpose. Research on human embryos up to 14 days of age was already permitted under the Human Fertilization and Embryology Act 1990. The UK therefore became one of the most attractive places to work in stem cell research because, although regulated, it is legal. Publicly funded research of this kind was not permitted in the USA until a change of political direction in 2009. Progress has been painfully slow for those engaged in this work, and the focus shifted to the creation of animal-human (‘human-admixed’) hybrids and chimeras because of the poor supply and quality of human oocytes (usually ‘leftovers’ from infertility treatment) for use in nuclear cell transfer. In the UK, Newcastle University was granted a license to collect fresh eggs for stem-cell research from egg donors in return for a reduction in the cost of IVF treatment, a decision greeted with alarm in some quarters. This group was also the first, in 2005, to create a human blastocyst after nuclear transfer.

Those who object to the use of ESCs believe it is not only treating the human embryo with disrespect and tampering with the sanctity of life but also could lead eventually to reproductive cloning. The Human Fertilization and Embryology Act of 1990 permits the creation of human embryos for research but very few have been created. This Act was reviewed and updated to accommodate new developments, and came into effect in 2009. The main provisions are listed in [Box 22.8](#) and the ethical debate continues.

### Box 22.8 The Key 2008 Amendments to the Human Fertilization and Embryology Act (HFEA) 1990

- Ensure that all human embryos outside the body—whatever the process used in their creation—are subject to regulation.
- Ensure regulation of ‘human-admixed’ embryos created from a combination of human and animal genetic material for research.
- Ban sex selection of offspring for non-medical reasons. This puts into statute a ban on non-medical sex selection currently in place as a matter of HFEA policy. Sex selection is allowed for medical reasons—for example, to avoid a serious disease that affects only boys.
- Recognize same-sex couples as legal parents of children conceived through the use of donated sperm, eggs, or embryos. These provisions enable, for example, the civil partner of a woman who carries a child via IVF to be recognized as the child’s legal parent.
- Retain a duty to take account of the welfare of the child in providing fertility treatment, but replace the reference to ‘the need for a father’ with ‘the need for supportive parenting’—hence valuing the role of all parents.
- Alter the restrictions on the use of HFEA-collected data to help enable follow-up research of infertility treatment.

### Conclusion

Each new discovery in human molecular genetics and cell biology brings new challenges and raises new dilemmas for which there are often no easy answers. On a global scale it is essential that safeguards are in place to ensure that fundamental principles such as privacy, confidentiality, and respect for human life at all stages and ages are upheld. The medical genetics community can, and should, continue to play a pivotal role in trying to balance the needs of their patients and families with the ethical issues and tensions outlined here. This is an important advocacy role, and towards that end it is hoped that this chapter, and indeed the rest of this book, can make a positive contribution.

### FURTHER READING

- ACMG Board of Directors, 2015. ACMG policy statement: Updated recommendations regarding analysis and reporting of secondary findings in clinical genome-scale sequencing. *Genet. Med.* 17, 68–69. <<https://www.acmg.net/docs/gim2014151a.pdf>>.
- American Society of Human Genetics Report, 1996. Statement on informed consent for genetic research. *Am. J. Hum. Genet.* 59, 471–474.
- The statement of the American Society of Human Genetics Board of Directors on the issues relating to informed consent in genetic research.*
- Baily, M.A., Murray, T.H. (Eds.), 2009. Ethics and newborn genetic screening: New technologies, new challenges. Johns Hopkins University Press, Baltimore.
- A multiauthor volume with a focus on the health economics of newborn screening and distributive justice.*
- British Medical Association, 1998. Human genetics. Choice and responsibility. Oxford University Press, Oxford.
- A comprehensive, wide-ranging report produced by a BMA medical ethics committee steering group on the ethical issues raised by genetics in clinical practice.*
- Bryant, J., Baggott la Velle, L., Searle, J. (Eds.), 2002. Bioethics for scientists. John Wiley, Chichester.
- A multiauthor text of wide scope with many contributions relevant to medical genetics.*

Buchanan, A., Daniels, N., Wikler, D., Brock, D.W., 2000. From chance to choice: Genetics and justice. Cambridge University Press, Cambridge.

*An acclaimed book, intellectually rigorous and wide-ranging, addressing issues related to our knowledge of the human genome.*

Clarke, A. (Ed.), 1997. The genetic testing of children. Bios Scientific, Oxford.

*A comprehensive multiauthor text dealing with this important subject.*

Clothier Committee, 1992. Report of the Committee on the Ethics of Gene Therapy. HMSO, London.

*Recommendations of the committee chaired by Sir Cecil Clothier on the ethical aspects of somatic cell and germline gene therapy.*

Collins, F.S., 1999. Shattuck lecture—medical and societal consequences of the human genome project. *N. Engl. J. Med.* 341, 28–37.

*A contemporary overview of the Human Genome Project with emphasis on its possible ethical and social implications.*

Harper, P.S., Clarke, A.J., 1997. Genetics: society and clinical practice. Bios Scientific, Oxford.

*A thoughtful account of the important ethical and social aspects of recent developments in clinical genetics.*

HM Government, Association of British Insurers 2014 Concordat and Moratorium on Genetics and Insurance. <[https://www.gov.uk/government/uploads/system/uploads/attachment\\_data/file/390174/Genetics\\_and\\_Insurance\\_guidance\\_2014.pdf](https://www.gov.uk/government/uploads/system/uploads/attachment_data/file/390174/Genetics_and_Insurance_guidance_2014.pdf)>.

Human Genetics Commission, 2002. Inside information: balancing interests in the use of personal genetic data. Department of Health, London.

*A detailed working party report by the Human Genetics Commission covering the use and abuse of personal genetic information.*

Jonsen, A.R., Siegler, M., Winslade, W.J., 1992. Clinical ethics: A practical approach to ethical decisions in clinical medicine, third ed. McGraw-Hill, New York.

*The key reference that outlines the Jonsen framework for decision-making in clinical ethics.*

Knoppers, B.M., 1999. Status, sale and patenting of human genetic material: an international survey. *Nat. Genet.* 22, 23–26.

*An article written in the light of a landmark legal and social policy document, the 'Directive on the Legal Protection of Biotechnology Inventions', from the European Parliament, 1998.*

Knoppers, B.M., Chadwick, R., 2005. Human genetic research: Emerging trends in ethics. *Nat. Rev. Genet.* 6, 75–79.

*An overview of international policies on gene patenting.*

Mascalzoni, D., Dove, E.S., Rubinstein, Y., et al., 2015. International charter of principles for sharing bio-specimens and data. *Eur J Hum Genet* 23, 721–728.

*Firm proposals to stimulate open access of information in the genomic era.*

McInnis, M.G., 1999. The assent of a nation: genetics and Iceland. *Clin. Genet.* 55, 234–239.

*A critical review of the complex ethical issues raised by the decision of the Icelandic government to collaborate in genetic research with a biotechnology company.*

Nuffield Council on Bioethics, 1993. Genetic screening: ethical issues. Nuffield Council on Bioethics, London.

*A very helpful document for professional guidance.*

Nuffield Council on Bioethics, 1998. Mental disorders and genetics: The ethical context. Nuffield Council on Bioethics, London.

*A further detailed document dealing with genetic issues in the context of mental health.*

Pokorski, R.J., 1997. Insurance underwriting in the genetic era. *Am. J. Hum. Genet.* 60, 205–216.

*A detailed account of the issues surrounding the use of genetic tests by the insurance industry.*

Royal College of Physicians, Royal College of Pathologists, British Society of Human Genetics: Consent and Confidentiality in Genetic Practice, 2006. Guidance on genetic testing and sharing genetic information. Report of the Joint Committee on Medical Genetics. RCP, RCPPath, BSHG, London.

*A detailed working party report that considers confidentiality issues, especially in the context of the Human Tissue Act 2004.*

## ELEMENTS

- 1 Ethical considerations impinge on almost every aspect of clinical genetics. In a wider context, developments in molecular genetics have important ethical implications for society at large.
- 2 Particularly difficult problems in clinical genetics include prenatal diagnosis and screening, predictive testing in childhood, genetic testing in the extended family, confidentiality, consent, privacy, and disclosure of information.
- 3 Ethical issues on a wider scale, in relation to the possible applications of genetic technologies, include population screening, the handling of secondary (incidental) findings, the electronic storage of large amounts of genetic information, the use of genetic test results by the insurance industry and commercial sector, and gene patenting, gene therapy, and cloning.
- 4 There are no easy or correct solutions for many of the difficult ethical problems that arise in medical genetics. Guidelines, codes of practice, and sometimes regulations, have an important role in establishing and maintaining standards, as well as preserving respect for the individual, the family, and wider societal needs.

# Glossary

- A.** Abbreviation for adenine.
- Acentric.** Lacking a centromere.
- Acetylation.** The introduction of an acetyl group into a molecule; often used by the body to help eliminate substances by the liver.
- Acoustic neuromas.** Tumors of the VIIIth cranial (hearing) nerves that occur in Neurofibromatosis type 2, now known as 'vestibular schwannomas'.
- Acquired.** In genetics, refers to any medical condition not predetermined in the genetic make-up at fertilization (i.e., germline).
- Acquired somatic genetic disease.** Genetic disease caused by gene or chromosomal variants that may occur any time post-fertilization.
- Acrocentric.** Term used to describe a chromosome where the centromere is near one end and the short arm usually consists of satellite material.
- Activation.** In genetics and molecular biology, any event leading to biologically active molecules acquiring the ability to perform their biological function.
- Acute-phase proteins.** Proteins involved in innate immunity produced in reaction to infection, including C-reactive protein, mannose-binding protein, and serum amyloid P component.
- Adaptive immunity.** The ability of the immune system to create immunological memory after an initial response to a specific pathogen.
- Additive.** Relating to genetic risk, the sum of individual effects.
- Adenine.** A purine base in DNA and RNA.
- Adenomatous polyposis coli (APC).** See [Familial adenomatous polyposis](#).
- Adenylate residue.** Pertaining to the nucleic acid purine base-pair 'adenine'.
- Adult stem cell.** Undifferentiated cell found in the body after early development, i.e. not embryonic.
- AIDS.** Acquired immune deficiency syndrome.
- Allele (= allelomorph).** Alternative form of a gene found at the same locus on homologous chromosomes.
- Allelic association.** Next to, or close to, a particular allele of interest.
- Allograft.** A tissue graft between non-identical individuals.
- Allotypes.** Genetically determined variants of antibodies.
- Alpha ( $\alpha$ )-thalassemia.** Inherited disorder of hemoglobin involving underproduction of the  $\alpha$ -globin chains occurring most commonly in people from South-East Asia.
- Alternative pathway.** One of the two pathways of the activation of complement that, in this instance, involves cell membranes of microorganisms.
- Alternative polyadenylation.** Different mRNA transcripts generated by the addition of varying number(s) of adenine residues.
- Alternative splicing.** The process whereby particular exons of a gene may be included, or excluded, from the final, processed mRNA, so that one gene can encode for multiple different proteins.
- Alu repeat.** Short repeated DNA sequences that appear to have homology with transposable elements in other organisms.
- Am.** The group of genetic variants associated with the immunoglobulin (Ig) A heavy chain.
- Amino acid.** An organic compound containing both carboxyl ( $-\text{COOH}$ ) and amino ( $-\text{NH}_2$ ) groups.
- Amniocentesis.** Procedure for obtaining amniotic fluid and cells for prenatal diagnosis.
- Amorph.** A mutation that leads to complete loss of function.
- Amplicon.** A section of DNA or RNA that may be either the source or product of natural or artificial amplification or replication events.
- Amplimer.** An alternative term for 'amplicon'.
- Anaphase.** The stage of cell division when the chromosomes leave the equatorial plate and migrate to opposite poles of the spindle.
- Anaphase lag.** Loss of a chromosome as it moves to the pole of the cell during anaphase; can lead to monosomy.
- Aneuploid.** A chromosome number that is not an exact multiple of the haploid number (i.e.,  $2N - 1$  or  $2N + 1$ , where  $N$  is the haploid number of chromosomes).
- Anterior information.** Information previously known that leads to the prior probability.
- Antibody (= immunoglobulin).** A serum protein formed in response to an antigenic stimulus and reacts specifically with that antigen.
- Anticipation.** The tendency for some autosomal dominant diseases to manifest at an earlier age and/or to increase in severity with each succeeding generation.
- Anticodon.** The complementary triplet of the transfer RNA (tRNA) molecule that binds to it with a particular amino acid.
- Anti-D.** Refers to the Rhesus immune globulin (RhIG) given to Rhesus-negative mothers who have been pregnant with a rhesus-positive infant, to prevent sensitization to the D antigen.
- Antigen.** A substance that elicits the synthesis of antibody with which it specifically reacts.
- Antigen-binding fragment (Fab).** The fragment of the antibody molecule produced by papain digestion responsible for antigen binding.
- Antiparallel.** Opposite orientation of the two strands of a DNA duplex; one runs in the 3' to 5' direction, the other in the 5' to 3' direction.
- Antisense oligonucleotide.** A short oligonucleotide synthesized to bind to a particular RNA or DNA sequence to block its expression.
- Antisense strand.** The template strand of DNA.
- Apical ectodermal ridge.** Area of ectoderm in the developing limb bud that produces growth factors.
- Apolipoproteins.** Proteins involved in lipid transportation in the circulation.
- Apoptosis.** Programmed involution or cell death of a developing tissue or organ of the body.
- Artificial insemination by donor (AID).** Use of semen from a male donor as a reproductive option for couples at high risk of transmitting a genetic disorder.
- Ascertainment.** The finding and selection of families with a hereditary disorder.
- Association.** The occurrence of a particular allele in a group of patients more often than can be accounted for by chance.
- Assortative mating (= non-random mating).** The preferential selection of a spouse with a particular phenotype.
- Atherosclerosis.** Fatty degenerative plaque that accumulates in the intimal wall of blood vessels.
- Autoimmune diseases.** Diseases believed to be caused by the body not recognizing its own antigens.

- Autonomous replication sequences.** DNA sequences that are necessary for accurate replication within yeast.
- Autonomy.** In medical ethics, the principle of a rational individual making an informed, un-coerced decision.
- Autoradiography.** Detection of radioactively labeled molecules on an X-ray film.
- Autosomal dominant.** A gene on one of the non-sex chromosomes that manifests in the heterozygous state.
- Autosomal inheritance.** The pattern of inheritance shown by a disorder or trait determined by a gene on one of the non-sex chromosomes.
- Autosomal recessive.** A gene located on one of the non-sex chromosomes that manifests in the homozygous state.
- Autosome.** Any of the 22 non-sex chromosomes.
- Autozygosity.** Homozygosity as a result of identity by descent from a common ancestor.
- Autozygosity mapping.** The technique used to identify a disease locus based on the principle of homozygosity by descent from a common ancestor.
- Axonal.** Relates to the axon – the long slender projection of a nerve cell (neuron).
- Azoospermia.** Absence of sperm in semen.
- B lymphocytes.** Antibody-producing lymphocytes involved in humoral immunity.
- Bacterial artificial chromosome (BAC).** An artificial chromosome created from modification of the fertility factor of plasmids that allows incorporation of up to 330 kb of foreign DNA.
- Bacteriophage (= phage).** A virus that infects bacteria.
- Balanced polymorphism.** Two different genetic variants that are stably present in a population (i.e., selective advantages and disadvantages cancel each other out).
- Balanced translocation.** See [Reciprocal translocation](#).
- Bare lymphocyte syndrome.** A rare autosomal recessive form of severe combined immunodeficiency resulting from absence of the class II molecules of the major histocompatibility complex.
- Barr body.** The condensation of the inactive X chromosome seen in the nucleus of certain types of cells from females. See [Sex chromatin](#).
- Base.** Short for the nitrogenous bases in nucleic acid molecules (A, adenine; T, thymine; U, uracil; C, cytosine, G, guanine).
- Base excision repair.** One of the cellular mechanisms that repairs damaged DNA throughout the cell cycle.
- Base pair (bp).** A pair of complementary bases in DNA (A with T, G with C).
- Bayes' theorem.** Combining the prior and conditional probabilities of certain events or the results of specific tests to give a joint probability to derive the posterior or relative probability.
- Beauchamp and Childress framework.** The universally acknowledged principles of medical ethics.
- Bence Jones protein.** The antibody of a single species produced in large amounts by a person with multiple myeloma, a tumor of antibody-producing plasma cells.
- Beneficence.** The principle of doing good in medical ethics.
- Beta ( $\beta$ )-thalassemia.** Inherited disorder of hemoglobin involving underproduction of the  $\beta$ -globin chain, occurring most commonly in people from the Mediterranean region and Indian subcontinent.
- Bias of ascertainment.** An artifact that must be taken into account in family studies when looking at segregation ratios, caused by families coming to attention because they have affected individual(s).
- Bilaminar.** Two-layered – in cell biology referring to two layers of cells.
- Biochemical disorder.** An inherited disorder involving a metabolic pathway (i.e., an inborn error of metabolism).
- Biochemical genetics.** In general, the discipline that concentrates on the diagnosis and management of inborn errors of metabolism.
- Bioinformatics.** The science of interpreting the significance of data generated by molecular genetics and DNA sequencing.
- Biological or genetic determinism.** The premise that our genetic makeup is the only factor determining all aspects of our health and disease.
- Biosynthesis.** Use of recombinant DNA techniques to produce molecules of biological and medical importance in the laboratory or commercially.
- Bipolar illness.** Affective manic–depressive illness.
- Bivalent.** A pair of synapsed homologous chromosomes.
- Blastocyst.** Early embryo consisting of embryoblast and trophoblast.
- Blastomere.** A single cell of the early fertilized conceptus.
- Blighted ovum.** The fertilization of an egg (ovum) by a sperm that leads to a non-viable embryo.
- Blood chimera.** A mixture of cells of different genetic origin present in twins as a result of an exchange of cells via the placenta between non-identical twins in utero.
- Boundary elements.** Short sequences of DNA, usually from 500 bp to 3 kb in size, that block or inhibit the influence of regulatory elements of adjacent genes.
- Break-point cluster (bcr).** Region of chromosome 22 involved in the translocation seen in the majority of people with chronic myeloid leukemia.
- C.** Abbreviation for cytosine.
- CAAT box.** A conserved, non-coding, so-called promoter sequence about 80 bp upstream from the start of transcription.
- Café-au-lait.** Refers to coffee-colored patches of skin.
- Cancer family syndrome.** Clustering in certain families of particular types of cancers, in which it has been proposed that the different types of malignancy could be due to a single dominant gene, specifically Lynch type II.
- Cancer genetics.** The study of the genetic causes of cancer.
- Candidate gene.** A gene whose function or location suggests that it is likely to be responsible for a particular genetic disease or disorder.
- 5' Cap.** Modification of the nascent mRNA by the addition of a methylated guanine nucleotide to the 5' end of the molecule by an unusual 5' to 5' triphosphate linkage.
- CA repeat.** A short dinucleotide sequence present as tandem repeats at multiple sites in the human genome, producing microsatellite polymorphisms.
- Carrier.** Person heterozygous for a recessive gene; male or female for autosomal genes or female for X-linked genes.
- Cascade screening.** Identification within a family of carriers for an autosomal recessive disorder or people with an autosomal dominant gene after ascertainment of an index case.
- Case control study.** A form of observational research; in medicine a cohort of patients with a defined condition are compared with a group matched for other characteristics.
- Cell-free fetal DNA.** DNA from the fetus (derived from placental trophoblast tissue) that reaches the maternal circulation.
- Cell-mediated immunity.** Immunity that involves the T lymphocytes in fighting intracellular infection; is also involved in transplantation rejection and delayed hypersensitivity.
- Cellular oncogene.** See [Proto-oncogene](#).
- Centimorgan (cM).** Unit used to measure map distances, equivalent to a 1% chance of recombination (crossing over).
- Central dogma.** The concept that genetic information is usually transmitted only from DNA to RNA to protein.
- Centric fusion.** The fusion of the centromeres of two acrocentric chromosomes to form a Robertsonian translocation.
- Centriole.** The cellular structure from which microtubules radiate in the mitotic spindle involved in the separation of chromosomes in mitosis.
- Centromere (= kinetochore).** The point at which the two chromatids of a chromosome are joined and the region of the chromosome that becomes attached to the spindle during cell division.
- Chain termination mutation.** A coding DNA variant that converts an amino acid codon into a termination codon.

- Chemotaxis.** The attraction of phagocytes to the site of infection by components of complement.
- Chiasmata.** Crossovers between chromosomes in meiosis.
- Chimera.** An individual composed of two populations of cells with different genotypes.
- Chimeric gene.** A novel gene (and its protein) composed of two coding regions fused together, often due to a replication error or translocation.
- Chorion.** Layer of cells covering a fertilized ovum, some of which (the chorion frondosum) will later form the placenta.
- Chorionic villus sampling.** Procedure using ultrasonographic guidance to obtain chorionic villi from the chorion frondosum for prenatal diagnosis.
- Chromatid.** During cell division, each chromosome divides longitudinally into two strands, or chromatids, which are held together by the centromere.
- Chromatin.** The tertiary coiling of the nucleosomes of the chromosomes with associated proteins.
- Chromatin fiber.** A 30 nanometer diameter 'beads on a string' structure consisting of nucleosome (DNA and histone protein) arrays in their most compact form.
- Chromatin fiber FISH.** Use of extended chromatin or DNA fibers with fluorescent in situ hybridization (FISH) to order physically DNA clones or sequences.
- Chromosomal analysis.** The process of counting and analyzing the banding pattern of the chromosomes of an individual.
- Chromosomal fragments.** Acentric chromosomes that can arise as a result of segregation of a paracentric inversion and that are usually incapable of replication.
- Chromosome.** Thread-like, darkly staining body within the nucleus composed of DNA and chromatin that carries the genetic information.
- Chromosome instability.** The presence of breaks and gaps in the chromosomes from people with a number of disorders associated with an increased risk of neoplasia.
- Chromosome mapping.** Assigning a gene or DNA sequence to a specific chromosome or a particular region of a chromosome.
- Chromosome-mediated gene transfer.** The technique of transferring chromosomes or parts of chromosomes to somatic cell hybrids to enable more detailed chromosome mapping.
- Chromosome painting.** The hybridization in situ of fluorescent-labeled probes to a chromosome preparation to allow identification of a particular chromosome(s).
- Chromosome walking.** Using an ordered assembly of clones to extend from a known start point.
- Cis-acting.** Regulatory elements in the promoter region that act on genes on the same chromosome.
- Class switching.** The normal change in antibody class from IgM to IgG in the immune response.
- Classic gene families.** Multigene families that show a high degree of sequence homology.
- Classic pathway.** One of the two ways of activation of complement, in this instance involving antigen-antibody complexes.
- Clone.** A group of cells, all of which are derived from a single cell by repeated mitoses and all having the same genetic information.
- Clone contigs.** Assembly of clones that have been mapped and ordered to produce an overlapping array.
- Cloning *in silico*.** The use of a number of computer programs that can search genomic DNA sequence databases for sequence homology to known genes, as well as DNA sequences specific to all genes such as the conserved intron/exon splice junctions, promoter sequences, polyadenylation sites and stretches of open-reading frames (ORFs) to identify novel genes.
- cM.** Abbreviation for centimorgan.
- Co-dominance.** When both alleles are expressed in the heterozygote.
- Codon.** A sequence of three adjacent nucleotides that codes for one amino acid or chain termination.
- Common cancers.** The cancers that occur commonly in humans, such as bowel and breast cancer.
- Common diseases.** The diseases that occur commonly in humans (e.g., cancer, coronary artery disease, diabetes).
- Community genetics.** The branch of medical genetics concerned with screening and the prevention of genetic diseases on a population basis.
- Comparative genomic hybridization.** A method of analyzing genomic material by comparing the genome of interest with a reference sample to identify copy number variation.
- Comparative genomics.** The identification of orthologous genes in different species.
- Competent.** Making bacterial cell membrane permeable to DNA by a variety of different methods, including exposure to certain salts or high voltage.
- Complement.** A series of at least 10 serum proteins in humans (and other vertebrates) that can be activated by either the 'classic' or the 'alternative' pathway and that interact in sequence to bring about the destruction of cellular antigens.
- Complementary DNA (cDNA).** DNA synthesized from mRNA by the enzyme reverse transcriptase.
- Complementary strands.** The specific pairing of the bases in the DNA of the purines adenine and guanine with thymine and cytosine.
- Complete ascertainment.** A term used in segregation analysis for a type of study that identifies all affected individuals in a population.
- Complex trait.** A genetic disease or characteristic that is not associated with a single gene (i.e., Mendelian) but caused by multiple DNA variants.
- Compound heterozygote.** An individual who is affected with an autosomal recessive disorder having two different mutations in homologous genes.
- Concordance.** When both members of a pair of twins exhibit the same trait, they are said to be concordant. If only one twin has the trait, the twins are said to be discordant.
- Conditional knockout.** A mutation that is expressed only under certain conditions (e.g., raised temperature).
- Conditional probability.** Observations or tests that can be used to modify prior probabilities using Bayesian calculation in risk estimations.
- Conditionally toxic or suicide gene.** Genes that are introduced in gene therapy and that, under certain conditions or after the introduction of a certain substance, will kill the cell.
- Confined placental mosaicism.** The occurrence of a chromosomal abnormality in chorionic villus samples obtained for first-trimester prenatal diagnosis in which the fetus has a normal chromosomal complement.
- Congenital.** Any abnormality, whether genetic or not, that is present at birth.
- Congenital hypertrophy of the retinal pigment epithelium (CHRPE).** Abnormal retinal pigmentation that, when present in people at risk for familial adenomatous polyposis, is evidence of the heterozygous state.
- Conjugation.** A chemical process in which two molecules are joined, often used to describe the process by which certain drugs or chemicals can then be excreted by the body (e.g., acetylation of isoniazid by the liver).
- Consanguineous.** The union (mating) between two people descended from a common ancestor. In genetics this refers to the union between two people who are no further removed than a second cousin relationship.
- Consensus sequence.** A GGGCGGG sequence promoter element to the 5' side of genes in eukaryotes involved in the control of gene expression.
- Conservative substitution.** Single base-pair substitution that, although resulting in the replacement by a different amino acid, if chemically similar, has no functional effect.
- Constant (C).** An unchanging value.



- Constant region.** The portion of the light and heavy chains of antibodies in which the amino acid sequence is relatively constant from molecule to molecule.
- Constitutional.** Present in the fertilized gamete.
- Constitutional heterozygosity.** The presence in an individual at the time of conception of obligate heterozygosity at a locus when the parents are homozygous at that locus for different alleles.
- Consultand.** The person presenting for genetic advice.
- Contigs.** Contiguous or overlapping DNA clones.
- Contiguous gene syndrome.** Disorder resulting from deletion of adjacent genes.
- Continuous trait.** A trait, such as height, for which there is a range of observations or findings, in contrast to traits that are all or none (see [Discontinuous trait](#)), such as cleft lip and palate.
- Control gene.** A gene that can turn other genes on or off (i.e., regulate).
- Cordocentesis.** The procedure of obtaining fetal blood samples for prenatal diagnosis.
- Corona radiata.** Cellular layer surrounding the mature oocyte.
- Cor pulmonale.** Right-sided heart failure that can occur after serious lung disease, such as in people with cystic fibrosis.
- Correlation.** Statistical measure of the degree of association or resemblance between two parameters.
- Cosmid.** A plasmid that has had the maximum DNA removed to allow the largest possible insert for cloning but still has the DNA sequences necessary for in vitro packaging into an infective phage particle.
- Co-twins.** Both members of a twin pair, whether dizygotic or monozygotic.
- Counselee.** Person receiving genetic counseling.
- Couple screening.** The practice of conducting genetic screening for both members of a mating partnership at the same time.
- Coupling.** When a certain allele at a particular locus is on the same chromosome with a specific allele at a closely linked locus.
- CpG dinucleotides.** The occurrence of the nucleotides cytosine and guanine together in genomic DNA, which is frequently methylated and associated with spontaneous deamination of cytosine converting it to thymine as a mechanism of mutation.
- CpG islands.** Clusters of unmethylated CpGs occur near the transcription sites of many genes.
- Crossover (= recombination).** The exchange of genetic material between homologous chromosomes in meiosis.
- Cross-reacting material (CRM).** Immunologically detected protein or enzyme that is functionally inactive.
- Cryptic splice site.** A mutation in a gene leading to the creation of the sequence of a splice site that results in abnormal splicing of the mRNA.
- Culture artifact.** In genetics, a chromosome aberration that arises *in vitro*, thus misrepresenting the situation *in vivo*.
- Cycling gene.** In development, a gene that is expressed in oscillatory, or periodic cycles.
- Cystic fibrosis transmembrane conductance regulator (CFTR).** The gene product of the cystic fibrosis gene responsible for chloride transport and mucin secretion.
- Cytogenetics.** The branch of genetics concerned principally with the study of chromosomes.
- Cytokinesis.** Division of the cytoplasm to form two daughter cells in meiosis and mitosis.
- Cytoplasm.** The ground substance of the cell, in which are situated the nucleus, endoplasmic reticulum, or mitochondria.
- Cytoplasmic inheritance.** See [Mitochondrial inheritance](#).
- Cytosine.** A pyrimidine base in DNA and RNA.
- Cytosol.** The semi-soluble contents of the cytoplasm.
- Cytotoxic T cells.** A subclass of T lymphocytes sensitized to destroy cells bearing certain antigens.
- Cytotoxic T lymphocytes (= killer).** A group of T cells that specifically kill foreign or virus-infected vertebrate cells.
- Daltonism.** A term given formerly to X-linked inheritance, after John Dalton, who noted this pattern of inheritance in color blindness.
- Deformation.** A birth defect that results from an abnormal mechanical force which distorts an otherwise normal structure.
- Degeneracy.** Certain amino acids being coded for by more than one triplet codon of the genetic code.
- Deleted in colorectal carcinoma (DCC).** A region on the long arm of chromosome 18 often found to be deleted in colorectal carcinomas.
- Deletion.** A type of chromosomal aberration or mutation at the DNA level in which there is loss of part of a chromosome or of one or more nucleotides.
- Delta-beta ( $\delta\beta$ )-thalassemia.** A form of thalassemia in which there is reduced production of both the  $\delta$ - and  $\beta$ -globin chains.
- Demyelinating.** The process of a nerve fiber (neuron) losing its insulating myelin sheath.
- De novo.** Literally 'from new', as opposed to inherited.
- Deoxyribonucleic acid.** See [DNA](#).
- Desert hedgehog.** One of three mammalian homologs of the segment polarity hedgehog genes.
- Dicentric.** Possessing two centromeres.
- Dictyotene.** The stage in meiosis I in which primary oocytes are arrested in females until the time of ovulation.
- Digenic inheritance.** An inheritance mechanism resulting from the interaction of two non-homologous genes.
- Diploid.** The condition in which the cell contains two sets of chromosomes. Normal state of somatic cells in humans where the diploid number (2N) is 46.
- Discontinuous trait.** A trait that is all or none (e.g., cleft lip and palate), in contrast to continuous traits such as height.
- Discordant.** Differing phenotypic features between individuals, classically used in twin pairs.
- Disease allele.** A pathogenic variant in one copy of a DNA sequence.
- Disomy.** The normal state of an individual having two homologous chromosomes.
- Dispermic chimera.** Two separate sperm fertilize two separate ova and the resulting two zygotes fuse to form one embryo.
- Dispermy.** Fertilization of an oocyte by two sperm.
- Disruption.** An abnormal structure of an organ or tissue as a result of external factors disturbing the normal developmental process.
- Diversity (D).** In genetics, the total number of characteristics in the genetic make-up (of a species).
- Diversity region.** DNA sequences coding for the segments of the hypervariable regions of antibodies.
- Dizygotic twins (= fraternal).** Type of twins produced by fertilization of two ova by two sperm.
- DNA (= deoxyribonucleic acid).** The nucleic acid in chromosomes in which genetic information is coded.
- DNA chip.** DNA microarrays that, with the appropriate computerized software allow rapid, automated, high-throughput DNA sequencing and mutation detection.
- DNA fingerprint.** Pattern of hypervariable tandem DNA repeats of a core sequence that is unique to an individual.
- DNA haplotype.** The pattern of DNA sequence polymorphisms flanking a DNA sequence or gene of interest.
- DNA library.** A collection of recombinant DNA molecules from a particular source, such as genomic or cDNA.
- DNA ligase.** An enzyme that catalyzes the formation of a phosphodiester bond between a 3'-hydroxyl and a 5'-phosphate group in DNA, thereby joining two DNA fragments.
- DNA mapping.** The physical relationships of flanking DNA sequence, polymorphisms, and the detailed structure of a gene.
- DNA polymorphisms.** Inherited variation in the nucleotide sequence, usually of non-coding DNA.

- DNA probes.** A DNA sequence that is labeled, usually radioactively or fluorescently, and used to identify a gene or DNA sequence (e.g., a cDNA or genomic probe).
- DNA repair.** DNA damaged through a variety of mechanisms can be removed and repaired by a complex set of processes.
- DNA replication.** The process of copying the nucleotide sequence of the genome from one generation to the next.
- DNA sequence amplification.** See [Polymerase chain reaction](#).
- DNA sequence variants.** See [DNA polymorphisms](#).
- DNA sequencing.** Analysis of the nucleotide sequence of a gene or DNA fragment.
- Dominant.** A trait expressed in individuals who are heterozygous for a particular allele.
- Dominant-negative mutation.** A mutant allele in the heterozygous state that results in the loss of activity or function of its mutant gene product as well as interfering with the function of the normal gene product of the corresponding allele.
- Donor insemination.** In seeking to achieve a pregnancy, the use of sperm from a individual who is not the normal male sexual partner.
- Dosage compensation.** The phenomenon in women who have two copies of genes on the X chromosome having the same level of the products of those genes as males who have a single X chromosome.
- Dosimetry.** The measurement of radiation exposure.
- Double heterozygote.** An individual who is heterozygous at two different loci.
- Double-minute chromosomes.** Amplified sequences of DNA in tumor cells that can occur as small extra chromosomes, as in neuroblastoma.
- Downstream.** Relating to DNA and RNA, in the direction of the 3' end (finish) of the molecule.
- Drift (= random genetic drift).** Fluctuations in gene frequencies that tend to occur in small isolated populations.
- Duplication.** In genetics, the presence of an extra copy of DNA or chromosome material.
- Dynamic mutation.** See [Unstable mutation](#).
- Dysmorphology.** The study of the definition, recognition, and etiology of multiple malformation syndromes.
- Dysplasia.** An abnormal organization of cells into tissue.
- Dystrophin.** The product of the Duchenne muscular dystrophy gene.
- Ecogenetics.** The study of genetically determined differences in susceptibility to the action of physical, chemical and infectious agents in the environment.
- Ectoderm.** The outer layer of the three layers of cells in the early embryo; from this layer is formed the skin, hair, nails, teeth, sweat glands and nervous system.
- Em.** The group of genetic variants of the IgE heavy chain of immunoglobulins.
- Embryoblast.** Cell layer of the blastocyst which forms the embryo.
- Embryonic stem cells.** A cell in the early embryo that is totipotent in terms of cellular fate.
- Empiric risks.** Advice given in recurrence risk counseling for multifactorially determined disorders based on observation and experience, in which the inherited contribution is due to a number of genes (i.e., polygenic).
- Endoderm.** The innermost layer of the three layers of cells in the early embryo; from this layer is formed the gut, respiratory and urinary systems, endocrine organs, and auditory system.
- Endoplasmic reticulum.** A system of minute tubules within the cell involved in the biosynthesis of macromolecules.
- Endoreduplication.** Duplication of a haploid sperm chromosome set.
- Enhancer.** DNA sequence that increases transcription of a related gene.
- Enzyme.** A protein that acts as a catalyst in biological systems.
- Epidermal growth factor (EGF).** A growth factor that stimulates a variety of cell types including epidermal cells.
- Epigenetic.** Heritable changes to gene expression that are *not* due to differences in the genetic code.
- Epistasis.** Interaction between non-allelic genes.
- Erythroblastosis fetalis.** See [Hemolytic disease of the newborn](#).
- Essential hypertension.** Increased blood pressure for which there is no recognized primary cause.
- Etiological heterogeneity.** In medicine, refers to a variety of different causes for a condition.
- Euchromatin.** Genetically active regions of the chromosomes.
- Eugenics.** The 'science' that promotes the improvement of the hereditary qualities of a race or a species.
- Eukaryote.** Higher organism with a well-defined nucleus.
- Exome.** That part of the genome formed by exons, i.e. coding regions of genes (comprises just ~1% of the total genome).
- Exon (= expressed sequence).** Region of a gene that is not excised during transcription, forming part of the mature mRNA, and therefore specifying part of the primary structure of the gene product.
- # Exon splicing enhancer (ESE).** A DNA sequence consisting of 6 bases within an exon, which directs or enhances accurate splicing of nuclear RNA into messenger RNA.
- Exon trapping.** A process by which a recombinant DNA vector that contains the DNA sequences of the splice-site junctions is used to clone coding sequences or exons.
- Expansion.** Refers to the increase in the number of triplet repeat sequences in the various disorders due to dynamic or unstable mutations.
- Expressed sequence tags.** Sequence-specific primers from cDNA clones designed to identify sequences of expressed genes in the genome.
- Expressivity.** Variation in the severity of the phenotypic features of a particular gene.
- Extinguished.** Loss of one allelic variant at a locus resulting from random genetic drift.
- Extrinsic malformation.** Term previously used for disruption.
- Fab.** The two antigen-binding fragments of an antibody molecule produced by digestion with the proteolytic enzyme papain.
- False negative.** Affected cases missed by a diagnostic or screening test.
- False positive.** Unaffected cases incorrectly diagnosed as affected by a screening or diagnostic test.
- Familial adenomatous polyposis.** A dominantly inherited cancer-predisposing syndrome characterized by the presence of a large number of polyps of the large bowel with a high risk of developing malignant changes.
- Familial cancer-predisposing syndrome.** One of a number of syndromes in which people are at risk of developing one or more types of cancer.
- Favism.** A hemolytic crisis resulting from glucose 6-phosphate dehydrogenase (G6PD) deficiency occurring after eating fava beans.
- Fc.** The complement binding fragment of an antibody molecule produced by digestion with the proteolytic enzyme papain.
- Fetoscopy.** Procedure used to visualize the fetus and often to take skin and/or blood samples from the fetus for prenatal diagnosis.
- Fetus.** Unborn infant during the final stage of in utero development, usually from 12 weeks' gestation to term.
- Filial.** Relating to offspring.
- First-degree relatives.** Closest relatives (i.e., parents, offspring, siblings), sharing on average 50% of their genes.
- Fitness (= biological fitness).** The number of offspring who reach reproductive age.
- Five-prime (5') end.** The end of a DNA or RNA strand with a free 5' phosphate group.
- Fixed.** The establishment of a single allelic variant at a locus from random genetic drift.
- Fixed mutation.** See [Stable mutation](#).
- Flanking DNA.** Nucleotide sequence adjacent to the DNA sequence being considered.

- Flanking markers.** Polymorphic markers that are located adjacent to a gene or DNA sequence of interest.
- Flow cytometry.** See [Fluorescence-activated cell sorting](#).
- Flow karyotype.** A distribution histogram of chromosome size obtained using a fluorescence-activated cell sorter.
- Fluorescence-activated cell sorting (FACS).** A technique in which chromosomes are stained with a fluorescent dye that binds selectively to DNA; the differences in fluorescence of the various chromosomes allow them to be physically separated by a special laser.
- Fluorescent in situ hybridization (FISH).** Use of a single-stranded DNA sequence with a fluorescent label to hybridize with its complementary target sequence in the chromosomes, allowing it to be visualized under ultraviolet light.
- Foreign DNA.** A source of DNA incorporated into a vector in producing recombinant DNA molecules.
- Founder effect.** Certain genetic disorders can be relatively common in particular populations through all individuals being descended from a relatively small number of ancestors, one or a few of whom had a particular disorder.
- Founder haplotype.** A pattern of DNA variation, usually relating to a locus of interest, that traces unchanged back to an ancestor who was the first individual in a population with a particular disease.
- Fragile site.** A non-staining gap in a chromatid where breakage is liable to occur.
- Frameshift mutations.** Mutations, such as insertions or deletions, that change the reading frame of the codon triplets.
- Framework map.** A set of markers distributed at defined approximately evenly spaced intervals along the chromosomes in the human genome.
- Framework region.** Parts of the variable regions of antibodies that are not hypervariable.
- Fraternal twins.** Non-identical twins.
- Freemartin.** A chromosomally female twin calf with ambiguous genitalia resulting from gonadal chimerism.
- Frequency.** The number of times an event occurs in a period (e.g., 1000 cases per year).
- Full ascertainment.** See [Complete ascertainment](#).
- Functional cloning.** Identification of a gene through its function (e.g., isolation of cDNAs expressed in a particular tissue in which a disease or disorder is manifest).
- Functional genomics.** The normal pattern of expression of genes in development and differentiation and the function of their protein products in normal development as well as their dysfunction in inherited disorders.
- Fusion polypeptide.** Genes that are physically near to one another and have DNA sequence homology can undergo a crossover, leading to formation of a protein that has an amino acid sequence derived from both of the genes involved.
- Fusion polypeptide.** A protein that results from a fusion (chimeric) gene.
- Fusion protein.** Same as Fusion polypeptide.
- G.** Abbreviation for the nucleotide guanine.
- Gain-of-function.** Mutations that, in the heterozygote, result in new functions.
- Gain of methylation.** The principle mechanism of epigenetics whereby DNA is methylated to alter its expression.
- Gamete.** A cell that fuses with another to bring about fertilization, or sexual reproduction, i.e. egg or sperm cells.
- Gap mutant.** Developmental genes identified in *Drosophila* that delete groups of adjacent segments.
- Gastrulation.** The formation of the bi- then tri-laminar disc of the inner cell mass that becomes the early embryo.
- Gene.** A part of the DNA molecule of a chromosome that directs the synthesis of a specific polypeptide chain.
- Gene amplification.** Process in tumor cells of the production of multiple copies of certain genes, the visible evidence of which are homogeneously staining regions and double-minute chromosomes.
- Gene flow.** Differences in allele frequencies between populations that reflect migration or contact between them.
- Gene superfamilies.** Multigene families that have limited sequence homology but are functionally related.
- Gene targeting.** The introduction of specific mutations into genes by homologous recombination in embryonic stem cells.
- Gene therapy.** Treatment of inherited disease by addition, insertion, or replacement of a normal gene or genes.
- Genetic code.** The triplets of DNA nucleotides that code for the various amino acids of proteins.
- Genetic counseling.** The process of providing information about a genetic disorder that includes details about the diagnosis, cause, risk of recurrence, and options available for prevention.
- # Genetic enhancement.** The controversial concept of modifying DNA to bring about 'improvement', which encompasses elimination of a genetic disease as well as alteration of characteristics.
- Genetic heterogeneity.** The phenomenon that a disorder can be caused by different allelic or non-allelic mutations.
- Genetic isolates.** Groups isolated for geographical, religious, or ethnic reasons that often show differences in allele frequencies.
- Genetic load.** The total of all kinds of harmful alleles in a population.
- Genetic register.** A list of families and individuals who are either affected by or at risk of developing a serious hereditary disorder.
- Genetic susceptibility.** An inherited predisposition to a disease or disorder that is not due to a single-gene cause and is usually the result of a complex interaction of the effects of multiple different genes (i.e., polygenic inheritance).
- Genocopy.** The same phenotype but from different genetic causes.
- Genome.** The entire genetic material of a cell, including coding and non-coding DNA.
- Genome-wide association study (GWAS).** An examination of genetic variants across the entire genome, usually comparing a cohort of subjects with a defined phenotype or disease.
- Genome-wide scan.** Usually refers to a mapping study using probes across the entire genome, e.g. in a large family with a Mendelian disorder.
- Genomic DNA.** The total DNA content of the chromosomes.
- Genomic imprinting.** Differing expression of genetic material dependent on the sex of the transmitting parent.
- Genotype.** The genetic constitution of an individual.
- Genotype-phenotype correlation.** Correlation of certain mutations with particular phenotypic features.
- Germ cells.** The cells of the body that transmit genetic information to the next generation.
- Germline.** The population of the body's cells so differentiated that in the usual processes of reproduction they may pass on their genetic material to the offspring.
- Germline gene therapy.** The alteration or insertion of genetic material in the gametes.
- Germline mosaicism.** The presence in the germline or gonadal tissue of two populations of cells that differ genetically.
- Germline mutation.** A mutation in a gamete.
- Gestational.** Pertaining to events during pregnancy.
- Gestational diabetes.** Onset of an abnormal glucose tolerance in pregnancy that usually reverts to normal after delivery.
- Ghent criteria.** A system, devised by an expert working party that met in Ghent, Belgium, for scoring physical characteristics in assessing a patient for possible Marfan syndrome.
- Gm.** Genetic variants of the heavy chain of IgG immunoglobulins.
- Goldberg-Hogness box.** See [CAAT box](#).
- Gonad dose.** Radiation dosimetry term that describes the radiation exposure of an individual to a particular radiological investigation or exposure.
- Gonadal mosaicism.** See [Germline mosaicism](#).
- Gonadal tissue.** Cells and tissue of the organs producing sex cells, i.e. ovaries and testes.
- Gray (Gy).** Equivalent to 100 rad.

- Growth factor.** A substance that must be present in culture medium to permit cell multiplication, or involved in promoting the growth of certain cell types, tissues, or parts of the body in development (e.g., fibroblast growth factor).
- Growth factor receptors.** Receptors on the surfaces of cells for a growth factor.
- Guanine.** A purine base in DNA and RNA.
- Hamartoma.** A benign, non-malignant, focal malformation resembling a neoplasm in the tissue from which it originates and growing in a disorganized mass.
- Haploid.** The condition in which the cell contains one set of chromosomes (i.e., 23). This is the chromosome number in a normal gamete.
- Haploinsufficiency.** Mutations in the heterozygous state that result in half normal levels of the gene product leading to phenotypic effects (i.e., are sensitive to gene dosage).
- Haplotype.** Conventionally used to refer to the particular alleles present at the four genes of the HLA complex on chromosome 6. The term is also used to describe DNA sequence variants on a particular chromosome adjacent to or closely flanking a locus of interest.
- Hardy-Weinberg equilibrium.** The maintenance of allele frequencies in a population with random mating and absence of selection.
- Hardy-Weinberg formula.** A simple binomial equation in population genetics that can be used to determine the frequency of the different genotypes from one of the phenotypes.
- Hardy-Weinberg principle.** The relative proportions of the different genotypes remain constant from one generation to the next.
- Hb Barts.** The tetramer of  $\gamma$ -globin chains found in the severe form of  $\alpha$ -thalassemia, which causes hydrops fetalis.
- Hb H.** Tetramer of the  $\beta$ -globin chains found in the less severe form of thalassemia.
- Hedgehog.** A group of morphogens produced by segment polarity genes.
- Helix-loop-helix.** DNA-binding motif that controls gene expression.
- Helix-turn-helix proteins.** Proteins made up of two 'a' helices connected by a short chain of amino acids that make up a 'turn.'
- Helper lymphocytes.** A subclass of T lymphocytes necessary for the production of antibodies by B lymphocytes.
- Helper virus.** A retroviral provirus engineered to remove all but the sequences necessary to produce copies of the viral RNA sequences along with the sequences necessary for packaging of the viral genomic RNA in retrovirus-mediated gene therapy.
- Heme.** The iron-containing group of hemoglobin.
- Hemizygous.** A term used when describing the genotype of a male with regard to an X-linked trait, as males have only one set of X-linked genes.
- Hemoglobin electrophoresis.** The technique that separates different hemoglobin molecules in order to diagnose specific inherited blood disorders.
- Hemoglobinopathy.** An inherited disorder of hemoglobin.
- Hemolytic disease of the newborn.** Anemia resulting from an antibody produced by a Rh-negative mother to the Rh-positive blood group of the fetus crossing the placenta and causing hemolysis. If this hemolytic process is severe, it can cause death of the fetus from heart failure because of the anemia, or what is known as hemolytic disease of the newborn.
- Hereditary persistence of fetal Hb (HPFH).** Persistence of the production of fetal hemoglobin into childhood and adult life.
- Heritability.** The proportion of the total variation of a character attributable to genetic as opposed to environmental factors.
- Hermaphrodite.** An individual with both male and female gonads, often in association with ambiguous external genitalia (this term is now out of favor, with Disorders of Sex Development preferred).
- Heterochromatin.** Genetically inert or inactive regions of the chromosomes.
- Heterogeneity.** The phenomenon of there being more than a single cause for what appears to be a single entity. See [Genetic heterogeneity](#).
- Heteromorphism.** An inherited structural polymorphism of a chromosome.
- Heteroplasmy.** The mitochondria of an individual consisting of more than one population.
- Heteropyknotic.** Condensed darkly staining chromosomal material (e.g., the inactivated X chromosome in females).
- Heterozygote (= carrier).** An individual who possesses two different alleles at one particular locus on a pair of homologous chromosomes.
- Heterozygote advantage.** An increase in biological fitness seen in unaffected heterozygotes compared with unaffected homozygotes (e.g., sickle cell trait and resistance to infection by the malarial parasite).
- Heterozygous.** The state of having different alleles at a locus on homologous chromosomes.
- High-resolution DNA mapping.** Detailed physical mapping at the level of restriction site polymorphisms, expressed sequence tags, and so on.
- Histocompatibility.** Antigenic similarity of donor and recipient in organ transplantation.
- Histone.** Type of protein rich in lysine and arginine found in association with DNA in chromosomes.
- HIV.** Human immunodeficiency virus.
- HLA (human leukocyte antigen).** Antigens present on the cell surfaces of various tissues, including leukocytes.
- HLA complex.** The genes on chromosome 6 responsible for determining the cell-surface antigens important in organ transplantation.
- Hogness box (= TATA box).** A conserved, non-coding, so-called promoter sequence about 30 bp upstream from the start of transcription.
- Holandric inheritance.** The pattern of inheritance of genes on the Y chromosome; only males are affected and the trait is transmitted by affected males to their sons but to none of their daughters.
- Homeobox.** A stretch of approximately 180 bp conserved in different homeotic genes.
- Homeotic gene.** Genes that are involved in controlling the development of a region or compartment of an organism producing proteins or factors that regulate gene expression by binding particular DNA sequences.
- Homogeneously staining regions (HSRs).** Amplification of DNA sequences in tumor cells that can appear as extra or expanded areas of the chromosomes, which stain evenly.
- Homograft.** Graft between individuals of the same species but with different genotypes.
- Homologous chromosomes.** Chromosomes that pair during meiosis and contain identical loci.
- Homologous recombination.** The process by which a DNA sequence can be replaced by one with a similar sequence to determine the effect of changes in DNA sequence in the process of site-directed mutagenesis.
- Homology.** Genes or DNA sequences related by common ancestry.
- Homoplasmy.** The mitochondria of an individual consisting of a single population.
- Homozygote.** An individual who possesses two identical alleles at one particular locus on a pair of homologous chromosomes.
- Homozygous.** The presence of two identical alleles at a particular locus on a pair of homologous chromosomes.
- Hormone nuclear receptors.** Intracellular receptors involved in the control of transcription.

- Housekeeping genes.** Genes that express proteins common to all cells (e.g., ribosomal, chromosomal, and cytoskeletal proteins).
- HTF islands.** Methylation-free clusters of CpG dinucleotides found near transcription initiation sites at the 5' end of many eukaryotic genes; can be detected by cutting with the restriction enzyme *HpaII*, producing tiny DNA fragments.
- Human Genome Project.** A major international collaborative effort to map and sequence the entire human genome.
- Human leukocyte antigen (HLA).** The HLA system is a gene cluster encoding the major histocompatibility complex (MHC) proteins in humans: cell-surface proteins responsible for the regulation of the immune system.
- Human Variome Project.** A global initiative to study and document human genomic variation across all population groups.
- Humoral immunity.** Immunity that is due to circulating antibodies in the blood and other bodily fluids.
- Huntingtin.** The protein product of the Huntington disease gene.
- H-Y antigen.** A histocompatibility antigen originally detected in the mouse and thought to be located on the Y chromosome.
- Hydatidiform mole.** An abnormal conceptus that consists of abnormal tissues. A complete mole contains no fetus, but can undergo malignant change and receives both sets of chromosomes from the father; a partial mole contains a chromosomally abnormal fetus with triploidy.
- Hydrops fetalis.** The most severe form of  $\alpha$ -thalassemia, resulting in death of the fetus in utero from heart failure secondary to the severe anemia caused by hemolysis of the red cells.
- Hypervariable DNA length polymorphisms.** Different types of variation in DNA sequence that are highly polymorphic (e.g., variable number tandem repeats, mini- and microsatellites).
- Hypervariable minisatellite DNA.** Highly polymorphic DNA consisting of a 9- to 24-bp sequence often located near the telomeres.
- Hypervariable region.** Small regions present in the variable regions of the light and heavy chains of antibodies in which the majority of the variability in antibody sequence occurs.
- Hypomorph.** Loss-of-function mutations that result in either reduced activity or complete loss of the gene product from either reduced activity or to decreased stability of the gene product.
- Identical twins.** See [Monozygotic twins](#).
- Iddiogram.** An idealized representation of an object (e.g., an idiogram of a karyotype).
- Idiotype.** In immunology, a shared characteristic between immunoglobulin or T cell receptor molecules, according to antigen binding specificity, and thus structure of their variable region.
- Immunoglobulin.** See [Antibody](#).
- Immunoglobulin allotypes.** Genetically determined variants of the various antibody classes (e.g., the Gm system associated with the heavy chain of IgG).
- Immunoglobulin superfamily.** The multigene families primarily involved in the immune response with structural and DNA sequence homology.
- Immunohistochemistry (IHC).** The technique of detecting antigens in a tissue section using specific antibodies.
- Immunological memory.** The ability of the immune system to 'remember' previous exposure to a foreign antigen or infectious agents, leading to the enhanced secondary immune response on re-exposure.
- Imprinting.** The phenomenon of a gene or region of a chromosome showing different expression depending on the parent of origin.
- Imputation.** In genetic studies, the concept of inferring genotypes or haplotypes in order to avoid full sequencing of all individual genomes.
- Inborn error of metabolism.** An inherited metabolic defect that results in deficient production or synthesis of an abnormal enzyme.
- Incest.** Union between first-degree relatives.
- Incestuous.** Description of a relationship between first-degree relatives.
- Incidence.** The rate at which new cases occur; for example, two in 1000 births are affected by neural tube defects.
- Incompatibility.** A donor and host are incompatible if the latter rejects a graft from the former.
- Incomplete ascertainment.** A term used in segregation analysis to describe family studies in which complete ascertainment is not possible.
- Index case.** See [Proband](#).
- Index map.** See [Framework map](#).
- Indian hedgehog.** One of three mammalian homologs of the segment polarity hedgehog genes.
- Induced pluripotent stem cell (iPSC).** A form of pluripotent stem cell that can be generated directly from adult cells.
- Inducer.** Small molecule that interacts with a regulator protein and triggers gene transcription.
- Informative.** Variation in a marker system in a family that enables a gene or inherited disease to be followed in that family.
- Innate immunity.** A number of non-specific systems involved in immunity that do not require or involve prior contact with the infectious agent.
- Insertion.** Addition of chromosomal material or DNA sequence of one or more nucleotides within the genome.
- Insertional mutagenesis.** The introduction of mutations at specific sites to determine the effects of these changes.
- In situ hybridization.** Hybridization with a DNA probe carried out directly on a chromosome preparation or histological section.
- Insulin-dependent diabetes mellitus.** Diabetes requiring the use of insulin, usually of juvenile onset, now known as type 1 diabetes.
- INS VNTR.** Refers to variable number of tandem repeats in the insulin gene.
- Interferon.** A type of cytokine signaling protein released by host cells in response to the presence of pathogens, e.g. viruses, bacteria, parasites, but also tumor cells.
- Intermediate inheritance.** See [Co-dominance](#).
- Interphase.** The stage between two successive cell divisions during which DNA replication occurs.
- Interphase cytogenetics.** The study of chromosomes during interphase, usually by FISH.
- Intersex.** An individual with external genitalia not clearly male or female.
- Interval cancer.** Developing cancer in the interval between repeated screening procedures.
- Intracellular signal transduction.** As part of cell signaling in general, the process whereby molecular events on the cell surface bring about change, e.g. nuclear gene expression.
- Intrachromosomal.** Usually referring to gene conversion events between different members of a gene family sited on the same chromosome.
- Intra-cytoplasmic sperm injection (ICSI).** A technique whereby a secondary spermatocyte or spermatozoon is removed from the testis and used to fertilize an egg.
- Intrinsic malformation.** A malformation resulting from an inherent abnormality in development.
- Intron (= intervening sequence).** Region of DNA that generates the part of precursor RNA that is spliced out during transcription and does not form mature mRNA and therefore does not specify the primary structure of the gene product.
- Inv.** Genetic variants of the  $\kappa$  light chains of immunoglobulins.
- Inversion.** A type of chromosomal aberration or mutation in which part of a chromosome or sequence of DNA is reversed in its order.

- Inversion loop.** The structure formed in meiosis I by a chromosome with either a paracentric or pericentric inversion.
- In vitro.** In the laboratory—literally ‘in glass.’
- In vitro fertilization (IVF).** The techniques to bring about penetration of an ovum by a sperm in the laboratory.
- In vivo.** In the normal cell—literally ‘in the living organism.’
- Ionizing radiation.** Electromagnetic waves of very short wavelength (X-rays and  $\gamma$ -rays), and high-energy particles ( $\alpha$  particles,  $\beta$  particles, and neutrons).
- Ion channelopathy.** A genetically determined abnormality of a pore-forming membrane protein which normally contributes to establishing a resting membrane potential.
- Ion semiconductor sequencing.** A method of DNA sequencing based on detecting hydrogen ions released during the polymerization of DNA.
- Isochromosome.** A type of chromosomal aberration in which one of the arms of a particular chromosome is duplicated because the centromere divides transversely and not longitudinally as normal during cell division. The two arms of an isochromosome are therefore of equal length and contain the same set of genes.
- Isolate.** A term used to describe a population or group of individuals that for religious, cultural, or geographical reasons has remained separate from other groups of people.
- Isotype.** Any of the related proteins or genes from a particular gene family.
- Isozymes.** Enzymes that exist in multiple molecular forms which can be distinguished by biochemical methods.
- Joining (J) region.** Short, conserved sequence of nucleotides involved in somatic recombinational events in the production of antibody diversity.
- Joint probability.** The product of the prior and conditional probability for two events.
- Junk DNA.** A loose term referring to the vast amount (proportionately) of non-coding DNA in the genome.
- Justice.** The principle in medical ethics of healthcare resources being equitably distributed.
- Karyogram.** Photomicrograph of chromosomes arranged in descending order of size.
- Karyotype.** The number, size, and shape of the chromosomes of an individual. Also used for the photomicrograph of an individual’s chromosomes arranged in a standard manner.
- Kb.** Abbreviation for kilobase.
- Killer lymphocytes.** See *Cytotoxic T lymphocytes*.
- Kilobase.** 1000 base pairs (bp).
- Km.** Genetic variants of the  $\kappa$  light chain of immunoglobulins.
- Knockout mutation.** Complete loss of function of a gene.
- Lagging strand.** One of the two strands created in DNA replication which is synthesized in the 3’ to 5’ direction made up of pieces synthesized in the 5’ to 3’ direction, which are then joined together as a continuous strand by the enzyme DNA ligase.
- Law of addition.** If two or more events are mutually exclusive then the probability that either one or the other will occur equals the sum of their individual probabilities.
- Law of independent assortment.** Members of different gene pairs segregate to offspring independently of one another.
- Law of multiplication.** If two or more events or outcomes are independent, the probability that both the first and the second will occur equals the product of their individual probabilities.
- Law of segregation.** Each individual possesses two genes for a particular characteristic, only one of which can be transmitted at any one time.
- Law of uniformity.** When two homozygotes with different alleles are crossed, all of the offspring in the F1 generation are identical and heterozygous (i.e., the characteristics do not blend and can reappear in later generations).
- Leading strand.** The synthesis of one of the DNA strands created in DNA replication; occurs in the 5’ to 3’ direction as a continuous process.
- Lethal mutation.** A mutation that leads to the premature death of an individual or organism.
- Leucine zipper.** A DNA-binding motif controlling gene expression.
- Liability.** A concept used in disorders that are determined multifactorially to take into account all possible causative factors.
- Library.** Set of cloned DNA fragments derived from a particular DNA source (e.g., a cDNA library from the transcript of particular tissue, or a genomic library.)
- Ligase.** Enzyme used to join DNA molecules.
- Ligation.** Formation of phosphodiester bonds to link two nucleic acid molecules.
- Limbal stem cell (LSC).** A stem cell located in the basal epithelial layer of the corneal limbus.
- Linkage.** Two loci situated close together on the same chromosome, the alleles at which are usually transmitted together in meiosis in gamete formation.
- Linkage disequilibrium.** The occurrence together of two or more alleles at closely linked loci more frequently than would be expected by chance.
- Linkage phase.** The arrangement of alleles that are transmitted together across generations.
- Liposomes.** Artificially prepared cell-like structures in which one or more bimolecular layers of phospholipid enclose one or more aqueous compartments, which can include proteins.
- Localization sequences.** Certain short amino acid sequences in newly synthesized proteins that result in their transport to specific cellular locations, such as the nucleus, or their secretion.
- Location score.** Diagrammatic representation of likelihood ratios used in multipoint linkage analysis.
- Locus.** The site of a gene on a chromosome.
- Locus control region (LCR).** A region near the  $\beta$ -like globin genes involved in the timing and tissue specificity of their expression in development.
- Locus heterogeneity.** The phenomenon of a disorder being due to mutations in more than one gene or locus.
- LOD score.** A mathematical score of the relative likelihood of two loci being linked.
- Long interspersed nuclear elements (LINEs).** 50,000 to 100,000 copies of a DNA sequence of approximately 6000 bp that occurs approximately once every 50 kb and encodes a reverse transcriptase.
- Long terminal repeat (LTR).** One of two long sections of double-stranded DNA synthesized by reverse transcriptase from the RNA of a retrovirus involved in regulating viral expression.
- Loss of constitutional heterozygosity (LOCH).** Loss of an allele inherited from a parent; frequently seen as evidence of a ‘second hit’ in tumorigenesis.
- Loss-of-function mutation.** Phenotypic features of a disorder due to reduced or absent activity of the gene.
- Loss of heterozygosity (LOH).** A chromosomal event that results in loss of one copy of a gene and the surrounding chromosomal region.
- Loss of imprinting (LOI).** In epigenetics, removal of the methylation of DNA, thus allowing gene expression.
- Low-copy repeats (LCRs).** Homologous sequences of DNA (more than 95% sequence identity) interspersed throughout the genome, predisposing to unequal recombination.
- Low-resolution mapping.** See *Chromosome mapping*.
- Lymphokines.** Glycoproteins released from T lymphocytes after contact with an antigen that act on other cells of the host immune system.
- Lyonization.** The process of inactivation of one of the X chromosomes in females, originally proposed by the geneticist Mary Lyon.
- Lysosome.** An intracellular membrane-bound organelle that acts as a waste disposal system by digesting unwanted materials.
- Major histocompatibility complex (MHC).** A multigene locus that codes for the histocompatibility antigens involved in organ transplantation.

- Malformation.** A primary structural defect of an organ or part of an organ that results from an inherent abnormality in development.
- Manifesting heterozygote or carrier.** The phenomenon of a female carrier for an X-linked disorder having symptoms or signs of that disorder due to non-random X-inactivation (e.g., muscular weakness in a carrier for Duchenne muscular dystrophy).
- Map unit.** See [Centimorgan](#).
- Marker.** A loose term used for a blood group, biochemical, or DNA polymorphism that, if shown to be linked to a disease locus of interest, can be used in presymptomatic diagnosis, determining carrier status and prenatal diagnosis.
- Marker chromosome.** A small, extra, structurally abnormal chromosome.
- Massively parallel sequencing.** High-throughput DNA sequencing based on the assembly of multiple fragment reads that overlap, using DNA synthesis as opposed to the separation of chain termination products.
- Maternal (matrilineal) inheritance.** Transmission of a disorder through females.
- Matrilineal inheritance.** See [Maternal inheritance](#).
- Maximum likelihood method.** The calculation of the LOD score for various values of the recombination fraction ( $\theta$ ) to determine the best estimate of the recombination fraction.
- Meconium ileus.** Blockage of the small bowel in the newborn period resulting from inspissated meconium, a presenting feature of cystic fibrosis.
- Meiosis.** The type of cell division that occurs in gamete formation with halving of the somatic number of chromosomes, with the result that each gamete is haploid.
- Meiotic drive.** Preferential transmission of one of a pair of alleles during meiosis.
- Membrane attack complex (MAC).** A structure formed on the surface of pathogenic bacterial cells as a result of the activation of the host's immune pathways.
- Mendelian inheritance.** Inheritance that follows the laws of segregation and independent assortment as proposed by Mendel.
- Merlin.** The protein product of the neurofibromatosis type II gene.
- Mesoderm.** One of the three layers of cells in the early embryo; from this layer is formed muscle, the pharyngeal arches, connective tissue, bone and cartilage, endothelium of blood vessels, red and white blood cells, and kidneys.
- Messenger RNA (mRNA).** A single-stranded molecule complementary to one of the strands of double-stranded DNA that is synthesized during transcription and transmits the genetic information in the DNA to the ribosomes for protein synthesis.
- Metabolic disorder.** An inherited disorder involving a biochemical pathway (i.e., an inborn error of metabolism).
- Metabolomics.** The scientific study of processes involving chemical metabolites.
- Metacentric.** Term used to describe chromosomes in which the centromere is central with both arms being of approximately equal length.
- Metaphase.** The stage of cell division at which the chromosomes line up on the equatorial plate and the nuclear membrane disappears.
- Metaphase spreads.** The preparation of chromosomes during the metaphase stage of mitosis in which they are condensed.
- Methemoglobin.** A hemoglobin molecule in which the iron is oxidized.
- Methylation.** The chemical imprint applied to certain DNA sequences in their passage through gametogenesis (applying to a small proportion of the human genome).
- Microarray-CGH.** Comparative genomic hybridization (CGH) based on the two-dimensional plating, on a chip, of thousands of short sequences of DNA.
- Microdeletion.** A small chromosomal deletion detectable by high-resolution prometaphase chromosomal analysis or FISH.
- Microdeletion syndrome.** The pattern of abnormalities caused by a chromosome microdeletion.
- Microsatellite DNA.** Polymorphic variation in DNA sequences resulting from a variable number of tandem repeats of the dinucleotide CA, trinucleotides, or tetranucleotides.
- Microsatellite instability (MSI).** The alteration of the size of microsatellite polymorphic markers compared with the constitutional markers of an individual with hereditary non-polyposis colorectal cancer from mutations in the genes for the mismatch repair enzymes.
- Microtubules.** Long cylindrical tubes composed of bundles of small filaments that are an important part of the cytoskeleton.
- Minichromosomes.** Artificially constructed chromosomes containing centromeric and telomeric elements that allow replication of foreign DNA as a separate entity.
- Minidystrophin.** A modified dystrophin gene in which a large amount of the gene has been deleted, but that still has relatively normal function.
- Minigene.** A construct of a gene with the majority of the sequence removed that still remains functional (e.g., a dystrophin minigene).
- Minisatellite.** Polymorphic variation in DNA sequences from a variable number of tandem repeats of a short DNA sequence.
- Mismatch repair.** A molecular system for recognizing and repairing erroneous insertions and deletions that may arise during DNA replication, and the repair of some forms of DNA damage.
- Mismatch repair genes.** Those genes which, when mutated, lead to defects in the efficiency of correcting DNA errors, typically associated with Lynch syndrome.
- Misense mutation.** A point mutation that results in a change in an amino acid-specifying codon.
- Missing heritability.** A term applied to the notion that single genetic variants cannot account for much of the heritability of diseases, behaviors, and various phenotypes.
- Mitochondria.** Minute structures situated within the cytoplasm that are concerned with cell respiration.
- Mitochondrial DNA (mtDNA).** Mitochondria possess their own genetic material that codes for enzymes involved in energy-yielding reactions, mutations of which are associated with certain diseases in humans.
- Mitochondrial inheritance.** Transmission of a mitochondrial trait exclusively through maternal relatives.
- Mitosis.** The type of cell division that occurs in replication of somatic cells.
- Mixoploidy.** The presence of cell lines with a different genetic constitution in an individual.
- Modifier gene.** Phenotypic variability from the consequence of interactions with other genes.
- Molecular genetics.** The science that studies the structure and function of genes, disease and biological inheritance at a molecular level.
- Monogenic.** Refers to a genetically determined condition or trait that is due to a DNA variant in a single gene.
- Monosomy.** Loss of one member of a homologous pair of chromosomes so that there is one less than the diploid number of chromosomes ( $2N - 1$ ).
- Monozygotic twins (= identical).** Type of twins derived from a single fertilized ovum.
- Morphogen.** A chemical or substance that determines a developmental process.
- Morphogenesis.** The evolution and development of form and shape.
- Morula.** The 12- to 16-cell stage of the early embryo at 3 days after conception.
- Mosaicism.** The presence of two or more cell lines in an individual or tissue, either at the chromosomal or gene level.

**mRNA splicing.** The excision of intervening non-coding sequences or introns in the primary mRNA resulting in the non-contiguous exons being spliced together to form a shorter mature mRNA before its transportation to the ribosomes in the cytoplasm for translation.

**Mucoviscidosis.** An older term used for cystic fibrosis.

**Multifactorial.** In genetics, causation that is not monogenic but may be due to multiple genetic variants +/- environmental influences.

**Multifactorial inheritance.** Inheritance controlled by many genes with small additive effects (polygenic) plus the effects of the environment.

**Multigene families.** Genes with functional and/or sequence similarity.

**Multiple alleles.** The existence of more than two alleles at a particular locus in a population.

**Multiple displacement amplification.** A non-PCR based DNA amplification technique that can rapidly amplify minute amounts of DNA, generating larger sized products than conventional PCR.

**Multiple myeloma.** A cancer of antibody-producing B cells that leads to the production of a single species of an antibody in large quantities.

**Multipoint linkage analysis.** Analysis of the segregation of alleles at a number of closely adjacent loci.

**Mutable.** In genetics, DNA that is capable of being altered.

**Mutagen.** Natural or artificial ionizing radiation, chemical or physical agents that can induce alterations in DNA.

**Mutant.** A gene that has undergone a change or mutation.

**Mutation.** A change in genetic material, either of a single gene or in the number or structure of the chromosomes. A mutation that occurs in the gametes is inherited; a mutation in the somatic cells (somatic mutation) is not inherited.

**Mutation rate.** The number of mutations at any one particular locus that occur per gamete per generation.

**Mutational heterogeneity.** The occurrence of more than one mutation in a particular single-gene disorder.

**Mutator genes.** The equivalent in yeast to the DNA proof-reading enzymes that cause hereditary non-polyposis colorectal cancer.

**Myeloma.** A tumor of the plasma or antibody-producing cells.

**Natural killer (NK) cells.** Large granular lymphocytes with carbohydrate-binding receptors on their cell surface that recognize high molecular weight glycoproteins expressed on the cell surface of the infected cell as a result of the virus taking over the cellular replicative functions.

**Neural crest.** Transient group of cells in vertebrate development arising from the embryonic ectoderm, eventually giving rise to melanocytes, craniofacial cartilage and bone, smooth muscle, and some nerve cells.

**Neurocristopathy.** A pathology arising from a defect in the cells and tissues derived from the neural crest.

**Neurofibromin.** The protein product of the neurofibromatosis type I gene.

**Neutral gene.** A gene that appears to have no obvious effect on the likelihood of an individual's ability to survive.

**Neutropenias.** Any condition with an abnormally low number of white blood cells.

**New mutation.** The occurrence of a change in a gene arising as a new event.

**Next generation sequencing (NGS).** High-throughput DNA sequencing technologies that facilitate rapid whole genome or whole exome analysis.

**Nonconservative substitution.** A mutation that codes for an amino acid which is chemically dissimilar (e.g., a different charge) will result in a protein with an altered structure.

**Non-disjunction.** The failure of two members of a homologous chromosome pair to separate during cell division so that both pass to the same daughter cell.

**Non-identical twins.** See [Dizygotic twins](#).

**Non-insulin-dependent diabetes mellitus.** Diabetes that can often be treated with diet and/or oral medication, now known as type 2 diabetes.

**Non-maleficence.** The principle in medical ethics of 'first do no harm' (*primum non nocere*).

**Non-maternity.** The biological mother is not as stated or believed.

**Non-paternity.** The biological father is not as stated or believed.

**Non-penetrance.** The occurrence of an individual being heterozygous for an autosomal dominant gene but showing no signs of it.

**Non-random mating.** See [Assortative mating](#).

**Nonsense-mediated decay (NMD).** A pathway in eukaryotes that functions to reduce errors in gene expression by eliminating mRNA transcripts that contain premature stop codons.

**Nonsense mutation.** A mutation that results in one of the termination codons, thereby leading to premature termination of translation of a protein.

**Non-synonymous mutation.** A mutation that leads to an alteration in the encoded polypeptide.

**Normal allele.** The non-mutated version of a gene or DNA sequence of interest.

**Northern blotting.** Electrophoretic separation of mRNA with subsequent transfer to a filter and localization with a radiolabeled probe.

**Nuchal translucency.** Refers to an assessment of the quantity of fluid collecting within the nape of the fetal neck, usually from an ultrasound scan around the end of the first trimester.

**Nuclear envelope.** The membrane around the nucleus, separating it from the cytoplasm.

**Nuclear pores.** Gaps in the nuclear envelope that allow substances to pass from the nucleus to the cytoplasm and vice versa.

**Nucleolus.** A structure within the nucleus that contains high levels of RNA.

**Nucleosome.** DNA-histone subunit of a chromosome.

**Nucleotide.** Nucleic acid is made up of many nucleotides, each of which consists of a nitrogenous base, a pentose sugar and a phosphate group.

**Nucleotide excision repair.** One of three excision repair pathways to repair single stranded DNA, particularly from damage caused by ultraviolet light.

**Nucleus.** A structure within the cell that contains the chromosomes and nucleolus.

**Null allele.** See [Amorph](#).

**Nullisomy.** Loss of both members of a homologous pair of chromosomes.

**Obligate carrier.** An individual who, by pedigree analysis, must carry a particular gene (e.g., parents of a child with an autosomal recessive disorder).

**Odds ratio (OR).** A statistical way to quantify the strength of association of a property or characteristic; an OR of 1 means equal likelihood.

**Oligogene.** One of a relatively small number of genes that contribute to a disease phenotype.

**Oligogenic.** Pertaining to causation by a small number of gene variants.

**Oligonucleotide.** A chain of, literally, a few nucleotides.

**Oncogene.** A gene affecting cell growth or development that can cause cancer.

**Oncogenic.** Literally, 'cancer causing.'

**One gene-one enzyme (or protein).** The concept that each gene is the blueprint for a single enzyme, which in turn affects a single step in a metabolic pathway – now recognized to be an oversimplification.

**Opsonization.** The 'making ready' of an infectious agent in the production of an immune response.

**Origins of replication.** The points at which DNA replication commences.

**Orthologous.** Conserved genes or sequences between species.

**Ova.** Mature haploid female gametes.



- Oz.** The group of genetic variants of the  $\lambda$  light-chain immunoglobulins.
- P1-derived artificial chromosomes (PACs).** Combination of the P1- and F-factor systems to incorporate foreign DNA inserts up to 150 kb.
- Pachytene quadrivalent.** The arrangement adopted by the two pairs of chromosomes involved in a reciprocal translocation when undergoing segregation in meiosis I.
- Packaging cell line.** A cell line that has been infected with a retrovirus in which the provirus is genetically engineered to lack the packaging sequence of the proviral DNA necessary to produce infectious viruses.
- Packaging sequence.** The DNA sequence of the proviral DNA of a retrovirus necessary for packaging of the retroviral RNA into an infectious virus.
- Paint.** Use of fluorescently labeled probes derived from a chromosome or region of a chromosome to hybridize with a chromosome in a metaphase spread.
- Pair-rule mutant.** Developmental genes identified in *Drosophila* that cause pattern deletions in alternating segments.
- Panmixis.** See [Random mating](#).
- Paracentric inversion.** A chromosomal inversion that does not include the centromere.
- Paralogous.** Close resemblance of genes from different clusters (e.g., *HOXA13* and *HOXD13*).
- Paraprotein.** An abnormal immunoglobulin (Ig) fragment or Ig light chain produced in excess by an aberrant monoclonal proliferation of plasma cells.
- Parthenogenesis.** The development of an organism from an unfertilized oocyte.
- Partial sex-linkage.** A term used to describe genes on the homologous or pseudoautosomal portion of the X and Y chromosomes.
- Penetrance.** The proportion of heterozygotes for a dominant gene who express a trait, even if mildly.
- Peptide.** An amino acid, a portion of a protein.
- Pericentric inversion.** A chromosomal inversion that includes the centromere.
- Peroxisome.** An intracellular organelle found in nearly all eukaryotes, involved in catabolism of very long chain fatty acids, among other chemicals.
- Permissible dose.** An arbitrary safety limit that is probably much lower than that which would cause any significant effect on the frequency of harmful mutations within the population.
- Phage.** Abbreviation for bacteriophage.
- Pharmacodynamics.** The study of the biochemical and physiologic effects of (mainly) pharmaceutically produced drugs.
- Pharmacogenetics.** The study of inherited genetic differences in drug metabolism, which can affect individual drug responsiveness.
- Pharmacogenomics.** Similar to Pharmacogenetics: the study of the role of the genome in drug responsiveness and the difference between individuals.
- Pharmacokinetics.** Similar to Pharmacodynamics: the study of the fate of drugs and substances administered to a living organism.
- Phase.** The relation of two or more alleles (DNA 'markers') at two linked genetic loci. If the alleles are located on the same physical chromosome they are 'in phase,' or 'coupled.'
- Phenocopy.** A condition that is due to environmental factors but resembles one that is genetic.
- Phenol-enhanced reassociation technique (pERT).** Use of the chemical phenol to facilitate rehybridization of slightly differing sources of double-stranded DNA to enable isolation of sequences that are absent from one of the two sources.
- Phenotype.** The appearance (physical, biochemical, and physiological) of an individual that results from the interaction of the environment and the genotype.
- Philadelphia chromosome (Ph1).** The shortened form of chromosome 22 arising from a translocation and containing a fusion gene called *BCR-ABL1*, seen particularly in chronic myeloid leukemia.
- PI type.** Abbreviation of 'protease inhibitor' type, relating to alpha-1 antitrypsin deficiency.
- Pink-eyed dilution.** Human homolog to mouse pink-eye gene for albinism.
- Plasma cells.** Mature antibody-producing B lymphocytes.
- Plasmid.** Small, circular DNA duplex capable of autonomous replication within a bacterium.
- Platelet-derived growth factor (PDGF).** A substance derived from platelets that stimulates the growth of certain cell types.
- Pleiotropy.** The multiple effects of a gene.
- Plexiform.** Relating to, or resembling, a plexus; most often used in relation to a large and/or deep seated neurofibroma.
- Point mutation.** A single nucleotide base substitution, insertion, or deletion in DNA ('mutation' implies pathogenic, usually in a coding region of a gene).
- Polar body.** The daughter cell of gamete division in the female in meiosis I and II that does not go on to become a mature gamete.
- Polarity.** In *biochemistry*, refers to molecules demonstrating a separation of positive and negative electrical charges within their structure. In *developmental biology*, refers to the establishment of an axis in early structures.
- Polyadenylation signal mutation.** A mutation affecting a poly(A) sequence which has a signaling function.
- Poly(A) tail.** A sequence of 20 to 200 adenylic acid residues that is added to the 3' end of most eukaryotic mRNAs, increasing its stability by making it resistant to nuclease digestion.
- Polygenes.** Genes that make a small additive contribution to a polygenic trait.
- Polygenic inheritance.** The genetic contribution to the etiology of disorders in which there are both environmental and genetic causative factors.
- Polymerase chain reaction (PCR).** The repeated serial reaction involving the use of oligonucleotide primers and DNA polymerase that is used to amplify a particular DNA sequence of interest.
- Polymorphic information content (PIC).** The amount of variation at a particular site in the DNA.
- Polymorphism.** The occurrence in a population of two or more genetically determined forms in such frequencies that the rarest of them could not be maintained by mutation alone.
- Polypeptide.** An organic compound consisting of three or more amino acids.
- Polyploid.** Any multiple of the haploid number of chromosomes (3N, 4N, etc.).
- Polyribosome.** See [Polysome](#).
- Polysome (= polyribosome).** A group of ribosomes associated with the same molecule of mRNA.
- Population genetics.** The study of the distribution of alleles in populations.
- Positional candidate gene.** A gene located within a chromosome region believed to harbor the gene responsible for a disease or phenotype under study. It is a candidate because it is positioned within the critical chromosomal region.
- Positional cloning.** The mapping of a disorder to a particular region of a chromosome and leading to identification of the gene responsible.
- Positive predictive value.** In statistics, the number of true positives divided by the total number of positive results (the latter includes false positives).
- Posterior information.** Information available for risk calculation from the results of tests or analysis of offspring in pedigrees.
- Posterior probability.** The joint probability for a particular event divided by the sum of all possible joint probabilities.
- Post-genomic genomics.** See [Functional genomics](#).
- Postreplication repair.** Repair to damaged DNA that takes place after replication.

- Post-translational modification (or processing).** The modification of polypeptide chains into mature proteins that occurs after their synthesis by ribosomal translation of mRNA.
- Precision medicine.** The use of pharmacogenetics or genomics to deliver tailor-made treatments, e.g. in cancer; an alternative term to personalized medicine.
- Predictive testing.** Presymptomatic testing, e.g. in relation to testing of people at risk for Huntington disease.
- Preimplantation genetic diagnosis.** The ability to detect the presence of an inherited disorder in an in-vitro fertilized conceptus before reimplantation.
- Preimplantation genetic haplotyping.** The use of linked markers (rather than mutation analysis) to determine the genetic status of the early embryo in preimplantation genetic diagnosis.
- Premutation.** The existence of a gene in an unstable form that can undergo a further mutational event to cause a disease.
- Prenatal diagnosis.** The use of tests during a pregnancy to determine whether an unborn child is affected by a particular disorder.
- Presymptomatic.** In genetic disease with a late age of onset (i.e. not congenital, usually adult onset), the period before symptoms and signs of the disorder are present.
- Presymptomatic diagnosis.** The use of tests to determine whether a person has inherited a gene for a disorder before he or she has any symptoms or signs.
- Presymptomatic testing.** An alternative term for Predictive testing.
- Prevalence.** At a point in time, the proportion of people in a given population with a disorder or trait.
- Primary response.** The response to an infectious agent with an initial production of IgM, then subsequently IgG.
- Prion.** A proteinaceous infectious particle implicated in the cause of several rare neurodegenerative diseases.
- Prior probability.** The initial probability of an event.
- Probability.** The proportion of times an outcome occurs in a large series of events.
- Proband (= index case).** An affected individual (irrespective of sex) through whom a family comes to the attention of an investigator. Propositus if male; propoita if female.
- Probe.** A labeled, single-stranded DNA fragment that hybridizes with, and thereby detects and locates, complementary sequences among DNA fragments on, for example, a nitrocellulose filter.
- Processing.** Alterations of mRNA that occur during transcription including splicing, capping, and polyadenylation.
- Progress zone.** The area of growth beneath the apical ectodermal ridge in the developing limb bud.
- Prokaryotes.** Lower organisms with no well-defined nucleus (e.g., bacteria).
- Prometaphase.** The stage of cell division when the nuclear membrane begins to disintegrate, allowing the chromosomes to spread, with each chromosome attached at its centromere to a microtubule of the mitotic spindle.
- Promoter.** Recognition sequence for the binding of RNA polymerase.
- Promoter elements.** DNA sequences that include the GGGCGG consensus sequence, the AT-rich TATA or Hogness box, and the CAAT box, in a 100- to 300-bp region located 5' or upstream to the coding sequence of many structural genes in eukaryotic organisms and which control individual gene expression.
- Pronuclei.** The stage just after fertilization of the oocyte with the nucleus of the oocyte and sperm present.
- Prophase.** The first visible stage of cell division when the chromosomes are contracted.
- Propoita.** A female individual as the presenting person in a family.
- Propositus.** A male individual as the presenting person in a family.
- Protein.** A complex organic compound composed of hundreds or thousands of amino acids.
- Proteomics.** The large scale of an organism's proteins (term first coined in 1997).
- Proto-oncogene.** A gene that can be converted to an oncogene by an activating mutation. The term 'oncogene' is now commonly used for both the normal and activated gene forms. The DNA genomic sequence shows homology to viral oncogenes.
- Pseudoautosomal.** Genes that behave like autosomal genes as a result of being located on the homologous portions of the X and Y chromosomes.
- Pseudodominance.** The apparent dominant transmission of a disorder when an individual homozygous for a recessive gene has affected offspring through having children with an individual who is also a carrier.
- Pseudogene.** DNA sequence homologous with a known gene but non-functional.
- Pseudohermaphrodite.** An individual with ambiguous genitalia or external genitalia opposite to the chromosomal sex in which there is gonadal tissue of only one type.
- Pseudohypertrophy.** Literally, false enlargement. Seen in the calf muscles of boys with Duchenne muscular dystrophy.
- Pseudomosaicism.** False mosaicism seen occasionally as an artifact with cells in culture.
- Pulsed-field gel electrophoresis (PFGE).** A technique of DNA analysis using electrophoretic methods to separate large DNA fragments, up to 2 million base pairs in size, produced by digesting DNA with restriction enzymes with relatively long DNA recognition sequences that, as a consequence, cut DNA relatively infrequently.
- Purine.** A nitrogenous base with fused five- and six-member rings (adenine and guanine).
- Pyrimidine.** A nitrogenous base with a six-membered ring (cytosine, uracil, thymine).
- Quantitative inheritance.** See [Polygenic inheritance](#).
- Radiation absorbed dose (rad).** A measure of the amount of any ionizing radiation that is absorbed by the tissues; 1 rad is equivalent to 100 erg of energy absorbed per gram of tissue.
- Radiation hybrid.** An abnormal cell containing numerous small fragments of human chromosomes, brought about by fusion with a lethally irradiated human cell. These cells have a very useful role in physical gene mapping.
- Random genetic drift.** The chance variation of allele frequencies from one generation to the next.
- Random mating (= panmixis).** Selection of a spouse regardless of the spouse's genotype.
- Reading frame.** The order of the triplets of nucleotides in the codons of a gene that are translated into the amino acids of the protein.
- Recessive.** A trait expressed in individuals who are homozygous for a particular allele but not in those who are heterozygous.
- Reciprocal translocation.** A structural rearrangement of the chromosomes in which material is exchanged between one homolog of each of two pairs of chromosomes. The rearrangement is balanced if there is no loss or gain of chromosome material.
- Recombinant DNA molecule.** A union of two different DNA sequences from two different sources (e.g., a vector containing a 'foreign' DNA sequence).
- Recombination.** Cross-over between two linked loci.
- Recombination fraction ( $\theta$ ).** A measure of the distance separating two loci determined by the likelihood that a crossover will occur between them.
- Reduced penetrance.** A dominant gene or allele that is not manifested in a proportion of heterozygotes.
- Regression coefficient.** In data presented graphically as a linear relationship, this coefficient is the constant that represents the rate of change of one variable as a function of changes in the other, i.e. it is the slope of the regression line.

- Regression to the mean.** In statistics, the phenomenon that a variable that is extreme on first measurement will tend to be closer to the average on the second measurement – and if extreme on the second measurement is likely to have been closer to the average on the first.
- Regulome.** Refers to the entire set of regulatory components in a cell and their interplay, including their dependence on variables.
- Relative.** The connection of one person with another by circumstances of birth.
- Relative probability.** See [Posterior probability](#).
- Relative risk.** The frequency with which a disease occurs in an individual with a specific marker compared with that in those without the marker in the general population.
- Repetitive DNA.** DNA sequences of variable length that are repeated up to 100,000 (middle repetitive) or more than 100,000 (highly repetitive) copies per genome.
- Replication.** The process of copying the double-stranded DNA of the chromosomes.
- Replication bubble.** The structure formed by coalescence of two adjacent replication forks in copying the DNA molecule of a chromosome.
- Replication error.** The phenomenon of microsatellite instability seen in hereditary non-polyposis colorectal cancer from a mutation in one of the DNA proof-reading enzymes.
- Replication fork.** The structure formed at the site(s) of origin of replication of the double-stranded DNA molecule of chromosomes.
- Replication units.** Clusters of 20 to 80 sites of origin of DNA replication.
- Replicons.** A generic term for DNA vectors such as plasmids, phages, and cosmids that replicate in host bacterial cells.
- Repressor.** The product of the regulator gene of an operon that inhibits the operator gene.
- Repulsion.** When a particular allele at a locus is on the homologous chromosome for a specific allele at a closely linked locus.
- Repurposing.** The process whereby any entity with one intended use is transformed or redeployed as something with an alternative use.
- Response elements.** Regulatory sequences in the DNA to which signaling molecules bind, resulting in control of transcription.
- Restriction endonucleases or enzymes.** Group of enzymes each of which cleaves double-stranded DNA at a specific nucleotide sequence and so produces fragments of DNA of different lengths.
- Restriction enzyme.** An enzyme (a protein-endonuclease) that has the property to cut DNA at or near a specific recognition nucleotide sequence (restriction site).
- Restriction fragment.** DNA fragment produced by a restriction endonuclease.
- Restriction fragment length polymorphism (RFLP).** Polymorphism resulting from the presence or absence of a particular restriction site.
- Restriction map.** Linear arrangement of restriction enzyme sites.
- Restriction site.** Base sequence recognized by a restriction endonuclease.
- Reticulocytes.** Immature red blood cells that still contain mRNA.
- Retrovirus.** A virus that uses its own reverse transcriptase to produce DNA in a host cell from its RNA genome (i.e., the reverse of the usual pattern); the host cell then treats the viral DNA as part of its own genome.
- Reverse genetics.** The process of identifying a protein or enzyme through its gene product.
- Reverse painting.** Amplification using PCR of an unidentified portion of chromosomal material, such as a small duplication or marker chromosome, which is then used as a probe for hybridization to a normal metaphase spread to identify its source of origin.
- Reverse transcriptase.** An enzyme that catalyzes the synthesis of DNA from RNA.
- Reverse transcriptase-PCR (RT-PCR).** Using a special primer that contains a promoter and translation initiator from mRNA (for PCR) to make cDNA.
- Ribonucleic acid (RNA).** See [RNA](#).
- Ribosomal RNA (rRNA).** The RNA component of ribosomes, essential for protein synthesis.
- Ribosomes.** Minute spherical structures in the cytoplasm, rich in RNA; the location of protein synthesis.
- Ring chromosome.** An abnormal chromosome caused by a break in both arms of the chromosome, the ends of which unite leading to the formation of a ring.
- RNA (= ribonucleic acid).** The nucleic acid found mainly in the nucleolus and ribosomes. Messenger RNA transfers genetic information from the nucleus to the ribosomes in the cytoplasm and also acts as a template for the synthesis of polypeptides.
- RNA-directed DNA synthesis.** An exception to the central dogma—a process used by many RNA viruses to produce DNA that can integrate with the host genome.
- RNA modification mutation.** A DNA variant in a nuclear gene that results in modulating the phenotypic manifestation of an RNA mutation.
- Robertsonian translocation.** A translocation between two acrocentric chromosomes with loss of satellite material from their short arms.
- Roentgen equivalent for man (rem).** The dose of any radiation that has the same biological effect as 1 rad of X-rays.
- Sanger sequencing.** Developed by Fred Sanger in 1997, a DNA sequencing technique based on the selective incorporation of chain-terminating dideoxynucleotides by DNA polymerase during in vitro DNA replication.
- Satellite.** A distal portion of the chromosome separated from the remainder of the chromosome by a narrowed segment or stalk.
- Satellite DNA.** A class of DNA sequences that separates out on density gradient centrifugation as a shoulder or ‘satellite’ to the main peak of DNA and corresponds to 10% to 15% of the DNA of the human genome, consisting of short, tandemly repeated, DNA sequences that code for ribosomal and transfer RNAs.
- Screening.** The identification of people from a population with a particular disorder, or who carry a gene for a particular disorder.
- Secondary hypertension.** Increased blood pressure that occurs as a result of another primary cause.
- Secondary oocyte or spermatocyte.** The intermediate stage of a female or male gamete in which the homologous duplicated chromosome pairs have separated.
- Secondary response.** The enhanced immune response seen after repeated exposure to an infectious organism or foreign antigen.
- Secretor locus.** A gene in humans that results in the secretion of the ABO blood group antigens in saliva and other body fluids.
- Secretor status.** The presence or absence of excretion of the ABO blood group antigens into various body fluids (e.g., saliva).
- Segment polarity mutants.** Developmental genes identified in *Drosophila* that cause pattern deletions in every segment.
- Segmental.** Limited area of involvement (e.g., a somatic mutation limited to one area of embryonic development).
- Segregation.** The separation of alleles during meiosis so that each gamete contains only one member of each pair of alleles.
- Segregation analysis.** Study of the way in which a disorder is transmitted in families to establish the mode of inheritance.
- Segregation ratio.** The proportion of affected to unaffected individuals in family studies.
- Selection.** The forces that affect biological fitness and therefore the frequency of a particular condition within a given population.
- Selfish DNA.** DNA sequences that appear to have little function and that, it has been proposed, preserve themselves as a result of selection within the genome.
- Semi-conservative.** The process in DNA replication by which only one strand of each resultant daughter molecule is newly synthesized.

- Sense strand.** Strand of genomic DNA to which the mRNA is identical.
- Sensitivity.** Refers to the proportion of cases that are detected. A measure of sensitivity can be made by determining the proportion of false-negative results (i.e., how many cases are missed).
- Septic shock.** The serious medical state whereby infection, usually bacterial, leads to widespread cellular dysfunction and organ damage.
- Sequence.** A stretch of DNA nucleotides. Also used in relation to birth defects or congenital abnormalities that occur as a consequence of a cascade of events initiated by a single primary factor (e.g., Potter's sequence, which occurs as a consequence of renal agenesis).
- Sequencing.** The process of determining the order of nucleotides of a given DNA fragment.
- Sequencing by synthesis.** A sequencing method based on reversible dye-terminators that enable the identification of single bases as they are introduced into DNA strands; the technology facilitates massively parallel sequencing.
- Severe combined immunodeficiency.** A genetically heterogeneous lethal form of inherited immunodeficiency with abnormal B- and T-cell function leading to increased susceptibility to both viral and bacterial infections.
- Sex chromatin (= Barr body).** A darkly staining mass situated at the periphery of the nucleus during interphase which represents a single, inactive, condensed X chromosome. The number of sex chromatin masses is one less than the number of X chromosomes (e.g., none in normal males and 45,X females, one in normal females and XXY males).
- Sex chromosomes.** The chromosomes responsible for sex determination (XX in women, XY in men).
- Sex-determining region of the Y (SRY).** The part of the Y chromosome that contains the testis-determining gene.
- Sex influence.** When a genetic trait is expressed more frequently in one sex than another. In the extreme, when only one sex is affected, this is called sex limitation.
- Sex limitation.** When a trait is manifest only in individuals of one sex.
- Sex linkage.** The pattern of inheritance shown by genes carried on the sex chromosomes. Because there are very few Mendelizing genes on the Y chromosome, the term is often used synonymously for X-linkage.
- Sex-linked inheritance.** A disorder determined by a gene on one of the sex chromosomes.
- Sex ratio.** The number of male births divided by the number of female births.
- Short interspersed nuclear elements (SINEs).** Five percent of the human genome consists of some 750,000 copies of DNA sequences of approximately 300 bp that have sequence similarity to a signal recognition particle involved in protein synthesis.
- Siamese twins.** Conjoined identical twins.
- Sib (= sibling).** Brother or sister.
- Sibship.** A group of offspring having the same two parents.
- Sickle cell crisis.** An acute hemolytic episode in people with sickle cell disease associated with a sudden onset of chest, back or limb pain, fever and dark urine from the presence of free hemoglobin in the urine.
- Sickle cell disease.** The homozygous state for hemoglobin S associated with anemia and the risk of sickle cell crises.
- Sickle cell trait.** The heterozygous state for hemoglobin S which is not associated with any significant medical risks under ordinary conditions.
- Sickling.** The process of distortion of red blood cell morphology under low oxygenation conditions in people with sickle cell disease.
- Sievert (Sv).** Equivalent to 100 rem.
- Signal transduction.** A complex multistep pathway from the cell membrane, through the cytoplasm to the nucleus, with positive and negative feedback loops for accurate cell proliferation and differentiation.
- Silencers.** A negative 'enhancer,' the normal action of which is to repress gene expression.
- Silent mutation.** A point mutation in a codon that, because of the degeneracy of the genetic code, still results in the same amino acid in the protein.
- Single-nucleotide polymorphisms (SNPs).** Single-nucleotide DNA sequence variation that is polymorphic, occurring every 1/500 to 1/2000 base pairs.
- Single-stranded conformational polymorphism (SSCP).** A mutation detection system in which differences in the three-dimensional structure of single-stranded DNA result in differential gel electrophoresis mobility under special conditions.
- Sister chromatids.** Identical daughter chromatids derived from a single chromosome.
- Sister chromatid exchange (SCE).** Exchange (crossing over) of genetic material between two chromatids of any particular chromosome in mitosis.
- Site-directed mutagenesis.** The ability to alter or modify DNA sequences or genes in a directed fashion by processes such as insertional mutagenesis or homologous recombination to determine the effect of these changes on their function.
- Skeleton map.** See [Framework map](#).
- Skewed X-inactivation.** A non-random pattern of inactivation of one of the X chromosomes in a female that can arise through a variety of mechanisms (e.g., an X-autosome translocation).
- Slippage.** A type of mutation leading to either a trinucleotide or dinucleotide expansion, or contraction, during DNA replication.
- Slipped strand mispairing.** Incorrect pairing of the tandem repeats of the two complementary DNA strands during DNA replication that is thought to lead to variation in DNA microsatellite repeat number.
- Small nuclear RNA molecules.** RNA molecules involved in RNA splicing.
- Soft markers.** Minor structural ultrasound findings associated with the possibility of fetal abnormality.
- Solenoid model.** The complex model of the quaternary structure of chromosomes.
- Somatic.** Pertaining to body cells (as opposed to germ cells).
- Somatic cell gene therapy.** The alteration or replacement of a gene limited to the non-germ cells.
- Somatic cell hybrid.** A technique involving the fusion of cells from two different species that results in the loss of chromosomes from one of the cell types and is used in assigning genes to particular chromosomes.
- Somatic cells.** The non-germline cells of the body.
- Somatic mosaicism.** The occurrence of two different cell lines in a particular tissue or tissues that differ genetically.
- Somatic mutation.** A mutation limited to the non-germ cells.
- Sonic hedgehog.** One of three mammalian homologs of the segment polarity hedgehog genes.
- Southern blot.** Technique for transferring DNA fragments from an agarose gel to a nitrocellulose filter on which they can be hybridized to a radiolabeled single-stranded complementary DNA sequence or probe.
- Specific acquired or adaptive immunity.** A tailor-made immune response that occurs after exposure to an infectious agent.
- Specificity.** The extent to which a test detects only affected individuals. If unaffected people are detected, these are referred to as false positives.
- Spermatid.** Mature haploid male gamete.
- Spindle.** A structure responsible for the movement of the chromosomes during cell division.
- Splicing.** The removal of the introns and joining of exons in RNA during transcription, with introns being spliced out and exons being spliced together.

- Splicing branch site.** Intronic sequence involved in splicing of mRNA.
- Splicing consensus sequences.** DNA sequences surrounding splice sites.
- Spontaneous mutation.** A mutation that arises de novo, apparently not from environmental factors such as mutagens.
- Sporadic.** When a disorder affects a single individual in a family.
- Stable mutation.** A mutation that is transmitted unchanged.
- Stop codons.** One of three codons (UAG, UAA, and UGA) that cause termination of protein synthesis.
- Stratified medicine.** In genetics/genomics, the process of separating patients into groups according to their risk or predicted response to treatment; similar to personalized or precision medicine.
- Subchromosomal mapping.** Mapping of a gene or DNA sequence of interest to a region of a chromosome.
- Submetacentric.** Chromosomes in which the centromere is slightly off center.
- Substitution.** A single base pair replaced by another nucleotide.
- Suppressor lymphocytes.** A subclass of T lymphocytes that regulate immune responses, particularly suppressing an immune response to 'self'.
- Switching.** Change in the type of  $\beta$ - or  $\alpha$ -like globin chains produced in embryonic and fetal development.
- Synapsis.** The pairing of homologous chromosomes during meiosis.
- Synaptonemal complex.** A complex protein structure that forms between two homologous chromosomes which pair during meiosis.
- Syndrome.** The complex of symptoms and signs that occur together in any particular disorder.
- Synonymous mutation.** See [Silent mutation](#).
- Syntenic genes.** Two genes at different loci on the same chromosome.
- Syntenic.** The comparison of two sets of chromosomes and their conserved blocks of DNA sequence (across species).
- T.** Abbreviation for thymine.
- TATA (Hogness) box.** See [Hogness box](#).
- T cell.** Also T lymphocyte: a type of lymphocyte that matures in the thymus gland, with a T-cell receptor on its surface.
- T-cell surface antigen receptor.** Antigenic receptor on the cell surface of T lymphocytes.
- T helper cell.** A cell that aids the activity of other immune cells by releasing T cell cytokines helping to suppress or regulate immune responses.
- Tandemly repeated DNA sequences.** DNA consisting of blocks of tandem repeats of non-coding DNA that can be either highly dispersed or restricted in their location in the genome.
- Target DNA.** The carrier or vector DNA to which foreign DNA is incorporated or attached to produce recombinant DNA.
- Telomere.** The distal portion of a chromosome arm.
- Telomeric DNA.** The terminal portion of the telomeres of the chromosomes contains 10 to 15 kb of tandem repeats of a 6 base-pair DNA sequence.
- Telophase.** The stage of cell division when the chromosomes have separated completely into two groups and each group has become invested in a nuclear membrane.
- Template strand.** The strand of the DNA double helix that is transcribed into mRNA.
- Teratogen.** An agent that causes congenital abnormalities in the developing embryo or fetus.
- Teratogene.** A gene that can mutate to form a developmental abnormality.
- Termination codon.** See [Stop codons](#).
- Terminator.** A sequence of nucleotides in DNA that codes for the termination of translation of mRNA.
- Tertiary trisomy.** The outcome when three to one segregation of a balanced reciprocal translocation results in the presence of an additional derivative chromosome.
- Tetraploidy.** Twice the normal diploid number of chromosomes (4N).
- Thalassemia intermedia.** A less severe form of  $\beta$ -thalassemia that requires less frequent transfusions.
- Thalassemia major.** An inherited disorder of human hemoglobin that is due to underproduction of one of the globin chains.
- Thalassemia minor.** See [Thalassemia trait](#).
- Thalassemia trait.** The heterozygous state for  $\beta$ -thalassemia, associated with an asymptomatic, mild, microcytic, hypochromic anemia.
- Thousand genomes project.** An international research collaboration launched in 2008 to establish the most detailed catalogue of human genetic variation (at that time).
- Three-prime (3') end.** The end of a DNA or RNA strand with a free 3' hydroxyl group.
- Threshold.** A concept used in disorders that exhibit multifactorial inheritance to explain a discontinuous phenotype in a process or trait that is continuous (e.g., cleft lip as a result of disturbances in the process of facial development).
- Thymine.** A pyrimidine base in DNA.
- Tissue typing.** Cellular, serological and DNA testing to determine histocompatibility for organ transplantation.
- Toll-like receptor (TLR).** A membrane-spanning protein that plays a key role in the innate immune system, recognizing microbial conserved molecules.
- Trait.** Any detectable phenotypic property or character.
- Trans-acting.** Transcription factors that act on genes at a distance, usually on both copies of a gene on each chromosome.
- Transcription.** The process whereby genetic information is transmitted from the DNA in the chromosomes to mRNA.
- Transcription factors.** Genes, including the *Hox*, *Pax*, and zinc finger-containing genes, that control RNA transcription by binding to specific DNA regulatory sequences and forming complexes that initiate transcription by RNA polymerase.
- Transcription mutation.** A DNA variant that occurs within a transcription factor, and thus affects gene expression.
- Transcriptomics.** The study of all messenger RNA molecules in a cell or population of cells.
- Transformation.** The transformation of bacterial cells by infection with phage to produce infectious phage particles. Also the introduction of foreign DNA into eukaryotic cells in culture.
- Transfer RNA (tRNA).** RNA molecule involved in transfer of amino acids in the process of translation.
- Transformation.** Genetic recombination in bacteria in which foreign DNA introduced into the bacterium is incorporated into the chromosome of the recipient bacterium. Also the change of a normal cell into a malignant cell; for example, as results from infection of normal cells by oncogenic viruses.
- Transforming principle.** The observation, through experiments in the 1920s, that bacteria are capable of transferring genetic information, which led to the discovery that DNA is the chemical of inheritance.
- Transgenic animal model.** Use of techniques such as targeted gene replacement to introduce mutations into a particular gene in another animal species to study an inherited disorder in humans.
- Transient polymorphism.** Two different allelic variants present in a population whose relative frequencies are altering due to either selective advantage or disadvantage of one or the other.
- Transition.** A substitution involving replacement by the same type of nucleotide (i.e., a pyrimidine for a pyrimidine [C for T, or vice versa] or a purine for a purine [A for G, or vice versa]).
- Translation.** The process whereby genetic information from mRNA is translated into protein.
- Translesion DNA synthesis.** A process of DNA damage tolerance that allows the DNA replication machinery to replicate past lesions in DNA.
- Translocation.** The transfer of genetic material from one chromosome to another chromosome. If there is an exchange of genetic

material between two chromosomes then this is referred to as a reciprocal translocation. A translocation between two acrocentric chromosomes by fusion at the centromeres is referred to as a Robertsonian translocation.

**Transmission disequilibrium test (TDT).** In statistics, a family-based association test for the presence of genetic linkage between a genetic marker and a clinical trait.

**Transposon.** Mobile genetic element able to replicate and insert a copy of itself at a new location in the genome.

**Transversion.** Substitution of a pyrimidine by a purine, or vice versa.

**Trilaminar.** In embryology, refers to the three cell layers of the blastocyst.

**Triple test.** The test that gives a risk for having a fetus with Down syndrome in mid-trimester as a function of age, serum  $\alpha$ -fetoprotein, estriol, and human chorionic gonadotropin levels.

**Triplet amplification or expansion.** Increase in the number of copies of triplet repeat sequences responsible for mutations in a number of single-gene disorders.

**Triplet code.** A series of three bases in the DNA or RNA molecule that codes for a specific amino acid.

**Triploid.** A cell with three times the haploid number of chromosomes (i.e., 3N).

**Trisomy.** The presence of a chromosome additional to the normal complement (i.e.,  $2N + 1$ ), so that in each somatic nucleus one particular chromosome is represented three times rather than twice.

**Trophoblast.** The outer cell mass of the early embryo that gives rise to the placenta.

**True fetal mosaicism.** Chromosomal mosaicism that is genuinely present in the body of the fetus as opposed to 'confined placental mosaicism' identified by chorionic villous biopsy.

**Truncate ascertainment.** See [Incomplete ascertainment](#).

**Tumor suppressor gene.** A gene (*aka* antioncogene) that protects a cell from a step on the cancer pathway, and when mutated, loss of its function contributes to cancer progression.

**Tyrosinase-negative albinism.** Form of oculocutaneous albinism with no melanin production that can be tested for in vitro.

**Tyrosinase-positive albinism.** Form of oculocutaneous albinism with some melanin production that can be tested for in vitro.

**U.** Abbreviation for uracil.

**Ultrasonography.** Use of ultrasonic sound waves to image objects at a distance (e.g., the developing fetus in utero).

**Unbalanced translocation.** A translocation in which there is an overall loss or gain of chromosomal material (e.g., partial monosomy of one of the portions involved and partial trisomy of the other portion involved).

**Unifactorial (= mendelizing).** Inheritance controlled by a single locus.

**Uniparental disomy.** When an individual inherits both chromosomes of a homologous pair from one parent.

**Uniparental heterodisomy.** Uniparental disomy resulting from inheritance of the two different homologs from one parent.

**Uniparental isodisomy.** Uniparental disomy resulting from inheritance of two copies of a single chromosome of a homologous pair from one parent.

**Unipolar illness.** Affective depressive illness.

**Universal donor.** A person of blood group O, Rh-negative, who can donate blood to any person irrespective of their blood group.

**Universal recipient.** A person of blood group AB, Rh-positive, who can receive blood from any donor irrespective of their blood group.

**Unstable mutation.** A mutation that, when transmitted, is passed on in altered form (e.g., triplet repeat mutations).

**Upstream.** Relating to DNA and RNA, in the direction of the 5' end (start) of the molecule.

**Uracil.** A pyrimidine base in RNA.

**Utrophin.** A gene on chromosome 6 with homology to the dystrophin gene.

**Variable (V).** In immunology, refers to the hypervariable regions of the large Y-shaped protein that is the immunoglobulin heavy chain antibody.

**Variable expressivity.** The variation in the severity of phenotypic features seen in people with autosomal dominant disorders (e.g., variable number of café-au-lait spots or neurofibromata in neurofibromatosis type I).

**Variable region.** The portion of the light and heavy chains of immunoglobulins that differs between molecules and helps to determine antibody specificity.

**Variants.** Alleles that occur less frequently than in 1% of the population.

**Vector.** A plasmid, phage or cosmid into which foreign DNA can be inserted for cloning.

**Virions.** Infectious viral particles.

**Virus.** A protein-covered DNA- or RNA-containing organism that is capable of replication only within bacterial or eukaryotic cells.

**Whole exome sequencing (WES).** A technique for sequencing all the expressed genes in a genome.

**Whole genome sequencing (WGS).** A technique or process determining the entire sequence of an organism's genome, including non-coding DNA.

**Wingless.** A group of morphogens produced by segment polarity genes.

**X-chromatin.** See [Barr body or Sex chromatin](#).

**X-inactivation.** See [Lyonization](#).

**X-inactivation center.** The part of the X chromosome responsible for the process of X-inactivation.

**X-linkage.** Genes carried on the X chromosome.

**X-linked dominant.** Genes on the X chromosome that manifest in heterozygous females.

**X-linked dominant lethal.** A disorder seen only in females as it is almost always incompatible with survival in hemizygous males (e.g. incontinentia pigmenti).

**X-linked recessive.** Genes that are carried by females and expressed in hemizygous males.

**Xanthomata.** Subcutaneous depositions of lipid, often around tendons; a physical sign associated with disordered lipid metabolism.

**Yeast artificial chromosome (YAC).** A plasmid-cloning vector that contains the DNA sequences for the centromere, telomere and autonomous chromosome replication sites that enable cloning of large DNA fragments up to 2 to 3 million base pairs in length.

**Y-linked inheritance.** See [Holandric inheritance](#).

**Zinc finger.** A finger-like projection formed by amino acids, positioned between two separated cysteine residues, which is stabilized by forming a complex with a zinc ion and can then bind specifically to DNA sequences; they are commonly found in transcription factors.

**Zona pellucida.** Cellular layer surrounding the mature unfertilized oocyte.

**Zone of polarizing activity.** An area on the posterior margin of the developing limb bud that determines the anteroposterior axis.

**Zoo blot.** A Southern blot of DNA from a number of different species used to look for evidence of DNA sequences conserved during evolution.

**Zygote.** The fertilized ovum.

## Websites and Clinical Databases

The exponential rate of generation of information about human, medical, and clinical genetics means that access to current information is vital to both the student and the doctor, particularly as patients and families often come to the clinic armed with the same information!

There are a large number of general websites that students may find useful as entry points, with a wealth of links to other sites. Many educational websites are now available and include a wealth of illustrative material.

Clinical geneticists regularly use a number of expert databases to assist in the diagnosis of genetic disorders and diseases, some of which are listed. Other specialized websites include mutation databases, information on nucleotide and protein sequences, and current projects such as HapMap (p. 135). Some additional websites have been listed under *Further Reading* at the end of chapters.

Lastly, students may find it of interest to look at the professional societies' websites as they contain many useful links.

### General Genetic Websites

#### Online Mendelian Inheritance in Man (OMIM)

<http://www.ncbi.nlm.nih.gov/omim/>

*Online access to McKusick's catalogue, an invaluable resource for clinical genetic information with a wealth of links to many other resources.*

#### GeneReviews

<http://www.ncbi.nlm.nih.gov/books/NBK1116/>

*Up-to-date reviews of many genetic and inherited conditions, each written by renowned experts in the field*

#### PubMed

<http://www.ncbi.nlm.nih.gov/pubmed>

*The single most useful source to access any published paper in the biomedical literature*

#### Genetic Alliance UK

<http://www.geneticalliance.org.uk/>

*Website for alliance of organizations supporting people affected with genetic disorders.*

#### Orphanet

<http://www.orpha.net/>

*A website with information about rare diseases, including many genetic disorders.*

#### Unique: The Rare Chromosome Support Group

<http://www.rarechromo.co.uk/html/home.asp>

*Unique produces excellent downloadable guides for many chromosomal disorders*

#### Contact a Family

<http://www.cafamily.org.uk/>

*An umbrella organization for patient support groups for rare disorders*

### Human Genome Websites

#### Database of Genomic Variants

<http://dgv.tcag.ca/dgv/app/home>

*A curated catalogue of human genomic structural variation.*

#### Policy, Legal, and Ethical Issues in Genetic Research

<http://www.nhgri.nih.gov/PolicyEthics/>

#### Ensembl Genome Browser

<http://www.ensembl.org/>

*Joint project between the European Bioinformatics Society and the Wellcome Trust Sanger Institute to provide annotated eukaryotic genomes.*

#### UCSC Genome Bioinformatics

<http://genome.ucsc.edu/>

*University of California at Santa Cruz genome browser.*

#### Human Genome Organization

<http://www.hugo-international.org/>

*The website for HUGO, the Human Genome Organization, which was set up as a "U.N. for the human genome".*

#### International HapMap Project

<ftp://ftp.ncbi.nlm.nih.gov/hapmap/>

*The website of the project to map common DNA variants.*

#### The 100,000 Genomes Project

<http://www.genomicsengland.co.uk/the-100000-genomes-project/>

*Run by Genomics England, this government funded initiative in the UK aims to bring a genomic medicine service into the NHS*

#### 1000 Genomes Project

<http://1000genomes.org/>

*A deep catalog of human genetic variation.*

#### Exome Aggregation Consortium (ExAC)

<http://exac.broadinstitute.org/>

*Variants from approximately 60,000 exomes*

#### Exome Variant Server (EVS)

<http://evs.gs.washington.edu/EVS/>

*Variants from approximately 5,000 exomes*

### Molecular Genetics Websites

#### Human Gene Mutation Database

<http://www.hgmd.cf.ac.uk/ac/index.php>

*A database of the reported mutations in human genes.*

#### BROAD Institute

<http://www.broad.mit.edu/>

*Human gene map, sequencing, and software programs.*

***In silico* tools for variant prediction**

VEP: <http://www.ensembl.org/info/docs/tools/vep/>  
 SIFT: <http://sift.jcvi.org/>  
 POLYPHEN2: <http://genetics.bwh.harvard.edu/pph2/>  
 ALIGNGVGD: [http://agvgd.hci.utah.edu/agvgd\\_input.php](http://agvgd.hci.utah.edu/agvgd_input.php)

**Mammalian Genetics Unit and Mouse Genome Centre**

<http://www.har.mrc.ac.uk/>  
*Mouse genome site.*

***Drosophila melanogaster* Genome Database**

<http://flybase.org/>  
*A comprehensive database for information on the genetics and molecular biology of D. melanogaster, including the genome sequence.*

***Caenorhabditis elegans* Genetics and Genomics**

<http://www.wormbase.org/#012-34-5>  
*C. elegans genome project information.*

**Yeast Genome Project**

<http://www.yeastgenome.org>  
*Yeast genome project information.*

**Cytogenetics Websites****Decipher Website**

<http://decipher.sanger.ac.uk/>  
*A database of submicroscopic chromosome imbalance that includes phenotypic data.*

**Educational Human Genetics Websites****Health Education England Genomics Education Programme**

<https://hee.nhs.uk/work-programmes/genomics/>  
<https://www.genomicseducation.hee.nhs.uk/>  
*Supporting education in genetics and genomics for health.*

**Dolan DNA Learning Center at Cold Spring Harbor Laboratory**

<http://www.dnalc.org/>  
*Information about genes in education.*

**University of Kansas Medical Center**

<http://www.kumc.edu/gec/>  
*For educators interested in human genetics and the Human Genome Project.*

**Human Genetics Societies****American Society of Human Genetics**

<http://www.ashg.org/>

**British Society for Genetic Medicine**

<http://www.bsgm.org.uk/>

**European Society of Human Genetics**

<http://www.eshg.org/>

**Human Genetics Society of Australasia**

<http://www.hgsa.org.au/>

**UK Genetic Testing Network**

<http://ukgtn.nhs.uk/>  
*An advisory organization that provides commissioning support to the NHS; genetic tests available in NHS laboratories are listed here*

**EDDNAL—European Directory of DNA Diagnostic Laboratories**

<http://www.eddnal.com/>  
*A European-wide directory – sometimes very useful for unusual test requests*

**Clinical Databases****London Medical Databases Online**

<http://www.fdna.com/london-medical-databases-online/>  
*London Medical Databases have partnered with Face2Gene to make the databases available online. Includes the Winter-Baraitser Dysmorphology Database, the Baraitser-Winter Neurogenetics Database, and the London Ophthalmic Genetics Database.*



# Multiple-Choice Questions

There may be more than one correct answer per question.

## CHAPTER 2: The Cellular and Molecular Basis of Inheritance

### 1. Base substitutions:

- May result in nonsense mutations
- Can affect splicing
- Are always pathogenic
- Can affect gene expression
- Result in frameshift mutations

### 2. Transcription:

- Describes the production of polypeptides from the mRNA template
- Occurs in the nucleus
- Produces single-stranded mRNA using the antisense DNA strand as a template
- Is regulated by transcription factors that bind to the 3' UTR
- Precedes 5' capping and polyadenylation

### 3. The following are directly involved in DNA repair:

- Glycosylases
- DNA polymerases
- Ligases
- Splicing
- Ribosomes

### 4. During DNA replication:

- DNA helicase separates the double-stranded DNA
- DNA is synthesized in one direction
- Okazaki fragments are synthesized
- DNA is synthesized in a conservative manner
- Uracil is inserted to pair with adenine

## CHAPTER 3: Chromosomes and Cell Division

### 1. Meiosis differs from mitosis in the following ways:

- Daughter cells are haploid, not diploid
- Meiosis is restricted to the gametes and mitosis occurs only in somatic cells
- In mitosis, there is only one division
- Meiosis generates genetic diversity
- The prophase stage of mitosis is one step; in meiosis I, there are four stages

### 2. Chromosome abnormalities reliably detected by light microscopy include:

- Trisomy
- Monosomy
- Reciprocal translocation
- Interstitial deletion
- Robertsonian translocation

### 3. Fluorescent in situ hybridization using whole-chromosome (painting) or specific locus probes enables routine detection of:

- Gene amplification
- Subtelomeric deletion
- Trisomy
- Supernumerary marker chromosomes
- Reciprocal translocation

### 4. Chemicals used in the preparation of metaphase chromosomes for analysis by light microscopy include:

- Colchicine
- Phytohemagglutinin
- Giemsa
- Quinacrine
- Hypotonic saline

## CHAPTER 4: Finding the Cause of Monogenic Disorders by Identifying Disease Genes

### 1. Positional cloning uses:

- Genetic databases
- Knowledge of orthologous genes
- Patients with chromosomal abnormalities
- Candidate genes selected by biological knowledge
- Microsatellite markers

### 2. A candidate gene is likely to be a disease-associated gene if:

- A loss-of-function mutation causes the phenotype
- An animal model with a mutation in the orthologous gene has the same phenotype
- Multiple different mutations cause the phenotype
- The pattern of expression of the gene is consistent with the phenotype
- It is a pseudogene

### 3. Achievements of the Human Genome Project include:

- Draft sequence published in 2000
- Sequencing completed in 2003
- Development of bioinformatics tools
- Identification of all disease-causing genes
- Studies of ethical, legal, and social issues

## CHAPTER 5: Laboratory Techniques for Diagnosis of Monogenic Disorders

### 1. The following statements apply to restriction enzymes:

- They can generate DNA fragments with 'sticky' ends
- They are viral in origin
- They are used to detect point mutations
- They are used in Southern blotting
- They are also called restriction exonucleases

### 2. The following describe the polymerase chain reaction (PCR):

- A type of cell-free cloning
- A process that uses a heat-labile DNA polymerase
- A very sensitive method of amplifying DNA that can be prone to contamination
- A technique that can routinely amplify up to 100 kb of DNA
- A method of amplifying genes that requires no prior sequence knowledge

### 3. Types of nucleic acid hybridization include:

- Southern blotting
- Microarray
- Western blotting
- Northern blotting
- DNA fingerprinting

## CHAPTER 6: Patterns of Inheritance

### 1. Concerning autosomal recessive inheritance:

- Females are more likely to be affected than males
- If both parents are carriers, the risk at conception that any child might be a carrier is 3/4
- Diseases following this pattern of inheritance are more prevalent in societies where cousin marriages are common
- Usually only a single generation has affected individuals
- Angelman syndrome follows this pattern

### 2. Concerning X-linked inheritance:

- The condition cannot be passed from an affected father to his son
- When recessive, an affected man will not see the condition in his children but it may appear in his grandchildren
- When dominant, females are usually as severely affected as males
- When dominant, there are usually more affected females than affected males in a family
- The risk of germline mosaicism does not need to be considered

### 3. In mitochondrial genetics:

- Heteroplasmy refers to the presence of more than one mutation in mitochondria
- Mitochondrial genes mutate less often than nuclear genes
- Mitochondrial conditions affect only muscle and nerve tissue
- The risk of passing on a mitochondrial condition to the next generation may be as high as 100%
- Mitochondrial diseases have nothing to do with nuclear genes

### 4. Concerning terminology:

- Locus heterogeneity means that the same disease can be caused by different genes on different chromosomes
- Pseudo-dominance refers to the risk to the offspring when both parents have the same dominantly inherited condition
- If a condition demonstrates reduced penetrance its phenotypic effects may skip generations
- Variable expression characterizes diseases that demonstrate anticipation
- Pleiotropy is simply a more technical term for variable expression

### 5. In inheritance:

- An autosomal recessive condition can occasionally arise through uniparental disomy
- Imprinted genes can be unmasked through uniparental disomy
- Digenic inheritance is simply another way of referring to uniparental disomy
- Hormonal factors may account for conditions demonstrating sex influence
- Most of the human genome is subject to imprinting

## CHAPTER 7: Population and Mathematical Genetics

### 1. In applying the Hardy-Weinberg equilibrium, the following assumptions are made:

- The population is small
- There is no consanguinity
- New mutations do not occur
- No babies are born by donor insemination, where the sperm from one donor is used multiple times
- There is no significant population migration

### 2. If the population incidence of a recessive disease is 1 in 10,000, the carrier frequency in the population is:

- 1 in 100
- 1 in 200
- 1 in 25
- 1 in 50
- 1 in 500

### 3. Heterozygote advantage:

- May lead to an increased incidence of autosomal dominant disorders
- Does not mean that biological fitness is increased in the homozygous state
- May explain the worldwide distribution of sickle cell disease and malaria
- May lead to distortion of the Hardy-Weinberg equilibrium
- Is very unlikely to be traced to a founder effect

### 4. Polymorphic loci:

- Are defined as those loci at which there are at least two alleles, each with frequencies greater than 10%
- Have been crucial to gene discoveries
- Can be helpful in determining someone's genetic status in a family
- Have nothing to do with calculating LOD scores
- By themselves have no consequence for genetically determined disease

**5. In population genetics:**

- To calculate the mutation rate for a disorder, it is necessary only to know the *biological fitness* for the condition
- If medical treatment can improve biological fitness, the frequency of an autosomal dominant condition will increase far more rapidly than that of an autosomal recessive condition
- Even when a large number of families is studied, the calculated segregation ratio for a disorder might not yield the expected figures for a given pattern of inheritance
- Founder effects seldom explain the high frequency of some alleles in genetic isolates
- Autozygosity mapping is a useful strategy to look for the gene in any autosomal recessive condition

**CHAPTER 8: Risk Calculation****1. Probabilities:**

- A probability of 0.5 is the same as a 50% risk
- The probability of an event never exceeds unity
- In a dizygotic twin pregnancy, the probability that the babies will be the same sex equals 0.5
- Bayes' theorem takes account of both prior probability and conditional information
- In an autosomal dominant condition, a penetrance of 0.7 means that 30% of heterozygotes will not manifest the disorder

**2. For an autosomal recessive condition, the chance that the first cousin of an affected individual is a carrier is:**

- 1 in 8
- 1 in 2
- 1 in 4
- 1 in 10
- 1 in 6

**3. In X-linked recessive inheritance:**

- The sons of a female carrier have a 1 in 4 chance of being affected
- The mother of an affected male is an obligate carrier
- The gonadal mosaicism risk in Duchenne muscular dystrophy may be as high as 15%
- For a woman who has an affected son, her chance of being a carrier is reduced if she goes on to have three unaffected sons
- A dummy consultand refers to an individual in a pedigree who is ignored when it comes to calculating risk

**4. In autosomal recessive inheritance, the carrier risk to the nephew of an affected individual, born to the affected individual's healthy sibling, is:**

- 1 in 2
- 1 in 4
- 2 in 3
- 1 in 3
- 1 in 6

**5. Risk-modifying information:**

- In calculating risk, conditional information can include negative DNA data
- In delayed onset of a dominantly inherited condition, calculation of heterozygote risk requires clinical expression data
- Calculating odds ratios does not require information about prior probabilities
- Empiric risks derived from epidemiological studies have limited application to a particular situation
- When using DNA marker data to predict risk, the recombination fraction does not really matter

**CHAPTER 9: Developmental Genetics****1. In development, HOX genes:**

- Function as transcription factors
- When mutated have been shown to be associated with many malformation syndromes
- Show very divergent structures across different species
- Are functionally redundant in postnatal life
- Individually can be important in the normal development of widely different body systems

**2. In the embryo and fetus:**

- Gastrulation is the process leading to the formation of the 16-cell early embryo 3 days after fertilization
- Organogenesis takes place at between 8 and 12 weeks' gestation
- The Notch signaling and Sonic hedgehog pathways are important for ensuring normal development in diverse organs and tissues
- Somites form in a caudo-rostral direction from the presomitic mesoderm
- TBX* genes appear to be crucial to normal limb development

**3. Concerning developmental pathways and processes:**

- In mammalian development, the jaw is formed from the second pharyngeal arch
- Pharyngeal arch arteries ultimately become the great vessels around the heart
- TBX1* is a key gene in the defects associated with DiGeorge syndrome
- Achondroplasia can be caused by a wide variety of mutations in the *FGFR3* gene
- Loss-of-function mutations and gain-of-function mutations usually cause similar defects

**4. Regarding the X-chromosome:**

- In most phenotypic males with a karyotype of 46,XX, the *SRY* gene is present and found on one of the X chromosomes
- In lyonization or X-chromosome inactivation, all the genes of one X chromosome are switched off
- As a result of lyonization, all females are X-chromosome mosaics
- Male fetal development is solely dependent on the *SRY* gene functioning normally
- X-chromosome inactivation may be linked in some way to the monozygotic twinning process

**5. Transcription factors:**

- Are RNA sequences that interfere with translation in the ribosomes
- Their only function is to switch off genes in development
- When mutated in *Drosophila* body segments may be completely reorganized
- Are not involved in defects of laterality
- Include genes that have a zinc finger motif

**CHAPTER 10: Common Disease, Polygenic and Multifactorial Genetics****1. Concerning autism:**

- It is best classified as an inborn error of metabolism
- The concordance rate in dizygotic twins is approximately 50%
- Fragile X syndrome is a major cause
- The risk to the siblings of an affected person is approximately 5%
- Girls are more frequently affected than boys

**2. Linkage analysis is more difficult in multifactorial conditions than in single-gene disorders because:**

- Variants in more than one gene are likely to contribute to the disorder
- The number of affected persons within a family is likely to be fewer than for a single-gene disorder
- The mode of inheritance is usually uncertain
- Some multifactorial disorders are likely to have more than one etiology
- Many multifactorial conditions have a late age of onset

**3. Association studies:**

- Can give false-positive results because of population stratification
- Include the transmission disequilibrium test (TDT)
- Positive association studies should be replicated
- Are used to map genes in multifactorial disorders
- Require closely matched control and patient groups

**4. Variants in genes that confer susceptibility to type 2 diabetes (T2DM) have been found:**

- By linkage analysis using affected sibling pairs
- Using animal models
- By candidate gene studies from monogenic subtypes of diabetes
- Through the study of biological candidates
- In isolated populations

**5. Variants in the *NOD2/CARD15* gene:**

- Are associated with Crohn disease and ulcerative colitis
- Can result in a 40-fold increased risk of disease
- Were identified after the gene was mapped to chromosome 16p12 by positional cloning
- Has led to novel therapies
- Are very rare in the general population

**CHAPTER 11: Screening for Genetic Disease****1.**

- X-inactivation studies provide a useful means of identifying female carriers of some X-linked disorders
- Reliable clinical signs to detect most carriers of X-linked disorders are lacking
- DNA sequence variants are useful in targeted screening as long as they are not polymorphic
- Hearing screening normally commences at 12 months of age
- For the purposes of screening family members, opportunities should be taken for the banking of DNA from probands with lethal conditions

**2.**

- Patients with presymptomatic tuberous sclerosis always have a characteristic facial rash
- It is always possible to diagnose neurofibromatosis type 1 by age 2 years because it is a fully penetrant condition
- Biochemical tests should not be considered as diagnostic genetic tests
- Magnetic resonance imaging of the lumbar spine may be useful in diagnosing Marfan syndrome
- Predictive genetic testing must always be done by direct gene analysis

**3.**

- Population screening programs should be legally enforced
- Population screening programs should be offered if some form of treatment or prevention is available
- The sensitivity of a test refers to the extent to which the test detects only affected individuals
- The positive predictive value of a screening test refers to the proportion of positive tests that are true positives
- If there is no effective treatment for a late-onset condition, predictive genetic testing should be undertaken with great care

**4.**

- A high proportion of people who undergo carrier testing cannot remember their result properly
- Carrier screening for cystic fibrosis is the most useful program among Greek Cypriots
- The possibility of a screening test leading to employment discrimination is not a major concern
- Neonatal screening for Duchenne muscular dystrophy improves life expectancy
- Neonatal screening for cystic fibrosis is a DNA-based test

**5.**

- Newborn screening for hemochromatosis, the most common mutated gene in European populations, is a nationally managed program in the United Kingdom
- The presymptomatic screening of children for adult-onset genetic disease is a decision made by the parents
- Neonatal screening for phenylketonuria and congenital hypothyroidism are the longest-running screening programs
- Screening for MCAD (medium-chain acyl-CoA dehydrogenase) deficiency is part of the newborn bloodspot screening program
- Genetic registers are mainly for research

## CHAPTER 12: Hemoglobin and the Hemoglobinopathies

### 1. For different hemoglobins:

- The fetal hemoglobin chain,  $\gamma$ , differs markedly from the adult  $\beta$  chain
- The Hb chains,  $\alpha$ ,  $\beta$ , and  $\gamma$  are all expressed throughout fetal life
- In  $\alpha$ -thalassemia, there are too many  $\alpha$  chains
- Hb Barts is a form of  $\beta$ -thalassemia
- Carriers of  $\beta$ -thalassemia frequently suffer from symptomatic anemia

### 2. Regarding sickle cell disease:

- The sickling effect of red blood corpuscles is the result of abnormal Hb binding with the red blood cell membrane
- Life-threatening thromboses can occur
- HbS differs from normal HbA by a single amino-acid substitution
- Splenic infarction may occur but this has little clinical consequence
- Point (missense) mutations are the usual cause of abnormal Hb in the sickling disorders

### 3. Concerning hemoglobin variants:

- Many Hb variants are harmless
- The types of mutation occurring in the hemoglobinopathies are very limited
- In the thalassemias, hypoplasia of the bone marrow occurs
- In the thalassemias, Hb demonstrates abnormal oxygen affinity
- In some thalassemias, increased red cell hemolysis occurs

### 4. Regarding hemoglobins during life:

- Persistence of fetal Hb into adult life is an acquired disorder
- Throughout fetal life, it is the liver that produces most of the body's Hb
- The bone marrow is not involved in Hb production before birth
- The liver continues to produce Hb into the second year of postnatal life
- Persistence of fetal Hb into adult life is a benign condition

## CHAPTER 13: Immunogenetics

### 1. Concerning complement:

- The complement cascade can be activated only by the binding of antibody and antigen
- C1-inhibitor deficiency can result in complement activation through the classic pathway
- C3 levels are reduced in hereditary angioneurotic edema
- Complement helps directly in the attack on microorganisms
- Complement is found mainly in the intracellular matrix

### 2. In immunology:

- The immunoglobulin molecule is made up of six polypeptide chains
- The genes for the various light and heavy immunoglobulin chains are found close together in the human genome
- Close relatives make the best organ donors because they are likely to share the same complement haplotypes
- The DNA encoding the  $\kappa$  light chain contains four distinct regions
- The diversity of T-cell surface antigen receptor can be compared with the process of immunoglobulin diversity

### 3. In immunity and immunological disease:

- Maternal transplacental mobility of antibodies gives infants protection for approximately 12 months
- X-linked severe combined immunodeficiency (SCID) accounts for approximately 5% to 10% of the total of SCID
- SCID, despite its name, is not always a severe condition
- There is always a T-cell abnormality in the different forms of SCID
- Chronic granulomatous disease (CGD) is a disorder of humoral immunity

### 4. In common immunological conditions:

- DiGeorge/Sedláčková syndrome is a primary disorder of immune function
- Severe opportunistic bacterial infections are uncommon in DiGeorge syndrome
- Genetic prenatal diagnosis is possible for common variable immunodeficiency
- Autoimmune disorders follow autosomal dominant inheritance
- Investigation of immune function should be considered in any child with failure to thrive

## CHAPTER 14: The Genetics of Cancer ... and Cancer Genetics

### 1. Relating to genetic mechanisms leading to cancer:

- Chromosome translocations can lead to cancer through modification of oncogene activity
- Oncogenes are the most common form of genes predisposing to hereditary cancer syndromes
- Defective apoptosis may lead to tumorigenesis
- Loss of heterozygosity (LOH) is another term for a mutational event in an oncogene
- A mutation in the *APC* gene is sufficient to cause colorectal cancer

### 2. In familial cancer syndromes (1):

- The two-hit hypothesis predicted that a tumor would develop when both copies of a critical gene are mutated
- TP53* mutations are found only in Li-Fraumeni syndrome
- The *RET* proto-oncogene is implicated in all forms of multiple endocrine neoplasia (MEN)
- Individuals with familial adenomatous polyposis (FAP) should have screening of the upper gastrointestinal tract
- Endometrial cancer is a feature of Lynch syndrome

**3. In familial cancer syndromes (2):**

- Thyroid cancer is a risk in Bannayan-Riley-Ruvalcaba syndrome
- Men with a germline mutation in *BRCA2* are at increased risk of prostate cancer
- The genetic basis of all familial breast cancer is now well established
- Familial breast cancer is usually fully penetrant
- For men with prostate cancer, 3% of male first-degree relatives are similarly affected

**4. In familial cancer syndromes (3):**

- Medulloblastoma is a common tumor in von Hippel-Lindau (VHL) disease
- Pheochromocytoma is frequently seen in Gorlin syndrome
- There is a risk of ovarian cancer in Peutz-Jeghers syndrome and Lynch syndrome
- Cutaneous manifestations occur in Peutz-Jeghers syndrome, Gorlin syndrome, and Lynch syndrome
- In two-thirds of Lynch syndrome cases the predisposing gene is unknown

**5. In cancer prevention and screening:**

- Screening for renal cancer in VHL is recommended
- Mammography detects breast cancer more easily in premenopausal than postmenopausal women
- Screening for retinoblastoma should begin in the second year of life
- Colonoscopy screening is indicated only when the Amsterdam criteria are fulfilled in relatives with colorectal cancer
- Preventive surgery is strongly indicated in FAP and women positive for *BRCA1* mutations

## CHAPTER 15: Pharmacogenetics, Personalized Medicine and the Treatment of Genetic Disease

**1. Thiopurine drugs used to treat leukemia:**

- Include 6-mercaptopurine, 6-thioguanine, and azathioprine
- Are also used to suppress the immune system
- May be toxic in 1% to 2% of patients
- Can have serious side-effects
- Are metabolized by thiopurine methyltransferase (TPMT)

**2. Liver enzymes that show genetic variation of expression and hence influence the response to drugs include:**

- UDP-glucuronosyltransferase
- O-acetyltransferase
- Alcohol dehydrogenase
- CYP2D6
- CYP2C9

**3. Examples of diseases in which treatment may be influenced by pharmacogenetics include:**

- Maturity-onset diabetes of the young (MODY), subtype glucokinase
- Maturity-onset diabetes of the young (MODY), subtype HNF-1 $\alpha$
- HIV infection
- Epilepsy
- Tuberculosis

**4. Methods currently used to treat genetic disease include:**

- Germ-cell gene therapy
- Stem-cell transplantation
- Enzyme/protein replacement
- Dietary restriction
- In situ repair of mutations by cellular DNA repair mechanism

**5. Gene therapy may be delivered by:**

- Liposomes
- Adeno-associated viruses
- Antisense oligonucleotides
- Lentiviruses
- Injection of plasmid DNA

**6. Gene therapy has been used successfully to treat patients with the following diseases:**

- Cystic fibrosis
- Severe combined immunodeficiency (XL-SCID)
- Sickle cell disease
- Hemophilia
- Adenosine deaminase deficiency

**7. Potential gene therapy methods for cancer include:**

- Inhibition of fusion proteins
- Stimulation of the immune system
- Increased expression of the angiogenic factors
- RNA interference
- Antisense oligonucleotides

## CHAPTER 16: Congenital Abnormalities, Dysmorphic Syndromes, and Learning Disability

**1.**

- Approximately 5% of all infant deaths are due to congenital abnormalities
- At least half of all spontaneous miscarriages have a genetic basis
- A major congenital abnormality affects approximately one newborn baby in every 200
- Positional talipes is an example of a disruption to normal intrauterine development
- Multiple abnormalities are sometimes the result of a sequence

2.
  - a. Down syndrome should more accurately be termed 'Down association'
  - b. Sotos syndrome, as with Down syndrome, is due to a chromosomal abnormality
  - c. Spina bifida affects approximately two per 1000 births
  - d. Infantile polycystic kidney disease is an example of a condition with different patterns of inheritance
  - e. Holoprosencephaly is an example of a condition with different patterns of inheritance
3.
  - a. Thalidomide embryopathy is an example of a disruption to normal intrauterine development
  - b. Talipes may be a consequence of renal agenesis
  - c. Limb defects are not a feature of fetal valproate syndrome
  - d. Symmetrical defects tend to feature in a dysplasia
  - e. Birth defects are unexplained in 10% of cases
4. **Relating to maternal influences on fetal development:**
  - a. Congenital infection could lead to someone being both blind and deaf
  - b. The mid-trimester is the most dangerous time for a fetus to be exposed to a maternal infection
  - c. Vertebral body defects can be a consequence of poorly treated diabetes mellitus in the first trimester
  - d. A polymorphism in the methylenetetrahydrofolate reductase (*MTHFR*) gene is always associated with an increased risk of neural tube defect
  - e. Pulmonary stenosis is a feature of Noonan syndrome and congenital rubella
5. **In conditions that are often non-mendelian**
  - a. Cleft lip-palate occurs more frequently than 1 in 1000 births
  - b. Associations generally have a high recurrence risk
  - c. The recurrence risk for a multifactorial condition can usually be determined by looking at the patient's family pedigree
  - d. One cause of holoprosencephaly is a metabolic defect
  - e. Congenital heart disease affects 1 in 1000 babies
2. **Relating to common chromosomal disorders:**
  - a. The life expectancy of children with trisomy 18 (Edwards syndrome) is about 2 years
  - b. 47,XYY males are fertile
  - c. The origin of Turner syndrome (45,X) can be in paternal meiosis
  - d. All persons with Angelman syndrome have a deletion on chromosome 15q detected by microarray-CGH analysis
  - e. DiGeorge syndrome results from misaligned homologous recombination between flanking repeat gene clusters
3. **In microdeletion conditions:**
  - a. Premature vascular problems occur in adults with Williams syndrome
  - b. Congenital heart disease is a feature of Prader-Willi and Smith-Magenis syndromes
  - c. The Wilms tumor locus is on chromosome 13
  - d. Aniridia may be caused by either a gene mutation or a chromosome microdeletion
  - e. A child's behavior may help to make a diagnosis of a malformation syndrome
4.
  - a. Klinefelter syndrome affects approximately 1 in 10,000 male live births
  - b. Learning difficulties are common in Klinefelter syndrome
  - c. Chromosome mosaicism is commonly seen in Turner syndrome
  - d. Females with a karyotype 47,XXX are infertile
  - e. Chromosome breakage syndromes can cause cancer
5.
  - a. In fragile X syndrome, the triplet repeat does not change in size significantly when passed from father to daughter
  - b. Fragile X syndrome is a single, well-defined, condition
  - c. Girls with bilateral inguinal hernia should have their chromosomes tested
  - d. Normal karyotyping is a good way of diagnosing fragile X syndrome in girls
  - e. Microarray-CGH analysis will detect genetic imbalances in approximately 50% of children with neurodevelopmental disorders

## CHAPTER 17: Chromosome Disorders

1. **Relating to aneuploidies:**
  - a. The chromosome number in humans was discovered after the structure of DNA
  - b. The Turner syndrome karyotype is the most common single chromosome abnormality in spontaneous abortuses
  - c. The rate of miscarriage in Down syndrome is similar to the rate in karyotypically normal fetuses
  - d. Most babies with Down syndrome are born to mothers who are less than 30 years of age
  - e. All children with Down syndrome have to go to special school

## CHAPTER 18: Inborn Errors of Metabolism

1. **In congenital adrenal hyperplasia (CAH):**
  - a. Females may show virilization and ambiguous genitalia
  - b. Males may show undermasculinization and ambiguous genitalia
  - c. Mineralocorticoid deficiency can be life threatening
  - d. Treatment is required during childhood but not usually in adult life
  - e. In affected females, fertility is basically unaffected
2. **Phenylketonuria:**
  - a. Is the only cause of a raised phenylalanine level in the neonatal period
  - b. Requires lifelong treatment
  - c. Is a cause of epilepsy and eczema
  - d. Results in reduced levels of melanin
  - e. Is part of the same pathway as cholesterol production

**3. Hepatomegaly is an important feature of:**

- Hurler syndrome
- Glycogen storage disorders
- Abnormalities of porphyrin metabolism
- Niemann-Pick disease
- Galactosemia

**4. Concerning mitochondrial disorders:**

- All follow matrilinear inheritance
- Retinal pigmentation and diabetes can both be features
- There are fewer than 50 gene products from the mitochondrial genome
- Leigh disease is always caused by the same point mutation
- The gene for Barth syndrome is known but the metabolic pathway is uncertain

**5. Regarding metabolic conditions:**

- The carnitine cycle and long-chain fatty acids are linked
- A single point mutation explains most cases of MCAD (medium-chain acyl-CoA dehydrogenase) deficiency
- Peroxisomal disorders include Menkes disease and Wilson disease
- Inborn errors of metabolism may present with hypotonia and acidosis alone
- X-rays are of no value in making a diagnosis of inborn errors of metabolism

## CHAPTER 19: Mainstream Monogenic Disorders

**1. Huntington disease:**

- In Huntington disease (HD), an earlier age of onset in the offspring is more likely if the gene is passed from an affected mother rather than an affected father
- In HD, those homozygous for the mutation are no more severely affected than those who are heterozygous
- From the onset of HD, the average duration of the illness until a terminal event is 35 years
- In HD, non-penetrance of the disease may be associated with low triplet repeat abnormal alleles
- Cognitive impairment and dementia are early features of symptomatic HD

**2. Myotonic dystrophy:**

- Insomnia is a feature of myotonic dystrophy
- Myotonic dystrophy is a cause of neonatal hypertonia
- The clinical effects of myotonic dystrophy are mediated through RNA
- Cardiac conduction defects are a feature of myotonic dystrophy and ion channelopathies
- In myotonic dystrophy type 2, as in myotonic dystrophy type 1, the disease is primarily caused by the expansion of a DNA trinucleotide repeating sequence

**3.**

- In cystic fibrosis the R117H mutation is the most common one in northern Europe
- In the *CFTR* gene a modifying intragenic polymorphism affects the phenotype
- Hypertrophic cardiomyopathies are mostly due to mutations in ion channelopathy genes
- Many different inherited muscular dystrophies can be linked to the complex that includes dystrophin (mutated in Duchenne and Becker muscular dystrophies)
- Learning difficulties are part of spinal muscular atrophy

**4.**

- Cystic fibrosis and hemophilia are unlikely candidates for gene therapy
- An abnormal span:height ratio alone is a major feature of Marfan syndrome
- Neurofibromatosis type 1 (NF1) often 'skips generations'
- Scoliosis can be a feature of both NF1 and Marfan syndrome
- Cataracts can be a feature of NF1 but not of NF2

**5. In neuromuscular conditions:**

- HMSN types I and II refer to a genetic classification
- HMSN can follow all major patterns of inheritance
- It is the nerve sheath, rather than the nerve itself, that is altered in the most common form of HMSN
- Estimation of the creatine kinase level and factor VIII level is good for identifying carriers of Duchenne dystrophy and hemophilia, respectively
- Brugada syndrome is one of the varieties of spinal muscular atrophy

## CHAPTER 20: Prenatal Testing and Reproductive Genetics

**1. In prenatal testing:**

- Amniocentesis is being routinely practiced earlier and earlier in pregnancy
- The cells grown from amniocentesis originate purely from fetal skin
- CVS is a safe procedure at 9 weeks' gestation
- The karyotype from chorionic villus tissue will always be a true reflection of the karyotype in the unborn baby
- Fetal anomaly scanning by ultrasound is reliable at 15 weeks' gestation

**2. Regarding prenatal markers:**

- In Down syndrome pregnancies, maternal serum human chorionic gonadotropin (hCG) levels are usually raised
- In Down syndrome pregnancies, maternal serum  $\alpha$ -fetoprotein ( $\alpha$ FP) concentration is usually reduced
- In trisomy 18 pregnancies, maternal serum markers behave in just the same way as in Down syndrome pregnancies
- About 95% of Down syndrome pregnancies are picked up by determining maternal age, serum  $\alpha$ FP and hCG levels, and fetal nuchal translucency
- Twin pregnancy is a cause of increased maternal serum  $\alpha$ FP levels



3.
  - a. The accuracy of fetal sexing by non-invasive prenatal testing on cell-free fetal DNA in the maternal circulation is less than 90%
  - b. Chromosome disorders are the main cause of abnormal nuchal translucency
  - c. Echogenic fetal bowel on ultrasonography is a risk factor for cystic fibrosis
  - d. For a couple who have had one child with Down syndrome, the risk in the next pregnancy is usually not greatly increased
  - e. Familial marker chromosomes are usually not clinically significant
4. **In assisted reproduction:**
  - a. Donor insemination is a procedure not requiring a license from the HFEA
  - b. Surrogacy is illegal in the United Kingdom
  - c. For preimplantation genetic diagnosis (PGD), fertilization of the egg is achieved by intracytoplasmic sperm injection (ICSI)
  - d. The success rate from a single cycle of IVF, in terms of taking home a baby, is 50%
  - e. The largest group of diseases being tested in PGD is single-gene conditions
5.
  - a. There is an increased risk of genetic conditions in the fathers of children conceived by ICSI
  - b. The sperm of one donor may be used up to 25 times
  - c. Children conceived by donor insemination are entitled to as much information as adopted children about their biological parents
  - d. Non-invasive prenatal diagnosis on cell-free fetal DNA in the maternal circulation is set to replace all other forms of prenatal testing and screening
  - e. Infertility affects about 1 in 20 couples

## CHAPTER 21: Genetic Counseling

1.
  - a. The individual who seeks genetic counseling is the proband
  - b. Retinitis pigmentosa mainly follows one pattern of inheritance
  - c. Genetic counseling is all about recurrence risks
  - d. The counselor's own opinion about a difficult choice is always helpful
  - e. Good counseling should not be measured by the patient's ability to remember genetic risks
2.
  - a. First-cousin partnerships are 10 times more likely to have babies with congenital abnormalities than the general population
  - b. On average, a grandparent and grandchild share 1/4 of their genes
  - c. Incestuous relationships virtually always result in severe learning difficulties in the offspring
  - d. Consanguinity should be regarded as extremely abnormal
  - e. Consanguinity refers exclusively to cousin marriages/partnerships
3.
  - a. Genetic disorders are accidents of nature, so guilt feelings are rare
  - b. Clear genetic counseling changes patients' reproductive decisions in virtually all cases
  - c. The chance of first cousins having their first child affected with an autosomal recessive condition due to a deleterious gene inherited from a grandparent is 1 in 32
  - d. Far more genetic testing of children for adoption takes place than for children reared by their birth parents
  - e. Patient support groups have little value given that modern medical genetics is so technically complex

# Case-Based Questions

## CHAPTER 6: Patterns of Inheritance

### Case 1

A 34-year-old man has developed spasticity of his legs in the past few years and his family has noted some memory problems and alteration in behavior. He has very brisk peripheral reflexes. He is seen with his mother in the genetic clinic and she is found to have significantly brisk peripheral reflexes on examination but has no health complaints. It emerges that her own father may have had similar problems to her son's when he was a young adult but he died in a road traffic accident aged 25.

1. Which patterns of inheritance need to be considered in this scenario?
2. What diagnostic possibilities should be considered?

### Case 2

A couple attend for genetic counseling prior to starting a family. Both have moderately severe congenital sensorineural hearing loss; *he* is the only affected individual in his family, with one sister who has normal hearing, and *she* has two siblings including one brother with a similar deafness diagnosis and no other affected family members.

1. What other information might be helpful before discussing possible genetic risks?
2. If all the additional enquiries and investigations are normal, what patterns of inheritance, and therefore risks to future offspring, need to be considered?

### Case 3

A couple has a child who suffers a number of bone fractures during early childhood after minor trauma and is told that this is probably a mild form of osteogenesis imperfecta. The parents did not suffer childhood fractures themselves, and when they have another child who also develops fractures they are told the inheritance is autosomal recessive. This includes an explanation that the affected children would be very unlikely to have affected offspring themselves in the future.

1. Is the information given to the parents correct?
2. If not, what is the most likely pattern of inheritance and explanation for the sibling recurrence of fractures?

## CHAPTER 7: Population and Mathematical Genetics

### Case 1

The incidence of a certain autosomal recessive disorder in population A is well established at approximately 1 in 10,000, whereas in population B the incidence of the same disorder is much higher at approximately 1 in 900. A man from population group

A and a woman from population group B are planning to marry and start a family. Being aware of the relatively high incidence of the disorder in population B, they seek genetic counseling.

1. What essential question must be asked of each individual?
2. What is the risk of the disorder occurring in their first pregnancy, based on application of the Hardy-Weinberg equilibrium?

### Case 2

Neurofibromatosis type 1 is a relatively common Mendelian condition. In a population survey of 50,000 people in one town, 12 cases are identified, of which 8 all belong to one large affected family.

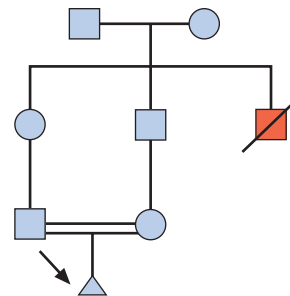
1. Based on these figures, what is the mutation rate in the neurofibromin gene?
2. Name some limitations to the validity of calculating the mutation rate from a survey such as this.

## CHAPTER 8: Risk Calculation

### Case 1

In the pedigree shown below, two cousins have married and would like to start a family. However, their uncle died many years ago from Hurler syndrome, one of the mucopolysaccharidoses, an inborn error of metabolism following autosomal recessive inheritance. No tissue samples are available for genetic studies.

1. What is the risk that the couple's first child will be affected by Hurler syndrome?
2. Can the couple be offered anything more than a risk figure?



### Case 2

A woman has a brother and a maternal uncle affected by hemophilia A. She herself has had two unaffected sons and would like more children. She is referred to a genetics clinic to discuss the risk and the options.

1. Purely on the basis of the information given, what is the woman's carrier risk for hemophilia A?
2. Can anything be done to modify her risk?

## CHAPTER 9: Developmental Genetics

### Case 1

A 2-year-old child is referred to geneticists because of a large head circumference above the 97th centile, although it is growing parallel to the centile lines. The parents would like to have another child and are asking about the recurrence risk. The cerebral ventricles are dilated and there has been much discussion with the neurosurgeons about possible ventriculoperitoneal shunting. On taking a full family history, it emerges that the paternal grandmother is under review by dermatologists for skin lesions, some of which have been removed, and a paternal uncle has had some teeth cysts removed by a hospital dentist.

1. *Is there a diagnosis that embraces the various features in these different family members?*
2. *What investigations would be appropriate for the child's father, and what is the answer to the couple's question about recurrence risk?*

### Case 2

On prenatal ultrasound at 20 weeks' gestation a fetus appears to have a narrow chest with short ribs, cystic changes in one kidney, and possibly an extra digit on both hands. The parents deny consanguinity but want as much information as possible about the diagnosis and prognosis.

1. *What group of disorders should be considered with these ultrasound findings, and which pattern of inheritance do they normally follow?*
2. *What additional anomalies might the ultrasonographer look for to help provide more prognostic information?*

### Case 3

A 4-year-old girl is brought to a pediatrician because of behavioral difficulties, including problems with potty training. The pediatrician decides to test the child's chromosomes by microarray-CGH because he has previously seen a case of 47,XXX (triple X) syndrome in which the girl had oppositional behavior. Somewhat to his surprise the chromosome result is 47,XY—i.e., the 'girl' is genetically 'male'.

1. *What are the most important causes of sex reversal in a 4-year-old child who is phenotypically female and otherwise physically healthy?*
2. *What should the pediatrician tell the parents, and which investigations should be performed?*

## CHAPTER 10: Common Disease, Polygenic and Multifactorial Genetics

### Case 1

A 16-year-old requests oral contraceptives from her general practitioner. On taking a family history, it emerges that her mother had a deep vein thrombosis at the age of 40 years and died after a pulmonary embolism at age 55 years. There is no other relevant family history.

1. *What genetic testing is appropriate?*
2. *What are the limitations of testing in this situation?*

### Case 2

A 35-year-old woman is diagnosed with diabetes and started on insulin treatment. She and her 29-year-old brother were adopted and have no contact with their birth parents. Her brother has no symptoms of hyperglycemia. Both have normal hearing and no other significant findings.

1. *What possible subtypes of diabetes might she have and what are the modes of inheritance of these subtypes?*
2. *For each of these subtypes, what is the risk of her brother developing diabetes?*

### Case 3

A 2-year-old girl presents with partial seizures. The episode is brief and unaccompanied by fever. Because the child is well with no neurological deficit, a decision is made not to treat with an anti-convulsant drug. A year later she suffers a generalized seizure, again without fever. On this occasion, her 30-year-old mother asks whether this might have anything to do with her own seizures that began at the age of 15 years, although she has had only two episodes since. She had undergone computed tomography of the brain and the doctors mentioned a condition whose name she could not remember. Magnetic resonance imaging of the child's brain shows uncalcified nodules on the lateral ventricular walls.

1. *The mother asks whether the epilepsy is genetic and whether it could happen again if she has another child. What can she be told?*
2. *What diagnoses should be considered and can genetic testing be offered?*

### Case 4

A 5-year-old boy is admitted to hospital with an unexplained fever and found to have a raised blood glucose level. He makes a good recovery, but 2 weeks later his fasting blood glucose level is shown to be increased at 7 mmol/L. There is a strong family history of diabetes on his mother's side, with his mother, maternal uncle, and maternal grandfather all affected. His father has no symptoms of diabetes, but his father's sister had gestational diabetes during her recent pregnancy. Molecular genetic testing identifies a heterozygous glucokinase gene mutation in the child.

1. *The parents believe that their son's hyperglycemia is inherited from the mother's side of the family. Is this correct?*
2. *What are the consequences of finding a glucokinase gene mutation for this family?*

## CHAPTER 11: Screening for Genetic Disease

### Case 1

A 32-year-old man is tall and thin, has a normal echocardiogram, and 20 years ago his father died suddenly at age 50 years, having been suspected of having a thoracic aortic aneurysm. The general practitioner wonders whether his patient has Marfan syndrome and refers him to the local genetics service. He has some features of Marfan syndrome but, strictly speaking, would meet the accepted criteria only if the family history was definitely positive for the disorder. He has a brother of average height and three young children who are in good health.

1. *In terms of genetic testing, what are the limitations to screening if the diagnosis is Marfan syndrome?*
2. *What are the screening issues for the family?*

**Case 2**

A screening test for cystic fibrosis (CF) is being evaluated on a population of 100,000 newborn babies. The test is positive in 805 babies, of whom 45 are eventually shown to have CF by a combination of DNA analysis and sweat testing. Of those babies whose screening test is negative, five subsequently develop symptoms and are diagnosed with CF.

1. What is the sensitivity and specificity of this screening test?
2. What is the positive predictive value of the screening test?

**CHAPTER 12: Hemoglobin and the Hemoglobinopathies****Case 1**

A Chinese couple residing in the United Kingdom has had two pregnancies and the outcome in both was a stillborn edematous baby (hydrops fetalis). These pregnancies occurred when they lived in Asia and they have no living children. They seek some genetic advice about the chances of this happening again, but no medical records are available for the pregnancies.

1. What diagnostic possibilities should be considered?
2. What investigations are appropriate to this situation?

**Case 2**

A young adolescent whose parents are of West Indian origin is admitted from accident and emergency after presenting with severe abdominal pain and some fever. An acute abdomen is suspected and the patient undergoes laparotomy for possible appendicitis. However, no surgical pathology is identified. Subsequently the urine appears dark.

1. What other investigations might be appropriate at this stage?
2. What form of follow-up is appropriate?

**CHAPTER 13: Immunogenetics****Case 1**

A 32-year-old man has had low back pain and stiffness for 2 years and recently developed some irritation in his eyes. Radiography is performed and a diagnosis of ankylosing spondylitis made. He remembers his maternal grandfather having similar back problems as well as arthritis in other joints. He has three young children.

1. Is it likely that his grandfather also had ankylosing spondylitis?
2. What is the risk of passing the condition to his three children?

**Case 2**

A 4-year-old girl suffers frequent upper respiratory infections with chest involvement, and each episode lasts longer than in her preschool peers. Doctors have always assumed this is somehow a consequence of her stormy early months, when she had major heart surgery for tetralogy of Fallot. She also has nasal speech and in her neonatal record she had low calcium levels for a few days.

1. Is there an underlying diagnosis that could explain her frequent and prolonged upper respiratory infections?
2. What further management of the family is indicated?

**CHAPTER 14: The Genetics of Cancer ... and Cancer Genetics****Case 1**

A 38-year-old woman, who recently had a mastectomy for breast cancer, requests a referral to the genetic service. Her father had some bowel polyps removed in his 50s and a cousin on the same side of the family had some form of thyroid cancer in her 40s. The general practitioner consults a set of guidelines that suggest a familial form of breast cancer is unlikely because she is the only one affected, even though quite young. He is reluctant to refer her.

1. Could the history suggest another familial condition? If so, which one?
2. What other clinical features might give a clue to the diagnosis?

**Case 2**

A 30-year-old is referred for genetic counseling because she is concerned about her risk of developing breast cancer. The consultand's mother has recently been diagnosed with breast cancer at age 55. Her maternal uncle's daughter (the consultand's cousin) had bilateral breast cancer diagnosed at age 38 and died 5 years ago from metastatic disease. The cousin had participated in a research study that identified a *BRCA2* gene mutation. The clinical geneticist suggests that the consultand's mother should be tested before predictive testing is offered to her, the consultand. They are surprised when a negative result is reported by the laboratory.

1. What are the possible explanations for this result?
2. What is the risk of the consultand's uncle developing breast cancer?

**Case 3**

A 58 year-old man has been diagnosed with a colorectal adenocarcinoma affecting the ascending colon. His paternal grandmother is believed to have died of renal cancer whilst a female cousin on the same side of the family was diagnosed with endometrial cancer at the age of 50. The proband has three children in their mid-late 30s.

1. Does this pattern of malignancies suggest a known family cancer syndrome, and if so how might it be investigated?
2. Without any further information, what screening advice might be suggested for the proband's three children?

**CHAPTER 16: Congenital Abnormalities, Dysmorphic Syndromes, and Learning Disability****Case 1**

A young couple has just lost their first pregnancy through fetal abnormality. Polyhydramnios was diagnosed on ultrasonography as well as a small fetal kidney on one side. Amniocentesis was performed and the karyotype showed a normal 46,XY pattern. The couple was unsure what to do, but eventually elected for a termination of pregnancy at 21 weeks. They were very upset and did not want any further investigations performed, including an autopsy. They did agree to whole-body radiography of the fetus and some of the upper thoracic vertebrae were misshapen.

1. The couple asks whether such a problem could recur—they do not feel they can go through this again. What can they be told?
2. What further investigations might have helped to inform the genetic risk?

### Case 2

On routine neonatal examination on the second day, a baby is found to have a cleft palate. The pregnancy was uneventful with no exposure to potential teratogens, and the family history is negative. The pediatric registrar also wonders whether the limbs are slightly short. The baby's birth weight is on the 25th percentile, with length on the 2nd percentile.

1. What diagnoses might be considered?
2. What are the management issues in a case like this?

### Case 3

A couple have a 10 year-old daughter with severe intellectual disability, a history of hypotonia and feeding difficulties, almost no spoken language, growth parameters within the normal range, and some soft dysmorphic features. There is no history of seizures. They have put off trying to extend their family because of concern that they might have another affected child and ask if anything further can be done.

1. Without more information or investigations, what general comments can be made about the recurrence risk if they decide to try for another baby?
2. What investigative options are available to help the couple further?

## CHAPTER 17: Chromosome Disorders

### Case 1

A newborn baby girl looks somewhat dysmorphic, is diagnosed with an atrioventricular septal defect, and the pediatricians think this may be Down syndrome. This is discussed with the parents and microarray-CGH performed. The result comes back as normal. The baby is very 'good' during infancy with very little crying, and no further investigations are done. Subsequently the child shows moderate-severe global developmental delay, head-banging, wakes every night for about 4 hours, tends to hug people excessively, and has mild brachydactyly. The pediatricians refer her to a geneticist for an opinion.

1. Does the history suggest a diagnosis?
2. What investigation should be requested?

### Case 2

The parents of a 10-year-old girl seek a follow-up appointment in the genetics clinic. At the age of 4 years, she had behavioral problems and microarray-CGH was performed from a blood sample. The result came back as 47,XXX and it was explained that these girls sometimes do have behavioral problems, are usually tall, fertility is normal, and 'everything would be alright'. However, by age 10 years she is the smallest girl in the class and still has a slightly webbed neck that had first been noted in the neonatal period.

1. What diagnosis should be considered and what investigation should now be offered?
2. How are the genetic counseling and future management modified by the new diagnosis?

### Case 3

A pediatrician arranges a microarray-CGH test for an 8 year-old boy whose school performance is poor and he requires additional support. He also has behavioral problems with social communication difficulties and there is much discussion as to whether he should be assessed for possible autism. The professionals are inclined towards the view that poor parenting and difficult circumstances contribute to the overall problem because mother looks after him and three other children on her own and she was a low achiever at school herself. The microarray-CGH result reveals a small deletion of 15q11.2 and the child is referred to a clinical geneticist.

1. How might the microarray-CGH finding help explain the situation at school and at home?
2. What further investigations are indicated?

## CHAPTER 18: Inborn Errors of Metabolism

### Case 1

A 2-year-old boy, who has a baby sister age 4 months, is admitted to hospital with a vomiting illness and drowsiness. Despite vomiting his symptoms improve quickly with intravenous fluid support, but his blood glucose remains low and intravenous fluids are required longer than might normally be expected. The parents say that something like this happened before, although he recovered without seeing a doctor.

1. What does this history suggest?
2. What investigations are appropriate?

### Case 2

A one year-old boy presents with tachypnoea, especially on feeding, and motor milestones are slightly delayed. His mother says that she had a maternal great aunt who was believed to have had two sons who both died in late childhood from some 'heart and muscle weakness' problem. On investigation the boy is found to have a dilated cardiomyopathy and mild general muscle weakness.

1. What condition is suggested by the combination of clinical features and family history?
2. What further investigations are indicated?

### Case 3

A 28-year-old woman has become aware over several years that she does not have the same energy as she did at the age of 20. She tires relatively easily on exertion and family members have noticed that she has developed slightly droopy eyelids, and they also think her hearing is deteriorating, which she vigorously denies.

1. How might a detailed family history help towards a diagnosis in this case?
2. What investigations should be performed?

## CHAPTER 19: Mainstream Monogenic Disorders

### Case 1

A 31-year-old woman would like to start a family but is worried because her 39-year-old brother was diagnosed as having Becker muscular dystrophy nearly 30 years ago and she remembers having

being told that the condition affects boys but the women pass it on. Her brother is still living, but is now quite disabled by his condition. There is no wider family history of muscular dystrophy.

1. *Is the original diagnosis reliable—could there be other possibilities?*
2. *What are the next steps in investigating this situation?*

### Case 2

A middle-aged couple is devastated when their 21-year-old daughter collapses at a dance and cannot be resuscitated. At postmortem examination, all toxicology tests are negative and no cause of death is found. The mother recalls that her father died suddenly in his 50s from what was presumed at the time to be a cardiac cause, and her sister has had some dizzy spells but has not seen her doctor. The couple has three other children who are young, sport-loving adults and they are very worried that this might happen again.

1. *What investigations are appropriate?*
2. *What advice should the family be given?*

### Case 3

A young man of 21 years has suffered a spontaneous pneumothorax which is resolving well. He is found to have some joint laxity and a high palate with a history of dental crowding. The physicians suggest he may have Marfan syndrome and perform an echocardiogram, which highlights mild mitral valve regurgitation. He mentions that his maternal grandfather suffered an aortic aneurysm aged 60 and died. The physicians refer him to clinical genetics with a diagnosis of probable Marfan syndrome.

1. *What steps can be taken to confirm or refute a diagnosis of Marfan syndrome?*
2. *If the diagnosis is not Marfan syndrome, what other conditions might be considered?*

## CHAPTER 20: Prenatal Testing and Reproductive Genetics

### Case 1

A 36-year-old pregnant woman elects to undergo prenatal testing by chorionic villus biopsy after the finding of increased nuchal translucency on ultrasonography. The initial result, using QF-PCR, is good news—there is no evidence for trisomy 21—and the woman is greatly relieved. However, on the cultured cells more than 2 weeks later, it emerges that there is mosaicism for trisomy 20. She undergoes amniocentesis a week later, and 3 weeks after that the result also shows some cells with trisomy 20.

1. *Why was an amniocentesis performed in addition to the chorionic villus biopsy?*
2. *What else can be done following the amniocentesis result?*

### Case 2

A couple has two autistic sons and would very much like to have another child. They are prepared to do anything to ensure

that the problem does not recur. They acquire a lot of information from the internet and learn that boys are more commonly affected—the male:female sex ratio is approximately 4:1. As they see it, the simple solution to their problem is sex selection by preimplantation genetic diagnosis (PGD).

1. *What investigations might be performed on the autistic sons?*
2. *If tests on the sons fail to identify a diagnosis, can the request of the couple for sex selection by PGD be supported by the geneticist?*

### Case 3

A 37 year-old woman whose father had hemophilia A has just learned that she is pregnant for the first time—6 weeks' gestation. She requests prenatal testing as her father suffered significantly during his life and she does not want to see the problem recur. She is also worried about Down syndrome on account of her age. She is first of all offered a blood test 2 weeks later and told it may not be necessary to perform a CVS or amniocentesis.

1. *What blood test is this and how might it avoid the need for an invasive prenatal test?*
2. *What statistical information should she have been given about the sensitivity of the test?*

## CHAPTER 21: Genetic Counseling

### Case 1

A couple has a son with dysmorphic features, short stature, and moderately severe developmental delay. Microarray-CGH analysis identifies a subtle genetic imbalance that was not detected on a standard karyotype, and the father is found to have a balanced translocation that predisposed to this. His family has always blamed the mother for the child's condition because of her history of drug abuse, with the result that the couple no longer talk to his wider family. If they do try and explain the issues to his wider family they believe a lot of derogatory and inaccurate information will be posted on social media. However, through friends he has learned that his sister is trying to start a family.

1. *What are the important genetic issues?*
2. *What other issues does this case raise?*

### Case 2

A couple has a child who is diagnosed with cystic fibrosis (CF) through neonatal screening. The child is homozygous for the common p.Phe508del mutation. They request prenatal diagnosis in the next pregnancy, but DNA analysis shows that the father is not a carrier of p.Phe508del. It must be assumed he is not the biological father of the child with CF, and this is confirmed when further analysis shows that the child does not have a haplotype in common with him.

1. *What medical issue does this information raise?*
2. *What counseling issues are raised by these results?*

# Multiple-Choice Answers

## CHAPTER 2: The Cellular and Molecular Basis of Inheritance

### 1. Base substitutions:

- True.** When a stop codon replaces an amino acid
- True.** For example, by mutation of conserved splice donor and acceptor sites
- False.** Silent mutations or substitutions in non-coding regions may not be pathogenic
- True.** For example, promoter mutations may affect binding of transcription factors
- False.** Frameshifts are caused by the insertion or deletion of nucleotides

### 2. Transcription:

- False.** During transcription mRNA is produced from the DNA template
- True.** The mRNA product is then translocated to the cytoplasm
- True.** The mRNA is complementary to the antisense strand
- False.** Transcription factors bind to regulatory sequences within the promoter
- True.** The addition of the 5' cap and 3' poly(A) tail facilitates transport to the cytoplasm

### 3. The following are directly involved in DNA repair:

- True.** The DNA glycosylase MYH is involved in base excision repair (BER)
- True.** They incorporate the correct bases
- True.** They seal gaps after abnormal base excision and correct base insertion
- False.** Splicing removes introns during mRNA production
- False.** Ribosomes are involved in translation

### 4. During DNA replication:

- True.** It unwinds the DNA helix
- False.** Replication occurs in both directions
- True.** These fragments are joined by DNA ligase to form the lagging strand
- False.** DNA replication is semiconservative as only one strand is newly synthesized
- False.** Uracil is incorporated in mRNA, thymine in DNA

## CHAPTER 3: Chromosomes and Cell Division

### 1. Meiosis differs from mitosis in the following ways:

- True.** During human meiosis, the number of chromosomes is reduced from 46 to 23
- False.** Early cell divisions in gametogenesis are mitotic; meiosis occurs only at the final division
- True.** In meiosis, the two divisions are known as meiosis I and II
- True.** The bivalents separate independently during meiosis I, and crossovers (chiasmata) occur between homologous chromosomes
- False.** The five stages of meiosis I prophase are leptotene, zygotene, pachytene, diplotene, and diakinesis

### 2. Chromosome abnormalities reliably detected by light microscopy include:

- True.** An extra chromosome (e.g., chromosome 21 in Down syndrome) is easily seen
- True.** A missing chromosome (e.g., Turner syndrome in females with a single X) is easily seen
- False.** A subtle translocation may not be visible
- False.** A small deletion may not be visible
- True.** Centric fusion of the long arms of two acrocentric chromosomes is readily detected

### 3. Fluorescent in situ hybridization using whole-chromosome (painting) or specific locus probes enables routine detection of:

- False.** Changes in gene dosage may be identified by comparative genomic hybridization (CGH)
- True.** Subtelomeric probes are useful in the investigation of non-specific learning difficulties
- True.** Trisomies can be detected in interphase cells
- True.** The origin of marker chromosomes can be determined by chromosome painting
- True.** Subtle rearrangements can be detected by chromosome painting

### 4. Chemicals used in the preparation of metaphase chromosomes for analysis by light microscopy include:

- True.** Colchicine inhibits spindle formation, thus arresting cells at metaphase
- True.** Phytohemagglutinin stimulates cell division of T lymphocytes
- True.** Giemsa is used to stain chromosomes a pink/purple color
- False.** Quinacrine is a fluorescent stain not visible by light microscopy
- True.** Hypotonic saline swells the cells, causing cell lysis and spreading of chromosomes

## CHAPTER 4: Finding the Cause of Monogenic Disorders by Identifying Disease Genes

### 1. Positional cloning uses:

- True.** Now that the human genome sequence is complete, it is possible to identify a disease-associated gene *in silico*
- True.** After a gene has been mapped to a region, it can be helpful to check for syntenic regions in animal models
- True.** Many genes have been identified through mapping of translocation or deletion break-points
- False.** Positional cloning describes the search for genes based on their chromosomal location
- True.** A genome-wide scan uses microsatellite markers located throughout the genome for linkage mapping

### 2. A candidate gene is likely to be a disease associated gene if:

- True.** This implies causality
- True.** This is strong evidence
- True.** This excludes the possibility that a single variant is a marker in linkage disequilibrium rather than a pathogenic mutation
- True.** For example, a gene associated with blindness might be expected to be expressed in the eye
- False.** A pseudogene does not encode a functional protein and mutations are therefore unlikely to be pathogenic

### 3. Achievements of the Human Genome Project include:

- False.** The draft sequence was completed in 2000, but its publication date was February 2001
- True.** Sequencing was finished 2 years ahead of the original schedule
- True.** Annotation tools such as Ensembl were developed to assist users
- False.** More than 4500 have been identified to date but the number is increasing rapidly
- True.** Around 5% of the US budget for the Human Genome Project was devoted to studying these issues

## CHAPTER 5: Laboratory Techniques for Diagnosis of Monogenic Disorders

### 1. The following statements apply to restriction enzymes:

- True.** Double-stranded DNA can be digested to give overhanging (sticky) ends or blunt ends
- False.** More than 300 restriction enzymes have been isolated from various bacteria
- True.** If the mutation creates or destroys a recognition site
- True.** DNA digestion by a restriction enzyme is the first step in Southern blotting
- False.** They are endonucleases as they digest DNA fragments internally, as opposed to exonuclease digestion from the 5' or 3' ends of DNA fragments

### 2. The following describe polymerase chain reaction (PCR):

- True.** Millions of copies of DNA can be produced from one template without using cloning vectors
- False.** PCR uses the heat-stable Taq polymerase, because a high denaturing temperature (around 95°C) is required to separate double-stranded products at the start of each cycle
- True.** PCR may be used to amplify DNA from single cells (e.g., in preimplantation genetic diagnosis); therefore, appropriate control measures are important to avoid contamination
- False.** PCR routinely amplifies targets of up to 1 kb and long-range PCR is limited to around 40 kb
- False.** Knowledge of the sequence is required to design primers to flank the region of interest

### 3. Types of nucleic acid hybridization include:

- True.** Southern blotting describes the hybridization of a radioactively labeled probe with DNA fragments separated by electrophoresis
- True.** Hybridization between the target and probe DNA takes place on a glass slide
- False.** Western blotting is used to analyze protein expression using antibody detection methods
- True.** Northern blotting is used to examine RNA expression
- True.** DNA fingerprinting employs a minisatellite DNA probe to hybridize to hypervariable DNA fragments

### 4. The following techniques can be used to screen genes for unknown mutations:

- True.** Sequencing can be used to detect known or unknown mutations and will characterize an unknown mutation
- True.** SSCP is an inexpensive method for mutation screening although its sensitivity is limited
- True.** DHPLC is an efficient method for detecting heterozygous mutations
- False.** Oligonucleotide ligation assay is used to detect known mutations as the probe design is mutation specific
- False.** Real-time PCR is also used to detect known mutations as the probe design is mutation specific

## CHAPTER 6: Patterns of Inheritance

### 1. Concerning autosomal recessive inheritance:

- False.** Sex ratio is equal
- False.** The risk at the time of conception is 1/2
- True.** All people carry mutated genes; consanguineous couples are more likely to have the same pathogenic gene variant inherited from a common ancestor
- True.** Affected individuals would have to partner a carrier or another affected person for their offspring to be affected as well
- False.** The mechanisms causing Angelman syndrome are varied but autosomal recessive inheritance is not one of them



**2. Concerning X-linked inheritance:**

- a. **True.** A father passes his Y chromosome to his son
- b. **True.** He might have affected grandsons through his daughters, who are obligate carriers
- c. **False.** Although the condition affects females, in most diseases inherited in this way the males are more severely affected because the female has a normal copy of the gene on her other X chromosome, and X-inactivation means that the normal copy is expressed in about half of her tissues
- d. **True.** All daughters of an affected man will be affected, but none of his sons
- e. **False.** Germline mosaicism always needs to be considered when an isolated case of an X-linked condition occurs

**3. In mitochondrial genetics:**

- a. **False.** This refers to two populations of mitochondrial DNA, one normal, one mutated
- b. **False.** The opposite, probably because they replicate more frequently
- c. **False.** Any tissue with mitochondria can be affected
- d. **True.** If the affected woman's oocytes contain only mutated mitochondria
- e. **False.** Many mitochondrial proteins of the respiratory chain and its complexes are encoded by nuclear genes

**4. Concerning terminology:**

- a. **False.** The same disease caused by different genes—but not necessarily on different chromosomes
- b. **False.** The basic pattern of inheritance in pseudo-dominance is autosomal recessive
- c. **True.** A proportion of individuals with the mutated gene show no signs or symptoms
- d. **True.** Diseases showing anticipation demonstrate increased severity, and earlier age of onset, with succeeding generations
- e. **False.** Not a variation in severity (or variable expression), but two or more apparently unrelated effects from the same gene

**5. In inheritance:**

- a. **True.** Both copies of a mutated gene can be passed to a child this way
- b. **True.** This explains a proportion of cases of Prader-Willi and Angelman syndromes
- c. **False.** Digenic inheritance refers to a phenotype that results from heterozygosity for two different genes
- d. **True.** This explains presenile baldness and gout
- e. **False.** Only a small proportion

**CHAPTER 7: Population and Mathematical Genetics****1. In applying the Hardy-Weinberg equilibrium, the following assumptions are made:**

- a. **False.** The population should be large to increase the likelihood of non-random mating
- b. **True.** Consanguinity is a form of non-random mating
- c. **True.** The introduction of new alleles introduces variables
- d. **True.** In theory, if sperm donors are used many times this could introduce a form of non-random mating
- e. **True.** Migration introduces new alleles

**2. If the population incidence of a recessive disease is 1 in 10,000, the carrier frequency in the population is:**

- a. **False.**
- b. **False.**
- c. **False.**
- d. **True.** The carrier frequency is double the square root of the incidence
- e. **False.**

**3. Heterozygote advantage:**

- a. **False.** It refers to conditions that follow autosomal recessive inheritance
- b. **True.** The homozygote may show markedly reduced biological fitness (e.g., cystic fibrosis)
- c. **True.** People with sickle-cell trait are more able to remove parasitized cells from the circulation
- d. **True.** A process of selective advantage may be at work
- e. **False.** The presence of the allele in a population may indeed be a founder effect

**4. Polymorphic loci:**

- a. **False.** The alleles need have only low frequencies, e.g. 1%
- b. **True.** They are crucial to gene mapping by virtue of their co-segregation with disease
- c. **True.** Although direct mutation analysis can usually be employed, linkage analysis using polymorphic loci may in some circumstances be the only way to determine genetic status in presymptomatic diagnosis and prenatal testing
- d. **False.** The association of polymorphic loci with disease segregation is key to calculating a logarithm of the odds (LOD) score
- e. **False.** They may be important (e.g., blood groups)

**5. In population genetics:**

- a. **False.** The *incidence* of the disease must also be known
- b. **True.** In autosomal recessive disease most of the genes in the population are present in unaffected heterozygotes
- c. **True.** In recessive conditions unaffected sibships will not be ascertained
- d. **False.** Founder effects are the main reason for the high frequency of certain alleles in population groups where consanguinity rates are often high; this applies particularly to autosomal recessive conditions
- e. **False.** It is useful only when there is a common ancestor from both sides of the family, (i.e., inbreeding)

**CHAPTER 8: Risk Calculation****1. Probabilities:**

- a. **True.** These are two ways of expressing the same likelihood
- b. **True.** A probability of 1 means that the event will happen 100% of the time
- c. **True.** The probability that both will be boys is  $1/2 \times 1/2 = 1/4$ , for girls the same; therefore the chance of being the same sex is  $1/4 + 1/4 = 1/2$  (0.5)
- d. **True.** These two approaches to a probability calculation are essential
- e. **True.** 70% of heterozygotes will manifest the condition

**2. For an autosomal recessive condition the chance that the first cousin of an affected individual is a carrier is:**

- False.
- False.
- True. The affected individual's parents are obligate carriers, aunts and uncles have a 1 in 2 risk, cousins a 1 in 4 risk
- False.
- False.

**3. In X-linked recessive inheritance:**

- False. The risk is 1 in 2 if the sex of the fetus is known to be male
- False. The male might be affected because a new mutation has occurred
- True. This is significant and has to be allowed for in risk calculation and counseling
- True. This is conditional information that can be built into a Bayes' calculation
- False. This is a key individual whose risk must be calculated before the consultand's risk

**4. In autosomal recessive inheritance the risk that the nephew of an affected individual, born to the affected individual's healthy sibling, is a carrier is:**

- False.
- False.
- False.
- True. The healthy sibling of the affected individual has a two in three chance of being a carrier; this person's son has a risk which is half of that
- False.

**5. Risk-modifying information:**

- True. For example, negative mutation findings when testing for cystic fibrosis
- True. Age of onset (clinical expression) data must be derived from large family studies
- False. Without this information huge errors will be made
- True. An empiric risk is really a compromise figure and may not apply to a particular situation
- False. It may matter a lot because it is a measure of the likelihood that a meiotic recombination event will take place between the marker and the gene mutation causing the disease

## CHAPTER 9: Developmental Genetics

**1. In development, HOX genes:**

- True. They are important in spatial determination and patterning
- False. Only a few malformation syndromes can be directly attributed to HOX gene mutations at present, probably because of paralogous compensation
- False. They contain an important conserved homeobox of 180 bp
- True. They are probably important only in early development
- True. Where malformation-causing mutations have been identified, different organ systems may be involved, e.g., the hand-foot-genital syndrome (HOXA13)

**2. In the embryo and fetus:**

- False. This occurs later and is the process of laying down the primary body axis in the second and third weeks
- False. Organogenesis takes places mainly between 4 and 18 weeks' gestation
- True. The genes in these pathways are expressed widely throughout the body
- False. Somites form in a rostro-caudal direction
- True. When mutated these genes lead to the ulnar-mammary syndrome and Holt-Oram syndrome

**3. Concerning development pathways and processes:**

- False. It is formed from the first pharyngeal (branchial) arch
- True. Remodeling occurs so that these vessels become the great arteries
- True. This has been established in animals and is proving to be highly likely in humans
- False. Most cases of achondroplasia are due to one particular mutation, G380R at nucleotide 1138 of the FGFR3 gene, and only occasionally other mutations affecting the membrane-bound part of the protein
- False. These different types of mutation usually cause widely differing phenotypes (e.g., the RET gene)

**4. Regarding the X-chromosome:**

- True. Sometimes the SRY gene is involved in recombination with the pseudoautosomal regions of X and Y
- False. Not all regions of the X are switched off; otherwise there would presumably be no phenotypic effects in Turner syndrome
- True. However, only when there is a pathogenic mutation or variant on one X chromosome does this have any consequences
- False. SRY has an important initiating function, but other genes are very important
- True. Some unusual phenomena occur in twins leading to the conclusion that these processes may be linked

**5. Transcription factors:**

- False. They are usually proteins that bind to specific regulatory DNA sequences
- False. They also switch genes on
- True. For example, a leg might develop in place of an antenna
- False. Transcription factors are crucial to normal laterality
- True. The zinc finger motif encodes a finger-like projection of amino acids that forms a complex with a zinc ion

## CHAPTER 10: Common Disease, Polygenic and Multifactorial Genetics

### 1. Concerning autism:

- False.** It is a neurodevelopmental disorder and no metabolic abnormalities are found
- False.** This would imply autosomal dominant inheritance. The rate is about 20%
- False.** Although autism occurs in fragile X syndrome the vast majority of affected individuals do not have this condition
- True.** The figure is nearly 3% for full-blown autism and a further 3% for milder features—autistic spectrum disorder
- False.** The male:female ratio is approximately 4:1

### 2. Linkage analysis is more difficult in multifactorial conditions than in single-gene disorders because:

- True.** Detection of polygenes with small effects is very difficult
- True.** In a fully penetrant single-gene disorder, it is easier to find families with sufficient informative meioses
- True.** Parametric linkage analysis requires that the mode of inheritance is known
- True.** Different genetic and environmental factors may be involved
- True.** The late age of onset means that affection status may be uncertain

### 3. Association studies:

- True.** The disease and variant tested may be common in a population subset but there is no causal relationship
- True.** The TDT test uses family controls and thus avoids population stratification effects
- True.** Replication of positive studies in different populations will increase the evidence for an association
- False.** Association studies are used to test variants identified by gene mapping techniques, including affected sibling-pair analysis
- True.** Variants with small effects may be missed if the patients and controls are not closely matched

### 4. Variants in genes that confer susceptibility to type 2 diabetes (T2DM) have been found:

- True.** The calpain-10 gene was identified by positional cloning in Mexican-American sibling pairs
- False.** No confirmed T2DM susceptibility genes have been identified by this approach
- True.** Examples include two subtypes of maturity-onset diabetes of the young (MODY)
- True.** The genes encoding the potassium channel subunits in the pancreatic  $\beta$ -cell were biological candidates
- True.** For example, the *HNF-1A* variant G319S has been reported only in the Oji Cree population

### 5. Variants in the *NOD2/CARD15* gene:

- False.** Evidence to date supports a role in Crohn disease, but not ulcerative colitis
- True.** Increased risk is estimated at 40-fold for homozygotes and 2.5-fold for heterozygotes
- True.** A genome-wide scan for inflammatory bowel disease (IBD) initially identified the 16p12 region
- False.** The *NOD2/CARD15* gene activates NF- $\kappa$ B, but this complex is already targeted by the most effective drugs used to treat Crohn disease
- False.** The three reported variants are found at a frequency of 5% in the general population, compared with 15% in patients with Crohn disease

## CHAPTER 11: Screening for Genetic Disease

### 1.

- True.** By looking for evidence of two populations of cells
- True.** Firm clinical signs are the exception rather than the rule
- False.** DNA sequence variants must be polymorphic to be useful
- False.** Screening should be in the newborn period and treated early to help ensure good speech development
- True.** As a general rule this may be vital, but should be undertaken with informed consent

### 2.

- False.** The facial rash of angiokeratoma (adenoma sebaceum) is often not present
- False.** There may not be sufficient numbers of café-au-lait spots until age 5 to 6 years
- False.** They may be fully informative of an individual's genetic status
- True.** Dural ectasia of the lumbar spine is an important feature
- False.** Linked DNA markers, and sometimes biochemical tests, may be the only available methods in some circumstances

### 3.

- False.** Participation should, in principle, be voluntary
- True.** The outcome of population screening programs should be an improvement in health benefit
- False.** This is the specificity of a test
- True.** This is different from the sensitivity, which refers to the proportion of affected cases that are detected (i.e., there may be some false negatives)
- True.** Adequate expert counseling should be part of the predictive test program

### 4.

- True.** Recall of the result itself, or the interpretation, is frequently inaccurate
- False.** The highest incidence for a serious disease is that in  $\beta$ -thalassemia: 1 in 8 are carriers
- False.** This has happened before and should be a major concern
- False.** The benefit lies in informing the family for subsequent reproductive decisions
- False.** The first assay is biochemical, a measure of immuno-reactive trypsin

- 5.
- False.** Although the carrier frequency is about 1 in 10, no population screening is undertaken in the United Kingdom
  - False.** In general, unless a beneficial medical intervention can be offered, such testing should be deferred until the child is old enough to make the decision
  - True.** They have been operational since the 1960s and '70s
  - True.** This is one of the newer tests introduced to the program
  - False.** Their prime function in a service department is for clinical management of patients and families

## CHAPTER 12: Hemoglobin and the Hemoglobinopathies

### 1. For different hemoglobins:

- False.** The  $\gamma$  chain of HbF bears a close resemblance to the adult  $\beta$  chain, differing by 39 amino acids
- False.** This is true for the  $\alpha$  and  $\gamma$  chains only; the  $\beta$  chain appears toward the end of fetal life
- False.** There are too few  $\alpha$  chains, which are replaced by  $\beta$  chains
- False.** It is a form of  $\alpha$ -thalassemia
- False.** They have a mild anemia and clinical symptoms are rare

### 2. Regarding sickle-cell disease:

- False.** The effect is due to reduced solubility and polymerization
- True.** Obstruction of arteries can be the result of sickling crises
- True.** A valine residue is substituted for a glutamic acid residue
- False.** Life-threatening sepsis can result from splenic infarction
- True.** These mutations give rise to an amino acid substitution

### 3. Concerning hemoglobin variants:

- True.** This applies to the majority of those known
- False.** All types of mutation are known
- False.** Bone marrow hyperplasia occurs, which leads to physical changes such as a thickened calvarium
- True.** Oxygen is not released so readily to tissues
- True.** HbH, for example, is unstable

### 4. Regarding hemoglobins during life:

- False.** It is a hereditary condition
- False.** This is true only between 2 and 7 months' gestation
- False.** The bone marrow starts producing Hb from 6 to 7 months of fetal life
- False.** Production ceases from 2 to 3 months of postnatal life
- True.** It gives rise to no symptoms—the Hb chains produced are normal

## CHAPTER 13: Immunogenetics

### 1. Concerning complement:

- False.** The cascade can also be activated by the alternative pathway
- True.** C4 levels are reduced and production of C2b is uncontrolled
- False.** C3 levels are normal, C4 levels are reduced
- True.** C3b adheres to the surface of microorganisms
- False.** Complement is a series of at least 20 interacting plasma proteins

### 2. In immunology:

- False.** It is made up of four polypeptide chains—two 'light' and two 'heavy'
- False.** They are distributed on different chromosomes
- False.** Donors are likely to share HLA haplotypes, which are crucial to tissue compatibility
- True.** These are variable, junctional, and constant regions
- True.** Antigen receptors contain two immunoglobulin-like domains

### 3. In immunity and immunological disease:

- False.** They are protected for only 3 to 6 months
- False.** X-linked SCID is 50% to 60% of the total
- True.** B-cell positive SCID due to JAK3 deficiency can be subclinical
- True.** A defect in either T-cell function or development
- False.** CGD is an X-linked disorder of cell-mediated immunity

### 4. In common immunological conditions:

- False.** It is classed as a secondary or associated immunodeficiency
- True.** Immunodeficiency is usually mild and the immune system improves with age as the thymus grows; there is a proneness to viral infections in childhood
- False.** The causes of common variable immunodeficiency are poorly understood and it is often a disorder of adult life
- False.** The risk to first-degree relatives is increased but the pedigree pattern is more suggestive of multifactorial inheritance
- True.** Failure to thrive may be the only clue to an immunodeficiency disorder

## CHAPTER 14: The Genetics of Cancer ... and Cancer Genetics

### 1. Relating to genetic mechanisms leading to cancer:

- True.** The best known example is chronic myeloid leukemia and the Philadelphia chromosome
- False.** Tumor suppressor genes are more common than oncogenes
- True.** Apoptosis is normal programmed cell death
- False.** LOH refers to the presence of two defective alleles in a tumor suppressor gene
- False.** Although important, APC mutations are part of a sequence of genetic changes leading to colonic cancer

**2. In familial cancer syndromes (1):**

- a. **True.** The paradigm was retinoblastoma and the hypothesis was subsequently proved to be correct
- b. **False.** Mutations in *TP53* are found in many cancers, but are germline in Li-Fraumeni syndrome
- c. **False.** It is implicated in MEN-2, but not MEN-1
- d. **True.** There is a significant risk of small bowel polyps and duodenal cancer
- e. **True.** Women with this condition have a lifetime risk of up to 50%

**3. In familial cancer syndromes (2):**

- a. **True.** This syndrome is allelic with Cowden disease, in which papillary thyroid cancer can occur
- b. **True.** The lifetime risk may be in the region of 16%
- c. **False.** The *BRCA1* and *BRCA2* genes do not account for all familial breast cancer
- d. **False.** The lifetime risk of breast cancer for female *BRCA1* or *BRCA2* carriers is 60% to 85%
- e. **False.** The figure is approximately 15%

**4. In familial cancer syndromes (3):**

- a. **False.** Cerebellar hemangioblastoma is a common tumor in VHL
- b. **False.** This tumor is seen in MEN-2 and VHL disease
- c. **True.** There is also an increased risk in familial breast cancer
- d. **True.** Melanin spots in Peutz-Jeghers syndrome, basal cell carcinomas in Gorlin syndrome, and skin tumors in the Muir-Torré form of Lynch syndrome
- e. **False.** The figure is approximately one-third

**5. In cancer prevention and screening:**

- a. **True.** Clear cell renal carcinoma is a significant risk in VHL
- b. **False.** It is easier to detect breast cancer by mammography in postmenopausal women
- c. **False.** It should begin at birth
- d. **False.** Screening is advised in several family history scenarios which do not meet the Amsterdam criteria
- e. **False.** It is strongly indicated in FAP, but not in women positive for *BRCA1* mutations

## CHAPTER 15: Pharmacogenetics, Personalized Medicine and the Treatment of Genetic Disease

**1. Thiopurine drugs used to treat leukemia:**

- a. **True.**
- b. **True.** They are used to treat autoimmune disorders and to prevent rejection of organ transplants
- c. **False.** They can be toxic in 10% to 15% of patients
- d. **True.** These include leukopenia and severe liver damage
- e. **True.** Variants in the *TPMT* gene are associated with thiopurine toxicity

**2. Liver enzymes that show genetic variation of expression and hence influence the response to drugs include:**

- a. **True.** Complete deficiency of this enzyme causes type I Crigler-Najjar disease
- b. **False.** N-acetyltransferase (*NAT2*) variation influences the metabolism of isoniazid
- c. **False.** Absence of *ALDH2* (acetaldehyde dehydrogenase) is associated with an acute flushing response to alcohol
- d. **True.** Approximately 5% to 10% of the European population are poor metabolizers of debrisoquine because of a homozygous variant in the *CYP2D6* gene
- e. **True.** *CYP2C9* variants are associated with decreased metabolism of warfarin

**3. Examples of diseases in which treatment may be influenced by pharmacogenetics include:**

- a. **False.** Patients with glucokinase mutations are usually treated with diet alone
- b. **True.** Patients with *HNF-1A* mutations are sensitive to sulfonylureas
- c. **True.** Abacavir is an effective drug but approximately 5% of patients show potentially fatal hypersensitivity
- d. **True.** Some patients show adverse reactions to the drug felbamate
- e. **True.** Slow inactivators of isoniazid are more likely to suffer side effects

**4. Methods currently used to treat genetic disease include:**

- a. **False.** Germ-cell gene therapy is considered unacceptable because of the risk of transmitting genetic changes to future generations
- b. **True.** For example, bone marrow transplantation is used to treat various inherited immunodeficiencies
- c. **True.** Examples include the replacement of factor VIII or IX in patients with hemophilia
- d. **True.** For example, restricted phenylalanine in patients with phenylketonuria
- e. **False.** This potential treatment has been tested in animal models

**5. Gene therapy may be delivered by:**

- a. **True.** Liposomes are widely used as they are safe and can facilitate transfer of large genes
- b. **True.** *CFTR* gene therapy trials have used adeno-associated viral vectors
- c. **False.** Antisense oligonucleotides need to be delivered to the target cells
- d. **True.** Lentiviruses may be useful for delivery of genes to non-dividing cells
- e. **True.** An example is the injection of plasmid-borne factor IX into fibroblasts from patients with hemophilia B

**6. Gene therapy has been used successfully to treat patients with the following diseases:**

- False.** Trials have shown safe delivery of the *CFTR* gene to the nasal passages but truly effective treatment of cystic fibrosis has not yet been demonstrated
- True.** A number of patients have been treated successfully, although concern was raised when two boys developed leukemia
- False.** This will be difficult because the number of  $\alpha$ - and  $\beta$ -globin chains must be equal or a thalassemia phenotype might result
- True.** Some patients have been able to reduce their exogenous clotting factors
- True.** Although early attempts were unsuccessful, two patients have now been treated successfully by ex-vivo gene transfer

**7. Potential gene therapy methods for cancer include:**

- True.** An example is the protein kinase inhibitor used to treat chronic myeloid leukemia
- True.** Perhaps through overexpression of interleukins
- False.** Anti-angiogenic factors might be used to reduce blood supply to tumors
- True.** RNA interference is a promising new technique that can be used to target overexpressed genes associated with cancers
- True.** A number of trials are ongoing to determine the utility of this technique

**CHAPTER 16: Congenital Abnormalities, Dysmorphic Syndromes, and Learning Disability**

- False.** The figure is approximately 25%
  - True.** This is the figure from chromosome studies. It might be much higher if all lethal single-gene abnormalities could be included
  - False.** The figure is 2–3%
  - False.** This is an example of deformation
  - True.** ‘Sequence’ implies a cascade of events traced to a single abnormality
- False.** Syndrome is correct because of the highly recognizable nature of the condition
  - False.** It has been found to be due to mutations in a single gene, *NSD1*
  - True.** The figure varies between populations and is lowered by periconceptional folic acid intake
  - False.** This well-defined entity is an autosomal recessive condition
  - True.** It may be chromosomal, autosomal dominant, and autosomal recessive

- True.** A teratogen represents a chemical or toxic disruption
  - True.** Renal agenesis causes oligohydramnios, which leads to talipes through deformation
  - False.** A significant increase in various limb defects occurs
  - True.** There is a generalized effect on a particular tissue, such as bone or skin
  - False.** The figure is much higher, at approximately 50%

**4. Relating to maternal influences on fetal development:**

- True.** Deafness and various visual defects are features
- False.** The first trimester is much more dangerous
- True.** Vertebral defects at any level are possible, including sacral agenesis
- False.** This is true for some populations, not all
- True.** Peripheral pulmonary artery stenosis in the case of congenital rubella

**5. In conditions that are often non-mendelian:**

- True.** The incidence is between 1 in 500 and 1 in 1000
- False.** Low recurrence risk because they are thought not to be genetic in many cases
- False.** Large studies of many families are required
- True.** Smith-Lemli-Opitz syndrome is a defect of cholesterol metabolism, affecting the Sonic hedgehog pathway
- False.** The figure is up to 10 cases per 1000

**CHAPTER 17: Chromosome Disorders**

**1. Relating to aneuploidies:**

- True.** Chromosome number was identified in 1956, DNA structure in 1953
- True.** A wide variety of abnormal karyotypes occur in spontaneous abortuses but 45,X is the single most common one
- False.** It is estimated that 80% of all Down syndrome fetuses are lost spontaneously
- True.** Although the risk of Down syndrome increases with maternal age, the large proportion of babies born to younger mothers means that most Down syndrome babies are born to this group
- False.** A small proportion has an IQ at the lower end of the normal range

**2. Relating to common chromosomal disorders:**

- False.** Such children usually die within days or weeks of birth
- False.** Males with Klinefelter syndrome (47,XXY) are usually infertile
- True.** This accounts for a substantial proportion of cases
- False.** This is not seen in either uniparental disomy or imprinting center defect cases
- True.** The deletion on 22q11.2 is a 3Mb region flanked by very similar DNA sequences

**3. In microdeletion conditions:**

- a. **True.** Probably because of haploinsufficiency for elastin
- b. **False.** Congenital heart disease is not a recognized feature of Prader-Willi syndrome
- c. **False.** Chromosome 11p13, and may be a feature of WAGR and Beckwith-Wiedemann syndrome
- d. **True.** A mutation in *PAX6* or a deletion encompassing this locus at 11p15
- e. **True.** Behavioral phenotypes can be very informative (e.g., Smith-Magenis syndrome)

**4.**

- a. **False.** The figure is approximately 1 in 1000
- b. **False.** IQ is reduced by 10 to 20 points but learning difficulties are not a feature
- c. **True.** The other cell line may be normal but could also contain Y-chromosome material
- d. **False.** They have normal fertility
- e. **True.** This occurs because of DNA instability

**5.**

- a. **True.** The mutation passes from a normal transmitting male to his daughters essentially unchanged
- b. **False.** In addition to *FRAXA*, there is also *FRAXE* and *FRAXF*, though they are rare
- c. **True.** Androgen insensitivity syndrome can present in this way
- d. **False.** This is unreliable. DNA analysis is necessary
- e. **False.** The figure is around 10% to 15%

**CHAPTER 18: Inborn Errors of Metabolism****1. In congenital adrenal hyperplasia (CAH):**

- a. **True.** The most common enzyme defect is 21-hydroxylase deficiency
- b. **True.** This occurs in the rare forms: 3 $\beta$ -dehydrogenase, 5 $\alpha$ -reductase, and desmolase deficiencies
- c. **True.** Hyponatremia and hyperkalemia may be severe and lead to circulatory collapse
- d. **False.** Cortisol and fludrocortisone are required lifelong in salt-losing CAH
- e. **False.** Fertility is reduced in the salt-losing form

**2. Phenylketonuria:**

- a. **False.** There is a benign form as well as abnormalities of cofactor synthesis
- b. **False.** Dietary restriction of phenylalanine is necessary only during childhood and pregnancy
- c. **True.** These are features if untreated
- d. **True.** Affected individuals have reduced pigment and are fair
- e. **False.** A different pathway

**3. Hepatomegaly is an important feature of:**

- a. **True.** Hepatomegaly is a feature of most of the mucopolysaccharidoses
- b. **True.** Hepatomegaly is a feature of most of the glycogen storage disorders, although not all
- c. **False.** This is not a feature, even in the so-called hepatic porphyrias
- d. **True.** This is one of the sphingolipidoses—lipid storage diseases
- e. **False.** Cirrhosis can occur in the untreated

**4. Concerning mitochondrial disorders:**

- a. **False.** The main patterns of inheritance also apply where mitochondrial proteins are encoded by nuclear genes
- b. **True.** Especially in *NARP* and *MIDD*, respectively
- c. **True.** There are 37 gene products
- d. **False.** Leigh disease is genetically heterogeneous
- e. **True.** The *G4.5* gene is mutated, urinary 3-methylglutamic acid is raised, but the link remains to be elucidated

**5. Regarding metabolic conditions:**

- a. **True.** The carnitine cycle is important for long-chain fatty acid transport into mitochondria
- b. **True.** 90% of alleles are due to the same mutation and neonatal population screening has been suggested
- c. **False.** These are inborn errors of copper transport metabolism
- d. **True.** These features should prompt investigation for organic acidurias and mitochondrial disorders, among others
- e. **False.** Important radiological features may be seen in peroxisomal and storage disorders

**CHAPTER 19: Mainstream Monogenic Disorders****1. Huntington disease:**

- a. **False.** Meiotic instability is greater in spermatogenesis than in oogenesis
- b. **True.** This has been shown from studies in Venezuela
- c. **False.** The duration is approximately 15 to 20 years
- d. **True.** This is so for the reduced penetrance alleles of 36 to 39 repeats
- e. **False.** Some degree of cognitive impairment may be part of the early symptomatic phase of HD but dementia is a later development

**2. Myotonic dystrophy:**

- a. **False.** Somnolence is common
- b. **False.** Neonatal hypotonia
- c. **True.** Through a CUG RNA-binding protein, which interferes with a variety of genes
- d. **True.** An important feature of myotonic dystrophy and the defining abnormality of many channelopathies
- e. **False.** Myotonic dystrophy type 2 is due to a 4-base pair repeating element, (CCTG)<sub>n</sub>

**3.**

- a. **False.** The Phe508del mutation is the most common
- b. **True.** The polythymidine tract—5T, 7T, and 9T—can be correlated with different CF phenotypes
- c. **False.** This is true for most of the inherited cardiac arrhythmias; cardiomyopathies are often from defects in sarcomeric muscle proteins
- d. **True.** This glycoprotein complex in the muscle membrane contains a variety of units; defects in these cause various limb-girdle dystrophies
- e. **False.** These patients have normal intelligence

4.
  - a. **False.** They are good candidates according to current thinking
  - b. **False.** It is only a component of the skeletal system criteria
  - c. **False.** It is thought to be a fully penetrant disorder
  - d. **True.** This is not usually severe but is a recognized feature
  - e. **False.** The opposite is the case

**5. In neuromuscular conditions:**

- a. **False.** This is a neurophysiological classification
- b. **True.** Autosomal dominant, autosomal recessive, and X-linked
- c. **True.** Mutations in the peripheral myelin protein affect Schwann cells
- d. **False.** They are not good discriminatory tests and DNA analysis should be performed
- e. **False.** It is an inherited cardiac arrhythmia

## CHAPTER 20: Prenatal Testing and Reproductive Genetics

**1. In prenatal testing:**

- a. **False.** It is still mainly performed around 16 weeks' gestation
- b. **False.** They also derive from the amnion and fetal urinary tract epithelium
- c. **False.** There is a small risk of causing limb abnormalities; CVS should not be performed before 11 weeks' gestation
- d. **False.** There is a small but significant risk of a different karyotype due to confined placental mosaicism
- e. **False.** Fetal anomaly scanning is normally performed around 20 weeks' gestation because earlier scanning is not sufficiently sensitive

**2. Regarding prenatal markers:**

- a. **True.** This forms part of the triple test
- b. **True.** This forms part of the triple test
- c. **False.** In trisomy 18 all maternal serum markers are low
- d. **False.** The best figure achieved is approximately 86%
- e. **True.** There are two fetuses rather than one

**3.**

- a. **False.** The accuracy is greater than 99%
- b. **True.** Especially aneuploidies
- c. **True.** Probably because of the presence of inspissated meconium
- d. **True.** Most cases of Down syndrome are due to meiotic non-disjunction
- e. **True.** They are unlikely to have different clinical effects in different members of the same family

**4. In assisted reproduction:**

- a. **False.** A license from the HFEA is required
- b. **False.** It is not illegal but does require an HFEA license
- c. **True.** This is undertaken to avoid the presence of extraneous sperm
- d. **False.** The figure is about 25% to 30%
- e. **False.** Chromosome disorders are the largest group

**5.**

- a. **True.** Chromosome abnormalities are present in 10% to 12% of men with azoospermia or severe oligospermia, some of them heritable
- b. **False.** The rule is that no more than 10 pregnancies may result from one donor
- c. **False.** They are entitled to know the identity of their donor parent but only when they reach the age of 18
- d. **False.** NIPT will have increasing applications but will not totally replace other methods, e.g. ultrasound
- e. **False.** The figure is approximately 1 in 7

## CHAPTER 21: Genetic Counseling

**1.**

- a. **False.** This is the consultand, the proband is the affected individual
- b. **False.** Retinitis pigmentosa can follow all the main patterns of inheritance
- c. **False.** It is far more—transfer of relevant information, presentation of options, and facilitation of decision making in the face of difficult choices
- d. **False.** Non-directive counseling is the aim because patients/clients should be making their own decisions
- e. **True.** Patients do not remember risk information accurately and there are other important measures of patient satisfaction

**2.**

- a. **False.** The risk is approximately twice the background risk
- b. **True.** This is a second-degree relationship
- c. **False.** The risk is roughly 25%
- d. **False.** It is perfectly normal in many societies
- e. **False.** It refers to anything from, for example, uncle-niece partnerships (second degree) to third cousins (seventh degree)

**3.**

- a. **False.** Guilt feelings from parents and grandparents are common when a genetic disease is first diagnosed in a child
- b. **False.** Many patients make the choice they would have made before genetic counseling—but after the counseling they should be much better informed
- c. **True.** The risk from each grandparent is 1 in 64
- d. **False.** Such a practice is strongly discouraged and the indications for genetic testing should be the same
- e. **False.** Good patient support groups have a huge role, and the patients/families themselves become the experts for their condition



# Case-Based Answers

## CHAPTER 6: Patterns of Inheritance

### Case 1

1. It is possible that the problems described in family members are unrelated, but this is unlikely. If the condition has passed from the maternal grandfather, it is either autosomal dominant with variability, or X-linked. It is necessary to consider both possibilities because this will affect genetic counseling and may determine which genetic tests are undertaken.
2. The spinocerebellar ataxias are a genetically heterogeneous group of conditions that usually follow autosomal dominant inheritance and could present in this way. A form of hereditary spastic paraparesis is possible, also genetically heterogeneous but usually follows autosomal dominant inheritance, although recessive and X-linked forms are described. Apart from these, X-linked adrenoleukodystrophy must be considered, especially because the man has signs of cognitive and behavioral problems. This is very important, not only because it can present early in life but also because of the potential for adrenal insufficiency.

### Case 2

1. Apart from detailed family history information, it is routine in cases of congenital sensorineural hearing loss (SNHL) to explore the possibility of congenital infection (which may be impossible in adults after this passage of time), undertake eye (Usher syndrome) and cardiac (Jervell and Lange-Nielsen syndrome) investigations, perform MRI scan of the inner ear (Pendred syndrome) and parental audiograms.
2. It is likely that *she* has autosomal recessive SNHL, given that she has an affected brother; *he* may also have autosomal recessive SNHL, in which case their children may have a 100% chance of inheriting SNHL, or a very low chance because their deafness is probably due to mutations in different genes. However, it is also possible that he has X-linked recessive deafness with the associated consequences for their children and grandchildren through daughters.

### Case 3

1. The information *may* be correct but, given the clinical diagnosis of osteogenesis imperfecta, it is probably not and other possibilities must be considered and explained to them.
2. Most forms of osteogenesis imperfecta (brittle bone disease) follow autosomal dominant inheritance, though there are rare forms that follow autosomal recessive inheritance. Sibling recurrence, when neither parent has signs or symptoms, can be explained by somatic and/or germline mosaicism in one of the parents. The risk to the offspring of those affected would then be 50% (i.e., high). It is also important

in such cases to consider the possibility of a non-genetic diagnosis, namely non-accidental injury. Confirmation of the diagnosis is therefore important.

## CHAPTER 7: Population and Mathematical Genetics

### Case 1

1. Clearly, it is essential to know whether the condition in question has ever knowingly occurred in the families of either of the two consultands. If this had occurred, it would potentially modify the carrier risk for one of the consultands regardless of the frequency of the disease in their population.
2. Assuming the disorder in question has not occurred previously in the family, the carrier frequency in population A is 1 in 50, and in population B 1 in 15. The risk in the first pregnancy is therefore  $1/50 \times 1/15 \times 1/4 = 1/3000$ .

### Case 2

1. From the figures given, four cases in the town appear to be new mutations, i.e., four new mutations per 100,000 genes inherited. The mutation rate is therefore 1 per 25,000 gametes.
2. New mutation rates should be based on birth *incidence* rather than population *prevalence*. The population sample is relatively small and there may be ascertainment bias. For example, if there is bias toward an older, retired population, the proportion that is reproductively active may be small and the figures distorted by the migration of younger people away from the town. In addition, the four 'new mutation' cases should be verified by proper examination of the parents.

## CHAPTER 8: Risk Calculation

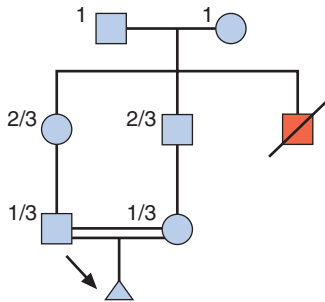
### Case 1

1. Each of the siblings of the affected aunt has a chance of being a carrier; therefore, each of the cousins has a chance of being a carrier. The chance of the couple's first baby being affected is  $1/3 \times 1/3 \times 1/4 = 1/36$ .
2. Even though genetic studies cannot be performed directly on the deceased individual, DNA analysis can be offered to other family members in an attempt to identify the causative mutations for Hurler syndrome. If there is any doubt about the original diagnosis it might also be worth looking for the mutations of Hunter syndrome, which closely resembles Hurler syndrome, though is X-linked. If

**Table 1**

Probability	Is a Carrier	Is Not a Carrier
Prior	1/2	1/2
Conditional (2 normal sons)	$1/2 \times 1/2$	1
Joint	1/2	1/2
Posterior	$1/8 / (1/8 + 1/2) = 1/5$	

there are uncertainties about the results biochemical prenatal testing for Hurler syndrome can be offered for their pregnancies (not Hunter syndrome because this family structure means the fetus is not at risk of X-linked Hunter syndrome).

**Case 2**

1. A simple Bayes' calculation can be performed, taking into account that she has had two normal sons (Table 1). She therefore has a 1/5, or 20%, chance of being a carrier.
2. There is a good chance of identifying the factor VIII gene mutation in either her brother or uncle if either of them is still alive. If so, it should then be possible to determine her carrier status definitively. If not, mutation analysis can be offered to her, as well as tests of factor VIII levels and factor VIII-related antigen, though the latter tests are not necessarily discriminatory. DNA linkage analysis could also be attempted if appropriate DNA samples are available, including those of her unaffected sons.

**CHAPTER 9: Developmental Genetics****Case 1**

1. The combination of macrocephaly, odontogenic keratocysts, and basal cell carcinomas occurs in Gorlin (basal cell nevoid carcinoma) syndrome. It is understandable that hydrocephalus would be the main concern, but true hydrocephalus is unusual in Gorlin syndrome. This condition should be in the differential diagnosis of a child with macrocephaly, with appropriate exploration of the family history. Other macrocephaly conditions to consider are Sotos syndrome and Cowden syndrome but neither of these includes odontogenic keratocysts.
2. The child's father is an obligate carrier for the *PTCH* gene mutation causing Gorlin syndrome in the family. He should be screened regularly (at least annually) by radiography for odontogenic keratocysts, and be under regular surveillance by a dermatologist for basal cell carcinomas. Assuming a *PTCH* gene mutation is identified, predictive testing should

be offered to at-risk family members who wish to clarify their status.

**Case 2**

1. This combination of anomalies strongly suggests one of the ciliopathy conditions, of which a wide range is now known. They arise due to defective cilia which are ubiquitous on cell surfaces and crucial for normal development. They almost all follow autosomal recessive inheritance.
2. The findings on ultrasound do not necessarily distinguish one of the more severe short-rib polydactyly syndromes from Jeune's asphyxiating thoracic dystrophy or Ellis-van Crefeld syndrome. Detailed ultrasound examination of the fetal heart is indicated as well as serial measurements of the chest size because of the postnatal risk of respiratory insufficiency. Urogenital structures should be carefully evaluated.

**Case 3**

1. The two most likely causes of sex reversal in a young 'girl' are androgen insensitivity syndrome (AIS), which is X-linked and results from mutations in the androgen receptor (*AR*) gene, and mutations in the *SRY* gene on the Y chromosome.
2. Mutation analysis in both the *AR* and *SRY* genes can be performed to determine the genetic basis of the sex reversal. It is very important to investigate and locate, if present, remnants of gonadal tissue because this will have to be removed to avoid the risk of malignant change. Because of this, the parents should be given a full explanation, but the phenotypic sex of the child should be affirmed as female.

**CHAPTER 10: Common Disease, Polygenic and Multifactorial Genetics****Case 1**

1. Testing for factor V Leiden and the prothrombin G20210A variant is appropriate. A positive result would provide a more accurate risk of her developing thromboembolism and would inform her choice of contraception. Heterozygosity for factor V Leiden or the prothrombin G20210A variant would increase her risk by four- to five-fold. Homozygosity or compound heterozygosity would increase her risk by up to 80-fold.
2. Negative results for factor V Leiden and the prothrombin 20210A variant in the consultand should be interpreted with caution as up to 50% of cases of venous thrombosis are not associated with these genetic risk factors.

**Case 2**

1. The proband might have type 1 diabetes (T1DM), type 2 diabetes (T2DM), or maturity-onset diabetes of the young (MODY). Because both have normal hearing, a diagnosis of maternally inherited diabetes and deafness (mitochondrial) is unlikely. T1DM and T2DM show multifactorial inheritance with environmental factors playing a role in addition to predisposing genetic susceptibility factors. MODY shows autosomal dominant inheritance.
2. The brother's risk of developing diabetes is 6%, 35%, or 50%, respectively. If his sister is found to have a mutation in one of the genes causing MODY, he could then opt for predictive genetic testing. A negative test would reduce his risk to that of the population. A positive test would allow

regular monitoring in order to make an early diagnosis of diabetes and avoid diabetic complications from long-standing undiagnosed diabetes.

### Case 3

1. Generally, the risk of epilepsy to first-degree relatives is around 4%. However, mother and daughter are affected here, which suggests the possibility of a Mendelian form of epilepsy. Furthermore, it seems that both have an abnormal finding on brain imaging and the mother's computed tomograms should be located and reviewed by an expert neuroradiologist. At this stage, an explanation of both autosomal dominant and X-linked inheritance is appropriate, as well as the possibility that the two cases of epilepsy are coincidental.
2. The condition that the mother's doctors mentioned would almost certainly have been tuberous sclerosis (TS), which follows autosomal dominant inheritance. Further evaluation of both mother and daughter looking for clinical features of TS might be indicated and genetic testing has a high chance of finding a mutation. However, the nodules on the lateral ventricle walls may be pathognomonic of bilateral periventricular nodular heterotopia (BPVNH) and the images should be reviewed by someone who can recognize this. BPVNH is an abnormality of neuronal migration and is inherited as an X-linked dominant condition, caused by mutations in the filamin-A (*FLNA*) gene, for which testing can be offered. In general, Mendelian forms of epilepsy are rare apart from the genetically heterogeneous early infantile epileptic encephalopathies.

### Case 4

1. Not necessarily. Many people with glucokinase gene mutations are asymptomatic and their mild hyperglycemia is detected only upon screening (routine medicals, during pregnancy or intercurrent illness). Gestational diabetes in the father's sister raises the definite possibility that the mutation could have been inherited from his side of the family.
2. Identification of a glucokinase gene is 'good news' because the mild hyperglycemia is likely to be stable throughout life, treated by diet alone (except during pregnancy) and unlikely to result in diabetic complications. Cascade testing can be offered to other relatives. If the mutation has been inherited from the father, his father's sister and her child may be tested. The sister might avoid the anxiety of having a young child diagnosed with unexplained hyperglycemia.

## CHAPTER 11: Screening for Genetic Disease

### Case 1

1. Mutation analysis in the fibrillin-1 (*FBNI*) gene, for Marfan syndrome, is possible for the consultand but not guaranteed to identify a mutation even if the clinical diagnosis is confident—many variants of uncertain significance are reported. In reality, if the family history is negative and the patient does not meet the clinical criteria for a diagnosis, most geneticists would not perform this test. If DNA from the deceased father is available it may be possible to analyze this for a range of known 'aortopathy' genes, but the positive yield is low. Genetic testing in this scenario is unlikely to be helpful.

2. The important life-threatening complication of Marfan syndrome is progressive aortic root dilatation carrying a risk of dissection. Those with a firm diagnosis must be followed until at least the age of 30 years. If there is doubt about the diagnosis, regular cardiac screening is probably a sensible precaution for all those at risk until their mid-20s.

### Case 2

1. The sensitivity is the proportion of true positives detected by the test, i.e.,  $45/50$  (i.e.,  $45 + 5$ ) = 90%. The specificity is the proportion of true negatives detected by the test, i.e.,  $99,190$  (the unaffected cases who test negative)/ $99,190 + 760$  (the unaffected cases who test positive) = 99.2%.
2. The positive predictive value is the proportion of cases with a positive test who truly have the disease, i.e.,  $45/805$  = 5.6%.

## CHAPTER 12: Hemoglobin and the Hemoglobinopathies

### Case 1

1. The ethnic origin of the couple and the limited information should suggest the possibility of a hematological disorder.  $\alpha$ -Thalassemia is the likely cause of stillbirth, hydrops being secondary to heart failure, which in turn is secondary to anemia. Rhesus isoimmunization and glucose-6-phosphate dehydrogenase deficiency are other possibilities. Severe forms of congenital heart disease are frequently associated with hydrops, but the chance of a sibling recurrence (which occurred in the case history) is low, unless there was a recurrence of multiple abnormalities as a result of an unbalanced reciprocal translocation for which one of the parents is a balanced carrier. There are many other causes of recurrent hydrops and these would need to be considered, including rare, lethal skeletal dysplasias and a wide range of metabolic diseases.
2. A full blood count, blood groups, Hb electrophoresis, and maternal autoantibody and glucose-6-phosphate dehydrogenase deficiency screens should be performed for the couple. DNA analysis may detect the common mutation seen in Southeast Asia, which would then make it possible to offer genetic prenatal diagnosis by chorionic villus sampling. If no disorder is identified by these investigations it is unlikely that further diagnostic progress will be made unless the couple has another affected pregnancy that can be fully investigated by examination of the fetus, including genetic testing.

### Case 2

1. This presentation is consistent with acute intermittent porphyria and hemolytic uremic syndrome. However, the ethnic origin should also suggest the possibility of sickle cell disease. The contents of the dark urine, and specific tests for porphyria, will help to differentiate these, and a sickle cell test should be performed.
2. If the diagnosis is sickle cell disease there are various agents that can be tried to reduce the frequency of sickling crises—hydroxyurea in particular. Prophylactic penicillin is important for reducing the risk of serious pneumococcal infections, and the family should be offered genetic counseling and cascade screening of relatives.

**CHAPTER 13: Immunogenetics****Case 1**

1. The nature of his grandfather's symptoms are rather non-specific—back pain and arthritis are both very common in the general population. However, it is certainly *possible* that he also had ankylosing spondylitis, a form of enthesitis (inflammation at the site of insertion of a ligament or tendon into bone) with involvement of synovial joints, as the heritability is greater than 90%.
2. Approximately 95% of patients with ankylosing spondylitis are positive for the HLA-B27 antigen; however, in the general population this test has only a low positive predictive value. His children have a 50% chance of being HLA-B27 positive; if positive, the risk of developing clinical ankylosing spondylitis is approximately 9%; if negative, the risk is less than 1%.

**Case 2**

1. This history, with tetralogy of Fallot, nasal speech (due to a short palate) and neonatal hypocalcemia, points strongly towards a diagnosis of deletion 22q11 (DiGeorge/Sedláčková) syndrome, which can easily be confirmed by microarray-CGH analysis (or specific FISH testing in the past). Immunity is impaired but gradual improvement usually occurs through childhood and adolescence.
2. Deletion 22q11 syndrome can be familial and does not always give rise to congenital heart disease. If confirmed in the child, both parents should be tested for the deletion, and other family members as appropriate. Genetic counseling for the child will be important when she is older.

**CHAPTER 14: The Genetics of Cancer ... and Cancer Genetics****Case 1**

1. The family history should first of all be confirmed with the consent of the affected individuals. If the thyroid cancer in the cousin was papillary in type, and the polyps in her father hamartomatous, the pattern would be very suspicious for Cowden disease. This is also known as PTEN hamartoma tumor syndrome, which is autosomal dominant and usually due to a mutation in the *PTEN* gene; the risk of breast cancer is high—approximately 50% in females.
2. Macrocephaly (head circumference usually above the upper limit of the normal range), a cobblestone appearance of the oral mucosa, and generalized lipomas are other features to look for in patients with this unusual history.

**Case 2**

1. If the *BRCA2* mutation has not been confirmed in another family member or by testing another sample from the deceased cousin (e.g., a tissue section embedded in paraffin), the possibility of a sample mix-up in the research laboratory cannot be excluded. If, however, the uncle tests positive for the mutation, the consultand's mother is a phenocopy. If the consultand's mother and uncle both test negative the mutation was probably inherited from the cousin's mother, but a new mutation event is also a possibility.
2. If the uncle tests positive for the *BRCA2* mutation, then his lifetime risk of developing breast cancer is approximately

6%, more than 100-fold higher than that in the general male population.

**Case 3**

1. The alleged malignancies in relatives should be confirmed in cancer registries if possible. The pattern is consistent with Lynch syndrome but the affected individuals are not connected by first degree relationships. Renal cancer affecting the pelvis is a transitional cell carcinoma. The logical first investigation is microsatellite instability studies of tumor tissue from the proband and/or his cousin with endometrial cancer. Positive findings can be followed up by mutation analysis of the Lynch syndrome mismatch repair genes.
2. Screening to the proband's three children depends on the results of the Lynch syndrome tests in the proband. If a pathogenic mutation is found they can be offered predictive genetic testing. If not, they would probably be offered a one-off colonoscopy at approximately 55 years of age. There is no reliable screening for endometrial cancer.

**CHAPTER 16: Congenital Abnormalities, Dysmorphic Syndromes, and Learning Disability****Case 1**

1. This is not an unusual scenario. The karyotype on amniocentesis was normal and polyhydramnios suggests the possibility of a gastrointestinal obstruction such as esophageal atresia. The abnormalities are more likely to represent an 'association', e.g., VACTERL, rather than a syndrome or Mendelian condition. The empiric recurrence risk is low, and without fetal samples or detailed information that an autopsy may have provided, all that can be offered is ultrasonography in subsequent pregnancies.
2. A fetal autopsy is highly desirable in this situation to know the full extent of internal organ anomalies. Microarray-CGH analysis on fetal skin may have shown something that was not detected on amniocentesis, and DNA should be stored for possible future use—in cases such as this whole exome sequencing may well be performed in the future. Maternal diabetes should be excluded. Parental karyotypes can be analyzed for the possibility of a balanced reciprocal translocation, including telomere screens to look for the possibility of a cryptic translocation.

**Case 2**

1. Isolated, non-syndromic cleft palate is statistically the most likely diagnosis, but the mild short stature might be significant. Syndromic possibilities include spondyloepiphyseal dysplasia (SED)—although there are many rare syndromes with more severe short stature and other features. Mild short stature is a feature of hypochondroplasia, Russell-Silver syndrome, and *SHOX*-associated short stature, for all of which gene tests are available; however, clefting is not usually associated with these disorders.
2. The short stature appears mild; it is, therefore, important to try to determine whether this might be familial—the parents need to be assessed. Follow-up of the baby is indicated, including a radiological skeletal survey to see whether there is an identifiable skeletal dysplasia. SED may be accompanied by myopia and sensorineural hearing

impairment; therefore hearing and vision assessment is important. However, the child has cleft palate and is at risk of conductive hearing problems as a result. The cleft palate team needs to be involved from the beginning.

### Case 3

1. Assuming the 10 year-old girl is an isolated case in the family, it is most likely that she has a new mutation in a learning disability gene, and therefore a low recurrence risk. However, there is a small risk that the condition may be due to autosomal recessive inheritance with a 1 in 4 (25%) recurrence risk. X-linked inheritance is very unlikely given her gender, though a new mutation for an X-linked dominant condition is possible.
2. Cases like this are commonly encountered in clinical practice and remain without a diagnosis on a long term basis. Unless there are clear features of a recognizable syndrome, which would then lead to specific genetic testing, DNA from the child can be analyzed on learning disability gene panels or possibly investigated by a full clinical exome analysis in conjunction with parental DNA.

## CHAPTER 17: Chromosome Disorders

### Case 1

1. Head-banging is not rare in early childhood, especially in children with developmental delay, and it is not necessarily a helpful feature in making a diagnosis. However, combined with the persistently disturbed sleep pattern and unusual hugging behavior, the diagnosis of Smith-Magenis syndrome should be considered. These children can be quiet as babies and have congenital heart disease; later they may develop scoliosis. Melatonin has proved a very effective treatment for sleep disturbance.
2. Smith-Magenis syndrome is usually due to a microdeletion at 17p11.2, which would be detected by microarray-CGH analysis. In cases where this test is negative and the clinical diagnosis is still considered likely, mutation analysis in the critical gene, *RAI1*, should be requested.

### Case 2

1. The previous counseling given naturally assumed the girl was *pure* 47,XXX. However, the subsequent clinical course—short stature—raises the possibility that she has chromosome mosaicism, and in particular she might be mosaic for Turner syndrome (45,X). A buccal smear and/or skin biopsy should be offered to look at chromosomes (QF-PCR or karyotype) in a tissue other than blood. If this is normal, other causes of short stature would need to be considered.
2. If the child is indeed found to be a 45,X/47,XXX mosaic, she needs to be investigated for the complications of Turner syndrome—congenital heart disease and horseshoe kidney. In addition, her fertility is in question and she would need to be referred to a pediatric endocrinologist for appropriate investigations, who would also assess her for possible growth hormone treatment.

### Case 3

1. The 15q11.2 microdeletion is recognized to be associated with neurodevelopmental problems including mild

intellectual disability and behavior disorder. It may therefore be the explanation for the child's problems and possibly those in the household as well. Objectively, however, the finding does not necessarily prove a causal link as some individuals with these recurring microdeletions are entirely normal in terms of intellectual ability and social skills.

2. Testing other family members for the same microdeletion can be offered. The clinical geneticist is investigating whether the microdeletion segregates with intellectual difficulties and behavior disorder in the family. Often, the situation is not as clear cut as one would wish to see in order to draw conclusions; however, if on balance a causal link seems likely then the child will often be more fully supported through the education system.

## CHAPTER 18: Inborn Errors of Metabolism

### Case 1

1. Hypoglycemia can be part of severe illness in young children, but in this case the intercurrent problem appears relatively minor, suggesting that the child's metabolic capacity to cope with stress is compromised. This history should prompt investigations for a possible inborn error of metabolism and, if a diagnosis is made, the younger sibling should be tested.
2. Hypoglycemia is a common consequence of a number of inborn errors of amino acid and organic acid metabolism. Investigation should begin with analysis of urinary organic acids, plasma amino acids, ammonia and liver function tests. If a biochemical diagnosis is reached mutation analysis in the relevant gene(s) should be undertaken.

### Case 2

1. The combination of clinical features—dilated cardiomyopathy and generalized muscle weakness, together with two more distant males in the family with a similar history connected through the female line—could be one of several mitochondrial conditions following mitochondrial inheritance. However, as all affected individuals are male suspicion should be high for Barth syndrome, following X-linked inheritance.
2. Biochemical testing would be likely to show a five- to 20-fold increase in urinary 3-methylglutaconic acid; in addition, neutropenia is common and a cause of mouth ulcers, pneumonia, and sepsis. Mutation analysis of the *G4.5 (TAZ)* gene can be requested, which if positive can be extended to other family members, starting with the mother.

### Case 3

1. If there is a family history of similar symptoms, it might demonstrate matrilinear inheritance with all the offspring of affected males being normal. If this person is the only affected individual, a family history by itself will not be informative with respect to the diagnosis.
2. All causes of myopathy need to be considered, but the combination of features is suggestive of a mitochondrial cytopathy. This would explain the muscular symptoms, ptosis, and hearing impairment—and there might also be evidence of a cardiomyopathy, neurological disturbance, retinitis pigmentosa, and diabetes mellitus. Mitochondrial DNA analysis on peripheral lymphocytes might identify a

mutation, although a negative result would not rule out the diagnosis. A muscle biopsy might show ragged red fibers, and DNA analysis on this tissue might be more informative than lymphocytes. Weakness and ptosis would also be consistent with myotonic dystrophy, though hearing impairment would not be expected. The family history for myotonic dystrophy may show a pattern of autosomal dominant transmission with anticipation.

## CHAPTER 19: Mainstream Monogenic Disorders

### Case 1

1. The history in the brother is consistent with his having Becker muscular dystrophy (BMD) but is also consistent with other diagnostic possibilities, e.g., limb-girdle muscular dystrophy (LGMD). These two conditions have sometimes been difficult to distinguish and the inheritance is different (X-linked for BMD and nearly always autosomal recessive for LGMD), with quite different implications for the woman who wishes to start a family.
2. The medical records of the affected brother should be reviewed and he should be reassessed if possible. Thirty years ago the tests for BMD were very basic (no direct gene tests) but now dystrophin gene mutation analysis is available, which should be the initial investigation along with creatine kinase estimation. In the event that dystrophin gene mutation analysis is difficult to interpret, a muscle biopsy subjected to specific dystrophin staining may be diagnostic, but if this is negative staining techniques for different forms of LGMD are available. If the diagnosis is one of the LGMD group the woman can be reassured because these follow autosomal recessive inheritance and she has a two-thirds chance of being a carrier. If BMD, carrier testing for the consultand would be straightforward if a specific mutation has been found in her brother.

### Case 2

1. The sudden, unexpected death of anyone, especially young adults when no cause can be identified, is extremely shocking for a family. The focus of attention becomes the inherited arrhythmias and cardiomyopathies—sometimes the latter show no obvious features at postmortem examination. All close family members are eligible for cardiac evaluation by echocardiography, ECG, and provocation tests, looking for evidence of the long QT and Brugada syndromes. Genetic testing is available but not guaranteed to identify a pathogenic mutation. Some forms of inherited arrhythmia/cardiomyopathy are amenable to prophylactic treatment.
2. Management will depend on the outcome of investigations and genetic testing—usually gene panel analysis of genes known to be linked to inherited arrhythmias and cardiomyopathies. However, if no positive findings are made it is very difficult to know how to advise families like this. High-intensity sports and swimming should probably be avoided because such activities may be precipitating factors for a life-threatening arrhythmia.

### Case 3

1. Clinical examination should rigorously apply the Ghent or revised Ghent criteria in looking for features of Marfan

syndrome. The family history should be taken into account but the grandfather may have suffered an aortic aneurysm as a consequence of high blood pressure and smoking rather than a genetic predisposition and it is important to try and establish if the aortic aneurysm was thoracic or abdominal. With a high index of suspicion for Marfan syndrome it would be possible to undertake genetic testing of the fibrillin-1 gene, but this should not be done if the clinical criteria are not met because there is a strong possibility that a VUS will be found.

2. Other conditions to be considered include a connective tissue disorder in the Ehlers-Danlos syndrome family, and Loey-Dietz syndrome.

## CHAPTER 20: Prenatal Testing and Reproductive Genetics

### Case 1

1. The finding of mosaicism for trisomy 20 in chorionic villus tissue might have been a case of confined placental mosaicism. The latter is not a rare event for a wide variety of chromosome aberrations but, as long as it is confined, there are no serious consequences for the pregnancy. The problem with going on to perform an amniocentesis is in interpretation of the result. If no abnormal cells are found, this does not completely rule out chromosome mosaicism in the fetus. If abnormal cells are found, the clinical implications are very difficult, if not impossible, to predict.
2. This case illustrates the rollercoaster of emotions and experiences that some women and couples have to cope with as a result of different forms of prenatal tests and their interpretation. In fact, trisomy 20 mosaicism is unlikely to be of great clinical significance—but it is very difficult to be sure. Renal abnormalities have been reported, and detailed fetal anomaly scanning can be offered for the remainder of the pregnancy. However, what might have been an enjoyable pregnancy will probably continue to be an anxious one.

### Case 2

1. In the majority of autism cases, no specific diagnosis is reached. Microarray-CGH, fragile X syndrome testing, a metabolic screen, and examination for neurocutaneous disorders, should all be performed.
2. This is a very difficult situation. However, there is no proof in this case that autism is either truly X-linked or showing a gender bias towards males—the statistics apply to large cohort studies. Therefore, there is no guarantee that any daughter will be unaffected. It would therefore not be possible to support this request in the United Kingdom where PGD is regulated by the Human Fertilization and Embryology Authority, and sex selection for anything other than clearly X-linked conditions is not licensed. In other countries, where these techniques are not regulated, the couple might find clinicians who acquiesce to their request.

### Case 3

1. The test she has been offered is likely to be the non-invasive prenatal test (NIPT) for two investigations on cell-free fetal

DNA: sexing of the fetus and Down syndrome analysis. She is an obligate carrier of hemophilia A if her father was affected, so she wishes to know if her fetus is male. If so, CVS could be performed to know whether she is carrying an affected boy.

2. Sexing of the fetus is highly accurate. NIPT for Down syndrome is also highly accurate in all studies undertaken, greater than 99%. This form of testing presents a clear advantage regarding safety to the pregnancy as well as potentially avoiding an expensive invasive procedure.

## CHAPTER 21: Genetic Counseling

### Case 1

1. The couple is at risk of having further affected children and prenatal diagnosis can be offered. The father may have inherited the balanced translocation from one of his parents and his sister may also be a carrier. Carrier testing should be offered to his family, especially as his sister is trying to get pregnant.
2. The father's wider family needs to be made aware of the child's diagnosis, but have fixed misconceptions and it might

be very difficult for them to accept that the child's problems have their origin on their side of the family. There is a severe communication problem but a way needs to be found to inform the father's wider family of the genetic risk. Involvement of general practitioners and other health professionals, i.e., using an independent and well-informed third party, might help.

### Case 2

1. There is now no need for the woman to undergo an invasive prenatal test in future pregnancies, assuming her partner is the biological father; this would be a waste of resources and place the pregnancy at a small but unnecessary risk of miscarriage.
2. There is the difficulty of communicating the fact that a prenatal test is not necessary, but disclosure of non-paternity may have far-reaching consequences for the couple's relationship. The genetic counselors do not know whether the partner suspects non-paternity, and the mother may believe he is the biological father of the child. In the first instance genetic counselors may try and create an opportunity for the mother to be counselled alone and gently confronted with the results.

# Index

Page numbers followed by “*f*” indicate figures, “*t*” indicate tables, and “*b*” indicate boxes.

- A**
- AATD. *see* Alpha-1 antitrypsin deficiency (AATD)
- ABCC8 gene, 203
- ABO blood groups, 174–175, 174*t*
- ACE inhibitors, teratogenic effects of, 225*t*
- N-Acetyltransferase activity, 201
- Achondroplasia, 113–114, 113*t*, 115*f*
- Acidemia
- methylnalonic, treatment for, 205*t*
  - propionic, treatment for, 205*t*
- Acoustic neuromas, 280. *see also* Vestibular schwannomas
- Acquired diseases
- childhood, that show multifactorial inheritance, 130
  - somatic genetic disease, 5
- Acrodermatitis enteropathica, 268
- Acute intermittent porphyria, 266
- Acute-phase proteins, 165
- Adams, Joseph, 1–2, 4
- Adaptive immunity, 164
- Addition, laws of, 94
- Adeno-associated viruses, 209
- Adenoma sebaceum, 66–68, 68*f*, 281*f*
- Adenomatous polyposis coli (APC) gene, 189–190
- Adenosine deaminase deficiency, 173, 266
- SCID resulting from, treatment for, 205*t*
- Adenoviruses, 209
- Adenylate kinase-2 gene (AK2), 173
- Adenylate residues, 15
- Adoption, 321
- ADPKD. *see* Autosomal dominant polycystic kidney disease (ADPKD)
- Adrenal hyperplasia, congenital, 150*t*, 261–262, 262*f*
- heterozygote advantage in, 88*t*
  - prenatal testing, 314–315
  - screening test for, 148*t*
  - treatment for, 205*t*
- Adrenoleukodystrophy, X-linked, 268–269
- Adult polycystic kidney disease
- tissue transplantation for, 206
  - treatment for, 205*t*
- Adverse events, 203–204
- AER. *see* Apical ectodermal ridge (AER)
- Afrikaners, recessive disorders that are common in, 87, 87*t*
- Agammaglobulinemia, Bruton-type, 172
- Age of onset, delayed, 96–97
- Albinism, 1–2, 4, 87, 87*t*
- ocular, X-linked, 123
  - oculocutaneous, 257*f*–258*f*, 258
  - tyrosinase-negative, 258
  - tyrosinase-positive, 258
- Alcohol
- neurodevelopmental defects, 226
  - teratogenic effects of, 225*t*, 226, 226*f*
- Alkaptonuria, 257*f*, 258
- Alleles, 2
- epialleles, 122
  - ‘fixed’, 85
  - frequencies in population, 83–88, 83*f*
  - multiple, 75
  - possible genotypes, phenotypes, and gametes formed from, 75, 75*t*
- Allelic association, 91
- Allelomorphs, 2. *see also* Alleles
- Alpha-1 antitrypsin deficiency (AATD), 288
- Alport syndrome (AS), 144*t*, 298
- ALS. *see* Amyotrophic lateral sclerosis (ALS)
- Alstrom syndrome, 117*t*
- Alternative polyadenylation, 17
- Alternative splicing, of genes, 17
- Alu repeats, 13
- Alveolar rhabdomyosarcoma, 119*t*
- Alzheimer disease, 142–143
- biochemical studies for, 142
  - in Down syndrome, 237
  - epidemiology of, 142
  - family studies for, 142
  - single-gene disorders, 142
  - susceptibility genes for, 142–143
  - twin studies for, 142
- American College of Genetics and Genomics, 327
- regarding secondary (incidental) findings, 328*b*
- American College of Medical Genetics, 321
- American Society of Human Genetics, 321
- Amino acid metabolism, disorders of, 255–260
- Amish, recessive disorders that are common in, 87, 87*t*
- Amniocentesis, 303*t*, 304–306
- diagram of, 304*f*
- Amniotic bands, disruptions due to, 217, 217*f*
- Amorph, 20
- Amplification-refractory mutation system (ARMS) PCR, 55–56, 56*f*
- Amsterdam criteria, revised, for Lynch syndrome, 197
- Amyloid  $\beta$  A4 precursor protein (APP) gene, 142
- Amyotrophic lateral sclerosis (ALS), 278
- diagnostic criteria for, 278*b*
- Anaphase, 29, 30*f*
- Anaphase I, 31*f*, 32
- Anaphase II, 31*f*
- Anaphase lag, 34–35
- Anderson disease (GSD IV), 261
- Anencephaly, 307, 307*f*
- Aneuploidy, 33
- origin of, 34*t*
- Angelman syndrome (AS), 78–79, 79*f*, 122, 244
- genomic imprinting in, 77–78
  - molecular organization of, 78*f*
  - uniparental disomy in, 77
- Angioneurotic edema, treatment for, 205*t*
- Anhidrotic ectodermal dysplasia, 144*t*
- Animal models
- cancer studies, 179
  - of gene therapy, 207–208
  - mouse models for genetic disease, 7–8
  - position-independent identification of human disease genes with, 42–43
  - transgenic, 44
- Aniridia, 109, 112*f*, 220*t*
- Ankylosing spondylitis
- heritability estimates of, 132*t*
  - HLA and, 170*t*
- Antenatal screening. *see* Prenatal testing
- Antibodies
- class switching of, 168–169, 168*f*
  - molecule structure, 167, 167*f*
  - monoclonal, 168
- Antibody allotypes, 167
- Antibody diversity
- DNA studies of, 168
  - generation of, 168
- Antibody engineering, 169
- Antibody gene rearrangement, 168, 168*f*
- Anticipation, 75–76, 76*f*
- Anticodon, 16
- Antiepileptic drugs, 227
- Antigen-binding fragment, 167
- Antisense oligonucleotides, 210
- $\alpha_1$ -Antitrypsin deficiency
- neonatal screening for, 150
  - treatment for, 205*t*
- Antp* gene, 107
- Apert syndrome, 113–114, 113*t*, 114*f*, 220*t*
- Apical ectodermal ridge (AER), 118
- Apolipoprotein E (APOE) gene, 142–143
- Apolipoproteins, 140
- Apoptosis, 22, 104, 181–182, 185
- Arber, Werner, 7*t*
- ARID1B gene, 233–234
- Aristotle, 1
- ARPKD. *see* Autosomal recessive polycystic kidney disease (ARPKD)
- Array CGH, 24*t*, 54, 55*f*
- Arrhythmias, inherited, 289–290, 290*t*



- Arrhythmogenic right ventricular cardiomyopathy (ARVC), 291
- Artemis gene, 173
- Arthritis, rheumatoid, HLA and, 170*t*
- Artificial selection, 92
- against autosomal dominant disorders, 92
  - against autosomal recessive disorders, 92–93
  - against X-linked recessive disorders, 93
- AS. *see* Angelman syndrome (AS)
- ASD. *see* Autistic spectrum disorder (ASD)
- 'Ash leaf' patches, 281*f*
- Ashkenazi Jews, recessive disorders that are common in, 87*t*
- Aspartylglycosaminuria, 87*t*
- Asplenia/polyasplenia, 112–113
- Assisted conception, 313–314
- law and, 314
  - licenses for, 314*b*
- Assisted reproductive technologies, 313–314
- Associated immunodeficiency, 173–174
- Association, 132
- studies, 134–137, 135*f*
- Association of British Insurers, 328
- 'Concordat and Moratorium on Genetics and Insurance' and, 328, 328*b*
- Assortative mating, 84
- Assortment, independent, law of, 3
- Asthma, multifactorial inheritance and, 130
- Ataluren, 206
- Ataxia
- cerebellar, inheritance pattern of, 318*t*
  - Friedreich ataxia (*FXN1*), 19*t*
  - hereditary, 274–275
  - spinocerebellar, 19, 19*t*
- Ataxia telangiectasia, 173–174, 250–251, 251*f*
- ATXN10* gene, 19
- Auriculo-condylar syndrome, 117*t*
- Autism, genome-wide association study of, 135–136, 136*f*
- Autistic spectrum disorder (ASD), 229–230
- diagnostic criteria for, 229–230, 229*b*
  - epidemiology of, 230*b*
- Autoimmune diseases, 170–171
- Autoimmune polyendocrinopathy syndrome type I, 172
- Autoimmune regulator gene, 172
- Autonomy, 323*b*, 324
- Autosomal dominant disorders
- artificial selection against, 92
  - with delayed age of onset, 96–97, 96*f*
  - with reduced penetrance, 95–96, 95*f*
- Autosomal dominant inheritance, 66–70, 68*f*, 74
- features that support, 75*b*
  - genetic risks in, 66, 68*f*
  - risk calculation with, 95–97
  - segregation analysis of, 88
- Autosomal dominant polycystic kidney disease (ADPKD), 296, 297*f*
- Autosomal dominant traits, 66–68
- Autosomal inheritance, 66
- Autosomal recessive disorder, frequency in children of incestuous relationships, 321*t*
- Autosomal recessive disorders
- artificial selection against, 92–93
  - biochemical abnormalities in carriers, 145
  - carrier testing for, 144–145
  - clinical examination of, 146
  - common in certain groups, 87, 87*t*
  - population carrier screening for, 151–152, 151*t*
  - presymptomatic diagnosis of, 145–147
  - specialist investigation for, 146, 146*f*
- Autosomal recessive inheritance, 70–71, 70*f*, 74
- features that support, 75*b*
  - genetic risks in, 70, 70*f*
  - risk calculation with, 97–98, 97*f*
  - segregation analysis of, 88–89, 89*t*
- Autosomal recessive polycystic kidney disease (ARPKD), 297
- Autozygosity, 91
- Autozygosity mapping, 43, 91, 92*f*
- Axial skeleton, 105–107
- Azoospermia, 240
- B**
- Back mutations, 17
- Baltimore, David, 7*t*
- Banana sign, ultrasonographic image, 307, 307*f*
- Bardet-Biedl syndrome, 75, 117*t*
- Barr body, 30, 122
- Barth syndrome, 260
- Basal cell carcinoma, 119*t*
- nevroid, 182, 191*t*, 196*t*
- Base excision repair, 22, 22*t*
- Bateson, William, 4
- Bayes' theorem, 94–95, 95*f*, 99–100
- Bayesian calculations, 95, 95*t*–96*t*, 99*t*–100*t*
- Bayesian tables, 97–98, 97*t*
- B blood group, 85, 85*f*
- Beal syndrome, 293
- Beauchamp, Tom, 323–324
- Beauchamp and Childress framework of ethical principles, 324
- Becker muscular dystrophy, 281–284, 282*f*–283*f*
- neonatal screening for, 144*t*
- Beckwith-Wiedemann syndrome (BWS), 79–80, 80*f*, 122
- genomic imprinting in, 77–78
  - molecular organization of, 80*f*
  - uniparental disomy in, 77
- Behavioral phenotypes, 250
- Beighton score, for joint hypermobility, 295*t*
- Benacerraf, Baruj, 7*t*
- Bence Jones protein, 168
- Benevolence, 323*b*
- Bethesda guidelines, revised, for colorectal cancer, 197
- Bilaminar disc, 102
- Biochemical abnormalities, in carriers, 145
- Biochemical genetics, 4
- Biochemical studies, 142
- Bioinformatics, 46–47
- Biosynthetic products, 206–207, 206*t*
- Biotinidase deficiency, 150*t*
- Birth defects
- asymmetrical, 228, 228*f*
  - classification of, 216–219
  - definition of, 216–219
  - symmetrical, 228*f*
- Birt-Hogg-Dubé syndrome, 191*t*, 196*t*
- Bishop, Michael, 7*t*
- Bivalent, 32
- Bladder carcinoma, chromosomal location of, 183*t*
- Blastocyst, 103
- Blighted ovum, 215
- Blobel, Günter, 7*t*
- Blood chimeras, 40
- Blood disorders, monogenic, 298–301
- Blood groups, 174–175
- ABO, 174–175, 174*t*
  - B, 85, 85*f*
  - Rhesus, 175
- Bloom syndrome, 251
- BMPRIA*, 192
- Bone marrow, gene therapy and, 208
- Bone-marrow transplantation, 210
- Bone morphogenetic proteins, 104
- BOR syndrome. *see* Branchio-oto-renal (BOR) syndrome
- Boveri, Theodour, 3
- Bowel, increased echogenicity of, 312, 312*f*
- Brachmann-de Lange syndrome, 230
- Brachydactyly, 220*t*
- Brachyury* gene, 110–112
- BRAF* gene, 221*t*
- Branched-chain amino acid metabolism, disorders of, 260
- Branchio-oculo-facial syndrome, 116*f*, 117*t*
- Branchio-oto-renal (BOR) syndrome, 117*t*
- BRCA1* gene, 193
- genotype-phenotype correlation, 21
  - mutation of, Manchester Scoring System for, 195*t*
  - patents, 329
- BRCA2* gene, 193
- mutation of, Manchester Scoring System for, 195*t*
  - patents, 329
- Breakpoint cluster, 180
- Breast cancer, 192–193
- chromosomal location of, 183*t*
  - family and twin studies in, 178
  - lifetime risk of, 194*t*
  - oncogene amplification in, 180
  - screening for, 196*t*, 197
  - treatment for, 198*t*
  - tumor suppressor mutations in, 187*t*
- Breast-ovarian cancer, tumor suppressor mutations in, 187*t*
- Brenner, Sydney, 7*t*
- Brown, Michael, 7*t*
- Brugada syndrome, 289–290
- Bruton-type agammaglobulinemia, 172
- Burkitt lymphoma, 180
- BWS. *see* Beckwith-Wiedemann syndrome (BWS)
- C**
- c.1521\_1523delCTT, 287
- CA repeats, 52

- Café-au-lait (CAL) spots, 279, 279f  
 CAL spots. *see* Café-au-lait (CAL) spots  
 Campomelic dysplasia, 109–110, 112f  
 Cancer. *see also specific cancers*  
   developmental genes and, 119–121  
   disease associations, 178  
   DNA methylation and, 185, 186f  
   drugs effective for, 204, 204t  
   environmental factors in, 177–179  
   epidemiology of, 177–178  
   epigenetics and, 185–186  
   family studies in, 178  
   genes that can cause, 119t  
   genetic architecture of, 178f  
   genetics, 177–198, 199b  
   telomere length and, 185–186, 186f  
   twin studies in, 178  
   viral factors in, 179, 179t  
 Cancer-predisposing syndromes, inherited, 193–194  
 Candidate genes, 42, 44  
   confirmatory testing for, 44  
   positional, 42–43  
 Capecchi, Mario, 7t  
 Carbohydrate metabolism, disorders of, 260–261  
 Carcinogenesis, multistage process of, 187–188, 187t  
 Cardiac malformations, 223b  
 Cardio-facio-cutaneous syndrome, 221, 223f  
 Cardiomyopathies, inherited, 290–291  
 Carlsson, Arvid, 7t  
 Carrier frequencies, 86, 86t  
 Carrier risk  
   Bayesian tables for, 97–98, 97t  
   for extended family, 97, 97f  
   modifying, by mutation analysis, 97–98  
 Carriers  
   biochemical abnormalities in, 145  
   clinical manifestations in, 144–145  
 Carrier testing  
   for autosomal recessive and X-linked disorder, 144–145  
   ethical considerations in, 147  
   incorporating results from, 98–99, 99t  
   population carrier screening, 151t  
   for X-linked immunodeficiencies, 174, 174f  
 Cartilage-hair hypoplasia, 87t  
 Cascade screening, 152, 288  
 Case-control study, 134–135  
 Cataracts, 220t  
   congenital, inheritance pattern of, 318t  
 Catecholaminergic polymorphic ventricular tachycardia (CPVT), 290  
 Causal heterogeneity, 100–101, 101t  
 CCA. *see* Congenital contractural arachnodactyly (CCA)  
 CDKN1C genes, 79  
 Celiac disease, HLA and, 170t  
 Cell, 9, 9f  
 Cell cycle, 30, 30f  
 Cell-cycle factors, apoptosis and, 181–182  
 Cell division, 24–40  
 Cell-free fetal DNA (cffDNA), 314–315, 315f  
 Cell-mediated immunity, 164  
 Cell-mediated innate immunity, 164–165  
   disorders of, 171–172  
 Cell-mediated specific acquired immunity, 169–171, 169f  
   disorders of, 173  
 Cellular biology, 9  
 Cellular oncogenes, 179  
 Centimorgans (cMs), 90  
 Central nervous system  
   gene therapy and, 208  
   malformations, 223b  
 Centric fusion, 36  
 Centrioles, 29  
 Centromeres, 24  
 Centromeric probes, 27  
 Cerebellar ataxia, inheritance pattern of, 318t  
 Cerebral gigantism, 221  
 CF. *see* Cystic fibrosis (CF)  
 cffDNA. *see* Cell-free fetal DNA (cffDNA)  
 CGD. *see* Chronic granulomatous disease (CGD)  
 CGH. *see* Comparative genomic hybridization (CGH)  
 Chain termination, 157  
   mutations, 160  
 Charcot-Marie-Tooth (CMT) disease, 66–68, 275–277  
   different forms of, 276f  
   inheritance pattern of, 317–318  
   X-linked, 73  
 CHARGE syndrome, 230, 231f  
 Chemical mutagens, 21–22  
 Chemicals, as teratogens, 225–226  
 Chiasmata, 3, 32  
 Childhood  
   acquired diseases, that show multifactorial inheritance, 130  
   genetic disease in, 6  
   mortality due to congenital abnormalities, 216  
   predictive testing in, 326  
 Childress, James, 323–324  
 Chimerism, 40  
   blood chimeras, 40  
   definition of, 40  
   dispermic chimeras, 40  
 Chloroquine, teratogenic effects of, 225t  
 CHM gene, 209  
 Choice, informed, 324  
 Chondrodysplasia punctata, rhizomelic, 269  
 Chorionic villus sampling, 306  
   transvaginal technique of, 306f  
 Choroid plexus cysts, bilateral, 312, 312f  
 Choroidemia, gene therapy for, 209  
 Christmas disease, 300. *see also* Hemophilia B  
 Chromatids, 24  
 Chromatin, 25  
 Chromatin fibers, 11  
 Chromosomal translocation breakpoints, oncogenes at, 179–180  
 Chromosome 11, 12, 12f  
 Chromosome 15q deletions, and microdeletions, 250, 251f  
 Chromosome 16, 12, 12f  
 Chromosome abnormalities, 4–5, 28–29, 44  
   ambiguous result, 311  
   family history of, 310  
   incidence of, 236–239, 236t–237t, 237f  
   malformations due to, 220  
   numerical, 33–35  
   prenatal ultrasonographic findings, 310t  
   previous child with, 310  
   structural, 35–40  
   types of, 33b  
   unexpected result, 311–312  
 Chromosome analysis, 26–27  
 Chromosome banding, 26–27  
 Chromosome breakage syndromes, 193–194, 250–253  
   malignancy and, 254  
   sister chromatid exchange and, 253  
 Chromosome deletion syndromes, 243–245  
 Chromosome disorders, 236–254, 254b  
   behavioral phenotypes and, 250  
 Chromosome nomenclature, 28–29, 29f  
 Chromosome painting, 28, 28f, 38f  
 Chromosome-specific unique-sequence probes, 27–28, 28f  
 Chromosomes, 3, 3f, 9, 24–40, 41b  
   acrocentric, 25, 25f  
   as basis of inheritance, 3, 3f  
   classification of, 25  
   diploid complement of, 25  
   double-minute, 180  
   G (Giemsa) banding, 24t, 26–27, 27f–28f  
   haploid complement of, 25  
   human, 24–26  
   isochromosomes, 39–40  
   maternal, 35  
   metacentric, 25, 25f  
   morphology of, 24–25, 25f  
   nomenclature, 28–29  
   number of, 3  
   paternal, 35  
   preparation, 24t, 26, 26f  
   pseudoautosomal region, 31  
   ring chromosomes, 39–40, 40f  
   sex chromosomes, 25–26, 26f  
   solenoid model of, 11, 11f  
   structure, 10–11  
   submetacentric, 25, 25f  
   term, 24  
   whole-chromosome paint probes, 28  
 Chronic granulomatous disease (CGD), 172  
 Chronic myeloid leukemia, 180, 180f  
 Cilia, in developmental abnormalities, 115, 118f  
 Ciliopathies, 115, 117t  
 Circulating tumor DNA (ctDNA), 188–189  
 Cleft lip/palate, 134f  
   familial risk of, 134  
   multifactorial inheritance and, 130  
 Cleidocranial dysplasia, 228, 228f  
 Clinical ethics. *see also* Ethical issues  
   Jonsen framework for, 324, 324b  
 Cloning  
   ethical dilemmas and, 330  
   functional, 42  
   positional, 42–44  
 Club foot, 217, 217f  
 cMs. *see* Centimorgans (cMs)

- CMT disease. *see* Charcot-Marie-Tooth (CMT) disease
- CNBP gene, 19
- Co-dominance, 69
- Codons  
stop or termination, 16  
triplet, 16
- Coffin-Siris syndrome-*ARID1B*, 232–234, 234f
- Colony-stimulating factor receptor (*CSF3R*) gene, 172
- Color blindness, 4
- Colorectal cancer (CRC)  
development of, 186–188, 187f  
hereditary non-polyposis, 190–191  
lifetime risk of, 194t  
screening for, 196t, 197
- Colorectal carcinoma, chromosomal location of, 183t
- Common acquired diseases, multifactorial inheritance and, 130
- Common variable immunodeficiency (CVID), 173
- Communication, 319
- Community genetics, 144
- Comparative genomic hybridization (CGH), 5  
array, 24t, 54, 55f  
microarray, 5, 62, 64f, 245–250  
for dosage analysis, 62  
indications for, 253–254, 253b
- Comparative genomics, 46
- Complement system, 165–166  
activation of, 165, 165f  
classic pathway of, 166–167  
disorders of, 171  
effector roles of, 165–166, 166f  
nomenclature for, 165–166
- Complete hydatidiform mole, 121
- Complex traits, 75
- Compound heterozygotes, 71
- C-onc*, *v-onc* and, relationship between, 179
- Concordant, 131
- ‘Concordat and Moratorium on Genetics and Insurance’, 328, 328b
- Confidentiality, 325, 327
- Confined placental mosaicism (CPM), 311
- Congenital, term, 5
- Congenital abnormalities, 215–235, 235b  
causes of, 220t  
and childhood mortality, 216  
counseling for, 229  
definition of, 216  
due to single-gene defects, 220–222, 220t  
family history of, 310–311  
genetic heterogeneity of, 222–225  
incidence of, 215–216  
major, 215, 216t  
minor, 215, 216b  
multifactorial inheritance of, 222, 223b  
multiple, 218–219  
association, 219  
sequence, 218, 219f  
syndrome, 218–219, 219f  
and perinatal mortality, 215  
single, 216–218  
structural, 216b, 216t, 310–311
- Congenital adrenal hyperplasia, 150t, 261–262, 262f  
heterozygote advantage in, 88t  
prenatal testing, 314–315  
screening test for, 148t  
treatment for, 205t
- Congenital cataract, inheritance pattern of, 318t
- Congenital chloride diarrhea, 87t
- Congenital contractural arachnodactyly (CCA), 293
- Congenital dislocation of the hip, multifactorial inheritance and, 130
- Congenital erythropoietic porphyria, 266
- Congenital heart defects, multifactorial inheritance and, 130
- Congenital hypothyroidism, 150t  
neonatal screening for, 150–151  
treatment for, 205t
- Congenital malformations, 5  
frequency in children of incestuous relationships, 321t  
that show multifactorial inheritance, 130b
- Congenital nephrotic syndrome, 87t
- Congenital neutropenia, sporadic, 172
- Connective tissue disorders, monogenic, 291–295
- Connexin* 32 gene, 276–277
- Consanguineous marriage, 320, 320t
- Consanguinity, 70, 84, 320, 320f
- Conservative substitutions, 20
- Constant (C) regions, 168
- Consultand, dummy, 96
- Consultant, definition of, 317
- Contig analysis, 44
- Contiguous gene syndromes, 44, 244–245
- Copper metabolism, disorders of, 266–267
- Coproporphyrin, hereditary, 266
- Copy number changes, detecting, 61t
- Cordocentesis, 306
- Cori disease (GSD III), 261
- Cornelia de Lange syndrome (CdLS), 230, 231f
- Coronary artery disease, 140–141  
family studies of, 140  
premature, 140t  
single-gene disorders of lipid metabolism leading to, 140  
susceptibility genes, 140–141  
twin studies of, 140
- Correlation, 133
- Costello syndrome, 221, 223f
- Coumarin metabolism, by CYP2C9, 202
- Coumel’s ventricular tachycardia, 290
- Counseling  
for congenital abnormalities and dysmorphic syndromes, 229  
for familial cancer, 193–198, 193b, 194f  
genetic, 66, 229, 317–323  
person-centered approach in, 319  
psychodynamic approach in, 319  
scenario-based decision counseling and, 319
- Cowden disease, 182, 191t, 192, 192f  
screening for, 196t
- CPM. *see* Confined placental mosaicism (CPM)
- CPVT. *see* Catecholaminergic polymorphic ventricular tachycardia (CPVT)
- Craniosynostosis syndromes, 69, 113–114, 117t
- CRC. *see* Colorectal cancer (CRC)
- Creatine kinase (CK) levels, 145f
- CREBBP* gene, 107
- ‘Cretinism’, 150–151
- Cri-du-chat syndrome, 243, 244f
- Crick, Francis, 3–4, 6, 7t, 9–10
- CRISPR/Cas9 technology, 44, 45f, 210
- Crohn disease, 139–140
- Crossing over, 30–31
- Crouzon syndrome, 113–114, 113t
- Cryptic splice sites, 20
- ctDNA. *see* Circulating tumor DNA (ctDNA)
- Culture artifact, 311
- Culture failure, 311
- CVID. *see* Common variable immunodeficiency (CVID)
- Cyclic neutropenia, 172
- Cyclopia, 107
- CYP2C9 gene, coumarin metabolism by, 202
- CYP2D6 gene, debrisoquine metabolism by, 202
- CYP21 gene, 170–171
- Cystic fibrosis (CF), 150t, 286–288  
clinical features of, 286  
drug treatment of, 206  
genetics of, 286–288  
genotype-phenotype relationship, 287  
heterozygote advantage in, 88, 88t  
linkage analysis of, 43  
lung transplantation for, 206  
neonatal screening for, 151  
pancreatic insufficiency (PI) form, 287  
pancreatic sufficient (PS) form, 287  
population carrier screening for, 151–152  
population screening for, 97, 329–330  
treatment for, 205t
- Cystic fibrosis transmembrane conductance regulator (*CFTR*) gene, 286–287, 287f  
cloning of, 206  
confirmatory testing for, 44  
mutation nomenclature, 18t  
mutations in, 287  
amplification-refractory mutation system (ARMS)-PCR for, 56f
- Cystinuria, 4  
treatment for, 205t
- Cytogenetics, 5, 24  
development of methodologies, 24t  
molecular, 27–28
- Cytokine, 105
- Cytomegalovirus, 227, 227t
- Cytoplasm, 9
- Cytoplasmic or mitochondrial inheritance, 80
- Cytotoxic T cells, 169
- D**
- Dalton, John, 4
- Daltonism, 4
- Danazol, 171
- DAPC. *see* Dystrophin-associated protein complex (DAPC)
- Darlington, Cyril, 3
- Darwin, Charles, 5
- Databases, DNA, 328–329
- Dausset, Jean, 7t

- de Maupertuis, Pierre, 1–2, 4
- Deafness. *see* Hearing loss
- Debrisoquine metabolism, by CYP2D6, 202
- Decay, nonsense-mediated, 20
- DeCODE, 329
- Deformation, 217, 217*f*. *see also* Malformations
- Degenerate code, 16
- Delayed age of onset, 96–97
- Deleted in colorectal cancer (*DCC*) gene, 187
- Deletion 1p36 syndrome, 247–248, 248*f*
- Deletion 1q21.1 syndrome, 248–249, 249*f*
- Deletion 4p syndromes, 243
- Deletion 5p syndromes, 243
- Deletion 9q34 syndrome, 248, 248*f*
- Deletion 11p13, 243–244, 245*f*
- Deletion 16p11.2 syndrome, 249, 250*f*
- Deletion 17q21.31 syndrome, 248, 249*f*
- Deletion 22q11 syndrome, 245, 246*f*
- Deletion 22q11.2 syndrome, 173
- Deletion Xp22.3, 245
- Deletions, 18, 37
- in *dystrophin* gene, 283
  - frequency, 18*t*
  - microdeletion, 27–28
  - partial gene, 18*t*
  - whole gene, 18*t*
- Delta-like-1* gene, 106–107
- Delta-like-3* gene, 106–107, 107*f*
- Dementia, 142, 142*t*
- Dentatorubral-pallidolusian atrophy (*ATN1*), 19*t*
- Denys-Drash syndrome, 112, 112*t*, 119*t*
- Deoxyribonucleic acid. *see* DNA (deoxyribonucleic acid)
- Development
- epigenetics and, 121–123
  - X-chromosome inactivation during, 122–123, 122*f*
- Developmental anomalies, 119*t*
- Developmental gene families, 103–114
- Developmental genes
- and cancer, 119–121
  - and positional effects, 121, 121*t*
- Developmental genetics, 102–129, 129*b*
- DHODH* gene, 47
- Diabetes mellitus, 138–139
- maternal, 227
  - maturity-onset diabetes of the young, 202–203, 203*f*
  - neonatal, 203
  - type 1, 170*t*
    - heritability of, 132*t*, 138
    - islet transplantation for, 206
  - type 2
    - heritability of, 132*t*, 138–139, 139*f*
    - heterozygote advantage in, 88*t*
- Diagnosis, establishing, 317–318
- Diakinesis, 31*f*, 32
- Diastrophic dysplasia, 87*t*
- Dictyotene, 32
- Dideoxy sequencing, 57, 59*f*
- Diethylstilbestrol, teratogenic effects of, 225*t*
- Differentially methylated regions (DMRs), 77
- Differentiation, 104
- Digenic inheritance, 75
- DiGeorge/Sedláčková syndrome, 114–115, 173, 222–223, 245, 246*f*
- Dihydropyrimidine dehydrogenase, 202
- Dilated cardiomyopathy, 290–291
- Diplotene, 31*f*, 32
- Direct method, of mutation rates
- estimation, 86
- Direct mutation testing, 147
- Disclosure, 327*b*
- Disease, 148. *see also specific diseases*
- Disomy, 33–34, 34*f*
- uniparental, 77, 77*f*
- Disorders of sex development (DSDs), 123–127, 125*f*
- classification of, 125–127
  - diagnostic tree of, 127*f*
  - nomenclature relating to, 125*t*
- Dispermic chimeras, 40
- Dispermy, 35, 121
- Disruption, 217, 217*f*
- Diversity (D) regions, 168
- Dizygotic twins, 128*t*, 129
- DMD. *see* Duchenne muscular dystrophy (DMD)
- DMRs. *see* Differentially methylated regions (DMRs)
- DMRT1* gene, 124–125
- DNA (deoxyribonucleic acid), 9–10
- antiparallel, 9–10
  - antisense strand, 14
  - as the basis of inheritance, 3–4
  - boundary elements, 16
  - double helix, 10*f*
  - extragenic, 12–13
  - hypervariable minisatellite DNA, 13
  - junk, 12
  - lagging strand, 10
  - leading strand, 10
  - microsatellite, 13
  - minisatellite, 13
  - mitochondrial, 13–14
  - noncoding, 20
  - promoter region, 16
  - satellite, 13
  - segments coding of, for  $\kappa$ ,  $\lambda$ , and various heavy chains, 168, 168*f*
  - sense strand, 14
  - sequencing, 5–6
  - structure of, 9–10, 10*f*
  - telomeric, 13
  - 3' end, 9–10
- DNA-binding domain, 17
- DNA-binding nuclear proteins, 181
- DNA 'chips.' *see* DNA microarrays
- DNA cross-link repair protein 1c (*DCLRE1C*), 173
- DNA databases, 328–329
- DNA fingerprinting, 321
- DNA markers, linked, 145
- DNA methylation, 79, 79*f*, 122
- cancer and, 185, 186*f*
  - gain of, 79–80
  - loss of, 79–80
- DNA microarrays, 54
- DNA mismatch repair genes, 177, 190–191
- DNA repair, 22, 22*t*
- DNA replication, 10, 11*f*
- origins of, 10
  - semiconservative, 10
  - slipped strand mispairing, 13
- DNA sequences
- exon splicing enhancer sequences, 20
  - highly repeated interspersed repetitive, 13
  - tandemly repeated, 13
  - types of, 11–14, 12*b*
- DNA synthesis
- RNA-directed, 17
  - translesion, 22
- DNA technologies, development of, 45–46, 50*t*
- DNA transfection, 180–181
- DNA transfection studies, 180–181
- DNA tumor profiling, 188–193, 188*f*
- DNA viruses, in carcinogenesis, 179, 179*t*
- DOCK8*, 173
- Dolly, 330
- Dominant characteristics, 2
- Dominant-negative mutations, 20–21
- Donor insemination, 314
- Dosage analysis, 60–62
- microarray comparative genomic hybridization for, 62
  - multiplex ligation-dependent probe amplification for, 62, 62*f*–63*f*
  - quantitative fluorescent PCR for, 62, 63*f*
- Dosage compensation, 122–123
- Dosimetry, 21
- Double bubble sign, ultrasonographic image, 309*f*
- Double heterozygotes, 70–71, 75
- Double-minute chromosomes, 180
- Down, Langdon, 236
- Down syndrome (trisomy 21), 4–5, 33, 218, 236–238
- chromosome findings in, 237–238, 238*t*
  - chromosome painting of, 38*f*
  - clinical features of, 236, 237*b*, 238*f*
  - dementia in, 142
  - detection rates, 308*t*
  - incidence of, 236
  - maternal age and, 237*t*
  - maternal risk for, 308*t*, 309*f*
  - natural history of, 237
  - prenatal screening, 308–309
  - QF-PCR result on a fetus, 305*f*
  - recurrence risk of, 238
  - spontaneous pregnancy loss in, 237*t*
  - translocation in, 37
  - triple test, 308
  - ultrasonography, 308–309, 309*f*
- DPYD* gene, 202
- Droplet digital PCR, 56
- for dosage analysis, 62
- Drosophila melanogaster*, 4
- advantages for the study of genetics, 4
  - genome, 4
  - Hox* genes in, 108, 111*f*
- Drug metabolism, 200–201, 205*t*
- biochemical modification of, 200, 201*f*
  - kinetics of, 200–201, 201*f*
  - stages of, 200, 200*f*

- Drugs  
 adverse events to, 203–204  
 for cancer, 204, 204t  
 efficacy of, 204, 204f  
 genetic variations revealed by, 201–202  
 as teratogens, 225–226, 225t
- Drug treatment, 205–206
- DSDs. *see* Disorders of sex development (DSDs)
- Duchenne muscular dystrophy (DMD), 71, 72f, 150t, 281–284, 282f  
 chromosome abnormalities of, 44  
 drug therapy for, 206  
 gene tracking in, 53f  
 isolated case of, 98, 99f  
 linked polymorphic markers in, 145  
 neonatal screening for, 144t, 150  
 X-autosome translocations in, 73, 73f
- Dulbecco, Renato, 7t
- Dummy consultant, 96
- Dunnigan-type familial partial lipodystrophy, 66–68, 69f
- Duplication 16p11.2, 249–250, 250f
- Duplication 22q11.2, 245–246, 246f
- Dynamic mutations, 18–19, 18t
- DYNC111* gene, 103
- DYNC2H1* gene, 115
- Dysautonomia, 87t
- Dysmorphic syndromes, 215–235, 235b  
 genetic counseling for, 229  
 incidence of, 215–216  
 renal involvement and, 296
- Dysmorphology, 218–219
- Dysplasia, 217–218  
 diastrophic, 87t  
 ectodermal, 217–218, 218f  
 thanatophoric, 217–218, 218f
- Dysplastic nevus syndrome, 191t
- Dystrophia myotonica protein kinase (*DMPK*) gene, 286
- Dystrophin-associated protein complex (DAPC), 283f  
*dystrophin* gene, 283  
*dystrophin* protein, 283
- E**
- EA. *see* Episodic ataxia (EA)
- Early infantile epileptic encephalopathy  
 KCNQ2-associated, 234, 235f  
 SMC1A-associated, 235
- Early patterning, 104–105
- Ectoderm, 114–115
- Ectodermal dysplasia, 217–218, 218f
- Ectodermal structures, 103
- Ectrodactyly, 220, 220f, 220t
- Edema, angioneurotic, treatment for, 205t
- 'Edmonton' protocol, 206
- EDS. *see* Ehlers-Danlos syndrome (EDS)
- Edwards syndrome (trisomy 18), 33, 238, 239f
- EEC syndrome, 220, 220t
- EGFR* mutation, 204, 204f
- Ehlers-Danlos syndrome (EDS), 294–295, 295f, 317–318, 318f, 318t  
 Villefranche classification of, 294t
- ELA2*, 172
- Ellis-van Creveld syndrome, 87t, 117t
- Embryoblast, 121
- Embryonic stage, 102, 102t
- Embryonic stem cell therapy, 212
- Emery-Dreifuss muscular dystrophy, 66–68
- Empiric risks, 100–101
- EMSY* gene, 192
- Encephalopathy, early infantile epileptic  
 KCNQ2-associated, 234, 235f  
 SMC1A-associated, 235
- ENCODE (Encyclopedia of DNA Elements) project, 46–47
- Endoderm, 114–115
- Endodermal structures, 103
- Endometrial cancer, 196t
- Endoplasmic reticulum, 9
- Endoreduplication, 121
- Energy metabolism, disorders of, 269–271
- Environmental agents, 225–228
- Environmental factors, in cancer, 177–179
- Enzyme replacement, for treatment of  
 genetic disease, 205, 205t
- Epialleles, 122
- Epigenetics  
 cancer and, 185–186  
 concept of, 121–122
- Epilepsy, maternal, 227–228
- Episodic ataxia (EA), 275
- Epithelial ovarian cancer, 193
- Epstein-Barr virus, 179t
- Erlotinib (Tarceva), 204, 204t
- Erythroblastosis fetalis, 175
- Erythropoietic porphyria, congenital, 266
- Erythropoietic protoporphyria, 266
- Erythropoietin, biosynthetic, 206t
- Ethical issues  
 in carrier detection and predictive testing, 147  
 dilemmas in genetics clinic, 325–327  
 Ethox Centre clinical ethics framework and, 324, 324b  
 of Human Genome Project, 46  
 Jonson framework and, 324, 324b  
 in medical genetics, 323–331, 331b  
 public interest and, 327–330
- Ethics, definition of, 323
- Ethox Centre Clinical Ethics Framework, 324, 324b
- Etiological heterogeneity, 317
- Euchromatin, 25
- Euchromatin histone methyl transferase 1 (*EHMT1*) gene, 248
- European Court of Human Rights, 328–329
- Evans, Martin, 7t
- Exome chips, 137
- Exome sequencing, 42, 47–48, 47f–48f, 48t, 64t
- Exomphalos, 309, 309f
- Exon splicing enhancer sequences, 20
- Extended family, implications for, 327
- Extracellular killing, 165
- Eye, gene therapy and, 208–209
- F**
- Fabry disease, 265  
 neonatal screening for, 144t  
 treatment for, 205t
- Facial angiofibromas, 281f
- Facioscapulohumeral muscular dystrophy (FSHD), 282f, 284–285, 284f–285f
- Factor V Leiden, real-time PCR, 58f
- Factor VIII, biosynthetic, 206t
- Factor IX, biosynthetic, 206t
- Familial adenomatous polyposis (FAP), 182, 189–190, 190f, 192–193  
 chromosomal location of, 183t  
 risk for, 147  
 screening for, 196t  
 treatment for, 198t, 205t  
 tumor suppressor mutations in, 187t
- Familial cancer  
 genetic counseling in, 193–198, 193b, 194f  
 screening for, 194–198
- Familial cancer-predisposing syndrome, 193–194  
 prophylactic surgery for, 198t  
 screening for, 196t  
 suggested screening guidelines for, 196t
- Familial hypercholesterolemia, 140, 262–263, 262f–263f  
 treatment for, 205t
- Familial partial lipodystrophy, Dunnigan-type, 66–68, 69f
- Familial retinoblastoma, 191t
- Familial risk, 134
- Familial thoracic aortic aneurysm disease (FТАAD), 293–294
- Family  
 extended, 327  
 immediate, 326–327
- Family balancing, 325–326
- Family history  
 of chromosome abnormality, 310  
 of congenital structural abnormalities, 310–311  
 of single-gene disorder, 310  
 of undiagnosed learning difficulty, 311
- Family screening, 144
- Family studies, 66  
 of Alzheimer disease, 142  
 of cancer, 178  
 of coronary artery disease, 140  
 of schizophrenia, 141  
 terminology for, 66
- Family trees, 66, 67f–68f
- Fanconi anemia, 252, 252f, 252t
- FAP. *see* Familial adenomatous polyposis (FAP)
- Fatty acid metabolism, disorders of, 269
- Fertilization, 102–103
- Fetal alcohol syndrome, 226, 226f
- Fetal anomaly scanning, 309
- Fetal anomaly screening, 149
- Fetal hemoglobin, hereditary persistence of, 161
- Fetal mosaicism, true, 311
- Fetal stage, 102, 102t
- Fetal valproate syndrome (FVS), 227, 228f
- Fetoscopy, 303t, 306
- FGF1* gene, 115–118
- FGF2* gene, 115–118
- FGF4* gene, 115–118
- FGF8* gene, 115–118
- FGFR1* gene, 113f
- FGFR2* gene, 69, 113f
- FGFR3* gene, 113, 113f, 113t, 217–218

- FGFRs. *see* Fibroblast growth factor receptors (FGFRs)
- FGFs. *see* Fibroblast growth factors (FGFs)
- Fibrillin  
type 1, 292  
type 2, 293
- Fibroblast growth factor receptors (FGFRs), 113–114  
developmental disorders caused by mutations in, 113*t*  
structure of, 113*f*
- Fibroblast growth factors (FGFs), 104
- Filamin A (*FLNA*) gene, 66–68
- Fingerprint, DNA, 52
- Fingerprinting, DNA, 321
- Fire, Andrew, 7*t*
- First-degree relatives, 133
- First-trimester pregnancy loss, spontaneous, 215
- FISH. *see* Fluorescent in-situ hybridization (FISH)
- Fisher, Ronald, 132
- 5' cap, 15
- 5' capping, 15
- Fluorescent dideoxy DNA sequencing, 57, 59*f*
- Fluorescent in-situ hybridization (FISH), 5, 24*t*, 27–28  
centromeric probes, 27  
chromosome-specific unique-sequence probes, 27–28  
types of probes, 27–28  
whole-chromosome paint probes, 28
- Forensic science, 328–329  
45, X. *see* Turner syndrome (45, X)  
46, XX DSDs, 126*f*, 127, 128*b*  
46, XY DSDs, 126–127, 127*b*  
46,Xr(X) phenotype, 241  
47, XXY. *see* Klinefelter syndrome (47, XXY)  
47,XXX, 241, 311–312  
47,YYY, 311–312
- Founder case, 91
- Founder effects, 87
- Founder haplotype, 91
- Fragile site, 241
- Fragile X chromosome, 241, 242*f*
- Fragile X site A (*FMR1*), 19*t*
- Fragile X site E (*AFF2*), 19*t*
- Fragile X syndrome, 241–243  
clinical features of, 241, 242*f*  
genetic counseling and, 242–243  
genotype-phenotype correlations of, 243*t*  
molecular defect of, 241–242, 243*f*
- Fragile X tremor/ataxia syndrome (FXTAS), 242
- Frameshift mutations, 18*t*, 20
- Framework regions, 168
- Franklin, Rosalind, 3–4
- Fraternal twins, 129
- FRAXA*, 241–242
- FRAXE*, 242
- Frequency, 5
- Friedreich ataxia, 275  
PCR for, 55*f*  
triplet repeat expansion and, 19*t*
- Frontometaphyseal dysplasia, 66–68
- Fructose intolerance, hereditary, 260
- Fruit fly, 4  
advantages for the study of genetics, 4  
genome, 4
- FSHD. *see* Facioscapulohumeral muscular dystrophy (FSHD)
- FTAAD. *see* Familial thoracic aortic aneurysm disease (FTAAD)
- Functional cloning, 42
- Functional genomics, 46
- Fusion polypeptides, 157
- Fusion protein, 180
- FVS. *see* Fetal valproate syndrome (FVS)
- FXTAS. *see* Fragile X tremor/ataxia syndrome (FXTAS)
- G**
- G<sub>0</sub> phase, 30
- G<sub>1</sub> phase, 30, 30*f*
- G<sub>2</sub> phase, 30, 30*f*
- G6PD. *see* Glucose 6-phosphate dehydrogenase (G6PD)
- Gain-of-function mutations, 20, 119–121
- Galactosemia, 260  
neonatal screening for, 150, 150*t*  
treatment for, 205*t*
- $\alpha$ -Galactosidase A, biosynthetic, 206*t*
- Galton, Francis, 5
- Gametes  
mutations in, 17  
possible genotypes, phenotypes, and gametes formed from alleles at ABO locus, 75, 75*t*
- Gametogenesis, 32–33, 32*t*
- Gap junction protein gene *GJB1*, 276–277
- Garrod, Archibald, 4
- Gastric cancer  
chromosomal location of, 183*t*  
disease associations with, 178  
screening for, 196*t*  
tumor suppressor mutations in, 187*t*
- Gastrulation, 102–103, 103*b*
- Gaucher disease, 87*t*, 265  
protein/enzyme replacement for, 205  
treatment for, 205*t*
- G (Giemsa) banding, 24*t*, 26–27, 28*f*  
G-banded metaphase spread, 28*f*  
normal G-banded male karyotype, 27*f*
- Geftinib (Iressa), 204, 204*t*
- Gene amplification, 180
- Gene correction, targeted, 210
- Gene expression  
cycling, 105–106  
posttranscriptional control of, 17  
regulation of, 16–17, 17*f*  
RNA-mediated control of, 17
- Gene families  
classic, 12  
multigene, 12
- Gene flow (migration), 85
- Gene mapping  
for human disease genes, 42  
of human inherited diseases, 45, 45*f*  
trinucleotide repeat disorders for, 43
- Gene patenting, 329
- Gene shuffling, 32
- Gene size, 87
- Gene structure, 12, 13*f*
- Gene superfamilies, 12
- Gene therapy, 7–8, 207–210  
animal models of, 207–208  
for cystic fibrosis, 288  
definition of, 207  
diseases potentially treated by, 207*t*  
ethical dilemmas in, 329  
ex vivo, 208*f*  
gene transfer in, 208–210  
germline, 207  
non-viral methods of, 209–210  
regulatory requirements of, 207  
somatic cell, 207  
target organs of, 208–209  
technical aspects, 207–208  
using embryonic stem cells, 212–213, 212*f*  
viral agents for, 209  
adeno-associated viruses, 209  
adenoviruses as, 209  
lentiviruses as, 209  
in vivo, 208*f*
- Gene Therapy Advisory Committee (GTAC), 329
- Gene tracking, clinical applications of, 52, 53*f*
- Gene transfer, 208–210
- Genes. *see also specific genes*  
developmental, 103–114, 119–121  
housekeeping, 16  
immunoglobulin superfamily, 169  
nuclear, 12  
polygenes, 132  
pseudogenes, 12  
signal transduction ('signaling'), 113–114  
single-copy, 12  
term, 2  
theory of, 3  
tumor suppressor, 182–185  
zinc finger, 112–113
- Genetic code, 16, 16*t*
- Genetic counseling, 66, 317–323, 322*b*  
for congenital abnormalities and dysmorphic syndromes, 229  
definition of, 317  
directive or non-directive, 319  
discussing options, 319  
in familial cancer, 193–198, 193*b*, 194*f*  
outcomes in, 319–320  
person-centered approach in, 319  
special issues in, 320–321  
steps in, 317*b*
- Genetic diagnosis, preimplantation (PGD), 313, 313*t*
- Genetic disease/disorders  
acquired somatic, 5  
adoption and, 321  
in adult life, 6  
assisted conception and, 313–314  
in childhood, 6  
establishing mode of inheritance of, 74–75  
impact of, 6  
mouse models for, 7–8  
in newborn infants, 6  
presymptomatic testing for, 144  
screening for, 144–153, 152*b*

- treatment of, 87, 204–206  
 conventional approaches to, 205–206  
 drug treatment as, 205–206  
 protein/enzyme replacement, 205, 205t  
 tissue transplantation as, 206  
 from triplet repeat expansions, 18–19, 19t
- Genetic drift, random, 85, 85f
- Genetic effects, 21
- Genetic enhancement, 326
- Genetic heterogeneity, 317–318
- Genetic isolates, 87
- Genetic linkage, 89–91, 89f
- Genetic mapping. *see* Linkage analysis
- Genetic polymorphism, 88
- Genetic registers, 152  
 roles of, 152b
- Genetic research, informed consent in, 327, 327b
- Genetic short stature, 113–114
- Genetic susceptibility  
 approaches to demonstrating, 131–132  
 types and mechanisms of, 130
- Genetic testing, advantages and disadvantages of, 148b
- Genetics  
 advances in, 8  
 biochemical, 4  
 of cancer, 177–198, 199b  
 of common cancers, 186–188  
 community, 144  
 developmental, 102–129  
 discoveries that have led to Nobel Prize for Medicine or Physiology and/or Chemistry, 7t  
 early beginnings of, 1–2  
 ethical and legal issues in, 323–331  
 history of, 1–8, 8b  
 impact of, in medicine, 1–8, 8b  
 insurance and, 328  
 major new developments, 6–8  
 mathematical, 83–93  
 molecular, 5  
 multifactorial, 130–143, 143b  
 origins of, 4–6  
 pharmacogenetics, 200–213, 214b  
 population, 83–93  
 quantitative, 132  
 reproductive, 303–315, 316b  
 transplantation, 170
- Genetics clinic, ethical dilemmas in, 325–327
- Genitopatellar syndrome, 232, 233f
- Genitourinary malformations, 223b
- Genocopies, 71
- Genome(s)  
 fruit fly, 4  
 genetic code, 16, 16t  
 term, 3  
 thousand genomes project, 137
- Genome sequencing  
 advantages and disadvantages of, comparison with exome sequencing, 64t  
 as clinical diagnostic test, 64–65
- Genome-wide association (GWA) studies, 135–136, 136f–137f
- Genome-wide scan, 43
- Genomic imprinting, 77–80, 185
- Genomics  
 comparative, 46  
 functional, 46  
 Human Genome Project, 6–7
- Genotype  
 Hardy-Weinberg equilibrium for, 83  
 possible genotypes, phenotypes, and gametes formed from alleles at ABO locus, 75, 75t
- Genotype-phenotype correlations, 21  
 in cystic fibrosis, 287  
 in fragile X syndrome, 243t  
 in neurofibromatosis type 1, 280
- Genotype-Tissue Expression (GTEx) Project, 47
- Genotyper software, 52f
- Genotypes, determination of, 2, 2f
- Germline gene therapy, 207
- Germline mutations, 177, 181–183, 182f
- Gestational diabetes, 138
- Giemsa (G) banding, 24t, 26–27, 28f  
 G-banded metaphase spread, 28f  
 normal G-banded male karyotype, 27f
- Gigantism, cerebral, 221
- Gleevec (imatinib), 204, 204t
- Gli, 107
- GLI3* genes, 107, 112  
 developmental abnormalities associated with, 112t  
 in limb, as developmental model, 118  
 in position effects, 121t
- $\alpha$ -Globin  
 gene clusters, 12, 12f  
 gene structure, 156, 156f
- $\beta$ -Globin  
 gene clusters, 12, 12f  
 gene structure, 156f
- $\theta$ -Globin, gene structure, 156
- Globin chain, structure of, 155–156
- Globin gene  
 mapping, 155–156, 155f  
 structure, 156, 156f
- Glucose 6-phosphate dehydrogenase (G6PD)  
 deficiency in, 144t, 202  
 heterozygote advantage in, 88t  
 treatment for, 205t  
 variants in, 201–202
- Glutaric aciduria, type I, 87t, 258–259  
 neonatal screening for, 150t
- Glutaric aciduria II, 269
- Glycogen storage disorders (GSDs), 260–261
- Goldstein, Joseph, 7t
- Gonad dose, 21
- Gonadal mosaicism, 76, 98
- Gonadal tissue, 17
- Gorlin syndrome, 107, 109f, 119t, 182, 191t, 196t
- Gout, primary idiopathic, 265
- Graves' disease, HLA and, 170t
- Greengard, Paul, 7t
- Greider, Carol, 7t
- Greig cephalopolysyndactyly, 112, 113f
- Grieg syndrome, 107
- Griffith, Fred, 3–4
- Growth factor receptors, 181
- Growth factors, 181
- Growth hormone, biosynthetic, 206t
- GTAC. *see* Gene Therapy Advisory Committee (GTAC)
- Guthrie test, 150t  
 for phenylketonuria, 255–257
- GWAS studies. *see* Genome-wide association (GWA) studies
- ## H
- H-Y antigen, 170
- Hairy enhancer of split-7*, 106–107
- Hand-foot-genital syndrome, 108–109
- Haplo-insufficiency, 20
- Haplotype, 91, 170
- Haplotype Reference Consortium, 137
- HapMap project, 135
- Hardy, G. H., 83
- Hardy-Weinberg equilibrium  
 applications of, 86–87  
 factors that can disturb, 84–85  
 validity of, 85–86
- Hardy-Weinberg principle, 83, 83f–84f, 84t
- Hartwell, Leland, 7t
- HAX1* gene, 172
- Hb. *see* Hemoglobin (Hb)
- HCM. *see* Hypertrophic cardiomyopathy (HCM)
- HD. *see* Huntington disease (HD)
- Health Insurance Portability and Accountability Act, 328
- Hearing loss, sensorineural, inheritance pattern of, 317–318, 318t
- Hedgehog* (HH) gene family, 104
- Helix-loop-helix motif, 17
- Helix-turn-helix motif, 17
- Heme, 154
- Heme metabolism, disorders of, 266, 267f
- Hemochromatosis, 267–268  
 HLA and, 170t
- Hemoglobin electrophoresis, 151, 157f
- Hemoglobin (Hb), 154–162, 163b  
 chain termination, 157  
 control of expression of, 156  
 deletion, 156  
 developmental expression of, 154–155, 155f, 155t  
 disorders of, 156–161  
 synthesis of, 156–157  
 fetal, 161f  
 frameshift mutation, 157  
 functional abnormalities of, 157t  
 fusion polypeptides, 157  
 globin chain structure, 155–156  
 insertion, 156  
 point mutation, 156  
 protein analysis of, 154, 154f  
 protein studies, 155  
 structural variants of, 156–157, 157t  
 structure of, 154  
 synthesis of, 156  
 disorders of, 159–161  
 types of mutation, 156–157
- Hemoglobinopathies, 154–162, 163b  
 clinical variation of, 161, 162f  
 screening for, 162, 162f
- Hemolytic disease, of newborn, 175
- Hemophilia, 4, 71, 300–301, 300f  
 clinical features of, 300–301  
 genetics of, 301

- Hemophilia A, 144*t*, 300  
 'flip inversion, 301*f*  
 genetics of, 301  
 treatment for, 205*t*
- Hemophilia B, 144*t*, 300  
 genetics of, 301  
 Leyden, 301
- Hepatic glycogen phosphorylase deficiency (GSD VI), 261
- Hepatic porphyrias, 266
- Hepatitis B virus, 179*t*
- Hepatobiliary cancer, 196*t*
- Hepatoblastoma, chromosomal location of, 183*t*
- HER2* gene, 27–28
- Herceptin (trastuzumab), 204*t*
- Hereditary angio-edema, 171
- Hereditary conditions  
 acquired somatic genetic disease, 5  
 chromosome abnormalities, 4–5  
 multifactorial disorders, 5  
 single-gene disorders, 4
- Hereditary coproporphyrin, 266
- Hereditary fructose intolerance, 260
- Hereditary hemorrhagic telangiectasia, 288–289, 289*f*
- Hereditary motor and sensory neuropathies (HMSNs), 275–277  
 clinical features of, 275–276, 276*f*  
 forms of, 276*f*  
 genetics of, 276–277  
 HMSN type 4, 276  
 HMSN1a, 275–276, 277*f*  
 HMSN2, 276
- Hereditary neuropathy, with liability to pressure palsies, 276
- Hereditary non-polyposis colorectal cancer (HNPCC), 190–191, 190*f*, 196*t*
- Hereditary persistence of fetal hemoglobin, 161  
 mutational basis of, 161
- Hereditary sensory and autonomic neuropathies (HSANs), 277
- Hereditary spastic paraparesis (HSP), 277
- Hereditary spherocytosis, treatment for, 205*t*
- Heritability, 131
- Herpes simplex, 227*t*
- Heterodisomy, uniparental, 77
- Heteromorphism, 38
- Heteroplasmy, 81, 81*f*
- Heterotaxy, 112–113
- Heterozygosity, loss of, 183, 183*t*, 184*f*
- Heterozygote advantage, 84–85  
 of large populations, 87–88, 88*t*
- Heterozygote screening, 144
- Heterozygotes  
 double, 70–71, 75  
 manifesting, 72
- Heterozygous plants, 2
- Hexosaminidase, 145
- HFE* gene, mutation of, 56*f*
- High risk factors, 311
- Hippocrates, 1
- Hirschsprung disease, 119*t*
- Histone, chromosomal, 11
- History, of genetics, 1–8, 8*b*
- HLA system. *see* Human leukocyte antigen (HLA) system
- HMSNs. *see* Hereditary motor and sensory neuropathies (HMSNs)
- HNF1A* gene, mutations in, 202–203
- HNPCC. *see* Hereditary non-polyposis colorectal cancer (HNPCC)
- Hoagland, Mahlon, 4
- Hoffman-La Roche, 329
- Holandric inheritance, 71, 74
- Holley, Robert, 7*t*
- Holoprosencephaly, 107, 108*f*, 222–224
- Homeobox (*Hox*) genes, 107–109, 115–118
- Homocystinuria, 258, 259*f*  
 treatment for, 205*t*
- Homograft, 170
- Homologs, 25
- Homoplasmy, 81
- Homozygosity, 69–70, 183
- Homozygosity mapping, 43
- Homozygous plants, 2
- Hopi Indians, recessive disorders that are common in, 87, 87*t*
- Hormone nuclear receptors, 16
- Horritz, Robert, 7*t*
- 'Hotspots', 90
- Housekeeping genes, 16
- HOXA* gene, 118
- HOXA13* gene, 108–109
- HOXD* gene, 118
- HOXD10* gene, 108
- HOXD13* gene, 108–109
- HRAS* gene, 221*t*
- HSANs. *see* Hereditary sensory and autonomic neuropathies (HSANs)
- HSP. *see* Hereditary spastic paraparesis (HSP)
- HTT* gene, repeat expansions in, 19
- HUGO. *see* Human Genome Organization (HUGO)
- Human disease genes  
 historical strategies for, 42*t*  
 position-independent identification of, 42–43, 43*f*
- Human Fertilization and Embryology Act, 330, 330*b*
- Human gene maps, 45, 45*f*
- Human Genome Organization (HUGO), 44
- Human Genome Project, 6–7, 44–47, 329  
 ethical, legal, and social issues of, 46
- Human genome sequencing, 46
- Human leukocyte antigen (HLA) system, 170  
 associated diseases, 170*t*  
 loci of, alleles at, 170*t*  
 polymorphism, 170–171
- Humoral immunity, 164  
 innate, 165–166  
 specific acquired, 166–169
- Humoral specific acquired immunity, 166–169  
 disorders of, 172–173
- Hunt, Timothy, 7*t*
- Hunter syndrome (MPS II), 144*t*, 264, 264*f*
- Huntington disease (HD), 273–274  
 anticipation in, 76, 76*f*  
 clinical features of, 273–274  
 with delayed age of onset, 96, 96*f*  
 genetics of, 274
- myotonic dystrophy and, comparison of, 274*t*  
 natural history of, 273*f*  
 triplet repeat expansions and, 19*t*
- Hurler syndrome (MPS I), 263–264
- Hutchinson-Gilford progeria, 66–68
- Hydatidiform moles, 121, 121*t*
- Hydrocephalus, 220*t*
- Hydrops fetalis, 159, 240*f*
- 21-Hydroxylase deficiency, HLA and, 170*t*
- Hyper-IgE syndrome, 173
- Hyper-IgM syndrome, 172
- Hypercholesterolemia  
 autosomal recessive familial, gene therapy for, 208  
 familial, 262–263, 262*f*–263*f*  
 treatment for, 205*t*
- Hyperphenylalaninemia, 257
- Hyperplasia, congenital adrenal, treatment for, 205*t*
- Hypertelorism, 228*f*
- Hyperthermia  
 malignant, 202  
 treatment for, 205*t*  
 prolonged, 227
- Hypertrophic cardiomyopathy (HCM), 290
- Hypervariable minisatellite DNA, 13
- Hypervariable regions, 168
- Hypochondropia, 113–114, 113*t*
- Hypomelanosis of Ito, 239, 239*f*
- Hypomorph, 20
- Hypophosphatemia, X-linked, 73
- Hypothyroidism, congenital  
 neonatal screening for, 150–151  
 treatment for, 205*t*
- I**
- ICCs. *see* Inherited cardiac conditions (ICCs)
- Ichthyosis, inheritance pattern of, 318*t*
- ICRs. *see* Imprinting control regions (ICRs)
- ICSI. *see* Intracytoplasmic sperm injection (ICSI)
- Idiogram, 27, 27*f*
- IgA. *see* Immunoglobulin A (IgA)
- IgD. *see* Immunoglobulin D (IgD)
- IgE. *see* Immunoglobulin E (IgE)
- IgG. *see* Immunoglobulin G (IgG)
- IgM. *see* Immunoglobulin M (IgM)
- IHC. *see* Immunohistochemistry (IHC)
- IKK-gamma* gene, 171
- Imatinib (Gleevec), 204, 204*t*
- Immediate family, implications for, 326–327
- Immune complex clearance, 166
- Immunity, 164  
 cell-mediated innate, 164–165  
 humoral innate, 165–166  
 humoral specific acquired, 166–169  
 innate, 164–166  
 primary inherited disorders of, 171–173  
 specific acquired, 166–171
- Immunodeficiency  
 associated, 173–174  
 inherited, 171–174  
 X-linked, 174, 174*f*
- Immunogenetics, 164–175, 176*b*
- Immunoglobulin A (IgA), 167, 167*t*
- Immunoglobulin D (IgD), 167, 167*t*



- Immunoglobulin E (IgE), 167, 167t  
 Immunoglobulin G (IgG), 167, 167t  
 Immunoglobulin M (IgM), 167, 167t  
 Immunoglobulins, 167  
   allotypes, 167  
   classes of, 167, 167t  
   gene superfamily, 169  
   heavy-chain gene rearrangement, 168–169, 168f  
   isotypes, subclasses, and isotypes, 167  
   structure of, 167  
 Immunohistochemistry (IHC), 190–191  
 Immunological memory, 167  
 Immunoreactive trypsin, 151  
 Imprinting control regions (ICRs), 77  
 Imprints, 102–103  
 In vitro fertilization (IVF), 313–314  
 Inadvertent testing, 326–327  
 Inborn errors of metabolism, 4, 255–271, 272b  
   classification of, 256t  
   prenatal diagnosis of, 271  
 Incest, 321  
   frequency of abnormality in children of, 321t  
   risk of abnormality in offspring of, 321t  
 Incidence, 5  
 Incidental findings, ethical dilemmas and, 327, 328b  
 Incomplete ascertainment, 88–89  
 Incontinentia pigmenti, 73, 74f  
 Independent assortment, 3  
 Index case, 66  
 Indirect method, of mutation rates  
   estimation, 86–87  
 Individualized medicine, 202  
 Induced pluripotent stem cell (iPS), 210  
 Induced pluripotent stem cell therapy, 213  
 Infants  
   development of, 102, 102t  
   newborn, 6  
 Infections  
   maternal, 226–227  
   teratogenic effects, 226, 227t  
 Infertility, 254  
 Inflammation, 166  
 Informed choice, 324  
 Informed consent, 324–325  
   in genetic research, 327, 327b  
   signed, 324  
 Inheritance  
   autosomal, 66  
   autosomal dominant, 66–70, 68f, 74  
     features that support, 75b  
     genetic risks in, 66, 68f  
     risk calculation with, 95–97  
     segregation analysis of, 88  
   autosomal recessive, 70–71, 70f, 74  
     features that support, 75b  
     genetic risks in, 70, 70f  
     risk calculation with, 97–98, 97f  
     segregation analysis of, 88–89, 89t  
   cellular basis of, 9–22, 23b  
   chromosomal basis of, 3  
   digenic, 75  
   DNA as the basis of, 3–4  
   establishing mode of, 74–75, 75b  
   laws of, 1–3  
   mendelian, 66–75  
   mitochondrial, 80–81, 81f  
   molecular basis of, 9–22  
   multifactorial, 130  
   patterns of, 66–82, 82b, 317–318, 318t  
   polygenic, 4, 132  
   quantitative, 5  
   sex-linked, 66, 71–74  
   sex-linked recessive, risk calculation with, 98–99, 98f  
   unifactorial, 66  
   X-linked dominant, 73–75, 73f–74f, 75b  
   X-linked recessive, 71–75, 71f, 75b  
     genetic risk in, 71, 71f–72f  
   Y-linked or holandric, 74–75, 75b  
 Inherited cancer-predisposing syndromes, 193–194  
 Inherited cancer syndromes, 189–191  
 Inherited cardiac conditions (ICCs), 289–291  
   arrhythmias, 289–290, 290t  
   cardiomyopathies, 290–291  
 Inherited family cancer syndromes, 191t  
 Inherited immunodeficiency disorders, 171–174  
 Inherited susceptibility, for common cancers, 194  
 Innate immunity, 164–166  
   cell-mediated, 164–165  
   disorders of, 171  
   humoral, 165–166  
 Insertional mutagenesis, 207–208  
 Insertions, 18–19, 18t, 37  
 Insulin, biosynthetic, 206t  
 Insulin-dependent diabetes, HLA and, 170t  
 Insulin-like growth factor 2 (*IGF2*) gene, 79  
 Insulin secretion, 203, 203f  
 Insurance, genetics and, 328, 328b  
 Intellectual impairment, 321t  
 Interferon, 165  
 $\beta$ -Interferon, biosynthetic, 206t  
 Interleukin-1 receptor (IL-1R) pathways, 164–165, 165f  
 International HapMap project, 135  
 Interphase, 30, 30f  
 Intracellular signal transduction factors, 181  
 Intracytoplasmic sperm injection (ICSI), 313–314  
 Inversions, 37–39  
   paracentric, 39, 39f  
   pericentric, 38–39, 39f  
 Ion semiconductor sequencing, 57–58  
 Ionizing radiation, 21  
   average doses, 21, 21t  
   teratogenic effects of, 227  
 iPS. *see* Induced pluripotent stem cell (iPS)  
 IRAK4, 171  
 Iressa (gefitinib), 204, 204t  
 Iron metabolism, disorders of, 267–268  
 Isochromosomes, 39–40  
 Isolated case, 98, 99f  
 Isomerism sequence, 112–113  
 Isoniazid, acetylation of, 201f  
 Isovaleric acidemia, 150t  
 Isozymes, 88  
 Ito, hypomelanosis of, 239, 239f  
 Ivacaftor, 206  
 Ivemark syndrome, 112–113  
 IVF. *see* In vitro fertilization (IVF)
- J**  
 Jacob, François, 7t  
*JAGGED1* gene, 106–107, 107f  
 Janssens, Alfons, 3  
 Jaundice, congenital non-hemolytic, treatment for, 205t  
 Jeffreys, Alec, 52  
 Jervell and Lange-Nielsen syndrome, 289  
 Jeune asphyxiating thoracic dystrophy, 117t  
 Joining (J) region, 168  
 Joint hypermobility, 294  
   Beighton score for, 295t  
 Joint probability, 94, 98  
 Jonson framework, 324, 324b  
 Joubert syndrome, 117t  
 Junk DNA, 12  
 Justice, 323b  
 Juvenile polyposis syndrome, 182, 191t, 192
- K**  
*KAI1* gene, 193  
 Kabuki syndrome, 230, 232f  
 Kandel, Eric, 7t  
 Kanner, Dr. Leo, 229  
 Kappa ( $\kappa$ ) chain, 167, 168f  
 Karaite Jews, recessive disorders that are common in, 87t  
 Kartagener syndrome (primary ciliary dyskinesia), 112–113, 117t  
 Karyogram, 27  
 Karyotype, 26  
   normal G-banded male karyotype, 27f  
   preparation of, 26f  
   symbols used in describing, 29t  
 Karyotype analysis, 27  
*KAT6B* gene, 232  
*KCNJ11* gene, 203  
*KCNQ1* gene, 79  
 KCNQ2-associated early infantile epileptic encephalopathy, 234, 235f  
 Kennedy disease, 19t  
 Khorana, Gobind, 7t  
 Kidney disease, polycystic, 117t  
   inheritance pattern of, 318t  
   tissue transplantation for, 206  
   treatment for, 205t  
*KIT* gene, 119t  
   mutations of, 181  
 Klinefelter syndrome (47, XXY), 4–5, 239–240  
   chromosome findings in, 240  
   clinical features of, 240  
 ‘Knight’s move’ pattern of transmission, 71  
 Kostmann disease, 172  
*KRAS* gene, 221t  
   mutations in Noonan syndrome of, 221  
 Kugelberg-Welander disease, 278
- L**  
 Lactic acidosis, 271  
 LAD. *see* Leukocyte adhesion deficiency (LAD)  
 Lambda ( $\lambda$ ) chain, 167, 168f

- Laterality defects, 112  
 Law of independent assortment, 3  
 Law of segregation, 3  
 Law of uniformity, 3  
 Laws of addition, 94  
 Laws of inheritance, 1–3  
 Laws of multiplication, 94  
 LDS. *see* Loews-Dietz syndrome (LDS)  
 Learning difficulties  
   family history of, 311  
   neurodevelopmental disorders and, 253  
 Learning disability, 229–235, 235*b*  
   incidence of, 215–216  
 Leber congenital amaurosis, 117*t*  
   gene therapy for, 208–209  
 Leber hereditary optic neuropathy (LHON), 271  
 Legal issues, in medical genetics, 323–331, 331*b*. *see also* Ethical issues  
 Legius syndrome, 280  
 Leigh disease, 271  
 Lemon sign, ultrasonographic image, 307, 307*f*  
 Lentiviruses, 209  
 Leptotene, 31, 31*f*  
 Leri-Weil dyschondrosteosis, 74  
 Lesch-Nyhan syndrome, 265  
   fibroblasts, 144*t*  
 Leucine zipper, 17  
 Leukemia  
   chronic myeloid, 180, 180*f*  
   oncogenes in, 179  
 Leukocyte adhesion deficiency (LAD), 172  
 Lewis, Edward, 7*t*  
 LGMDs. *see* Limb-girdle muscular dystrophies (LGMDs)  
 LHON. *see* Leber hereditary optic neuropathy (LHON)  
 Li-Fraumeni syndrome, 185, 191*t*  
   screening for, 196*t*  
   tumor suppressor mutations in, 187*t*  
 Liability/threshold model, 133–134  
 Licenses for assisted conception, 314, 314*b*  
 Life insurance, 328  
 Limb, as developmental model, 115–119, 120*f*  
   initiation and specification of, 115–118  
   tissue differentiation and growth in, 118–119, 121*f*  
 Limb bud formation, 115–118  
 Limb deformities, congenital, 228, 228*f*  
 Limb-girdle muscular dystrophies (LGMDs), 66–68, 282*f*, 284  
 Linkage analysis, 43–44, 90  
   of multifactorial disorders, 134  
   multipoint, 91, 91*f*  
 Linkage disequilibrium, 43, 91  
 Linked markers, 145  
   risk calculation with, 99, 99*f*  
 Lipid metabolism, 140  
   disorders of, 262–263  
   single-gene disorders of, leading to coronary artery disease, 140  
 Lipoid proteinosis, 87*t*  
 Lipoprotein metabolism, disorders of, 262–263  
 Liposome-mediated gene therapy, 209–210, 209*f*  
 Lisch nodules, in neurofibromatosis type 1 (NF1), 279*f*  
 Lithium, teratogenic effects of, 225*t*  
 Liver, gene therapy for, 208  
 LMNA gene, 66–68  
   genotype-phenotype correlation, 21  
 Localization sequences, 15  
 Locus heterogeneity, 70–71  
 LOD (logarithm of the odds) scores, 90–91, 90*f*  
 Loews-Dietz syndrome (LDS), 293, 293*f*  
 LOH. *see* Loss of heterozygosity (LOH)  
 LOI. *see* Loss of imprinting (LOI)  
 Long-chain 3-hydroxyacyl-CoA dehydrogenase deficiency, 150*t*, 269  
 Long-chain acyl-CoA dehydrogenase deficiency, 269  
 Long interspersed nuclear elements, 13  
 Long QT syndromes (LQTS), 289  
 Loss-of-function mutations, 20, 119–120  
 Loss of heterozygosity (LOH), 183, 183*t*, 184*f*  
 Loss of imprinting (LOI), 185  
 Lou Gehrig disease. *see* Amyotrophic lateral sclerosis (ALS)  
 Lowe syndrome, 144*t*  
 LQTS. *see* Long QT syndromes (LQTS)  
 Lunatic fringe, 105–106  
 Lung carcinoma, chromosomal location of, 183*t*  
 Lwoff, André, 7*t*  
 Lynch syndrome, 190–193  
   mismatch repair genes associated with, 191*t*  
   screening for, 196*t*  
 Lyon, Mary, 122  
 Lyonization, 122  
 Lysis, 166  
 Lysosomal storage disorders, 263–265  
 Lysosomes, 9  
**M**  
 MAC. *see* Membrane attack complex (MAC)  
 Machado-Joseph disease, 19*t*  
 MacLeod, Colin, 3–4  
 Madelung deformity, 74  
 Major histocompatibility complex, 170  
 Malformations. *see also specific malformations*  
   cardiac, 223*b*  
   central nervous system, 223*b*  
   congenital, 5, 321*t*  
   that show multifactorial inheritance, 130*b*  
   definition and classification of, 216–217  
   examples of, 216*f*  
   genetic causes of, 219–225  
   genitourinary, 223*b*  
   of unknown cause, 228  
 Malignancy, 254  
 Malignant hyperthermia, 202  
   treatment for, 205*t*  
 Manchester Scoring System, 195*t*  
 Mandibuloacral dysplasia, 66–68  
 Mannose-binding protein, 165, 165*f*  
 Map unit, 90  
 MAP2K1 gene, 221*t*  
 MAP2K2 gene, 221*t*  
 Maple syrup urine disease, 260  
   neonatal screening for, 150*t*  
   treatment for, 205*t*  
 Mapping  
   autozygosity, 43, 91, 92*f*  
   globin gene, 155–156, 155*f*  
   homozygosity, 43  
 Mapping trinucleotide repeat disorders, 43  
 Marfan syndrome (MFS), 291–293, 292*f*  
   clinical features of, 292–293  
   genetics of, 293  
   Ghent criteria, 291*t*  
   revised, 292*t*  
   presymptomatic diagnosis of, 146  
 Marker chromosome, presence of, 312  
 Maroteaux-Lamy syndrome (MPS VI), 264  
 Marriage, consanguineous, 320, 320*t*  
 MASP. *see* MBL-associated serine protease (MASP)  
 Mast cell leukemia, 119*t*  
 Maternal age effect, 34  
 Maternal chromosomes, 35  
 Maternal epilepsy, 227–228  
 Maternal infections, 226–227  
 Maternal phenylketonuria, 257–258  
 Maternal serum  $\alpha$ -fetoprotein (MSAFP) levels  
   causes of raised, 307–308, 308*b*  
   for prenatal screening, 307, 307*f*  
 Maternal serum screening, 307  
 Mathematical genetics, 83–93, 93*b*  
 Mating  
   assortative, 84  
   non-random, 84  
   random, 84  
 Maturity-onset diabetes of the young, 202–203, 203*f*  
 Maximum likelihood method, 90  
 MBL-associated serine protease (MASP), 165–166  
 MBL2 gene, 166  
 MCAD deficiency. *see* Medium chain acyl-CoA dehydrogenase (MCAD) deficiency  
 McArdle disease (GSD V), 261  
 McCarty, Maclyn, 3–4  
 McClintock, Barbara, 7*t*, 13  
 MCKD. *see* Medullary cystic kidney disease (MCKD)  
 McKusick, Victor, 4, 5*f*  
 McKusick-Kaufman syndrome, 117*t*  
 ‘McKusick’s Catalog’, 4, 5*f*  
 McLeod phenotype, 44  
 Meckel-Gruber syndrome, 117*t*  
 Meckel syndrome, 220*t*  
 Medical genetics  
   ethical issues in, 323–331  
   legal issues in, 323–331  
   origins of, 4–6  
 Medical intervention, 92–93  
 Medium chain acyl-CoA dehydrogenase (MCAD) deficiency, 269  
   neonatal screening for, 150*t*  
 Medullary cystic kidney disease (MCKD), 297–298, 297*f*  
 Medulloblastoma, 196*t*  
 Megalencephaly, 220*t*

- Meiosis, 30–32  
 consequences of, 32  
 segregation at, 34*f*, 35, 38–39, 89*f*  
 stages of, 30, 31*f*
- Meiosis I, 30–32
- Meiosis II, 32
- Meiotic drive, 88
- Melanoma, chromosomal location of, 183*t*
- MELAS (mitochondrial encephalomyopathy, lactic acidosis, and stroke-like episodes), 271
- Mello, Craig, 7*t*
- Melnick-Needles syndrome, 66–68
- Membrane attack complex (MAC), 166
- Mendel, Gregor, 1–3, 2*f*  
 breeding experiments, 2, 2*f*  
 plant experiments, 2
- Mendelian, term, 2
- Mendelian inheritance, 66–75, 75*b*
- Meningioma, chromosomal location of, 183*t*
- Menkes disease, 266–267
- Mental Capacity Act, 324–325, 325*b*
- Mental retardation, SETD5-associated, 234, 235*f*
- MERRF. *see* Myoclonic epilepsy and ragged red fiber disease (MERRF)
- Merrick, Joseph, 279
- Mesenchymal stem cell therapy, 213
- Mesoderm, 114–115
- Mesoderm posterior-2*, 106–107
- Mesodermal structures, 103
- Messenger RNA (mRNA), 14  
 splicing, 14–15, 14*f*  
 splicing mutations in  $\beta$ -thalassemia, 160
- Metabolic pathways, 9
- Metabolism, inborn errors of. *see* Inborn errors of metabolism
- Metabolomics, 46
- Metachromatic leukodystrophy (MLD), 265
- Metals, metabolism of, disorders of, 266–268
- Metaphase, 29, 30*f*
- Metaphase I, 32
- Metaphase spreads, 27, 28*f*
- Methemoglobin, 157
- Methylation, 77, 122  
 of DNA, 185, 186*f*  
 gain of, 79–80  
 loss of, 79–80
- Methylenetetrahydrofolate reductase* (MTHFR) gene, 224
- Methylglutaconic aciduria, 260
- Methylmalonic acidemia, treatment for, 205*t*
- Methylmalonic acidurias, 259–260
- MFS. *see* Marfan syndrome (MFS)
- Microarray CGH, 5, 62, 64*f*, 245–250  
 for dosage analysis, 62  
 indications for, 253–254, 253*b*
- Microarrays, DNA, 54
- Microcephaly, 220*t*  
 inheritance pattern of, 318*t*
- Microdeletion, 27–28
- Microdeletion syndromes, 27–28, 245–250, 245*t*
- Micrognathia, ultrasonographic image, 304*f*
- Microphthalmia, 220*t*
- MicroRNAs (miRNAs), 17
- Microsatellite DNA, 13
- Microsatellite instability (MSI), 190
- Microsatellites, 52, 52*f*
- Microtubules, 29
- MIF. *see* Müllerian inhibiting factor (MIF)
- Migration, 85, 104
- Minisatellite DNA, 13
- Minisatellites, 52
- miRNAs. *see* MicroRNAs (miRNAs)
- Miscarriage  
 recurrent, 254  
 spontaneous, 6, 215
- Mismatch repair genes, 190–191  
 associated with Lynch syndrome, 191*t*
- Mismatch repair (MMR), 22, 22*t*
- Missense mutations  
 effects on protein product, 18*t*  
 frequency of, 18*t*  
 non-synonymous, 20  
 $\beta$ -thalassemia, 160
- Missing heritability, 137
- MITF* gene, 109
- Mitochondria, 9
- Mitochondrial DNA, 13–14, 14*f*
- Mitochondrial encephalomyopathy, lactic acidosis, and stroke-like episodes (MELAS), 271
- Mitochondrial fatty acid oxidation, disorders of, 269
- Mitochondrial inheritance, 80–81, 81*f*
- Mitochondrial respiratory chain disorders, 269–271, 270*f*
- Mitofusin 2 (*MFN2*), 276
- Mitoses, 5
- Mitosis, 29, 30*f*
- Mitotic cell divisions, lineage of, 178*f*
- Mixoploidy, 40
- MLD. *see* Metachromatic leukodystrophy (MLD)
- MLPA. *see* Multiplex ligation-dependent probe amplification (MLPA)
- MMR. *see* Mismatch repair (MMR)
- MND. *see* Motor neuron disease (MND)
- Molecular cytogenetics, 27–28
- Molecular genetics, 5
- Monod, Jacques, 7*t*
- Monogenic disorders, 273–302, 302*b*  
 blood, 298–301  
 connective tissue, 291–295  
 genetic etiology of, 47–48  
 identifying genes for, 42–48, 49*b*  
 laboratory techniques for, 50–65, 50*b*  
 DNA sequence polymorphisms for, 50–52  
 dosage analysis in, 60–62  
 mutation detection and, 54–56, 54*t*  
 PCR (polymerase chain reaction) for, 50  
 sequencing-based methods in, 57–58  
 neurocutaneous, 278–281  
 neurological, 273–274  
 renal, 296–298  
 respiratory, 286–289
- Monosomy, 34–35
- Monozygotic twins, 128, 128*t*
- Morgan, Thomas, 3
- Morphogenesis, 215
- Morquio syndrome (MPS IV), 264
- Mosaicism, 40, 76, 123, 124*f*, 311  
 definition of, 40  
 gonadal, 76, 98  
 level 1, 311  
 level 2, 311  
 level 3, 311  
 reason for, 311  
 somatic, 40, 40*f*, 76  
 true fetal, 311
- Motor neuron disease (MND), 278  
 diagnostic criteria for, 278*b*
- Mowat-Wilson syndrome, 230–231, 232*f*
- mRNA. *see* Messenger RNA (mRNA)
- MSI. *see* Microsatellite instability (MSI)
- MSX2* gene, 109
- mTOR signaling pathway, 282*f*
- Mucopolysaccharidoses, 263–264, 264*f*  
 treatment of, 264
- Muir-Torré syndrome, 191*t*
- Mulibrey nanism, 87*t*
- Müllerian inhibiting factor (MIF), 124–125, 170
- Multifactorial disorders, 5  
 discontinuous, 133  
 disease models for, 137–143  
 empiric recurrence risks for, 100, 100*t*  
 identifying genes that cause, 134–137
- Multifactorial genetics, 130–143, 143*b*  
 hypothetical liability curves in, 134*f*, 143*b*
- Multifactorial inheritance  
 of congenital abnormalities, 222, 223*b*  
 disorders that show, 130*b*, 131*f*  
 liability/threshold model of, 133–134
- Multigene families, 12
- Multiple acyl CoA dehydrogenase deficiency, 269
- Multiple alleles, 75
- Multiple congenital abnormalities, 253
- Multiple displacement amplification, 313
- Multiple endocrine neoplasia, 191*t*, 198*t*  
 type 2A, 119*t*, 120  
 type 2B, 119*t*, 120  
 type I, 183*t*, 196*t*  
 type II, 187*t*, 196*t*
- Multiple myeloma, 168
- Multiplex ligation-dependent probe amplification (MLPA), 62, 62*f*–63*f*
- Multiplication, laws of, 94
- Multipoint linkage analysis, 91, 91*f*
- Muscle, gene therapy for, 208
- Muscular dystrophies, 281–286  
 Becker, 281–284, 282*f*–283*f*  
 Duchenne, 281–284, 282*f*  
 Emery-Dreifuss, 66–68  
 facioscapulohumeral (FSHD), 282*f*, 284–285, 284*f*–285*f*  
 limb girdle, 66–68  
 limb-girdle (LGMD), 282*f*, 284  
 myotonic dystrophy type 1 (MD1), 285–286, 285*f*  
 myotonic dystrophy type 2 (MD2), 286  
 oculopharyngeal, 19*t*  
 Xp21, 281–284
- Mutagenesis, 21–22
- Mutagenic potential, 87
- Mutagens, chemical, 21–22
- Mutation analysis, 97–98

- Mutation rate ( $\mu$ ), 87, 98  
 estimation of, 86–87
- Mutational heterogeneity, 71
- Mutations, 17–21  
 back, 17  
 definition of, 17  
 detection of, 54–56, 54*t*  
 PCR-based methods of, 55–56  
 sequencing-based methods, 57–58  
 dominant-negative, 20–21  
 dynamic, 18–19, 18*t*  
 frameshift, 18*t*, 20  
 frequency of, 18*t*  
 functional effects of, on protein, 20–21  
 gain-of-function, 20, 119–120  
 germline, 177, 181–183, 182*f*  
 haplo-insufficiency, 20  
 and Hardy-Weinberg equilibrium, 84  
 loss-of-function, 20, 119–120  
 missense, 18*t*, 20  
 new, 69  
 nomenclature for, 18*t*  
 in noncoding DNA, 20  
 nonsense, 18*t*, 20  
 nonsynonymous, 19–20  
 point, 180–181  
 promoter, 18*t*  
 repeat expansions, 18–19  
 signatures, 188–193, 189*f*  
 silent, 18*t*, 19  
 somatic, 17, 182–183  
 splice site, 18*t*  
 splicing, 20  
 spontaneous, 21  
 structural effects of, on protein, 19–20  
 synonymous, 19  
 types of, 17–18, 18*t*
- MX11* gene, 193
- Myasthenia gravis, HLA and, 170*t*
- MYC* oncogene, 180
- Myelin protein zero, 276
- Myeloid leukemia, chronic, 180, 180*f*
- Myelomeningocele, thoracolumbar, 217*f*
- MYH polyposis, 191–193
- Myoclonic epilepsy and ragged red fiber disease (MERRF), 270–271
- Myotonic dystrophy  
 Huntington disease and comparison of, 274*t*  
 type 1 (MD1), 19*t*, 285–286, 285*f*  
 clinical features, 285–286, 285*f*  
 genetics, 286  
 type 2 (MD2), 19*t*, 286
- Myriad Genetics, 329
- N**
- NAIP* genes, 278*f*
- Narcolepsy, HLA and, 170*t*
- NARP. *see* Neurodegeneration, ataxia, and retinitis pigmentosa (NARP)
- NAT1* gene, 201
- NAT2* gene, 201
- Nathans, Daniel, 7*t*
- National DNA Database, 328–329
- NATP* pseudogene, 201
- Natural History Society of Brünn, 2
- Natural killer (NK) cells, 165
- NEMO, 171
- Neonatal death, unexplained, 254
- Neonatal diabetes, 203
- Neonatal screening, for  $\alpha_1$ -Antitrypsin deficiency, 150
- Nephrogenic diabetes insipidus, 298
- Nephronophthisis, 117*t*, 297–298, 297*f*
- Neural crest, 114–115
- Neural tube defects, 216–217, 217*f*, 224–225, 224*f*, 307–308  
 empiric recurrence risks for, 100, 100*t*  
 maternal serum AFP screening for, 307, 307*f*
- Neurocristopathies, 103
- Neurocutaneous disorders, monogenic, 278–281
- Neurodegeneration, ataxia, and retinitis pigmentosa (NARP), 271
- Neurodevelopmental disorders, 253
- Neurofibromata, 279, 279*f*
- Neurofibromatosis, 182  
 type 1 (NF1), 279–280, 279*f*  
 chromosomal location of, 183*t*  
 clinical features, 279  
 genetics, 279–280  
 linked DNA markers for, 146  
 Lisch nodules in, 279*f*  
 tumor suppressor mutations in, 187*t*  
 type 2 (NF2), 280  
 chromosomal location of, 183*t*
- Neurofibromin-1* gene, 280
- Neurofibromin-2* gene, 280
- Neurological disorders, monogenic, 273–274
- Neutropenias, 172
- Nevoid basal cell carcinoma, 107, 109*f*, 182, 191*t*, 196*t*
- New mutations, 69
- Newborn bloodspot screening, 149–150, 149*t*–150*t*, 255–257
- Newborn hearing screening, 151
- Newborn infants  
 genetic disease in, 6  
 incidence of anomalies in, 215–216  
 neonatal diabetes, 203
- Newborn screening, 149–150, 329–330
- Next-generation ‘clonal’ sequencing, comparison with Sanger sequencing, 58*t*
- Next-generation sequencing, 57–58, 60*f*–61*f*  
 for dosage analysis, 62
- NF $\kappa$ B signaling. *see* Nuclear factor kappa-B (NF $\kappa$ B) signaling
- Niemann-Pick disease, 265
- NIPT. *see* Non-invasive prenatal testing (NIPT)
- Nireberg, Marshall, 7*t*
- NK cells. *see* Natural killer (NK) cells
- N-MYC, 180
- Nobel Prize for Medicine or Physiology, 10
- Nobel Prize for Medicine or Physiology and/or Chemistry, 7*t*
- Nodal* family, 104
- Nomenclature  
 chromosome, 28–29, 29*f*  
 complement, 165–166  
 for mutations, 18*t*
- Non-disjunction, 33–34, 34*f*  
 cause of, 34  
 origin of, 34, 34*t*
- Non-invasive prenatal testing (NIPT), 314–315
- Non-maleficence, 323*b*
- Non-maternity, 69
- Non-paternity, 69, 321, 321*f*
- Non-penetrance, 69, 95
- Nonsense-mediated decay, 20
- Nonsense mutations  
 effects on protein product, 18*t*  
 frequency of, 18*t*  
 non-synonymous, 20
- Noonan syndrome, 220–221, 221*f*
- Normal distribution, 132*f*  
 human characteristics that show a, 132, 133*f*  
 polygenic inheritance and, 132–133, 132*b*
- Northern blotting, 54
- NOTCH2*, 106–107
- Notch-delta signaling, 105–106, 105*f*
- Notch receptor*, 106–107
- NT. *see* Nuchal translucency (NT)
- Nuchal thickening, ultrasonographic image, 304*f*
- Nuchal translucency (NT), 303
- Nuclear envelope, 9
- Nuclear factor kappa-B (NF $\kappa$ B) signaling, defects in, 171–172
- Nuclear genes, 12
- Nuclear pores, 9
- Nuclear proteins, DNA-binding, 181
- Nucleic acid  
 composition of, 9  
 types of, 9
- Nucleic acid hybridization, 53–54  
 techniques in, 52–54
- Nucleic acid probes, 52–53
- Nucleolus, 9
- Nucleosomes, 11
- Nucleotide excision repair, 22, 22*t*
- Nucleotide metabolism, disorders of, 266
- Nucleotides, 9
- Null allele, 20
- Nullisomy, 34–35, 77
- Numerical abnormalities, 33–35
- Numerical X-chromosome abnormalities, 73
- Nurse, Paul, 7*t*
- Nüsslein-Volhard, Christiane, 7*t*
- O**
- OAVS. *see* Oculo-auriculovertebral spectrum (OAVS)
- Obligate carriers, 71, 94
- Ocular albinism, 123, 144*t*
- Oculo-auriculovertebral spectrum (OAVS), 117*t*
- Oculocutaneous albinism, 257*f*–258*f*, 258  
 heterogeneity of, 258
- Oculopharyngeal muscular dystrophy, 19*t*
- Odds ratio, 99, 134–135, 135*t*
- Odontogenic keratocysts, 196*t*
- OFD syndromes. *see* Oro-facial-digital (OFD) syndromes
- Ohtahara syndrome, 234, 235*f*
- Okiihiro syndrome, 118, 225–226
- Oligohydramnios, 217, 219*f*
- Oligonucleotide ligation assay, 56, 57*f*
- Oligonucleotides, antisense, 210

- OMIM. *see* Online Mendelian Inheritance in Man (OMIM)
- Oncogenes, 179–182  
 amplification of, 180  
 at chromosomal translocation breakpoints, 179–180  
 detection of, by DNA transfection studies, 180–181  
 function of, 181, 181*f*  
 identification of, 179–181  
 types of, 181–182
- One gene-one enzyme concept, 255
- Online Mendelian Inheritance in Man (OMIM), 4
- Oocytes, 32
- Oogenesis, 32, 33*f*
- OPD syndrome. *see* Oto-palato-digital (OPD) syndrome
- Oposonisation, 166
- Options, discussing, 319
- Organic acidurias, 258–260
- Oro-facial-digital (OFD) syndromes, 117*t*  
 type 1, 117*t*
- Orotic aciduria, 266
- Orthologous gene, 42
- Oscillation clock, 105–106
- Osler-Weber-Rendu disease. *see* Hereditary hemorrhagic telangiectasia
- Osteosarcoma, chromosomal location of, 183*t*
- Oswald, Avery, 3–4
- Oto-palato-digital (OPD) syndrome, 66–68, 117*t*
- Ovarian cancer, 193  
 chromosomal location of, 183*t*  
 epithelial, 193  
 screening for, 196*t*, 197–198  
 treatment for, 198*t*
- Overgrowth syndromes, 221
- P**
- p53 protein, 183
- p105-Rb protein, 183
- Pachytene, 31*f*, 32
- PAH. *see* Pulmonary arterial hypertension (PAH)
- Paint probes, whole-chromosome, 28
- Painter, Theophilus, 3
- Painting, chromosomes, 28, 28*f*
- Paired-box (*PAX*) gene, 109, 109*t*
- Pallister-Hall syndrome, 107, 112, 112*t*, 113*f*
- Pancreatic beta cells, 203, 203*f*
- Pancreatic cancer, chromosomal location of, 183*t*
- 'Pangenes', 2
- Panmixis, 84
- Papilloma virus, 179*t*
- Paracentric inversions, 39, 39*f*
- Paralogous human gene, 42
- Parathyroid adenoma, 196*t*
- Parker, Mike, 324, 324*b*
- Partial hydatidiform mole, 121
- Partial sex-linkage, 74
- Patau syndrome (trisomy 13), 33, 238, 239*f*
- Patched (*Ptch*), 107, 108*f*
- Patched* (*PTCH*) gene, 119*t*
- Patenting, gene, 329
- Paternal chromosomes, 35
- Patient support groups, 319
- Patterning, early, 104–105
- PAX2* gene, 109, 109*t*
- PAX3* gene, 42–43, 109, 109*t*, 119*t*, 121
- PAX6* gene, 109, 109*t*, 121*t*, 243–244, 244*f*
- PCR. *see* Polymerase chain reaction (PCR)
- Pedigree drawing, 66
- Pelizaeus-Merzbacher disease, 277
- Peptide metabolism, disorders of, 255–260
- Pericentric inversions, 38–39, 39*f*
- Perinatal mortality, and congenital abnormalities, 215
- Peripheral myelin protein-22 (*PMP22*), 276, 277*f*
- Peripheral neuropathies, inherited, 275–278  
 hereditary motor and sensory neuropathies, 275–277  
 hereditary sensory and autonomic neuropathies (HSAN), 277  
 hereditary spastic paraparesis (HSP), 277  
 spinal muscular atrophy (SMA), 277–278
- Peripherin* gene, 75
- Peroneal muscular atrophy, 275
- Peroxisomal disorders, 268–269
- Peroxisomes, 9
- Person-centered approach, in genetic counseling, 319
- Personalized medicine, 202–204
- Peutz-Jegher syndrome (PJS), 182, 191*t*, 192, 192*f*
- Pfeiffer syndrome, 113–114, 113*f*, 113*t*
- PGD. *see* Preimplantation genetic diagnosis (PGD)
- Phagocytosis, 164, 164*f*
- Phakomatoses, 182
- Pharmacodynamics, 200
- Pharmacogenetics, 200–213
- Pharmacogenomics, 6, 200, 203
- Pharmacokinetics, 200
- Pharyngeal (or branchial) arches, 114–115, 116*f*, 117*t*
- Phe508del mutation, 287  
 contribution of, 287*t*
- Phenocopy, 71
- Phenol enhanced reassociation technique, 44
- Phenotypes, 1. *see also* Genotype-phenotype correlations  
 McLeod phenotype, 44  
 possible genotypes, phenotypes, and gametes formed from alleles at ABO locus, 75, 75*t*
- Phenylalanine metabolism, disorders of, 255–258
- Phenylketonuria, 150*t*, 227, 255–258, 257*f*  
 diagnosis of, 255–257  
 heterozygote advantage in, 88*t*  
 maternal, 257–258  
 mutational basis of, 257  
 neonatal screening for, 147–148, 150  
 treatment of, 205*t*, 255
- Phenytol, teratogenic effects of, 225*t*
- Pheochromocytoma, 196*t*
- Philadelphia (*Ph*<sup>1</sup>) chromosome, 180
- Phocomelia, 225–226, 226*f*
- Physical agents, as teratogens, 227
- PI3K/AKT/mTOR pathway, 206*f*, 282*f*
- PIC. *see* Polymorphic information content (PIC)
- Piebaldism, 119*t*
- Pierre-Robin sequence, 117*t*
- Pink-eyed dilution, 258
- Pitt-Hopkins syndrome, 231, 233*f*
- PJS. *see* Peutz-Jegher syndrome (PJS)
- Placental biopsy, 306
- Placental mosaicism, confined, 311
- Plasma cells, 166–167
- Plasmodium falciparum* malaria, 84–85, 87
- Platelet-derived growth factor α gene* (*PDGFRA*), 224
- Pleiotropy, 66–68
- Point mutations, 180–181
- Polarity, 103, 112–113
- Poly(A) tail, 15
- Polyadenylation, 15, 17
- Polyadenylation signal mutations, 160
- Polyasplenia, 112–113
- Polycystic kidney disease, 117*t*  
 inheritance pattern of, 318*t*  
 tissue transplantation for, 206  
 treatment for, 205*t*
- Polydactyly, 1–2, 220*t*  
 short-rib polydactyly syndrome, 115, 117*t*, 119*f*  
 synpolydactyly, 110*f*–111*f*  
 ultrasonographic image, 304*f*
- Polygenes, 132
- Polygenic conditions, 5
- Polygenic inheritance, 4, 132–133
- Polymerase chain reaction (PCR), 50, 51*f*  
 amplification-refractory mutation system (ARMS), 55–56, 56*f*  
 droplet digital, 56  
 quantitative fluorescent, 62, 63*f*  
 real-time, 56, 58*f*
- Polymorphic alleles, 91
- Polymorphic information content (PIC), 88
- Polymorphism association studies, 131–132
- Polymorphisms  
 DNA sequence polymorphisms, 50–52  
 genetic, 88  
 HLA, 170–171  
 restriction fragment length polymorphisms, 50–51  
 single nucleotide polymorphisms (SNPs), 42, 50–52, 203
- Polypeptide, 15
- Polyploidy, 35
- Polyposis syndromes, 191–192
- Polyribosomes, 15
- Polysomes, 15
- Pompe disease (GSD II), 260
- Population carrier screening, 151–152, 151*t*
- Population genetics, 83–93, 93*b*
- Populations  
 allele frequencies in, 83–88, 83*f*  
 large, 87–88, 88*t*  
 small, 87
- Population screening, 147–148  
 ethical dilemmas and, 329–330  
 negative aspects of, 152  
 positive aspects of, 152
- Porphyrias  
 erythropoietic, 266  
 hepatic, 266  
 treatment for, 205*t*

- Porphyria variegata, 66, 68f, 266
- Porphyrin metabolism, disorders of, 266, 267f
- Position-independent identification, of human disease genes, 42–43, 43f
- Positional candidate gene, 42–43
- Positional cloning, 42–44
- Positional effects, 121, 121t
- Posterior encephalocele, ultrasonographic image, 308f
- Posterior information, 94
- Postnatal screening, 149–151, 149f
- Postreplication repair, 22, 22t
- Posttranslational modification, 15
- Potassium channel gene *KCNJ11*, 203
- Potter sequence, 218, 219f
- Prader-Willi syndrome (PWS), 78, 78f, 122, 244
  - genomic imprinting in, 77–78
  - molecular organization, 78, 78f
  - uniparental disomy in, 77
- Precision medicine, 202
- Predictive testing
  - in childhood, 326
  - ethical considerations in carrier detection and, 147
- Pre-embryonic stage, 102, 102t
- Pregnancy
  - abnormalities identified in, 311
  - spontaneous loss due to congenital abnormalities, 215
  - termination of, 312
- Preimplantation genetic diagnosis (PGD), 313
  - genetic conditions for, 313t
- Preimplantation genetic haplotyping, 313
- Premutation, 241–242
- Prenatal diagnosis, ethical dilemmas in, 325–326
- Prenatal life stages, 102, 102t
- Prenatal screening, 149–151, 149f, 306–309
  - Bayes' theorem and, 99–100
- Prenatal testing
  - indications for, 309–311
  - non-invasive, 314–315
  - special problems in, 311–312
  - techniques used in, 303–306, 303t
  - unexpected chromosome result, 311–312
- Prenatal treatment, 315
- Presenilin-1* gene (*PSEN1*), 106–107, 142
- Presenilin-2* gene (*PSEN2*), 142
- Prevalence, 5
- Primary ciliary dyskinesia (Kartagener syndrome), 112–113, 117t
- Primary idiopathic gout, 265
- Primary inherited disorders, of immunity, 171–173
- Probability, 94
  - Bayesian calculations, 95, 95t–96t, 99t–100t
  - conditional, 94
  - joint, 94
  - posterior or relative, 94
  - prior, 94
- Probability theory, 94–95
- Proband, 66
- Programmed cell death, 104
- Prolonged hyperthermia, 227
- Prometaphase, 29
- Promoter mutations, 18t
- Properdin, deficiency of, 171
- Prophase, 29, 30f
- Prophase I, 30–32
- Prophylactic surgery, for familial cancer-predisposing syndromes, 198t
- Propionic acidemia, treatment for, 205t
- Propionic acidurias, 259–260
- Proposita, 66
- Propositus, 66
- Prostate cancer, 193
  - chromosomal location of, 183t
- Protease inhibitor (PI), 288
- Protein
  - functional effects of mutations on, 20–21
  - posttranslational modification, 15
  - structural effects of mutations on, 19–20
- Protein replacement, for treatment of genetic disease, 205, 205t
- Protein tyrosine phosphatase, non-receptor-type, 11 (*PTPN11*) gene, 221
- Proteomics, 46
- Proteus syndrome, 279
- Proto-oncogenes, 179
- Proximal myotonic myopathy, 286
- 'Proxy,' testing by, 326–327
- Prusiner, Stanley, 7t
- Pseudoautosomal region, 74
- Pseudodominance, 70, 70f
- Pseudogenes, 12
- Pseudohypertrophy, 282, 283f
- Pseudoxanthoma elasticum (PXE), 295, 296f
- Pseudomosaicism. *see* Mosaicism, level 1
- Psychodynamic approach, in genetic counseling, 319
- PTEN* gene, 193
- PTPN11* gene, 221t
- Public interest, ethical dilemmas and, 327–330
- Pulmonary arterial hypertension (PAH), 288
- Punnett square, 2, 2f
- Purine metabolism, disorders of, 265–266
- Purine nucleoside phosphorylase deficiency, 266
- Purines, 9
- PWS. *see* Prader-Willi syndrome (PWS)
- PXE. *see* Pseudoxanthoma elasticum (PXE)
- Pyrimidine metabolism disorders, 266
- Pyrimidines, 9
- Pyrosequencing, 57, 60f
- Q**
- QF-PCR. *see* Quantitative fluorescent PCR (QF-PCR)
- Quantitative fluorescent PCR (QF-PCR), 62, 63f, 304–306, 305f
- Quantitative genetics, 132
- Quantitative inheritance, 5
- R**
- Radiation, 21–22
  - average doses, 21, 21t
  - gonad dose, 21
  - ionizing, 21
  - teratogenic effects of, 227
- Radiography, 306
- RAG1/RAG2*, 173
- Ramakrishnan, Venkatraman, 7t
- Random genetic drift, 85, 85f
- Rapamycin, repurposing of, 205
- RAS* gene, 187
- RAS*-MAPK pathway, 222f
  - genes of, syndromes associated to, 221, 221t
- RAS* proteins, 180–181
- RBI* gene, 183
- Reading frame, 16
- Real-time PCR, 56, 58f
- Recessive characteristics, 2
- Recessive disorders, X-linked, 93
- Reciprocal translocations, 28f, 35–36, 36f
- Recombinant DNA technology
  - biosynthetic products from, 206–207, 206t
  - therapeutic applications of, 206–207, 206t
- Recombination, 30–31, 145
- Recombination fraction, 90
- Recurrence risk, 94
  - calculating and communicating, 318
  - empiric, 100–101, 100t
  - estimation of, 94
- Recurrent miscarriage, 254
- Reduced penetrance, 69, 69f, 95–96, 95f–96f
- Reference panels, 137
- Registers, genetic, 152, 152b
- Regression coefficient, 5
- Regression to the mean, 133
- Regulation, of gene therapy, 207
- Regulome, 46–47
- Renal cancer, 196t
- Renal disorders, monogenic, 296–298, 298t–299t
- Renal dysgenesis, 223b
- Replication bubbles, 10, 11f
- Replication forks, 10
- Replication units, 10
- Reproductive genetics, 303–315, 316b
- Research
  - genetic, informed consent in, 327b
  - stem cell, ethical dilemmas and, 330
- Resemblance, degree of, 132t, 133
- Respiratory disorders, monogenic, 286–289
- Response elements, 16
- Restriction endonucleases, 51, 51t
  - cleavage points of, 51, 51f
- Restriction fragment length polymorphisms, 50–51
  - for mutation detection, 55, 56f
- RET* gene, 21, 113, 119t
- RET* proto-oncogene, 113, 119–120, 119t, 121f
- Retinal angioma, 196t
- Retinitis pigmentosa, 318f
  - abnormalities in, 144t
  - inheritance pattern of, 317–318, 318t
  - mesenchymal stem cell therapy for, 213
- Retinoblastoma, 182–183, 182f, 245
  - chromosomal location of, 183t
  - tumor suppressor mutations in, 187t
  - 'two-hit' hypothesis in, 182–183, 182f–183f
- Retinoids, teratogenic effects of, 225t

- Retroviral oncogenes, 179  
 Retroviruses, 179, 179f  
 Reverse genetics, 43  
 Reverse transcriptase, 12  
 Revised Amsterdam criteria, for Lynch syndrome, 197  
 Revised Bethesda guidelines, for colorectal cancer, 197  
 Rh blood group, molecular basis of, 175  
 Rhabdomyosarcoma  
   alveolar, 119t  
   chromosomal location of, 183t  
 Rhesus blood group, 175  
 Rhesus hemolytic disease, of newborn, 175  
 Rheumatoid arthritis, HLA and, 170t  
 Rhizomelic chondrodysplasia punctata, 269  
 Ribonuclease-containing RNA-induced silencing complex (RISC), 17  
 Ribonuclease L gene (*RNASEL*), 193  
 Ribonucleic acid. *see* RNA (ribonucleic acid)  
 Ribosomal RNA, 15  
 Ribosomes, 9  
 Rickets, vitamin D-resistant, 73  
   treatment for, 205t  
 Ring chromosomes, 39–40, 40f  
 RISC. *see* Ribonuclease-containing RNA-induced silencing complex (RISC)  
 Risk  
   empiric, 100–101  
   nature of, 318  
   numerical value of, 318  
   placing in context, 318  
   presenting, 318  
 Risk calculation, 94–101, 101b, 318  
   with autosomal dominant inheritance, 95–97  
   with autosomal recessive inheritance, 97–98, 97f  
   with sex-linked recessive inheritance, 98–99, 98f  
*RIT1* gene, 221t  
 RNA-directed DNA synthesis, 17  
 RNA interference (RNAi), 210, 211f  
   pathway, 17  
 RNA modification, 210  
   antisense oligonucleotides, 210  
   mutations, 160  
 RNA processing, 14–15  
 RNA (ribonucleic acid), 9  
   5' cap, 15  
   5' capping, 15  
   microRNAs (miRNAs), 17  
   small interfering RNAs (siRNAs), 17, 210, 211f  
 RNAi. *see* RNA interference (RNAi)  
 Roberts, Richard, 7t  
 Roberts syndrome, 220t  
 Robertsonian translocations, 36–37, 38f  
   in Down syndrome, 237  
   risks in, 37  
 Rocker-bottom foot, 309, 310f  
 Rogers, Carl, 319  
*ROM1* gene, 75  
 Romano-Ward syndrome, 289  
 Rous, Peyton, 7t  
 RSS. *see* Russell-Silver syndrome (RSS)  
 Rubella, 227, 227t  
 Rubenstein-Taybi Syndrome, 107, 110f  
 Russell-Silver syndrome (RSS), 80, 81f, 122  
   genomic imprinting in, 77–78  
   molecular organization of, 80f  
 Ryanodine receptor (*RYR1*) gene, 202  
 Ryukyuan islands, 87t  
 'Ryukyuan' spinal muscular atrophy, 87t  
**S**  
*SALL4* gene  
   in limb, as developmental model, 118  
   in Okhiro syndrome, 225–226  
 Sample failure, 311  
 Samples, DNA, 145  
 San Blas Indians, recessive disorders that are common in, 87t  
 Sanfilippo syndrome (MPS III), 264  
 Sanger, Frederick, 5–6, 6f, 7t  
 Sanger sequencing, 5–6, 57, 58t  
 Satellite DNA, 13  
 Satellites, 25  
 SCA gene, 19  
 Scenario-based decision counseling, 319  
 Schizoid disorder, 141, 141t  
 Schizophrenia, 141–142  
   epidemiology of, 141  
   evidence for genetic factors, 141t  
   family and twin studies for, 141  
   first-degree relatives of individuals with, 141t  
   heritability estimates of, 132t  
   susceptibility genes for, 141–142  
 Schwannomatosis, 280  
 SCID. *see* Severe combined immunodeficiency (SCID)  
 Sclerosteosis, 87t  
 Screening. *see also* Testing  
   for breast cancer, 197  
   carrier, 151–152, 151t  
   cascade screening, 152  
   for colorectal cancer, 197  
   for congenital adrenal hyperplasia, 148t  
   for familial cancer, 194–198, 195b  
   family, 144  
   for genetic disease, 144–153, 152b  
   heterozygote, 144  
   newborn, 149–150  
   for ovarian cancer, 197–198  
   population, 147–148  
   population carrier, 151–152, 151t  
   positive predictive value of tests, 148  
   postnatal, 149–151, 149f  
   prenatal, 99–100, 149–151, 149f, 306–309  
   sensitivity and specificity of, 148, 148t  
   of those at high risk, 144  
   two-step, 152  
 Screening programs, 147b, 148–149  
   criteria for, 148–149, 148b  
 Secondary findings, ethical dilemmas and, 327, 328b  
 Secondary spermatocytes, 32  
 Sedláčková, Eva, 245  
 Segmentation, 104  
 Segregation  
   2:2, 36, 36t, 37f  
   3:1, 36, 36t  
   analysis of, 88–89  
   law of, 3  
   at meiosis, 34f, 35, 38–39  
   patterns of, 36t  
 Selection, 84–85  
 Senior-Loken syndrome, 117t  
 Sensenbrenner syndrome (cranioectodermal syndrome), 117t  
 Sensitivity, 148, 148t  
 Sensorineural hearing loss, inheritance  
   pattern of, 317–318, 318t  
 Septic shock, 165  
 Sequence abnormalities, 218, 219f  
 Sequencing  
   of human genome, 46  
   next-generation, for monogenic disorders, 47–48  
 Sequencing-based methods, 57–58  
 Sequencing by synthesis, 58  
 Serine threonine kinases, cytoplasmic, 181  
 SETD5-associated mental retardation, 234, 235f  
 Severe combined immunodeficiency (SCID), 173  
   gene therapy for, 208  
   treatment for, 205t  
   X-linked, 205t  
 Sex chromatin, 30, 122  
 Sex chromosomes, 25–26, 26f  
   disorders of, 239–243  
 Sex determination, 123–127, 126f  
 Sex influence, 74  
 Sex limitation, 74  
 Sex-linked inheritance, 66, 71–74  
 Sex-linked recessive inheritance, 98–99, 98f  
 Sexual ambiguity, 254  
 Sharp, Phillip, 7t  
 SHFM. *see* Split-hand-foot malformation (SHFM)  
*SHOC2* gene, 221t  
 Short-chain acyl-CoA dehydrogenase deficiency, 269  
 Short interspersed nuclear elements, 13  
 Short-rib polydactyly syndrome, 117t, 119f  
 Short stature homeobox (*SHOX*) gene, 74, 240–241  
 Siamese twins, 128  
 Sickle cell anemia, 84–85  
 Sickle cell crisis, 158  
 Sickle cell disease, 158–159, 158f  
   clinical aspects of, 158  
   heterozygote advantage in, 84–85, 88t  
   mutational basis of, 159  
   neonatal screening for, 150t, 151  
   population carrier screening for, 151  
 Sickle cell trait, 84–85, 158–159  
 Sickling, 158  
 Sigmund, Freud, 319  
 Signal transduction, 16, 181f, 182  
   intracellular, 181  
 Signal transduction ('signaling') genes, 113–114  
 Silent mutations, 18t, 19  
 Single-copy genes, unique, 12  
 Single-gene defects, malformations due to, 220  
 Single-gene disorders, 4, 42, 142. *see also* Monogenic disorders  
   Alzheimer disease, 142  
   family history of, 310

- Single nucleotide polymorphisms (SNPs), 42, 50–52, 203
- siRNAs. *see* Small interfering RNAs (siRNAs)
- Sister chromatid exchange, 253, 253f
- Size analysis, of PCR products, 55, 55f
- Skeleton, axial, 105–107
- 'Skips a generation', 69
- Slipped strand mispairing, 13
- Sly syndrome (MPS VII), 264
- SMA. *see* Spinal muscular atrophy (SMA)
- SMAD2* gene, 187
- SMAD4* gene, 187, 192
- Small interfering RNAs (siRNAs), 17
- Small nuclear ribonucleoprotein polypeptide N (*SNRPN*) gene, 78, 78f
- Small nuclear RNA (snRNA), 14–15
- SMC1A-associated EIEE, 235
- Smith, Hamilton, 7t
- Smith-Lemli-Opitz syndrome (SLOS), 107  
holoprosencephaly in, 222–223
- Smith-Magenis syndrome, 247, 248f
- Smithies, Oliver, 7t
- SMN* genes, 278, 278f
- SMN1* genes, 278
- SMO* genes, 107
- Smoothed (Smo), 107
- Snell, George, 7t
- SNPs. *see* Single nucleotide polymorphisms (SNPs)
- Societal intervention, 92–93
- Soft markers, 312
- Solenoid model of chromosome structure, 11, 11f
- Somatic cell gene therapy, 207
- Somatic cells, 177  
mutations in, 182–183
- Somatic genetic disease, acquired, 5
- Somatic mosaicism, 40, 40f, 76
- Somatic mutations, 17
- Somatic rearrangements, 120–121
- Somatogenesis, 105–107, 105f
- Sonic hedgehog-Patched GLI pathway, 107, 108f
- Sonic hedgehog (*SHH*) gene, 107, 223  
in limb, as developmental model, 107
- SOS1* gene, 221t
- Sotos syndrome, 221–222, 224f
- Southern, Edwin, 53
- Southern blotting, 53, 53f–54f
- Specialist investigation, 146, 146f
- Specific acquired immunity, 164, 166–171  
disorders of, 172–173
- Specificity, 148, 148t
- Spermatocytes, secondary, 32
- Spermatogenesis, 32–33, 33f
- S phase, 30, 30f
- Spherocytosis, hereditary, treatment for, 205t
- Sphingolipidoses, 264–265
- Spina bifida, 223b  
familial risk of, 134
- Spinal muscular atrophy (SMA), 277–278  
clinical features of, 277–278  
different forms of, 277b  
type I, 277, 277b  
type II, 277, 277b  
type III, 277b, 278  
type IV, 277b
- Spinocerebellar ataxia, 19, 274–275  
genetics of, 275
- Spinocerebellar ataxia 1 (*ATXN1*), 19t
- Spinocerebellar ataxia 2 (*ATXN2*), 19t
- Spinocerebellar ataxia 3 (*ATXN3*), 19t
- Spinocerebellar ataxia 6 (*CACNA1A*), 19t
- Spinocerebellar ataxia 7 (*ATXN7*), 19t
- Spinocerebellar ataxia 8 (*ATXN8*), 19t
- Spinocerebellar ataxia 12 (*PPP2R2B*), 19t
- Spinocerebellar ataxia 17 (*TBP*), 19t
- Splice site mutations  
effects on protein product, 18t  
frequency of, 18t
- Splice sites, cryptic, 20
- Splicing, alternative, 17
- Splicing mutations, 20
- Split-hand-foot malformation (SHFM), 103–104, 104f
- Spotch*, 42–43
- Spontaneous abortions, chromosomal abnormalities in, 236t
- Spontaneous miscarriages, 6  
due to congenital abnormalities, 215
- Spontaneous mutations, 21
- Sporadic congenital neutropenia, 172
- SRY* gene, 109, 123–125, 124b
- SRY*-type HMG box (*SOX*) genes, 109–110  
*SOX1*, 109  
*SOX2*, 109  
*SOX3*, 109  
*SOX9*, 109, 121t  
*SOX10*, 109
- STAT3* gene, 173
- Steitz, Thomas A., 7t
- Stem cell research, ethical dilemmas and, 330
- Stem cell therapy, 210–213, 211f  
embryonic, 212  
embryonic stem cells for, 212  
induced pluripotent, 213  
and limbal stem cells, 213  
mesenchymal, 213
- Stem cells, ethical dilemmas and, 330
- Steroid metabolism, disorders of, 261–262, 261f
- Steroid sulfatase, 122–123
- Stillbirth, unexplained, 254
- STK11* gene, 192
- Stop or termination codons, 16
- Stratified medicine, 202
- Streptococcus pneumoniae*, 3–4
- Streptomycin, teratogenic effects of, 225t
- Stroke-like episodes, 271
- Substitutions, 17–18, 18t  
conservative, 20  
non-conservative, 20
- Sulfonylureas, repurposing of, 205
- Sulphur amino acids, metabolism of, disorders of, 258
- Sulston, John, 7t
- Support, 319
- Support groups, patient, 319
- Sutton, Walter, 3
- Synapsis, 31–32
- Synaptonemal complexes, 31–32
- Synpolydactyly, 108–109, 111f
- Syntenic region, 114–115
- Synteny, 42–43
- Syphilis, 227t
- Systemic lupus erythematosus, HLA and, 170t
- Szostak, Jack, 7t
- T**
- T-box (*TBX*) genes, 110–112  
*TBX3*, 110–112  
*TBX5*, 110–112
- T-cell surface antigen receptor, 169–170
- T cells, 169, 169f
- T helper cells, 169
- Talipes, 223b
- Talipes equinovarus, 217f
- TAR syndrome, Thrombocytopenia-absent radius (TAR) syndrome
- Tarceva (Erlotinib), 204, 204t
- Targeted gene correction, 210
- Tay-Sachs disease, 87t, 264–265  
heterozygote advantage in, 88t  
population carrier screening for, 151t
- TAZ* gene, 81
- TBX1* gene, 114–115
- TCOF1* gene, 69, 69f
- Telomere length, cancer and, 185–186, 186f
- Telomeres, 25
- Telomeric DNA, 13
- Telophase, 29, 30f
- Telophase I, 31f, 32
- Telophase II, 31f
- Temin, Howard, 7t
- Teratogens, 225–228
- Termination codons, 16
- Termination of pregnancy, 312
- Terminology  
for family studies, 66  
symbols used in family studies, 67f
- Test for Capacity, 325b
- Testing, 148. *see also* Carrier testing;  
Genetic testing; Predictive testing;  
Prenatal testing  
biochemical, 146–147  
direct mutation, 147  
inadvertent, 326–327  
presymptomatic, 144  
by 'proxy', 326–327
- Testis-determining factor, 123
- Tetracycline, teratogenic effects of, 225t
- Tetraploidy, 35
- Tetrasomy, 33
- Thalassemia, 159  
heterozygote advantage in, 87, 88t  
neonatal screening for, 151  
population carrier screening for, 151  
treatment for, 205t
- $\alpha$ -Thalassemia, 159–160, 159f  
forms of, 159  
mutational basis of, 159–160, 159f  
population carrier screening for, 151
- $\beta$ -Thalassemia  
chain termination mutations in, 160  
clinical aspects of, 160, 161f  
missense mutations in, 160  
mRNA splicing mutations in, 160  
mutational basis of, 160, 160f  
polyadenylation signal mutations, 160  
population carrier screening for, 151  
RNA modification mutations in, 160  
transcription mutations in, 160



- $\delta\beta$ -Thalassemia, 160–161  
   mutational basis of, 161, 161f  
 Thalassemia intermedia, 161  
 Thalassemia minor, 160  
 Thalassemia trait, 160  
 Thalidomide, teratogenic effects of, 225–226, 225t  
 Thalidomide embryopathy, 226f  
 Thanatophoric dysplasia, 113–114, 113f, 113t, 217–218, 218f  
 Thiopurine methyltransferase, 202  
 Thiopurine methyltransferase (*TPMT*) gene, 202  
 Thoracolumbar myelomeningocele, 217f  
 Thousand genomes project, 137  
 Thrombocytopenia-absent radius (TAR) syndrome, 248–249, 249f  
 Thyroid carcinoma, 119t  
 Thyroid-stimulating hormone, 150–151  
 Thyrotoxicosis, HLA and, 170t  
 Tissue transplantation, 206  
 TLR. *see* Toll-like receptor (TLR)  
*TNFSF5*, 172  
 Toll-like receptor (TLR)  
   pathway, 164–165, 165f  
   TLR2, 164–165  
 Tonegawa, Susumu, 7t  
 Townes-Brock syndrome, 117t  
 Toxoplasmosis, 227, 227t  
*Tp53* gene, 183–185  
   in colorectal cancer, 187  
*TP63* gene, 118  
 Trace elements, metabolism of, disorders of, 266–268  
 Transcription, 14–15, 14f  
   control of, 16  
   enhancers, 16  
   mutations in  $\beta$ -thalassemia, 160  
   silencers, 16  
 Transcription factors, 17, 103  
 Transcriptomics, 46  
 Transfer RNA (tRNA), 4, 15  
 Transforming growth factor- $\beta$  (TGF- $\beta$ ) gene family, 104  
   biological response to, 105f  
   in development and disease, 105  
   groups, 105  
 Transforming growth factor- $\beta$  receptor 2 gene (*TGFBR2*), 293  
 Transforming principle, 3–4  
 Transitions, 17–18  
 Translation, 15, 15f  
 Translesion DNA synthesis, 22  
 Translocation breakpoints, chromosomal, oncogenes at, 179–180  
 Translocations, 35–37  
   chromosome painting of, 28f  
   in Down syndrome, 37  
   reciprocal, 35–36  
   Robertsonian, 36–37, 38f  
   types of, 35f  
   X-autosome, 73, 73f  
 Transmission/disequilibrium test, 91  
 Transplantation genetics, 170  
 Transposons, 13  
 Transversions, 17–18  
 Trastuzumab(Herceptin), 204t  
 Treacher-Collins syndrome, 69, 69f, 117t  
 Trilaminar disc, 102, 103f  
 Triple test, 303t  
   for Down syndrome, 308  
 Triplet codons, 16  
 Triplet repeat expansions, 18–19, 19t  
 Triploidy, 35, 35f, 238–239  
 Trisomy, 33–34  
 Trisomy 13. *see* Patau syndrome (trisomy 13)  
 Trisomy 16, 33  
 Trisomy 18. *see* Edwards syndrome (trisomy 18)  
 Trisomy 21. *see* Down syndrome (trisomy 21)  
 tRNA. *see* Transfer RNA (tRNA)  
 Trophoblast, 103, 121  
 Trypsin, immunoreactive, 151  
 Trypsinogen deficiency, treatment for, 205t  
 Tuberosus sclerosis, 66–68, 68f, 146, 146f, 182, 280–281, 281f  
   clinical features of, 280–281, 281b  
   genetics of, 281  
 Tuberosus sclerosis complex  
   clinical examination of, 146  
   imaging of, 146, 146f  
 Tumor suppressor genes, 182–185  
   in retinoblastoma, 183  
 Tumor suppressors, 182  
 Turcot syndrome, 192–193  
 Turner syndrome (45, X), 4–5, 34, 73, 122, 240–241  
   chromosome findings in, 241, 241t  
   clinical features of, 240–241, 240f  
 Twin studies, 131  
   of Alzheimer disease, 142  
   of cancer, 178  
   of coronary artery disease, 140  
   of schizophrenia, 141, 141t  
 Twinning, 127–129  
 ‘Two-hit’ hypothesis, in retinoblastoma, 182–183, 182f–183f  
 Two-step screening, 152  
 Tyrosine metabolism, disorders of, 255–258
- U**  
 Ubiquitin ligase gene *UBE3A*, 78–79, 78f  
 UK Human Tissue Act, 324  
 Ultrasonography, 303–304, 303t  
   for Down syndrome, 308–309  
   fetal anomaly scanning, 309  
   findings in chromosome abnormality, 310t  
   soft markers on, 312  
 Uniformity, law of, 3  
 Uniparental disomy, 77, 77f  
 Uniparental heterodisomy, 77  
 Universal donors, 175  
 Universal recipients, 175  
 Universality, 325  
 Urea cycle disorders, 258, 259f  
   treatment for, 205t  
 Uridine diphosphate glycosyltransferase 1(*UGT1A1*) gene, 204  
 Utrophin, 206
- V**  
 VACTERL association, 219  
 Valproic acid  
   fetal valproate syndrome (FVS), 227, 228f  
   teratogenic effects of, 225t  
 Van der Woude syndrome, 218, 219f, 220t  
 Variable expressivity, 68–69  
 Variable number tandem repeats, 52  
 Variable (V) region, 168  
 Varicella zoster, 227t  
 Variegate porphyria, 87  
 Varmus, Harold, 7t  
 Velocardiofacial syndrome, 114–115, 245, 246f  
 Ventricular septal defect, 223b  
 Vestibular schwannomas, 280  
 Victoria, 71  
 Villefranche classification of Ehlers-Danlos syndrome, 294t  
 Viral agents, gene therapy and, 209  
 Vitamin D-resistant rickets, 73  
   abnormalities in, 144t  
   treatment of, 205t  
 VNTRs. *see* Variable number tandem repeats  
 von Gierke disease (GSD I), 260  
 von Hippel-Lindau disease, 182, 191t  
   chromosomal location of, 183t  
   screening for, 196t  
   tumor suppressor mutations in, 187t  
*V-onc*, *c-onc* and, relationship between, 179
- W**  
 Waardenburg syndrome, 42–43, 109, 112f  
   type 1, 119t  
 Waddington, Conrad, 121–122  
 WAGR syndrome, 243–244  
 Warfarin, teratogenic effects of, 225t  
 WAS. *see* Wiskott-Aldrich syndrome (WAS)  
 Watson, James, 3–4, 6, 7t, 9–10  
 Weinberg, W., 83  
 Werdnig-Hoffmann disease, 87t. *see also* Spinal muscular atrophy (SMA), type I  
 Whole-chromosome paint probes, 28  
 Wiedemann-Steiner syndrome, 231–232, 233f  
 Wieschaus, Eric, 7t  
 Wilkins, Maurice, 3–4, 6, 7t, 10  
 Williams syndrome, 246–247, 247f  
 Wilms tumor, 112, 119t, 243–244  
   chromosomal location of, 183t  
   tumor suppressor mutations in, 187t  
 Wilson disease, 267  
   treatment for, 205t  
*Wingless* (Wnt) gene, 104  
 Wiskott-Aldrich syndrome (WAS), 122, 174  
   treatment for, 205t  
 Wnt gene. *see* *Wingless* (Wnt) gene  
 Wolf-Hirschhorn syndrome, 37, 113–114, 243, 243f  
*WT1* gene, 112, 112t, 119t, 243–244
- X**  
 X-autosome translocations, 73, 73f  
 X-chromosomes  
   dosage compensation for, 123f  
   inactivation of, 122–123, 122f  
   mosaicism, 123  
   numerical, abnormalities, 73  
   skewed inactivation of, 72

- X-linked disorders  
 biochemical abnormalities in carriers, 144–145, 144t  
 carrier testing for, 144–145, 144t  
 clinical manifestations in carriers, 144–145
- X-linked dominant inheritance, 73–75, 73f–74f, 75b
- X-linked hydrocephalus, 277
- X-linked hypophosphatemia, 73
- X-linked immunodeficiencies, carrier tests for, 174, 174f
- X-linked intellectual disability (XLID), 229
- X-linked ocular albinism, fundus of carrier of, 145f
- X-linked recessive disorders  
 artificial selection against, 93  
 carrier detection for, 123  
 females affected with, 72–73  
 homozygosity for, 72
- X-linked recessive inheritance, 71–75, 71f, 75b  
 genetic risk in, 71, 71f–72f
- Xanthomata, 262, 262f
- Xeroderma pigmentosa, 252–253, 253f
- XIST gene, 122
- XLID. *see* X-linked intellectual disability (XLID)
- Xp21 muscular dystrophies, 281–284
- XXX females, 241
- XYY males, 241
- Y**
- Y-linked or holandric inheritance, 74–75, 75b
- Yonath, Ada E., 7t
- Z**
- Zamecnik, Paul, 4
- Zellweger syndrome, 268, 268f
- ZFNs. *see* Zinc-finger nucleases (ZFNs)
- ZIC2 gene, 112, 112t
- ZIC3 gene, 112, 112t
- Zinc finger, 112
- Zinc finger genes, 112–113, 112t
- Zinc finger motif, 17
- Zinc-finger nucleases (ZFNs), 210
- Zinc metabolism, disorders of, 268
- ZNF9 gene, 19, 286
- Zone of polarizing activity, 118
- Zygotene, 31–32, 31f
- Zygotene, 31–32, 31f